

KEMET Part Number: SN5-5501
(UALSN555010000)

KEMET, SN, AC Line Filters, Normal Mode, 0.08 mH

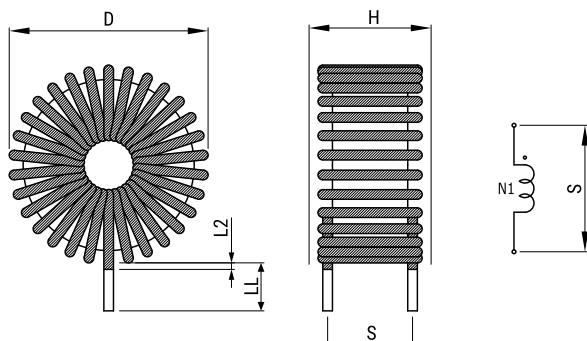

Dimensions

D	13mm MAX
H	7mm MAX
LL	20mm +/-2mm
S	7mm NOM
L2	1.6mm MAX
Wire Size	0.4mm

Packaging Specifications

Packaging:	Bulk
Component Weight:	2.6 g

General Information

Series:	SN
Style:	Through-Hole
Features:	Compact Size
RoHS:	Yes
Miscellaneous:	Temperature Rise Maximum: 45 K
Core:	Fe

Specifications

Inductance:	80 uH (0.1 MHz)
Current:	1 A
Temperature Range:	-25/+105°C
DC Resistance:	0.2 mOhms