

KEMET Part Number: SN16-500
(UALSN165000000)

KEMET
a YAGEO company

KEMET, SN, AC Line Filters, Normal Mode, 0.168 mH, MIN

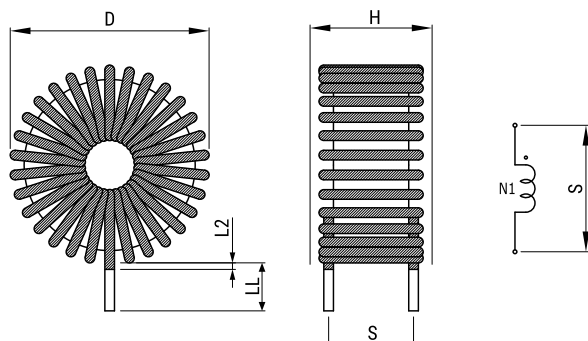

Dimensions

D	35mm MAX
H	21mm MAX
LL	20mm +/-2mm
S	16.5mm NOM
L2	1.5mm MAX
Wire Size	1.5mm

Packaging Specifications

Packaging:	Tray
Packaging Quantity:	250
Component Weight:	51.2 g

General Information

Series:	SN
Style:	Through-Hole
Features:	Compact Size
RoHS:	Yes
Miscellaneous:	36 (K) Temperature Rise Max.
Core:	Fe

Specifications

Inductance:	168 uH (0.1 MHz)
Inductance Tolerance:	MIN
Current:	8 A
Temperature Range:	-25/+105°C
DC Resistance:	31 mOhms

Statements of suitability for certain applications are based on our knowledge of typical operating conditions for such applications, but are not intended to constitute - and we specifically disclaim - any warranty concerning suitability for a specific customer application or use. This Information is intended for use only by customers who have the requisite experience and capability to determine the correct products for their application. Any technical advice inferred from this Information or otherwise provided by us with reference to the use of our products is given gratis, and we assume no obligation or liability for the advice given or results obtained.

KEMET
a YAGEO company