

SML-LX0303SIUPGUSB, Smallest RGB Surface Mount LED

ITW ECS Lumex announces the release of the smallest RGB Surface Mount LED. With the package size of 0.80 X 0.80 mm, these LEDs can be used for almost any indication that requires full spectrum colors in tight spaces. As new product designs become more compact and Engineers are becoming more creative, the ITW ECS Lumex SML-LX0303SIUPGUSB is your perfect LED solution.

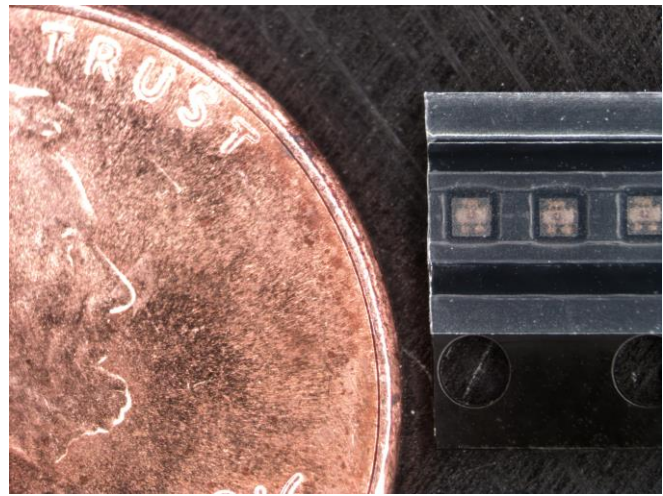
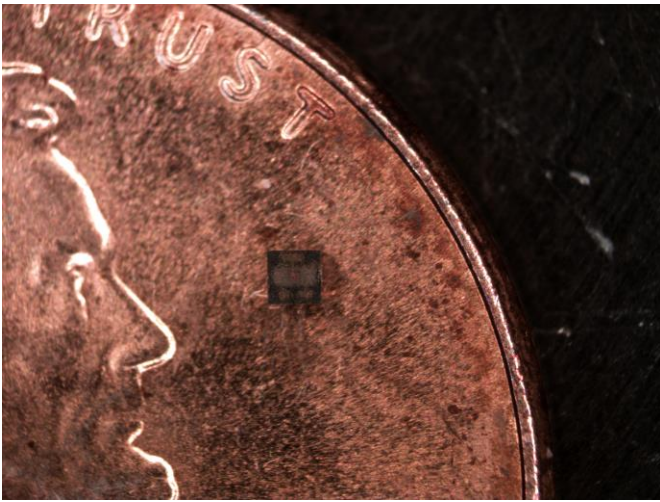

Product Features	Benefits
Very small footprint	25% size reduction from smallest RGB LED in market
Surface Mount	Offers assembly savings of up to 25%
Tape & Reel packaging	Easy mounting with pick and place process
Red, Green and Blue colors in single package	Can produce full spectrum of colors
Increased intensity of 50% compared to other LEDs	Greater visibility and clarity
Low current	Power saving

SML-LX0303SIUPGUSB, Smallest RGB Surface Mount LED

Technical Information & Drawing

PN	Emitted Color	Chip Material	Peak Wavelength (nm)	Lens Type	Typ. Vf	Intensity (mcd)		View Angle 2xTheta	If (mA)
						Min	Max		
SML-LX0303SIUPGUSB	Red	AlInGaP	625	Clear	2.0	12	20	120	3
	Green	InGaN	525	Clear	2.9	61	104	120	5
	Blue	InGaN	465	Clear	2.9	9	25	120	5

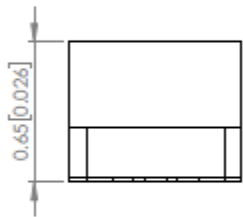
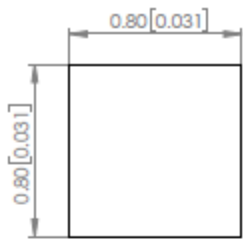

POLARITY

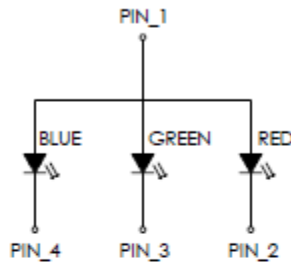

RECOMMENDED SOLDER PAD LAYOUT

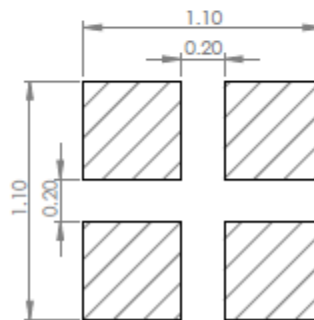
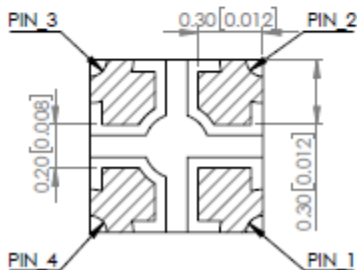

SML-LX0303SIUPGUSB, Smallest RGB Surface Mount LED

Markets	Applications
<ul style="list-style-type: none"> ▪ Medical ▪ Telecommunications ▪ Industrial Controls ▪ Appliance ▪ Security ▪ Wearables ▪ Transportation 	<ul style="list-style-type: none"> ▪ Portable medical diagnostics ▪ Routers, Switches, Indications ▪ Indications, controls & switches ▪ User-interface, switches, backlighting ▪ Switches & indications ▪ Indication, user-interface ▪ Switches, indications, backlighting

