

Type SMA-A series

Key Features

AEC-Q200 Compliance

Thin film technology

Excellent overall stability

Sn termination on Ni barrier layer

Tight tolerance down to $\pm 0.1\%$

Extremely low TCR down to ± 10 PPM/ $^{\circ}\text{C}$

SMD enabled structure

Lead-free and RoHS compliant

Applications

Automotive

Industrial

Telecommunication

Medical Equipment

Measurement/Testing Equipment



The SMA-A series is a metal film precision MELF resistor with an SMD enabled structure tight tolerance and low TCR. A sister to our SMA series The SMA-A series is AEC-Q200 Compliant

It comes in three sizes and six power ratings to 1W, is lead free and RoHS compliant.

Technical Specifications

Description	SMA-A0102		SMA-A0204		SMA-A0207	
Resistance range	8.2 Ω -1M Ω ; 0 Ω		0.1 Ω -3.4M Ω ; 0 Ω		0.1 Ω -3.4M Ω ; 0 Ω	
Resistance tolerance	See below					
Temperature coefficient	See below					
Operation mode	Standard	High Power	Standard	High Power	Standard	High Power
Power rating P ₇₀	0.2W	0.3W	0.25W	0.4W	0.5W	1W
Operating voltage U _{max}	200V	200V	200V	200V	300V	350V
Operating temperature range	-55 $^{\circ}\text{C}$ ~155 $^{\circ}\text{C}$					
Max. resistance change at P ₇₀ for resistance range, $\Delta R/R$ max., after 1000 h	$\leq 0.5\%$		$\leq 0.5\%$		$\leq 0.5\%$	

Construction and Dimensions

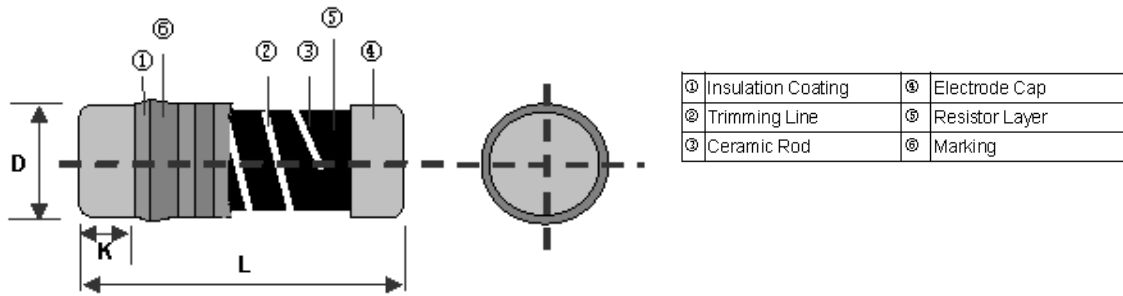

Type	L (mm)	ΦD (mm)	K (mm)	Weight 1,000EA (g)
SMA-A0102	2.20±0.10	1.10±0.10	0.45±0.05	7.7
SMA-A0204	3.50±0.2	1.40±0.15	0.8±0.1	18.7
SMA-A0207	5.90±0.2	2.20±0.20	1.3±0.1	80.9

Recommended Land Pattern

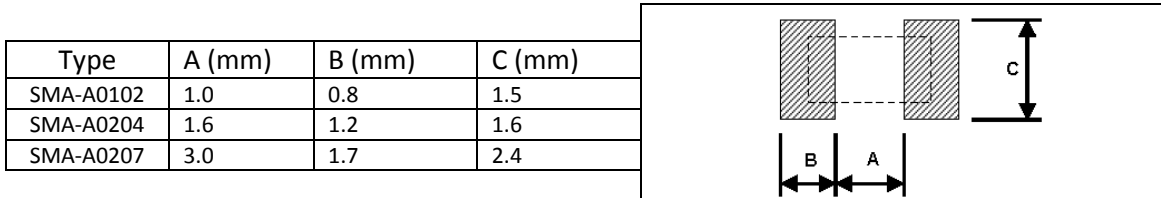

Soldering Condition

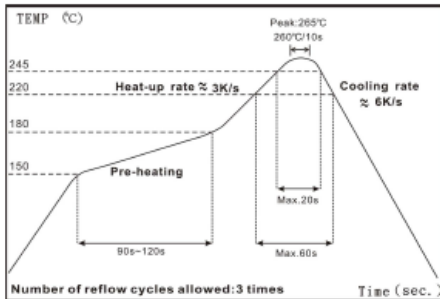

IR Reflow Soldering

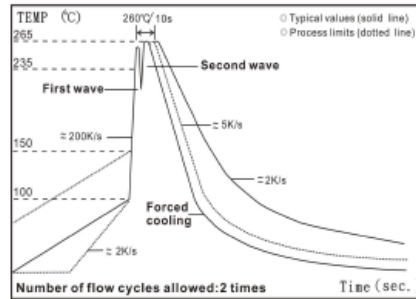

Wave Soldering (Flow Soldering)

- (1) Time of IR reflow soldering at maximum temperature point 260°C : 10s
- (2) Time of wave soldering at maximum temperature point 260°C : 10s
- (3) Time of soldering iron at maximum temperature point 410°C : 5s

Derating Curve

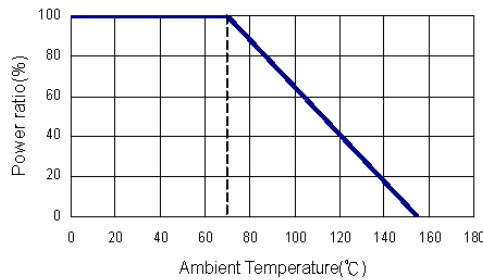

Standard Electrical Specifications

Size	Power Rating at 70°C	Max. Operating Voltage	Max. Overload Voltage	Resistance Range					TCR (PPM/°C)	
				±0.1%	±0.25%	±0.5%	±1%	±5%		
0102	0.2W	200V	400V	100Ω-56KΩ					-	±15
				-	100Ω-82KΩ	49.9Ω-200KΩ	49.9Ω-390KΩ	-	±25	
				-		.2Ω-1MΩ			±50	
				-			40Ω-1MΩ		±100	
	Jumper: 2A	0Ω(<15mΩ)					-	-		
0204	0.25W	200V	400V	49.9Ω-20KΩ					±10	
				10Ω-300KΩ					±15	
				10Ω-1MΩ		10Ω-3.4MΩ	4.02Ω-3.4MΩ		±25	
				10Ω-1MΩ	1Ω-1MΩ	1Ω-3.4MΩ	0.2Ω-3.4MΩ		±50	
	-			0.1Ω-1MΩ		±100				
Jumper: 2A	0Ω(<15mΩ)					-	-			
0207	0.5W	300V	600V	49.9Ω-20KΩ					±10	
				10Ω-300KΩ					±15	
				10Ω-1MΩ		10Ω-3.4MΩ	4.02Ω-3.4MΩ		±25	
				10Ω-1MΩ	1Ω-1MΩ	1Ω-3.4MΩ	0.2Ω-3.4MΩ		±50	
	-			0.1Ω-1MΩ		±100				
Jumper: 4A	0Ω(<15mΩ)					-	-			

High Power Rating Electrical Specifications

Size	Power Rating at 70°C	Max. Operating Voltage	Max. Overload Voltage	Resistance Range					TCR (PPM/°C)	
				±0.1%	±0.25%	±0.5%	±1%	±5%		
0102	0.3W	200V	400V	100Ω-56KΩ					-	±15
				-	100Ω-82KΩ	49.9Ω-200KΩ			±25	
				-		.2Ω-1MΩ			±50	
				-			40Ω-1MΩ		±100	
0204	0.4W	200V	400V	10Ω-300KΩ					±15	
				10Ω-1MΩ		10Ω-3.4MΩ	4.02Ω-3.4MΩ		±25	
				10Ω-1MΩ	1Ω-1MΩ	1Ω-3.4MΩ	0.2Ω-3.4MΩ		±50	
				-			0.1Ω-1MΩ		±100	
0207	1W	350V	700V	10Ω-300KΩ					±15	
				10Ω-1MΩ		10Ω-3.4MΩ	4.02Ω-3.4MΩ		±25	
				10Ω-1MΩ	1Ω-1MΩ	1Ω-3.4MΩ	0.2Ω-3.4MΩ		±50	
				-			0.1Ω-1MΩ		±100	

Operating Voltage= $v(P \cdot R)$ or Max. Operating Voltage listed above, whichever is lower
 Overload Voltage= $2.5 \cdot v(P \cdot R)$ or Max. Overload Voltage listed above, whichever is lower.
 RCWV(Rated Continuous Working Voltage)= $v(P \cdot R)$ or Max. Operating Voltage whichever is lower.
 Operating temperature range - -55°C~155°C

Derating Curve

Pulse withstanding capacity

The single impulse graph is the result of 50 impulses of rectangular shape applied at one-minute intervals. The limit of acceptance was a shift in resistance of less than 1% from the initial value. The power applied was subject to the restrictions of the maximum permissible impulse voltage graph shown

SMA-A Series Single Pulse(100 Ohm)

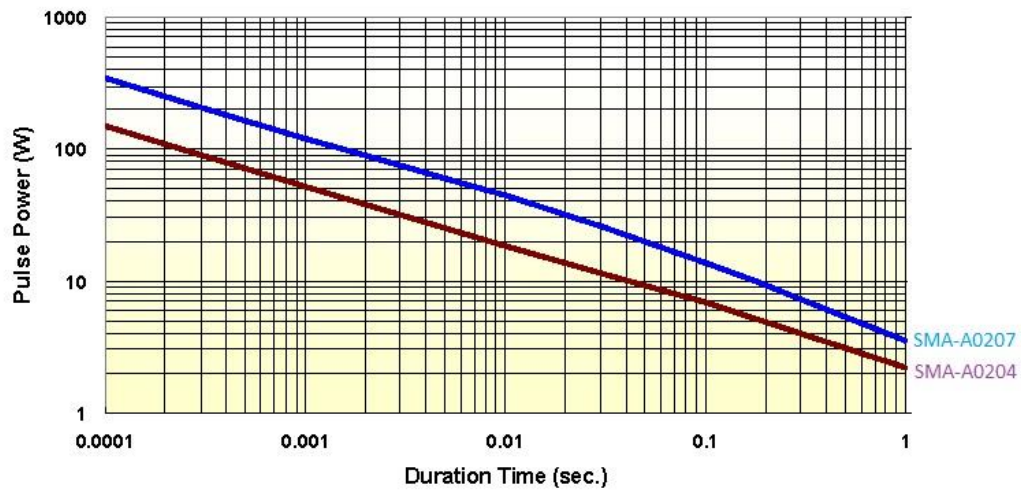

SMA-A0102 Series Single Pulse

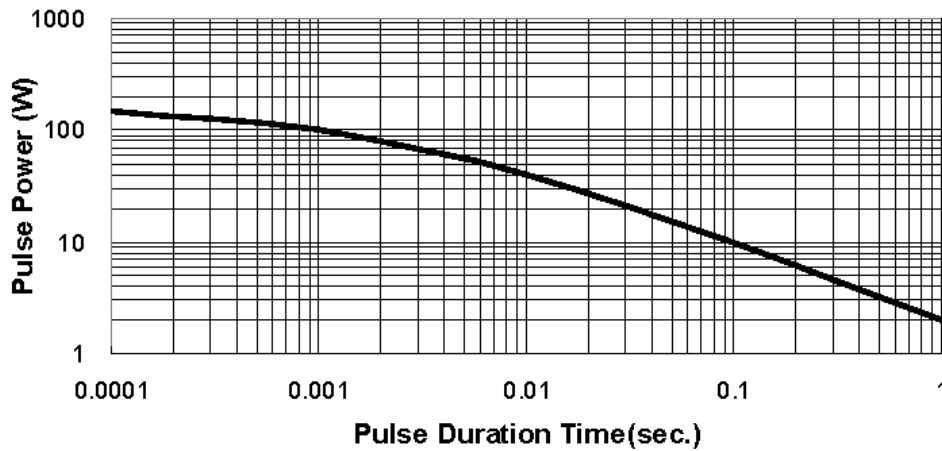

Continuous Pulse

The continuous load graph was obtained by applying repetitive rectangular pulses where the pulse period was adjusted so that the average power dissipated in the resistor was equal to its rated power at 70°C. Again the limit of acceptance was a shift in resistance of less than 1% from the initial value

SMA-A series Continuous Pulse (100 Ohm)

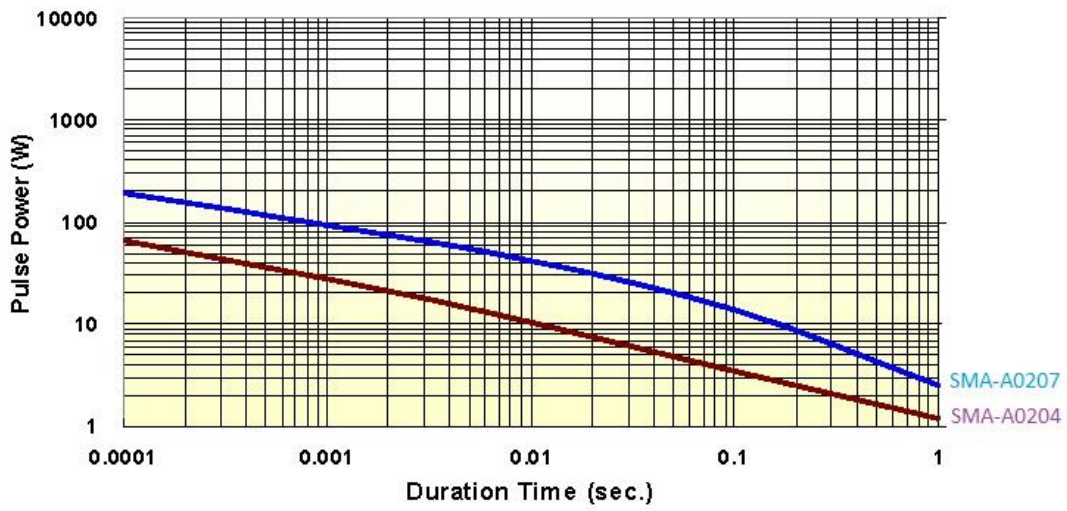

SMA-A series Pulse Voltage (100 Ohm)

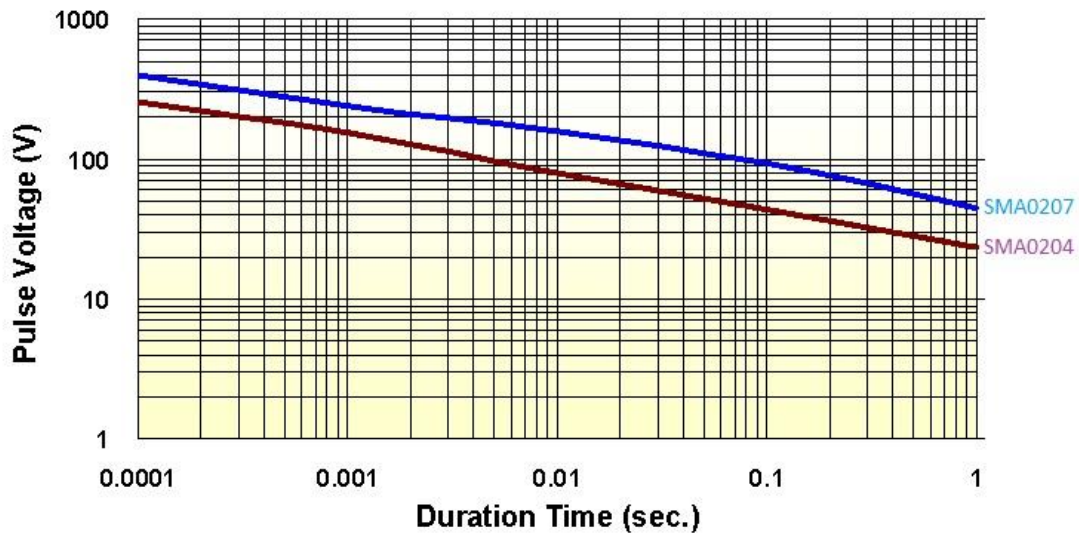

SMA-A0102 Continuous Pulse

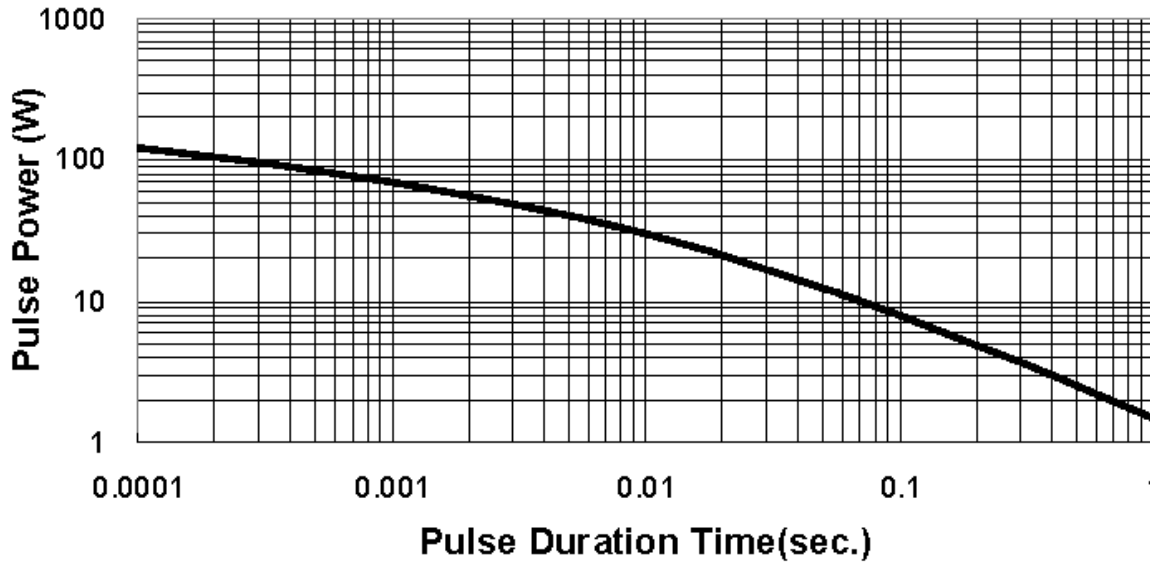

SMA-A0102 Pulse Voltage (100 Ohm)

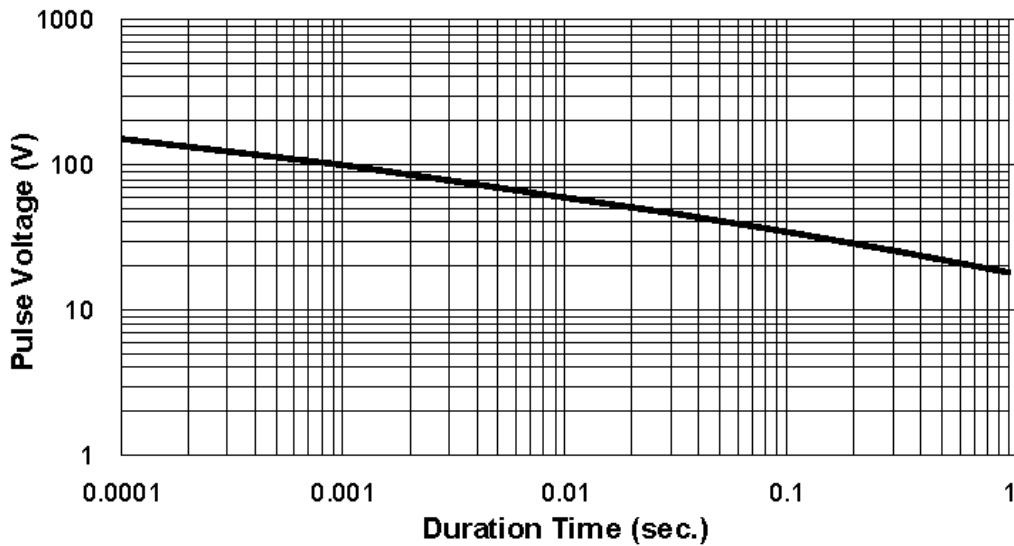

Frequency behaviour

Resistors are designed to function according to ohmic laws. This is basically true of resistors for frequencies up to 100kHz. At higher frequencies, there is an additional contribution to the impedance by an ideal resistor switched in series with a coil and both switched parallel to a capacitor. The values of the capacitance and inductance are mainly determined by the dimensions of the terminations and the conductive path length.

The environment surrounding components has a large influence on the behaviour of the component on the printed-circuit board.

Frequency Vs. Impedance

SMA-A0204

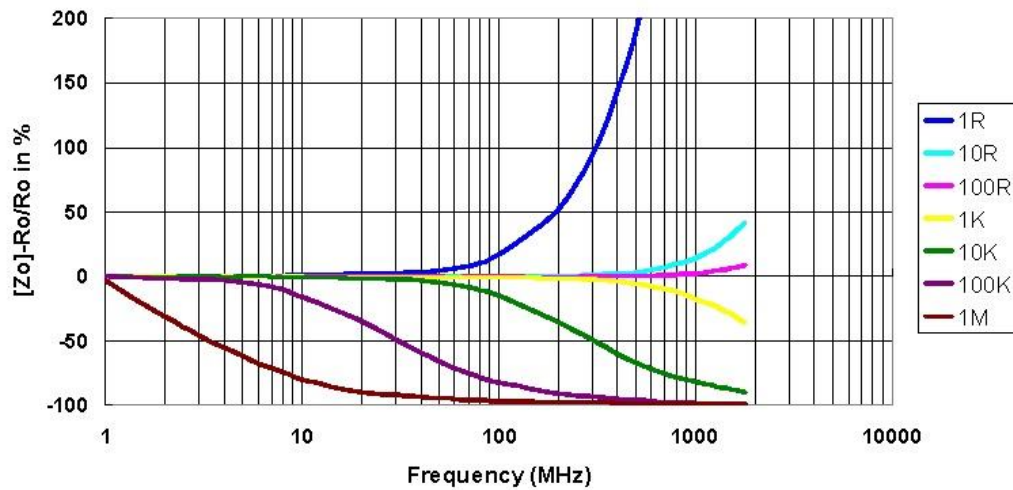

Frequency Vs Phase Angle

SMA-A0204

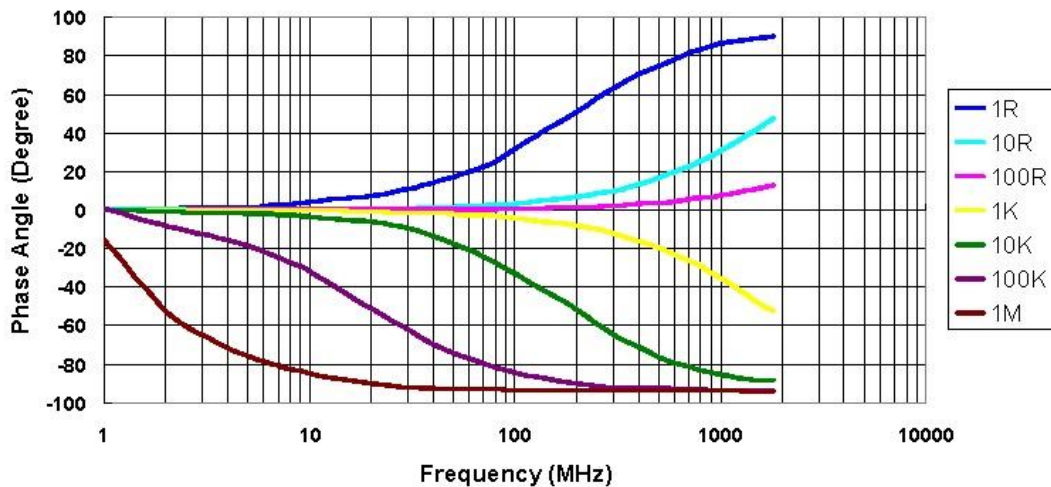

Frequency Vs Impedance

SMA-A0207

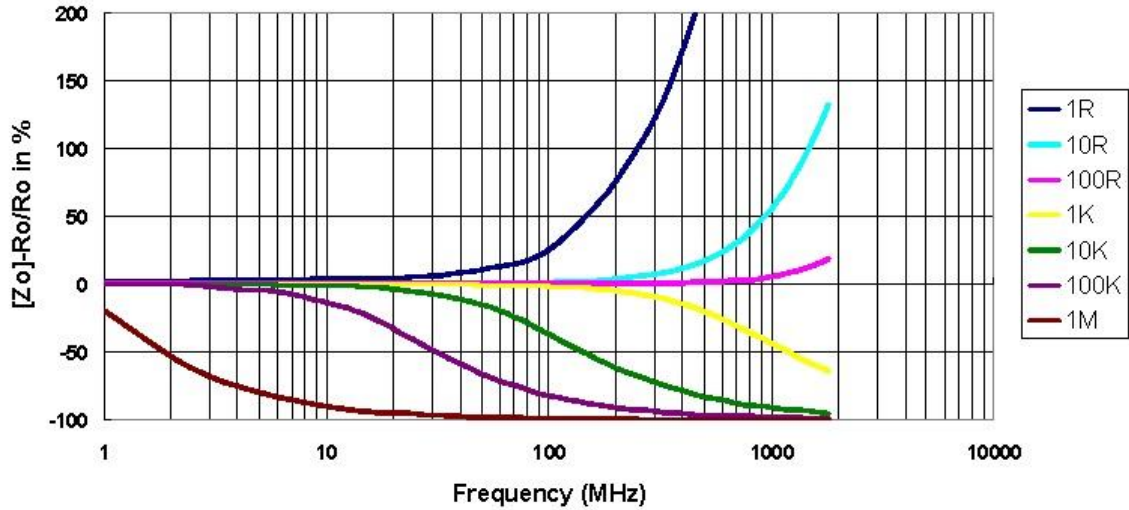

Frequency Vs Phase Angle

SMA-A0207

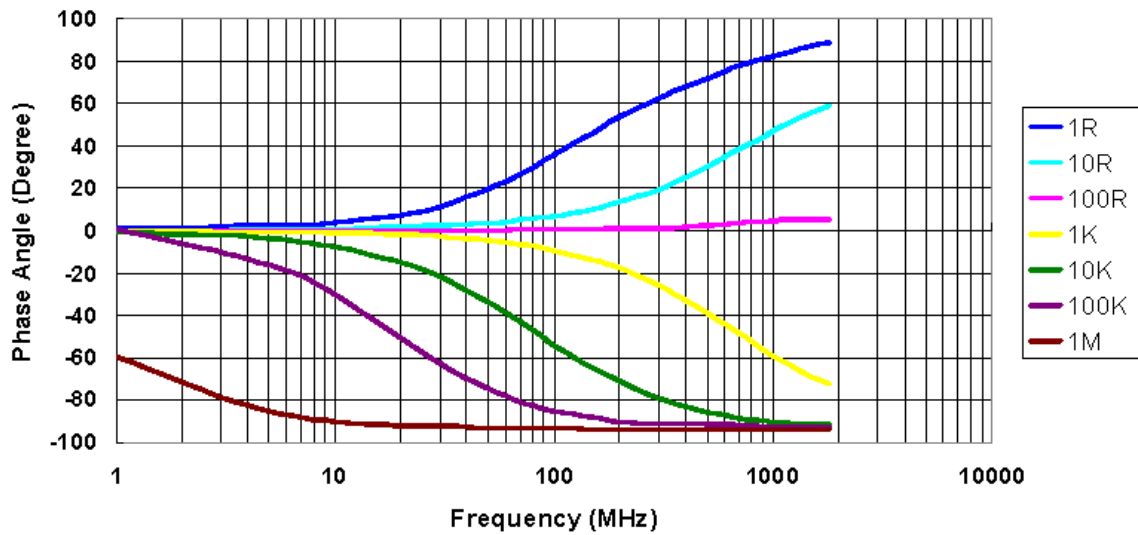

Lightning Surge

Resistors are tested in accordance with IEC 60115-1 using both 1.2/50us and 10/700us pulse shapes. The limit of acceptance is a shift in resistance of less than 0.5% from the initial value.

1.2/50µs Lightning Surge

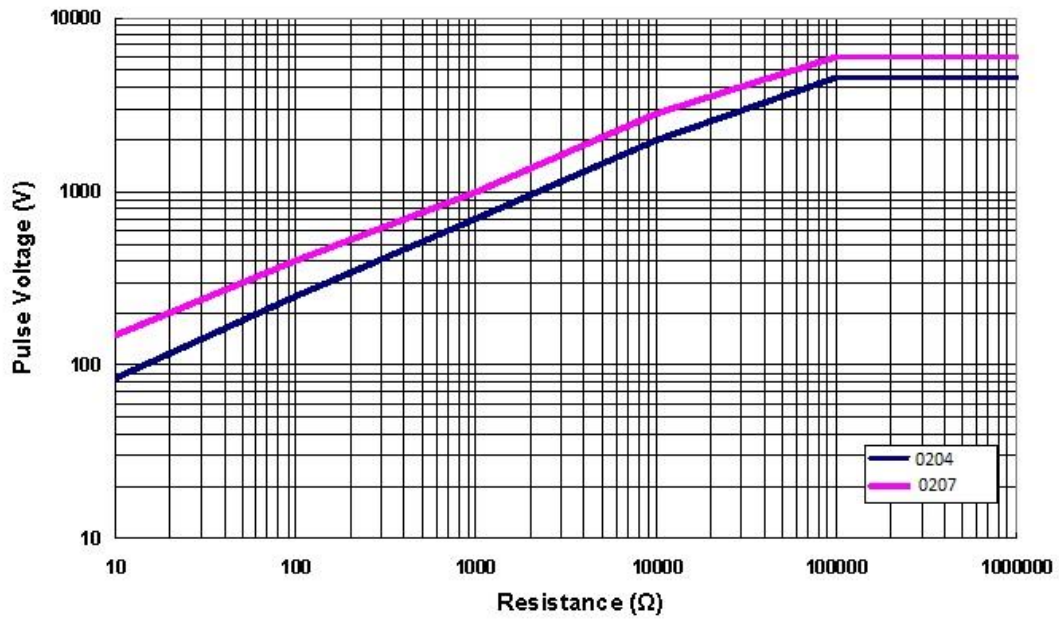

10/700µs Lightning Surge

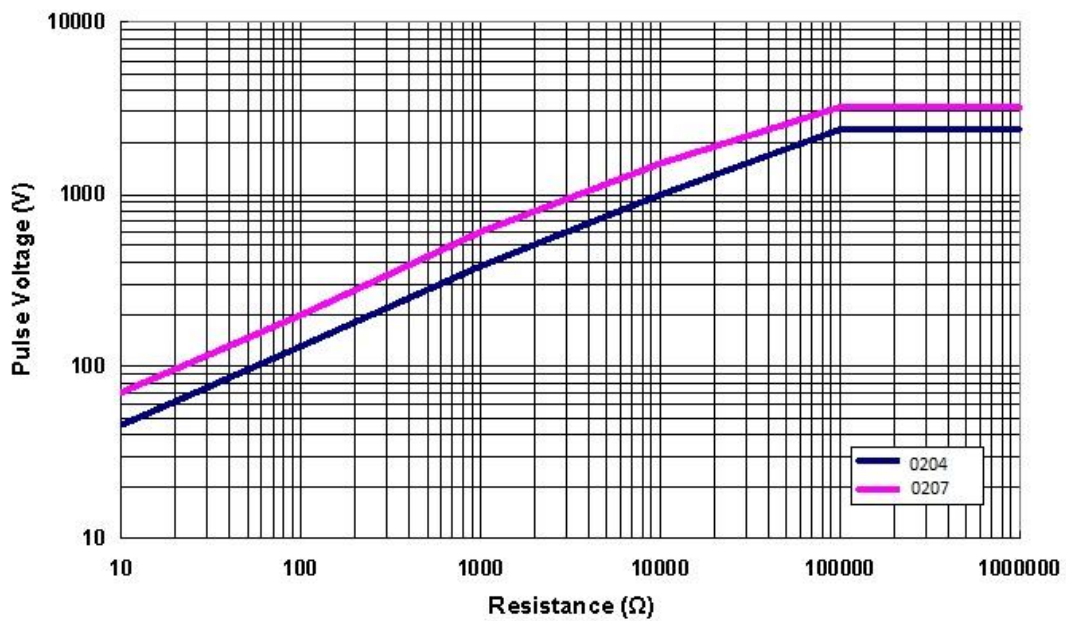

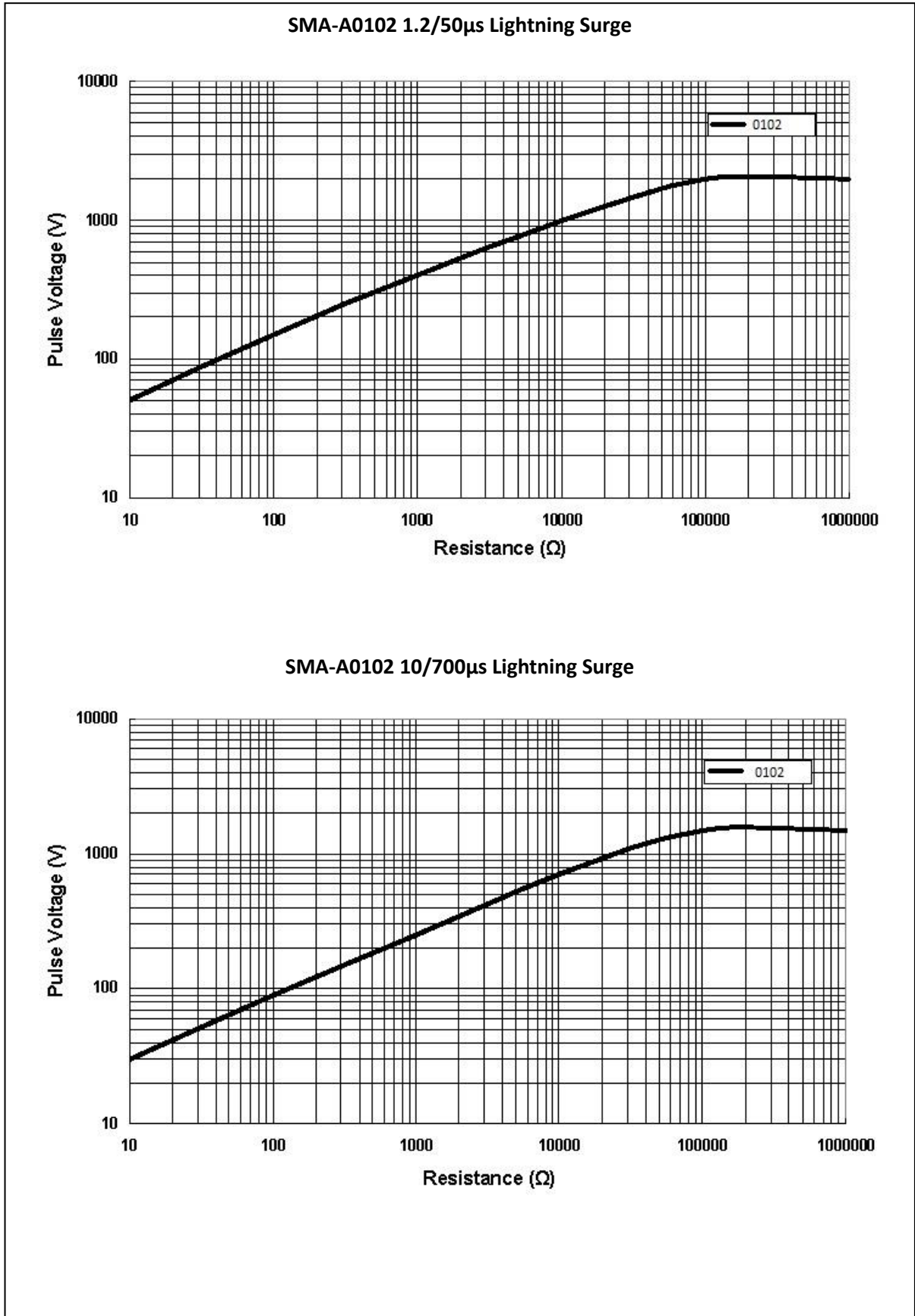

Environmental Characteristics

Item	Requirement	Test Method
Temperature Coefficient of Resistance (T.C.R.)	As Spec	JIS-C-5201-1 4.8 IEC-60115-1 4.8 -55°C~+125°C, 25°C is the reference temperature
Short Time Overload	10Ω-270KΩ: ±(0.1%+0.05Ω) <10Ω & >270KΩ: ±(0.15%+0.05Ω) 0102: ±(0.15%+0.05Ω)	JIS-C-5201-1 4.13 IEC-60115-1 4.13 RCWV*2.5 or Max. Overload Voltage whichever is lower for 5 seconds
Insulation Resistance	≥10G	JIS-C-5201-1 4.6 IEC-60115-1 4.6 Max. Overload Voltage for 1 minute
Endurance	10Ω-270KΩ: ±(0.25%+0.05Ω) <10Ω & >270KΩ: ±(0.5%+0.05Ω) 0102: ±(0.5%+0.05Ω)	JIS-C-5201-1 4.25 IEC-60115-1 4.25.1 MIL-STD-202 Method 108 70±2°C, RCWV for 1000 hrs with 1.5 hrs "ON" and 0.5 hr "OFF"
Biased Humidity	10Ω-270KΩ: ±(0.5%+0.05Ω) <10Ω & >270KΩ: ±(1%+0.05Ω) 0102: ±(2%+0.05Ω)	MIL-STD-202 Method 103 1000 hrs 85°C/85%RH 10% of operating power.
High Temperature Exposure	10Ω-270KΩ: ±(0.25%+0.05Ω) <10Ω & >270KΩ: ±(1%+0.05Ω) 0102: ±(1%+0.05Ω)	MIL-STD-202 Method 108 at +155°C for 1000 hrs
Board Flex	10Ω-270KΩ: ±(0.1%+0.05Ω) <10Ω & >270KΩ: ±(0.5%+0.05Ω) 0102: ±(0.5%+0.05Ω)	AEC-Q200-005 Bending once for 60 seconds with 2mm
Solderability	95% min. coverage	JIS-C-5201-1 4.17 IEC-60115-1 4.17 J-STD-002 245±5°C for 3 seconds
Resistance to Soldering Heat	10Ω-270KΩ: ±(0.1%+0.05Ω) <10Ω & >270KΩ: ±(0.25%+0.05Ω) 0102: ±(0.25%+0.05Ω)	MIL-STD-202 Method 210 260±5°C for 10 seconds
Voltage Proof	No breakdown or flashover	JIS-C-5201-1 4.7 IEC-60115-1 4.7 1.42 times Max. Operating Voltage for 1 minute
Leaching	Individual leaching area ≤5% Total leaching area ≤ 10%	JIS-C-5201-1 4.18 IEC-60068-2-58 8.2.1 260±5°C for 30 seconds
Temperature Cycling	10Ω-270KΩ: ±(0.25%+0.05Ω) <10Ω & >270KΩ: ±(0.5%+0.05Ω) 0102: ±(1%+0.05Ω)	JESD22 Method JA-104 -55°C to +125°C, 1000 cycles
Mechanical Shock	±(0.25%+0.05Ω)	MIL-STD-202 Method 213 Wave Form: Tolerance for half sine shock pulse. Peak value is 100g's. Normal duration (D) is 6.

Environmental Characteristics (continued)

Item	Requirement	Test Method
Vibration	$\pm(0.5\%+0.05\Omega)$	MIL-STD-202 Method 204 5 g's for 20 min., 12 cycles each of 3 orientations, 10-2000 Hz
ESD	$\pm(0.5\%+0.05\Omega)$	AEC-Q200-002 Human body, 2KV
Resistance to Solvents	No visible damage on appearance and marking	MIL-STD-202 Method 215 Add Aqueous wash chemical - OKEM Clean or equivalent. Do not use banned solvents.
Terminal Strength	No broken	AEC-Q200-006 Force of 1.8kg for 60 seconds.
Flammability	No ignition of the tissue paper or scorching of the pinewood board	UL-94 V-0 or V-1 are acceptable. Electrical test not required.
RCWV(Rated Continuous Working Voltage)= $v(P*R)$ or Max. Operating Voltage whichever is lower.		
Storage Temperature: 15~28°C; Humidity < 80%RH		

Packaging

Packaging Quantity and Reel Specification

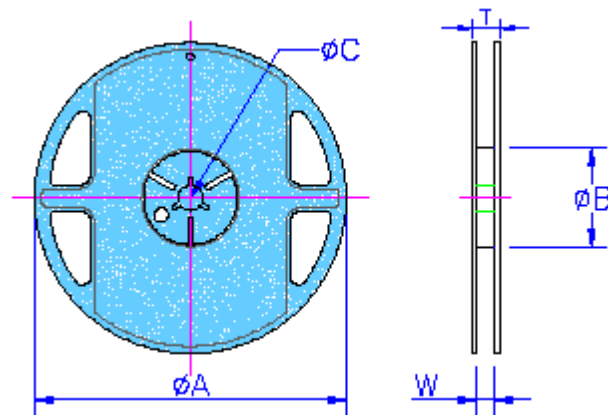

Size	Reel Diameter	ØA (mm)	ØB (mm)	ØC (mm)	W (mm)	T (mm)	Emboss Plastic Tape (EA)
0102	7"	178.5±1.5	60.0±1.0	13.0±0.2	9.0±0.5	12.5±0.5	3,000
0204	7"	178.5±1.5	60.0±1.0	13.0±0.2	9.0±0.5	12.5±0.5	3,000
0207	7"	178.5±1.5	60.0±1.0	13.0±0.2	13.0±0.5	15.5±0.5	2,000

Embossed Plastic Tape Specification

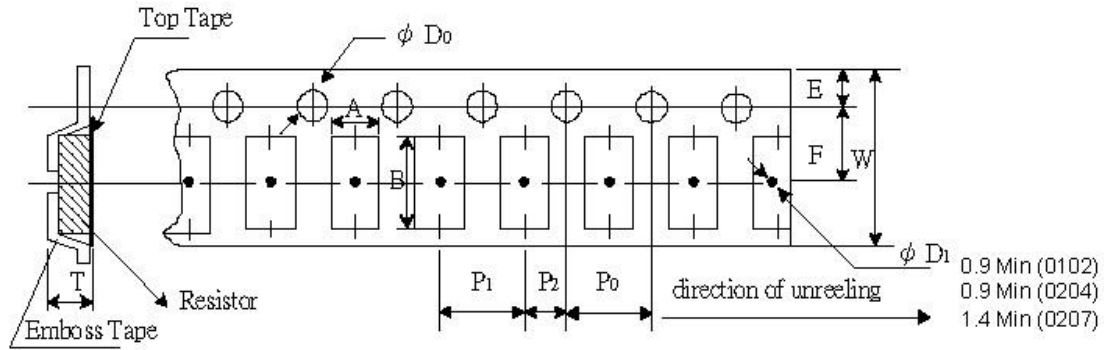

Size	A (mm) ±0.10	B (mm) ±0.10	W (mm) ±0.10	E (mm) ±0.10	F (mm) ±0.05	P0 (mm) ±0.10	P1 (mm) ±0.10	P2 (mm) ±0.05	ΦD0 (mm) ±0.10	T (mm) ±0.10
0102	1.30	2.40	8.0	1.75	3.50	4.00	4.00	2.00	1.50	1.50
0204	1.55	3.65	8.0	1.75	3.50	4.00	4.00	2.00	1.50	1.80
0207	2.40	6.15	12.0	1.75	5.50	4.00	4.00	2.00	1.50	2.70

Marking

E-24

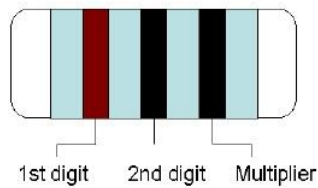

E-96

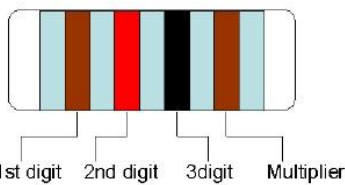

Color	Digit	Multiplier
Silver	-	10 ⁻²
Gold	-	10 ⁻¹
Black	0	10 ⁰
Brown	1	10 ¹
Red	2	10 ²
Orange	3	10 ³
Yellow	4	10 ⁴
Green	5	10 ⁵
Blue	6	10 ⁶
Violet	7	10 ⁷
Grey	8	10 ⁸
White	9	10 ⁹

How To Order

SMA-A	0204	B	T	N	X	100R
Common Part	Size	Tolerance	Packaging	TCR	Power Rating	Resistance Codes
SMA-A MELF Resistor AEC-Q200 compliant	0102 0204 0207	B - 0.1% C - 0.25% D - 0.5% F - 1% J - 5%	T - Tape and Reel	B - ±10PPM/°C N - ±15PPM/°C C - ±25PPM/°C D - ±50PPM/°C E - ±100PPM/°C	T - 1W U - 0.5W X - 0.4W L - 0.3W V - 0.25W P - 0.2W	10R - 10Ω 100R - 100Ω 1K0 - 1,000Ω 10K - 10,000Ω 100K - 100,000Ω 1M0 - 1,000,000Ω