

Body height of 1.85mm available with long-life of 1 million life cycles.

Multi Control Devices

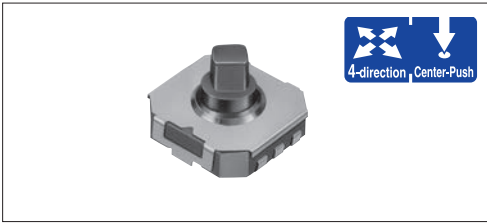

Typical Specifications

Items	Specifications
Rating (max.)	50mA 12V DC
Rating (min.)	10 μ A 1V DC

Product Line

Product No.	Operating force		Travel (mm)		Operating life (5mA 5V DC)	Initial contact resistance	Stem color	Guide bosses	Minimum order unit (pcs.)	
	4-direction	Center push	4-direction	Center push					Japan	Export
SKRHAAE010	1.23N	2.35N	0.25	0.15	200,000 cycles for each direction	500m Ω max.	Black	Without	1,300	1,300
SKRHABE010								With		
SKRHACE010	1.2N	2.35N	0.25	0.15	1,000,000 cycles for each direction	100m Ω max.	Natural	Without		
SKRHADE010								With		

Note

4-directional operating force and travel are measured at 4.3mm height from the bottom of the switch.

Packing Specifications

Taping

Unit:mm

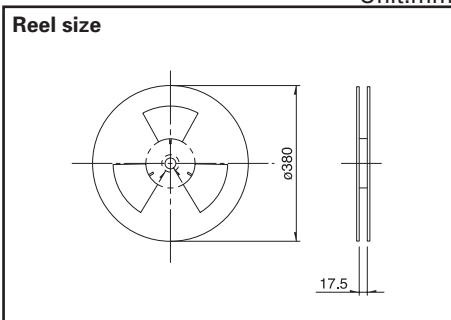

Number of packages (pcs.)			Tape width (mm)	Export package measurements (mm)
1 reel	1 case / Japan	1 case / export packing		
1,300	10,400	10,400	16	401 × 401 × 214

Variable Resistor Type

Switch Type

Dimensions

Unit:mm





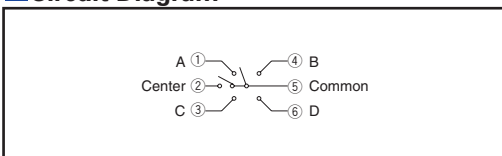







Style	PC board mounting hole and land dimensions (Viewed from mounting face)				
	x	h	a	b	c
SKRHAAE010	7.35	1.8	2.14	1	8.6
SKRHABE010	7.45	1.85	2.17	1.6	8.7

Circuit Diagram



Multi Control Devices

List of Varieties

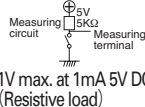
Type		Switch type							
Series		RKJXT1F	RKJXM	RKJXL	RKJXS	SKRV	SKRH		
Photo									
Dimensions (typical value) (mm)	W	17	11 / 19.5	13	11.7	6.45	7.35 / 7.45		
	D					6.4	7.5		
	H	10.5	6.6 / 5.45	6.4	2.3	4	5		
Number of operating shafts		Single-shaft	Single-shaft / Dual-shaft	Single-shaft					
Shaft material		Metal	The inner shaft: Metal The outer shaft: Resin	Metal	Resin				
Directional resolution		4-direction	8-direction			4-direction			
Directional operating feeling (tactile feeling)		With		Without	With				
Lever return mechanism		With							
Center-push switch		With							
Encoder		With	Without / With	Without					
Operating temperature range		-40°C to +85°C		-30°C to +70°C	-20°C to +70°C		-40°C to +85°C		
Operating life	Directional operation	total with 4-direction 50,000 cycles	total with 8-direction 100,000 cycles		500,000 cycles for each direction	200,000 cycles for each direction	200,000 cycles for each direction	1,000,000 cycles for each direction	
	Center-push	50,000 cycles	100,000 cycles		500,000 cycles				
	Encoder	15,000 cycles		—	—	—	—		
Automotive use		●	●	●	—	—	—		
Life cycle (availability)									
Rating (max.) (Resistive load)		10mA 5V DC				50mA 12V DC			
Electrical performance	Output voltage	—	—	—	 1V max. at 1mA 5V DC (Resistive load)	—	—		
	Encoder resolution	15pulses / 360°		—	—	—	—		
	Insulation resistance	100MΩ min. 250V DC			50MΩ min. 50V DC	100MΩ min. 100V DC			
	Voltage proof	300V AC for 1min. or 360V AC for 2s			50V AC for 1min. or 60V AC for 2s	100V AC for 1min.			
Mechanical performance	Directional operating force	40±25mN·m	Direction A, B, C, D 30±20mN·m	10±7mN·m	0.8±0.5N	1.2±0.6N	1.23±0.69N	1.2±0.69N	
		Direction AB, BC, CD, DA 25±20mN·m							
	Push operating force	5±2N	3±1.5N	4.5±1N	2.5±1.5N	2.4±0.69N	2.35±0.69N		
	Encoder detent torque	15±8mN·m	12±8mN·m	—	—	—	—		
	Terminal strength	5N for 1min.	—	—	—	—	—		
Actuator strength	Push / pull directions	100N (Push / Pull)	100N (Push), 50N (Pull)		30N (Push), 10N (Pull)	—	—		
	Operating direction	0.4N·m	0.3N·m	100N	20N	29.4N			
Environmental performance	Cold	-40±2°C for 500h			-40±2°C for 96h	-30±2°C for 96h	-40±2°C for 96h		
	Dry heat	85±2°C for 500h			85±2°C for 96h	80±2°C for 96h	90±2°C for 96h		
	Damp heat	60±2°C, 90 to 95%RH for 500h			60±2°C, 90 to 95%RH for 96h				
Page		415	417	419	420	421	422		

- Switch Type Multi Control Devices Soldering Conditions 429
- Switch Type Multi Control Devices Cautions 430

Note ● indicates applicability to all products in the series.

Switch Type Multi Control Devices / Soldering Conditions

Multi Control Devices

Reference for Hand Soldering

Series	Tip temperature	Soldering time	No. of solders
RKJXT1F, RKJXM, RKJXL, SLLB, SLLB5, SRBE, SKRV, SKRH	350±5°C	3s max.	1 time
RKJXS	350±10°C	3 ⁺¹ ₋₀ s	2 time max.

Reference for Dip Soldering

Series	Preheating		Dip soldering		No. of solders
	Soldering surface temperature	Heating time	Soldering temperature	Soldering time	
RKJXT1F, RKJXM	100°C max.	2 min. max.	260±5°C	5±1s	2 time max.
RKJXL	120°C max.	70s max.	260°C max.	6s max.	2 time max.

Example of Reflow Soldering Condition

1. Heating method: Double heating method with infrared heater.
2. Temperature measurement: Thermocouple 0.1 to 0.2 φ CA (K) or CC (T) at solder joints (copper foil surface).
A heat resistive tape should be used to fix thermocouple.

3. Temperature profile

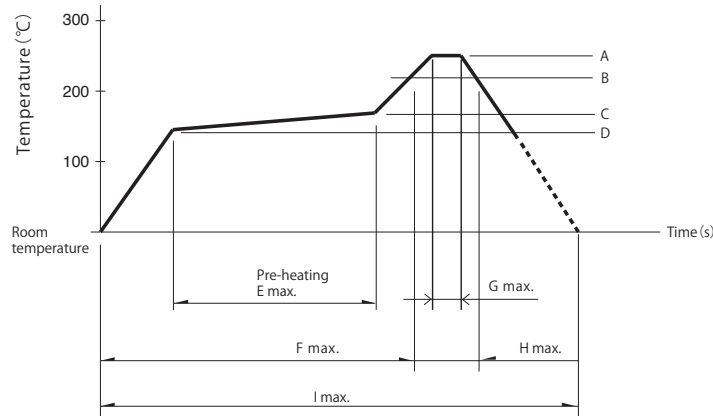

Variable Resistor Type

Switch Type

Series	A	B	C	D	E	F	G	H	I	No. of reflows
RKJXS	260°C	230°C	150°C	150°C	2 min.	—	10s	40s	4 min.	1 time
SLLB5	250°C	230°C	150°C	150°C	—	2 min.	—	30s	—	1 time
SKRV, SKRH, SLLB, SRBE	260°C	230°C	180°C	150°C	2 min.	—	—	40s	—	1 time

Notes

1. The above temperature shall be measured on the mounting surface of a PC board. There are cases where the PC board's temperature greatly differs from that of the switch, depending on the material, size thickness of PC boards and others. The above-stated conditions shall also apply to switch surface temperatures.
2. Soldering conditions differ depending on reflow soldering machines. Prior verification of soldering condition is highly recommended.