

# General Specifications

Toggles

Rockers

Pushbuttons

Illuminated PB

Programmable

Keylocks

Rotaries

Slides

Tactiles

Tilt

Touch

Indicators

Accessories

Supplement

## Electrical Capacity (Resistive Load)

**Logic Level:** 0.4VA maximum @ 28V AC/DC maximum  
(Applicable Range 0.1mA ~ 0.1A @ 20mV ~ 28V)  
See Supplement section to find explanation of operating range

## Other Ratings

**Contact Resistance:** 80 milliohms maximum  
**Insulation Resistance:** 100 megohms minimum @ 500V DC  
**Dielectric Strength:** 500V AC minimum for 1 minute minimum  
**Mechanical Life:** 30,000 cycles minimum  
**Electrical Life:** 10,000 cycles minimum  
**Nominal Operating Torque:** .026Nm (.234 lb•in) for momentary action models  
 .020Nm (.182 lb•in) for maintained action models  
**Contact Timing:** Break-before-make  
**Angle of Throw:** 90° for 2-position & 45° for 3-position

## Materials & Finishes

**Boot:** Polyvinyl chloride  
**Key:** Brass alloy with bright nickel plating;  
 brass alloy with bright nickel plating & ABS resin handle  
**Tumbler Barrel:** Polyacetal  
**Bushing:** Zinc alloy with nickel plating  
**Bracket:** Steel with tin plating  
**Base:** Glass fiber reinforced polyamide  
**Movable Contactor:** Beryllium copper with gold plating  
**Stationary Contacts:** Copper with gold plating  
**Terminals:** Brass with tin plating

## Environmental Data

**Operating Temperature Range:** -25°C through +70°C (-13°F through +158°F)  
**Humidity:** 90 ~ 95% humidity for 240 hours @ 40°C (104°F)  
**Vibration:** 10 ~ 55Hz with peak-to-peak amplitude of 1.5mm traversing the frequency range & returning in 1 minute; 3 right angled directions for 2 hours  
**Shock:** 50G (490m/s<sup>2</sup>) acceleration (tested in 6 right angled directions, with 5 shocks in each direction)

## PCB Processing

**Soldering:** Wave Soldering recommended: See Profile B in Supplement section.  
 Manual Soldering: See Profile B in Supplement section.  
**Cleaning:** Automated cleaning. Boot must be on switch during processing.  
 See Cleaning specifications in Supplement section.

## Standards & Certifications

These SK Series devices have not been tested for UL recognition or CSA certification. These switches are designed for use in a low-voltage, low-current, logic-level circuit. When used as intended in a logic-level circuit, the results do not produce hazardous energy.

# Distinctive Characteristics

Sealed body construction plus disposable boot protect contacts and allow automated processing.

Molded-in terminals seal out flux, solvents, and other contaminants.

Short body size for space-saving, behind panel dimensions.

Detent mechanism, with its spring-operated steel ball, gives crisp, positive action for accurate switch setting.

Bifurcated, self-wiping contact mechanism provides unequalled logic-level reliability and smoother, positive detent actuation.

Crimped bracket legs ensure secure PCB mounting and prevent dislodging during automated wave soldering.

.100" x .100" (2.54mm x 2.54mm) terminal spacing conforms to standard PC board grid spacing.

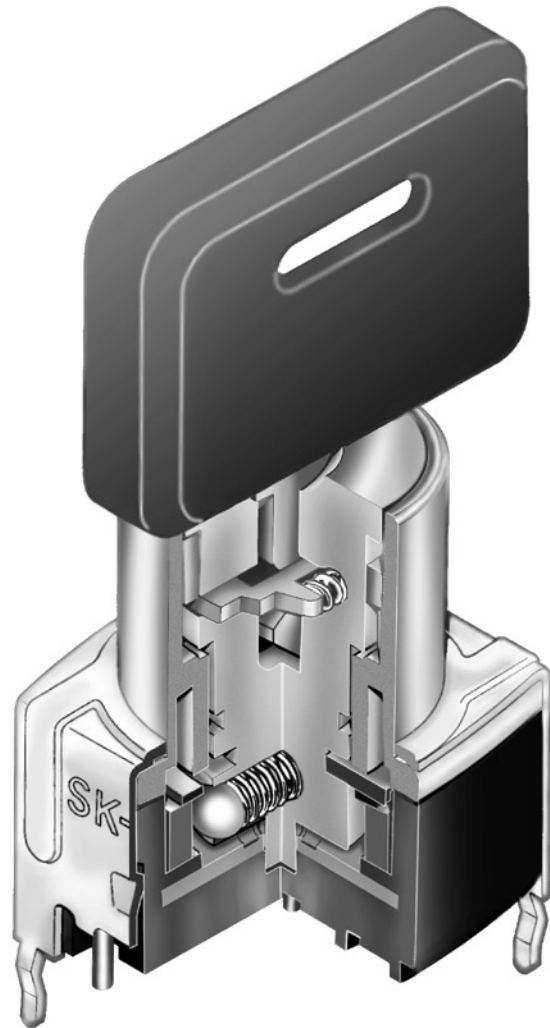

Actual Size

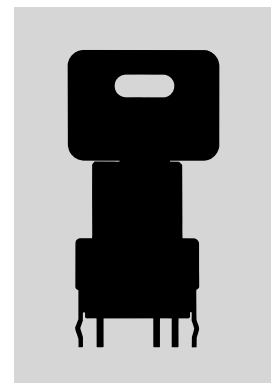

Toggles

Rockers

Pushbuttons

Illuminated PB

Programmable

**F** Keylocks

Rotaries

Slides

Tactiles

Tilt

Touch

Indicators

Accessories

Supplement

### TYPICAL SWITCH ORDERING EXAMPLE



### DESCRIPTION FOR TYPICAL ORDERING EXAMPLE

#### SK24EG30



Toggles  
Rocker  
Pushbuttons  
Illuminated PB  
Programmable  
Keylocks  
Rotaries  
Slides  
Tactiles  
Tilt  
Touch  
Indicators  
Accessories  
Supplement

## POLES, CIRCUITS & KEY-REMOVABLE POSITIONS

Pole & Throw	Model	Key Positions			Connected Terminals (Terminal numbers are not on switch)			Schematic	⊙ = Key Removable ● = Not Removable ✓ = Maximum Arc
		Pos 1	Pos 2	Pos 3	Pos 1	Pos 2	Pos 3		
SPDT	SK12A	ON	NONE	ON	C1-1	—	C1-2		
SPDT SPDT	SK12B SK15B	ON ON	NONE NONE	ON (ON)	C1-1	—	C1-2		
DPDT	SK22A	ON	NONE	ON	C1-1 C2-4	—	C1-2 C2-5		
DPDT DPDT	SK22B SK25B	ON ON	NONE NONE	ON (ON)	C1-1 C2-4	—	C1-2 C2-5		
SP3T	SK14D	ON	ON	ON	C1-1	C1-2	C1-3		
SP3T	SK14E	ON	ON	ON	C1-1	C1-2	C1-3		
DP3T	SK24D	ON	ON	ON	C1-1 C2-4	C1-2 C2-5	C1-3 C2-6		
DP3T	SK24E	ON	ON	ON	C1-1 C2-4	C1-2 C2-5	C1-3 C2-6		

## KEY REMOVABLE

**A** Positions 1 & 3  
90° Angular Throw

**B** Position 1  
90° Angular Throw

**D** Positions 1, 2 & 3  
45° Angular Throw

**E** Position 2  
45° Angular Throw

## CONTACT MATERIAL & RATING

**G** Gold over Copper

Logic Level

0.4VA maximum @ 28V AC/DC maximum

## TERMINALS

**13** Straight PC Terminals with Bracket

**30** Right Angle PC Terminals

Double Throw Model

Three Throw Model

Double Throw Model

Three Throw Model

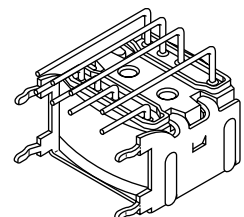
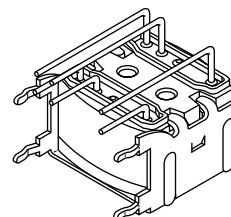
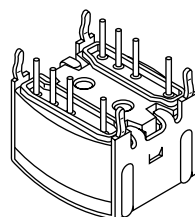
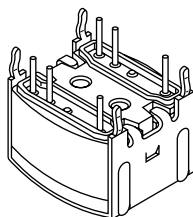

Toggles  
 Rockers  
 Pushbuttons  
 Illuminated PB  
 Programmable  
**F** Keylocks  
 Rotaries  
 Slides  
 Tactiles  
 Tilt  
 Touch  
 Indicators  
 Accessories  
 Supplement

### KEYS

#### AT4080 Standard Antistatic Plastic Handle

Brass Alloy with Bright Nickel Plating & ABS Resin Handle

2 keys supplied with each switch

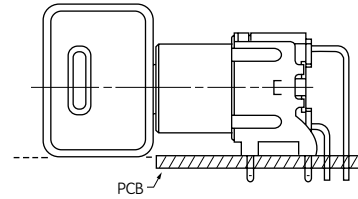
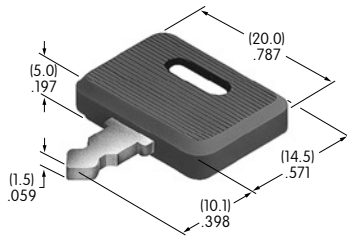

Suitable for all Straight PCB mount and for Right Angle PCB mount where clearance for key is obtainable.

#### AT4079 for Right Angle Mid-board Mounting (Optional) All Metal

Brass Alloy with Bright Nickel Plating

Contact factory if metal keys needed

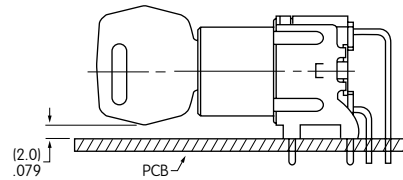
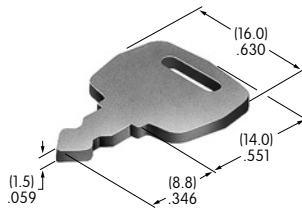

### TYPICAL SWITCH DIMENSIONS

#### Straight PC with Bracket • Double Throw

#### Single & Double Pole

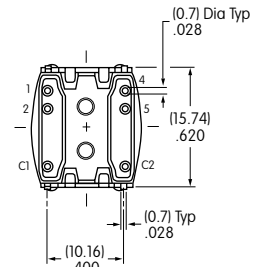
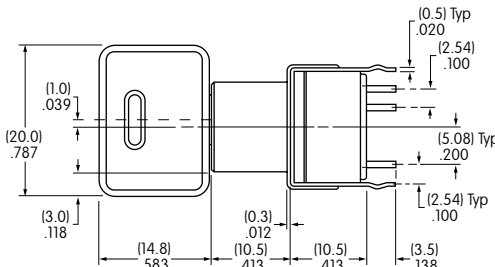
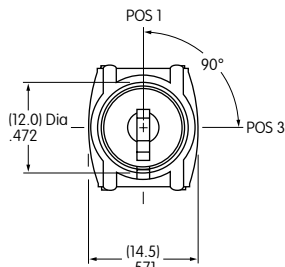

SK12AG13

Single Pole models have only terminals 1, 2 & C1

#### Straight PC with Bracket • Three Throw

#### Single & Double Pole

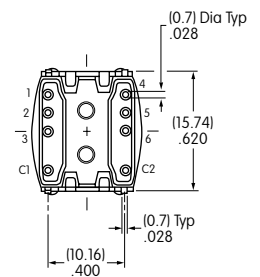
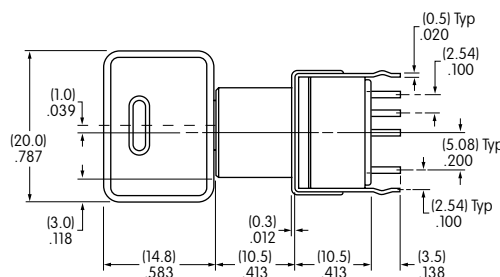
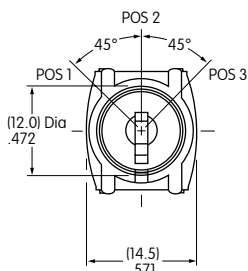

SK24DG13

Single Pole models have only terminals 1, 2, 3 & C1

## TYPICAL SWITCH DIMENSIONS

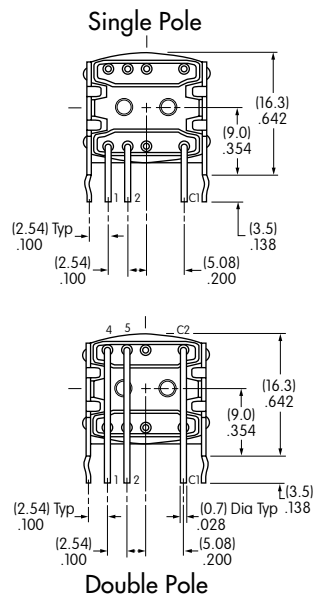
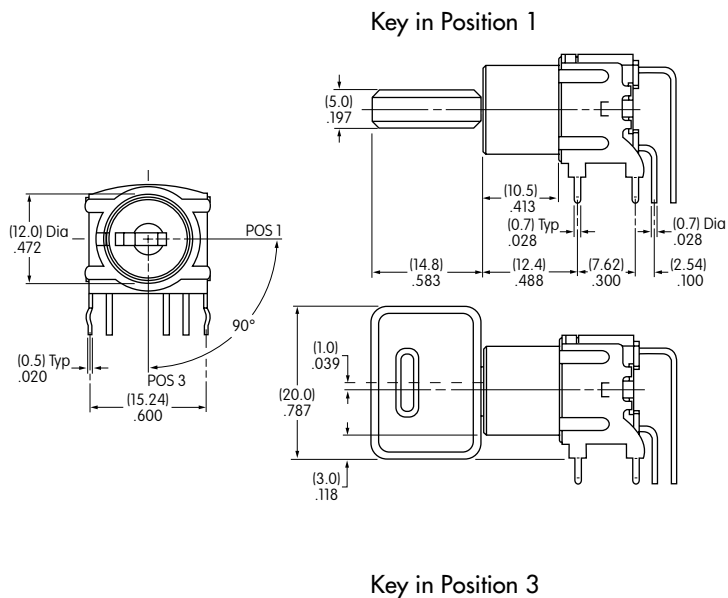

**Right Angle  
PC Terminals  
Double Throw**



**SK15BG30**

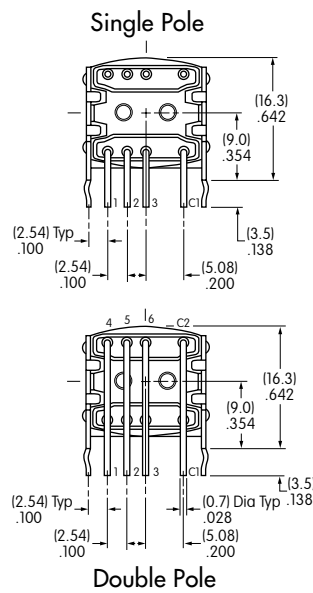
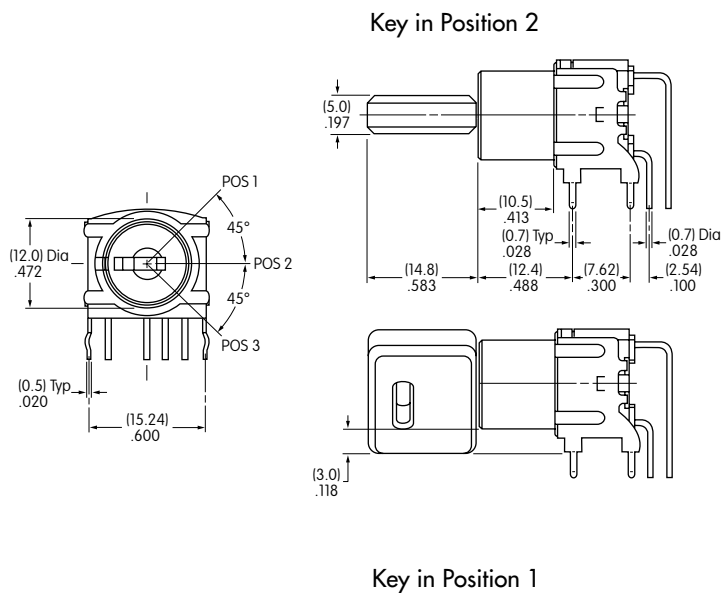

**Right Angle  
PC Terminals  
Three Throw**



**SK24EG30**

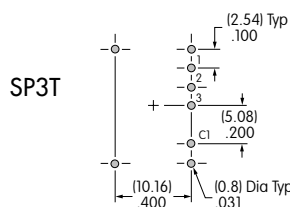
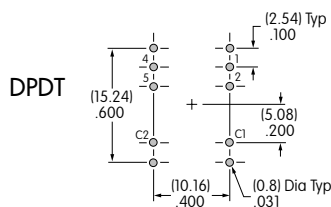
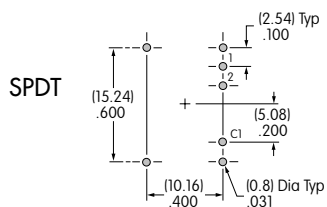

### Straight PC Footprints

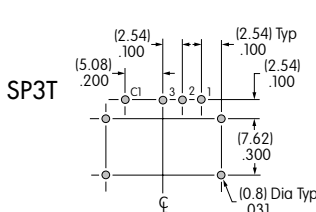
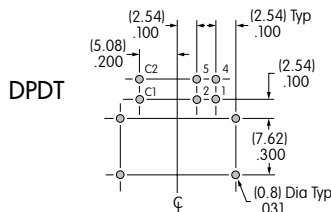
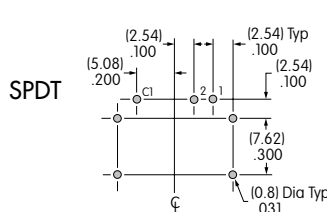
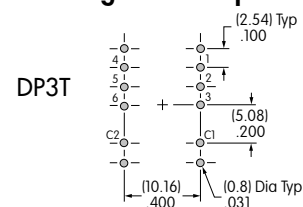

### Right Angle PC Footprints

