

PRECISION STRAIN GAGE

PRECISION LINEAR PATTERN FOR STATIC AND DYNAMIC APPLICATIONS



SGD Series







- ✓ Very Flexible, Mechanically Strong
- ✓ Small Bending Radius
- ✓ Broad Temperature Range
- ✓ Ribbon Leads or Solder Pads
- ✓ Clear Alignment Marks
- ✓ Affix with Cold or Hot Curing Adhesives

OMEGA® strain gages are available in a variety of models to cover most strain measurement applications. Their rugged construction and flexibility make them suitable for highly accurate static and dynamic measurement. The measuring grid is formed by etching constantan foil, which is then completely sealed in a carrier medium composed of polyimide film. The linear pattern strain gages are used to measure strain in a single direction. They are often used for experimental stress analysis applications. The strain gage pattern is shown on the left side of the table. Notice the "arrow" which indicates the principal stress direction.

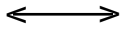
The linear pattern strain gages are available in a variety of styles and sizes. OMEGA is offering miniature linear patterns for strain measurement of a stress concentration or high gradient areas. We also have wide or narrow grid patterns, and small, medium or large patterns. To determine if the strain gages have temperature characteristics matched to steel or aluminum, see the column labeled "COMP" short for compensation, "ST" indicates steel, "AL" indicates aluminum, "UNC" indicates uncompensated. See the column labeled "BTP" for accessory bondable terminal pad model numbers.

Dimensions are listed for pattern gage grid length (A) and width (B), and the matrix or carrier length (C) and width (D). The patterns include alignment triangles. The carrier or matrix material on the patterns may be trimmed in the field on all sides to within 0.25 mm of the foil grid with no effect on strain gage performance.

To Order

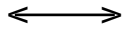
GAGE PATTERN Leads not shown	MODEL NO. Pkg of 10	NOM. RESIS- TANCE (Ω)	DIMENSIONS mm (inch)†				MAX V* (Vrms)	TERMINATION	TEMP COMP	TERM PAD
			GRID		CARRIER					
			A	B	C	D				
 Shown actual size 4.70 mm 	SGD-1.5/120-LY11	120	1.50 (0.059)	1.20 (0.047)	4.70 (0.185)	3.40 (0.134)	2.5	Ribbon Leads	ST	BTP-1
	SGD-1.5/120-LY13	120	Miniature linear pattern Measurement of stress concentration 120 Ω				3.5	Ribbon Leads	AL	
	SGD-1.5/120-LY41	120					2.5	Solder Pads	ST	
	SGD-1.5/120-LY43	120					3.5	Solder Pads	AL	
 Shown actual size 7.60 mm 	SGD-2/350-LY11	350	2.00 (0.079)	2.50 (0.098)	7.60 (0.299)	5.80 (0.228)	7.5	Ribbon Leads	ST	BTP-1
	SGD-2/350-LY13	350	Miniature linear pattern Measurement of stress concentration, higher resistance reduced heat generation 350 Ω				10	Ribbon Leads	AL	
	SGD-2/350-LY41	350					7.5	Solder Pads	ST	
	SGD-2/350-LY43	350					10	Solder Pads	AL	
 Shown actual size 7.10 mm 	SGD-2D/350-LY11	350	1.90 (0.075)	4.80 (0.189)	7.10 (0.280)	6.60 (0.260)	10	Ribbon Leads	ST	BTP-2
	SGD-2D/350-LY13	350	Miniature linear pattern grid width, wide 350 Ω				14	Ribbon Leads	AL	
	SGD-2D/350-LY41	350					10	Solder Pads	ST	
	SGD-2D/350-LY43	350					14	Solder Pads	AL	
 Shown actual size 7.00 mm 	SGD-3/350-LY11	350	3.20 (0.126)	2.50 (0.098)	7.00 (0.276)	4.00 (0.157)	9.5	Ribbon Leads	ST	BTP-3
	SGD-3/350-LY13	350	linear pattern leads/ pads at on end of grid 350 Ω				13	Ribbon Leads	AL	
	SGD-3/350-LY41	350					9.5	Solder Pads	ST	
	SGD-3/350-LY43	350					13	Solder Pads	AL	



STRAIN GAGES

DISCOUNT SCHEDULE	
1 to 10 pkgs.	Net
11 to 24 pkgs.5%
25 to 49 pkgs.	10%
50 and up and OEM . . .	Consult Factory

† For dimensions key, visit us online.
 * Maximum permitted bridge energizing voltage (Vrms).
 Note: For strain gage accessories visit us online.
 Ordering Example: SGD-3/350-LY11, 3.2 mm grid, 350 Ω nominal-resistance strain gage.



NOTE
 ST = Steel
 AL = Aluminum

PRECISION STRAIN GAGE

PRECISION LINEAR PATTERN FOR STATIC AND DYNAMIC APPLICATIONS



To Order										
GAGE PATTERN Leads not shown	MODEL NO. Pkg of 10	NOM. RESIS- TANCE (Ω)	DIMENSIONS mm (inch) [†]				MAX V* (Vrms)	TERMINATION	TEMP COMP	TERM PAD
			GRID		CARRIER					
			A	B	C	D				
Shown actual size 7.80 mm ← →	SGD-3/120-LY11	120	3.00 1.50 7.80 3.80 (0.118) (0.059) (0.307) (0.150) Linear pattern, grid width narrow 120 Ω	4	Ribbon Leads	ST	BTP-3			
	SGD-3/120-LY13	120								
	SGD-3/120-LY41	120								
	SGD-1.5/120-LY43	120								
Shown actual size 6.60 mm ← →	SGD-3S/120-LY11	120	3.00 1.70 6.60 3.30 (0.118) (0.067) (0.260) (0.130) Linear pattern, small size 120 Ω	4.5	Ribbon Leads	ST	BTP-3			
	SGD-3S/120-LY13	120								
	SGD-3S/120-LY41	120								
	SGD-3S/120-LY43	120								
Shown actual size 7.90 mm ← →	SGD-4/120-LY11	120	3.80 5.70 7.90 7.10 (0.150) (0.224) (0.311) (0.280) Linear pattern, grid width wide 120 Ω	9	Ribbon Leads	ST	BTP-3			
	SGD-4/120-LY13	120								
	SGD-4/120-LY41	120								
	SGD-4/120-LY43	120								
Shown actual size 9.80 mm ← →	SGD-5/350-LY11	350	4.50 3.20 9.80 5.20 (0.177) (0.126) (0.386) (0.205) Linear pattern, medium size 350 Ω	12	Ribbon Leads	ST	BTP-4			
	SGD-5/350-LY13	350								
	SGD-5/350-LY41	350								
	SGD-5/350-LY43	350								

DISCOUNT SCHEDULE	
1 to 10 pkgs.	Net
11 to 24 pkgs.	5%
25 to 49 pkgs.	10%
50 and up and OEM . . .	Consult Factory

* Maximum permitted bridge energizing voltage (Vrms).
Note: For strain gage accessories visit us online.
Ordering Example: SGD-4/120-LY13, 3.8 mm grid, 120 Ω nominal-resistance strain gage.

NOTE
 ST = Steel
 AL = Aluminum

**Custom-Designed
 Strain Gages
 Available!**
 No Minimum Quantities.
 Consult Engineering.

TYPICAL STRAIN GAGE INSTALLATION

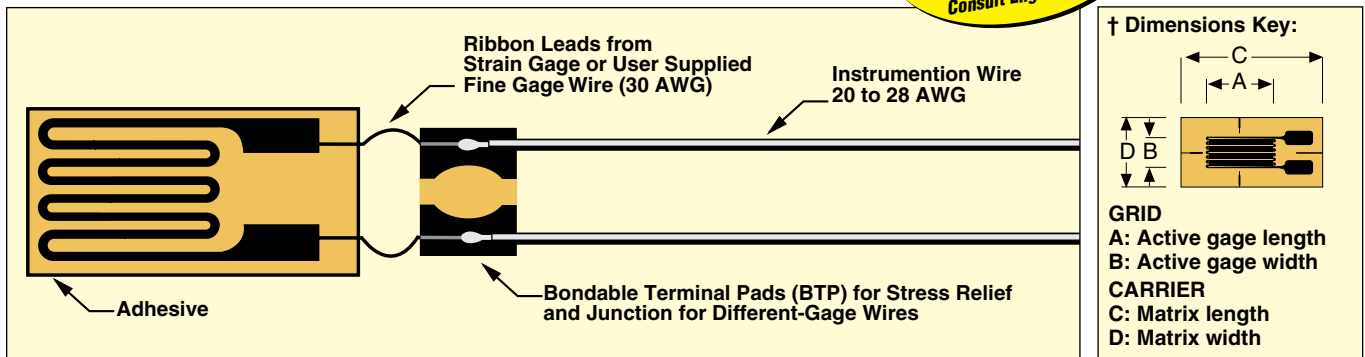

PRECISION STRAIN GAGE

PRECISION LINEAR PATTERN FOR STATIC AND DYNAMIC APPLICATIONS



To Order													
GAGE PATTERN Leads not shown	MODEL NO. Pkg of 10	NOM. RESIS- TANCE (Ω)	DIMENSIONS mm (inch) [†]				MAX V* (Vrms)	TERMINATION	TEMP COMP	TERM PAD			
			GRID		CARRIER								
			A	B	C	D							
Shown actual size 11.4 mm 	SGD-6/120-LY11	120	6.50 3.10 11.40 5.10 (0.256) (0.122) (0.449) (0.201) Linear pattern, medium size 120 Ω	9	Ribbon Leads	ST	BTP-4						
	SGD-6/120-LY13	120						12	Ribbon Leads	AL			
	SGD-6/120-LY41	120									9	Solder Pads	ST
	SGD-6/120-LY43	120											
Shown actual size 11.4 mm 	SGD-7/350-LY11	350	6.50 3.10 11.40 5.10 (0.256) (0.122) (0.449) (0.201) Linear pattern, medium size 350 Ω	15	Ribbon Leads	ST	BTP-5						
	SGD-7/350-LY13	350						20	Ribbon Leads	AL			
	SGD-7/350-LY41	350									15	Solder Pads	ST
	SGD-7/350-LY43	350											
Shown actual size 11.8 mm 	SGD-7/1000-LY11	1000	7.00 3.60 11.80 5.60 (0.276) (0.142) (0.465) (0.220) Medium size, higher resistance, reduced heat generation 1000 Ω	27	Ribbon Leads	ST	BTP-5						
	SGD-7/1000-LY13	1000						37	Ribbon Leads	AL			
	SGD-7/1000-LY41	1000									27	Solder Pads	ST
	SGD-7/1000-LY43	1000											
Shown actual size 17.7 mm 	SGD-10/120-LY11	120	10.00 4.90 17.70 8.00 (0.394) (0.193) (0.697) (0.315) Linear pattern, Large size 120 Ω	14	Ribbon Leads	ST	BTP-5						
	SGD-10/120-LY13	120						19	Ribbon Leads	AL			
	SGD-10/120-LY41	120									14	Solder Pads	ST
	SGD-10/120-LY43	120											

DISCOUNT SCHEDULE

1 to 10 pkgs.	Net
11 to 24 pkgs.5%
25 to 49 pkgs.10%
50 and up and OEM . .	Consult Factory

* Maximum permitted bridge energizing voltage (Vrms).

Note: For strain gage accessories visit us online.

Ordering Example: SGD-6/120-LY13, 6.5 mm grid, 120 Ω nominal-resistance strain gage.

NOTE

ST = Steel
AL = Aluminum

Custom-Designed Strain Gages Available!
No Minimum Quantities. Consult Engineering.

BONDABLE TERMINAL PADS

When installing strain gages with ribbon leads or solder pads, use Bondable Terminal Pads (BTP) between the strain gage and the wires to your instrumentation.

The Bondable Terminal Pads provide a large easy to use soldering area and provide strain relief between the strain gage and the heavy instrument wires.

Using Bondable Terminal Pads is simple. Use the same adhesive and bonding procedure on the Bondable Terminal Pads as you use on the strain gage.

OMEGA offers BTPs in several sizes and wiring configurations to fit most all strain gage applications.

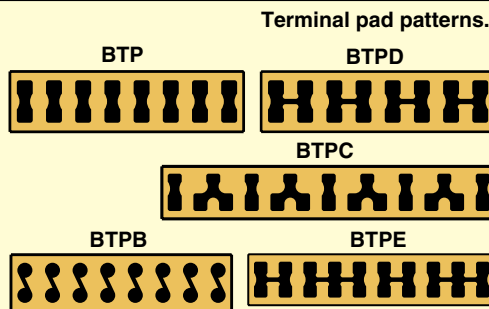

† Dimensions Key:

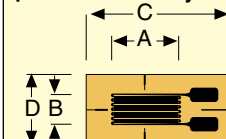

GRID
A: Active gage length
B: Active gage width
CARRIER
C: Matrix length
D: Matrix width

STRAIN GAGES E

PRECISION STRAIN GAGE

PRECISION LINEAR PATTERN AND EXTRA LONG PATTERN



To Order

GAGE PATTERN Leads not shown	MODEL NO. Pkg of 10	NOM. RESIS- TANCE (Ω)	DIMENSIONS mm (inch) [†]				MAX V* (Vrms)	TERMINATION	TEMP COMP	TERM PAD
			GRID		CARRIER					
			A	B	C	D				
Shown actual size 17.7 mm 	SGD-10/350-LY11	350	10.00 (0.394)	4.90 (0.193)	17.70 (0.697)	8.00 (0.315)	22	Ribbon Leads	ST	BTP-5
	SGD-10/350-LY13	350					32	Ribbon Leads	AL	
	SGD-10/350-LY41	350					22	Solder Pads	ST	
	SGD-10/350-LY43	350					32	Solder Pads	AL	
Shown actual size 17.7 mm 	SGD-10/1000-LY11	1000	10.00 (0.394)	4.90 (0.193)	17.70 (0.697)	8.00 (0.315)	40	Ribbon Leads	ST	BTP-5
	SGD-10/1000-LY13	1000					55	Ribbon Leads	AL	
	SGD-10/1000-LY41	1000					40	Solder Pads	ST	
	SGD-10/1000-LY43	1000					55	Solder Pads	AL	
Shown actual size 22.7 mm 	SGD-13/350-LY11	350	13.00 (0.511)	7.20 (0.283)	22.70 (0.893)	10.00 (0.393)	30	Ribbon Leads	ST	BTP-6
	SGD-13/350-LY13	350					40	Ribbon Leads	AL	
	SGD-13/350-LY41	350					30	Solder Pads	ST	
	SGD-13/350-LY43	350					40	Solder Pads	AL	
Shown actual size 22.7 mm 	SGD-13/1000-LY11	1000	13.00 (0.511)	7.20 (0.283)	22.70 (0.893)	10.00 (0.393)	55	Ribbon Leads	ST	BTP-6
	SGD-13/1000-LY13	1000					75	Ribbon Leads	AL	
	SGD-13/1000-LY41	1000					55	Solder Pads	ST	
	SGD-13/1000-LY43	1000					75	Solder Pads	AL	

DISCOUNT SCHEDULE

1 to 10 pkgs.	Net
11 to 24 pkgs.	5%
25 to 49 pkgs.	10%
50 and up and OEM . .	Consult Factory

[†] For dimensions key, visit us online.

* Maximum permitted bridge energizing voltage (Vrms).

Note: For strain gage accessories, visit us online.

Ordering Example: SGD-13/350-LY13, 13 mm grid, 350 Ω nominal-resistance strain gage.

NOTE

ST = Steel
AL = Aluminum

Extra-Long For Inhomogeneous Material

To Order

GAGE PATTERN Leads not shown	MODEL NO. Pkg of 5	NOM. RESIS- TANCE (Ω)	DIMENSIONS mm (inch) [†]				MAX V* (Vrms)	TERMINATION	TEMP COMP	TERM PAD
			GRID		CARRIER					
			A	B	C	D				
Shown smaller than actual size 50 mm 	SGD-30/120-LY40	120	25.00 (0.984)	8.00 (0.315)	40.00 (1.575)	12.00 (0.472)	12	Solder Pads	UNC	BTP-6
	SGD-30N/120-LY40	120	30.00 (1.181)	3.00 (0.118)	36.00 (1.417)	5.00 (0.197)	10	Solder Pads	UNC	
	SGD-30/350-LY40	350	30.00 (1.181)	3.00 (0.118)	36.00 (1.417)	5.00 (0.197)	14	Solder Pads	UNC	
	SGD-50/120-LY40	120	50.00 (1.969)	4.30 (0.169)	60.00 (2.362)	9.00 (0.354)	12	Solder Pads	UNC	
	SGD-150/240-LY40	240	150.00 (5.906)	5.00 (0.197)	165.00 (6.496)	9.00 (0.354)	35	Solder Pads	UNC	

[†] For dimensions key, visit us online.

* Maximum permitted bridge energizing voltage (Vrms).

Note: For strain gage accessories, visit us online.

Ordering Example: SGD-30/120-LY40, 120 Ω nominal-resistance strain gage.

NOTE

UNC = Uncompensated