

SinglFuse™ SF-1206SxxxM Series Features

- Single blow fuse for overcurrent protection
- 3216 (EIA 1206) miniature footprint
- Slow blow fuse (Fusing time ≤ 5 seconds at 250 % rated current)
- UL 248-14 listed
- Surface mount packaging for automated assembly
- Multilayer SMD design
- RoHS compliant* and halogen free**

SF-1206SxxxM Series - Slow Blow Multilayer Surface Mount Fuses

Electrical Characteristics

Model	Rated Current (Amps)	Fusing Time	Resistance (Ω) Typ.***	Rated Voltage	Resistance (Ω) Typ.***	Typical I^2t (A ² s) ****
SF-1206S050M-2	0.50	Open within 5 sec. at 250 % rated current	0.730	DC 63 V	DC 63 V 50 A	0.002
SF-1206S075M-2	0.75		0.513			0.005
SF-1206S100M-2	1.00		0.220			0.011
SF-1206S150M-2	1.50		0.120			0.024
SF-1206S175M-2	1.75		0.100			0.045
SF-1206S200M-2	2.00		0.050			0.075
SF-1206S250M-2	2.50		0.035	DC 32 V 50 A	0.110	
SF-1206S300M-2	3.00		0.031		0.210	
SF-1206S400M-2	4.00		0.022	DC 32 V	DC 32 V 45 A	0.350
SF-1206S500M-2	5.00		0.015			0.600
SF-1206S600M-2	6.00		0.013			1.000
SF-1206S700M-2	7.00		0.011			1.600
SF-1206S800M-2	8.00		0.008			2.300

*** Resistance value measured with ≤ 10 % rated current at 25 °C ambient.

****Melting I^2t calculated at 0.001 second pre-arcing time.

Reliability Testing

No.	Test	Requirement	Test Condition	Test Reference
1	Soldering heat resistance	DCR change $\leq \pm 10$ % No mechanical damage	One dip at 260 °C for 60 seconds	MIL-STD-202 Method 210
2	Solderability	Minimum 95 % coverage	One dip at 245 °C for 5 seconds	MIL-STD-202 Method 208
3	Thermal shock	DCR change $\leq \pm 10$ % No mechanical damage	100 cycles between -65 °C and +125 °C	MIL-STD-202 Method 107
4	Moisture resistance	DCR change $\leq \pm 15$ % No excessive corrosion	10 cycles	MIL-STD-202 Method 106
5	Salt spray	DCR change $\leq \pm 10$ % No excessive corrosion	48 hour exposure, 5 % salt solution	MIL-STD-202 Method 101
6	Mechanical vibration	DCR change $\leq \pm 10$ % No mechanical damage	0.4 inch D.A. or 30 G between 5-3000 Hz	MIL-STD-202 Method 204
7	Mechanical shock	DCR change $\leq \pm 10$ % No mechanical damage	1500 G, 0.5 ms, half-sine shocks	MIL-STD-202 Method 213
8	Life	No electrical "opens" during testing. Voltage drop change shall be less than ± 20 % of initial value.	80 % rated current (75 % for ≤ 1 A fuses) for 2000 hours at ambient temperature +20 °C ~ +30 °C	Refer to STP document

Environmental Characteristics

Operating Temperature..... -55 °C to +125 °C
 Storage Conditions
 Temperature+5 °C to +35 °C
 Humidity..... 40 % to 75 %
 Shelf Life..... 2 years from manufacturing date
 Moisture Sensitivity Level..... 1
 ESD Classification (HBM)..... Class 6

* RoHS Directive 2002/95/EC Jan. 27, 2003 including annex and RoHS Recast 2011/65/EU June 8, 2011.

** Bourns considers a product to be "halogen free" if (a) the Bromine (Br) content is 900 ppm or less; (b) the Chlorine (Cl) content is 900 ppm or less; and (c) the total Bromine (Br) and Chlorine (Cl) content is 1500 ppm or less.

"SinglFuse" is a trademark of Bourns, Inc.

Specifications are subject to change without notice.

The device characteristics and parameters in this data sheet can and do vary in different applications and actual device performance may vary over time.

Users should verify actual device performance in their specific applications.

Agency Recognition

UL File Number E198545

<http://www.ul.com/> Follow link to Online Certificates Directory, then enter UL File No. E198545, or [click here](#)

BOURNS®

Asia-Pacific: Tel: +886-2 2562-4117 • Email: asiacus@bourns.com

EMEA: Tel: +36 88 520 390 • Email: eurocus@bourns.com

The Americas: Tel: +1-951 781-5500 • Email: americus@bourns.com

www.bourns.com

SinglFuse™ SF-1206SxxxM Series Applications

- Portable memory
- LCD monitors
- Disk drives
- PDAs
- Digital cameras
- MP3 players
- Cell phones
- Rechargeable battery packs
- Battery chargers
- Set-top boxes
- Industrial controllers
- Battery Management Systems (BMS)
- LED lighting
- Power tools

SF-1206SxxxM Series - Slow Blow Multilayer Surface Mount Fuses **BOURNS®**

Typical Part Marking

Represents total content. Layout may vary.



RATED CURRENT (A)

C = 0.50	K = 3.00
D = 0.75	M = 4.00
E = 1.00	N = 5.00
G = 1.50	+ = 6.00
H = 1.75	- = 7.00
I = 2.00	= = 8.00
J = 2.50	

How to Order

SF - 1206 S 100 M - 2

SinglFuse™
 Product Designator
 SMD Footprint
 1206 = 3216 (EIA 1206) size
 Fuse Blow Type
 S = Slow blow
 Rated Current
 050 ~ 800 (0.50 A - 8.00 A)
 Structure Type
 M = Multilayer
 Packaging Type
 - 2 = Tape & Reel

Construction

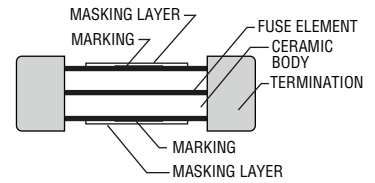

Packaging Quantity

.....3,000 pieces per 7 inch reel

Product Dimensions

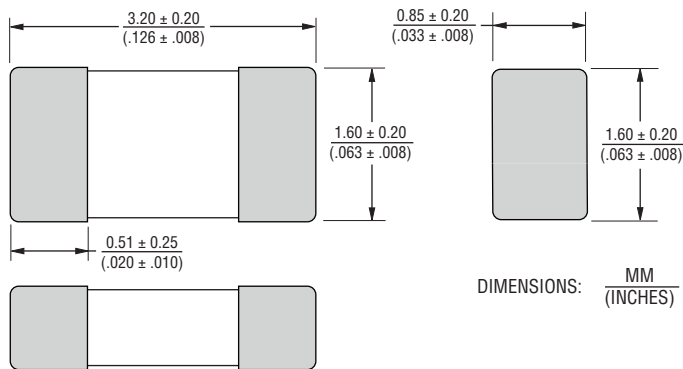

Recommended Pad Layout

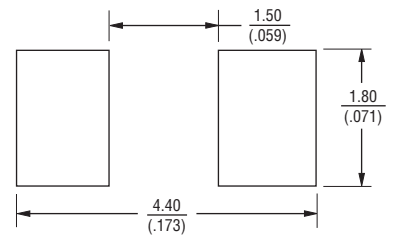

Current Rating Thermal Derating Curve

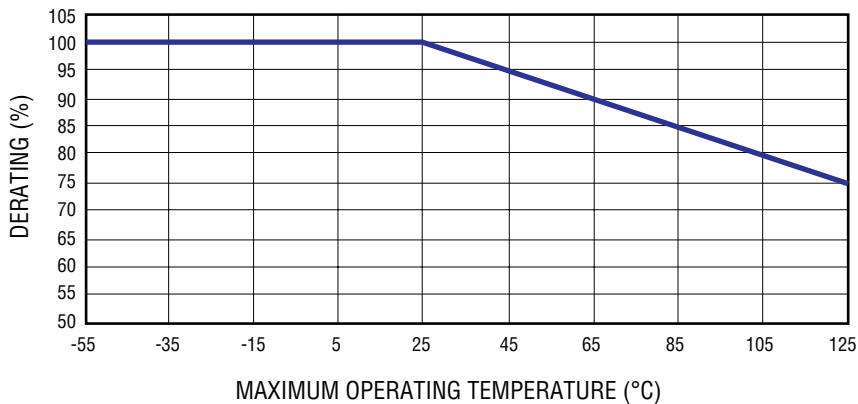

Specifications are subject to change without notice. The device characteristics and parameters in this data sheet can and do vary in different applications and actual device performance may vary over time. Users should verify actual device performance in their specific applications.

Solder Reflow Recommendations

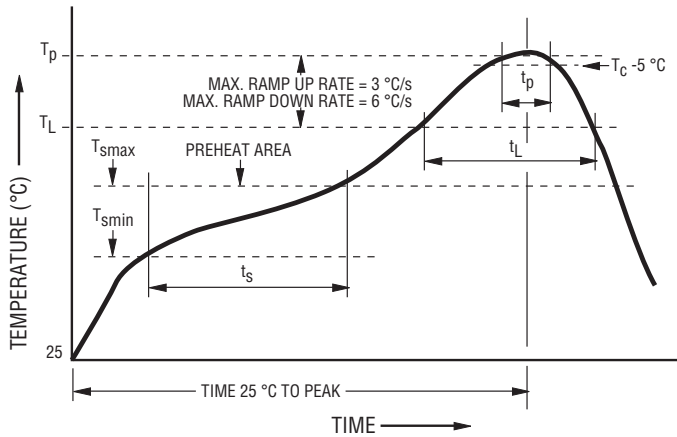

Profile Feature	Pb-Free Assembly
Preheat / Soak: Temperature Min. (T_{smin}) Temperature Max. (T_{smax}) Time (t_s) from (T_{smin} to T_{smax})	150 °C 200 °C 60~120 seconds
Ramp Up Rate (T_L to T_p)	3 °C / second max.
Liquidous Temperature (T_L) Time (t_L) maintained above T_L	217 °C 60~150 seconds
Peak Package Body Temperature (T_p)	260 °C
Time (t_p)* within 5 °C of the specified classification temperature (T_c)	30 seconds*
Ramp Down Rate (T_p to T_L)	6 °C / second max.
Time 25 °C to Peak Temperature	8 minutes max.

*Tolerance for peak profile temperature (T_p) is defined as a supplier minimum and a user maximum.

Recommended Temperature Profile for Wave Soldering

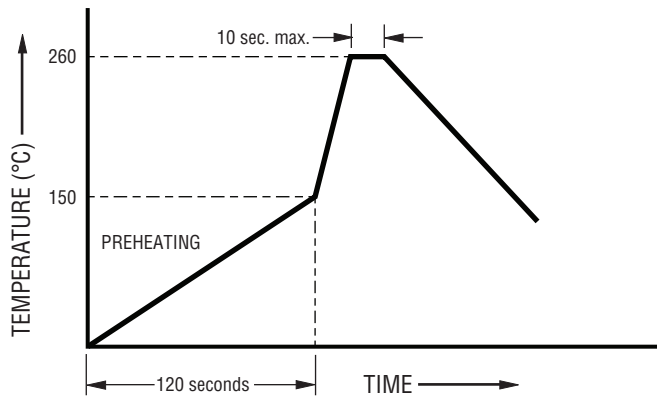

Wave soldering is suitable for 1206 size models.

Average Pre-Arcing Time vs. Current Curves

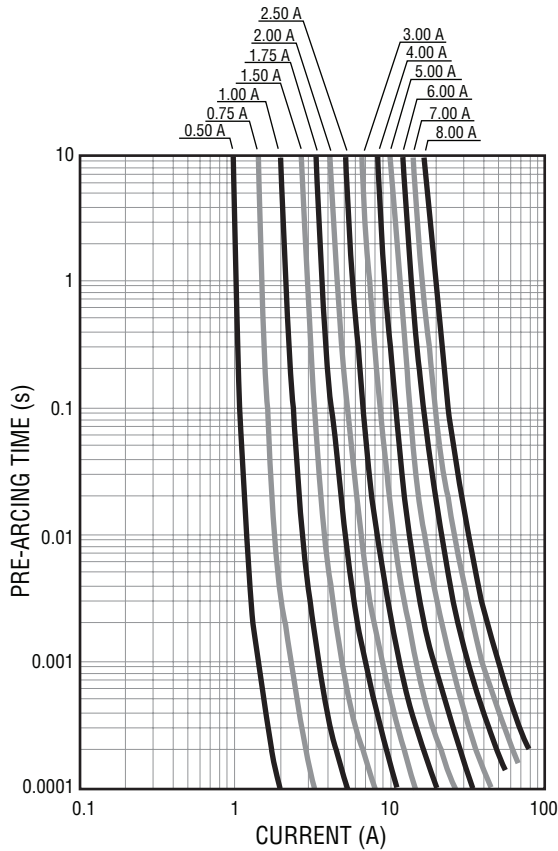

Average I²t vs. t Curves

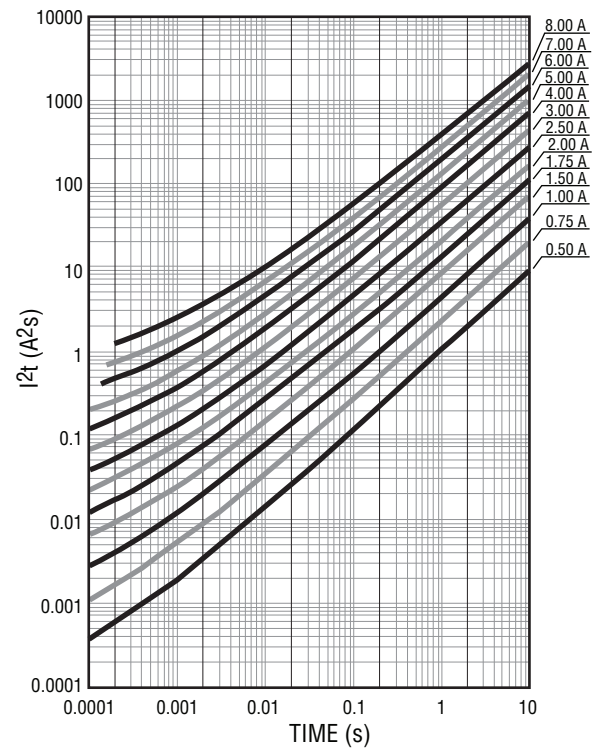

REV. B 02/18/18

Specifications are subject to change without notice.

The device characteristics and parameters in this data sheet can and do vary in different applications and actual device performance may vary over time. Users should verify actual device performance in their specific applications.

SF-1206SxxxM Series Tape and Reel Specifications

BOURNS®

SF-1206SxxxM Series
per EIA 481-2

Tape Dimensions

W	$\frac{8.00 \pm 0.10}{(.315 \pm .004)}$
P ₀	$\frac{4.0 \pm 0.10}{(.157 \pm .004)}$
P ₁	$\frac{4.0 \pm 0.10}{(.157 \pm .004)}$
P ₂	$\frac{2.0 \pm 0.05}{(.079 \pm .002)}$
A ₀	$\frac{1.80 \pm 0.10}{(.071 \pm .004)}$
B ₀	$\frac{3.50 \pm 0.10}{(.138 \pm .004)}$
F	$\frac{3.50 \pm 0.05}{(.138 \pm .002)}$
E ₁	$\frac{1.75 \pm 0.10}{(.069 \pm .004)}$
D ₀	$\frac{1.50 \pm 0.10}{(.059 \pm .004)}$
K ₀	$\frac{1.10 \pm 0.10}{(.043 \pm .004)}$
T	$\frac{0.23 \pm 0.20}{(.009 \pm .008)}$

PACKAGING: Plastic tape, 3,000 pcs. per reel

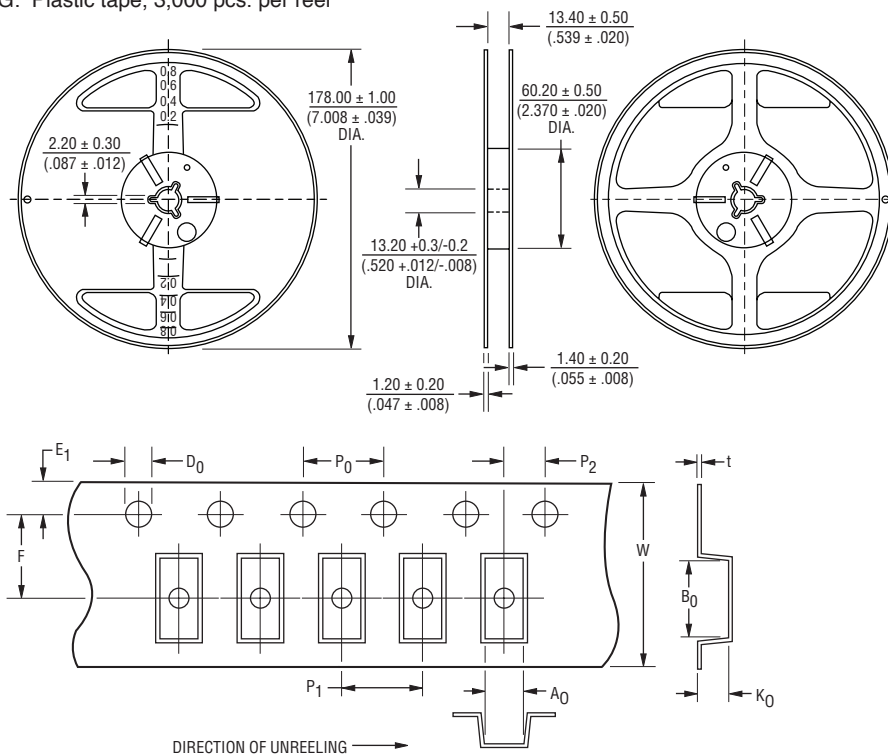

DIMENSIONS: $\frac{\text{MM}}{\text{(INCHES)}}$

Specifications are subject to change without notice.

The device characteristics and parameters in this data sheet can and do vary in different applications and actual device performance may vary over time. Users should verify actual device performance in their specific applications.