

Spring Contact SCTA_A Series (Standard Type)

Dimensions (W × D)	1.4 × 1.4mm
Height in use	0.8 to 1.2mm
Travel	0.6mm
Mounting type	Surface mounting type
Mounting style	Standard mount
Packing system	Taping
Minimum order unit (pcs.)	13,000
Operating temperature range	-30°C to +85°C
Rated current	3A
Contact resistance (Initial)	Connector contacts 40mΩ max.
Stroke Frequency	500 times

Dimensions

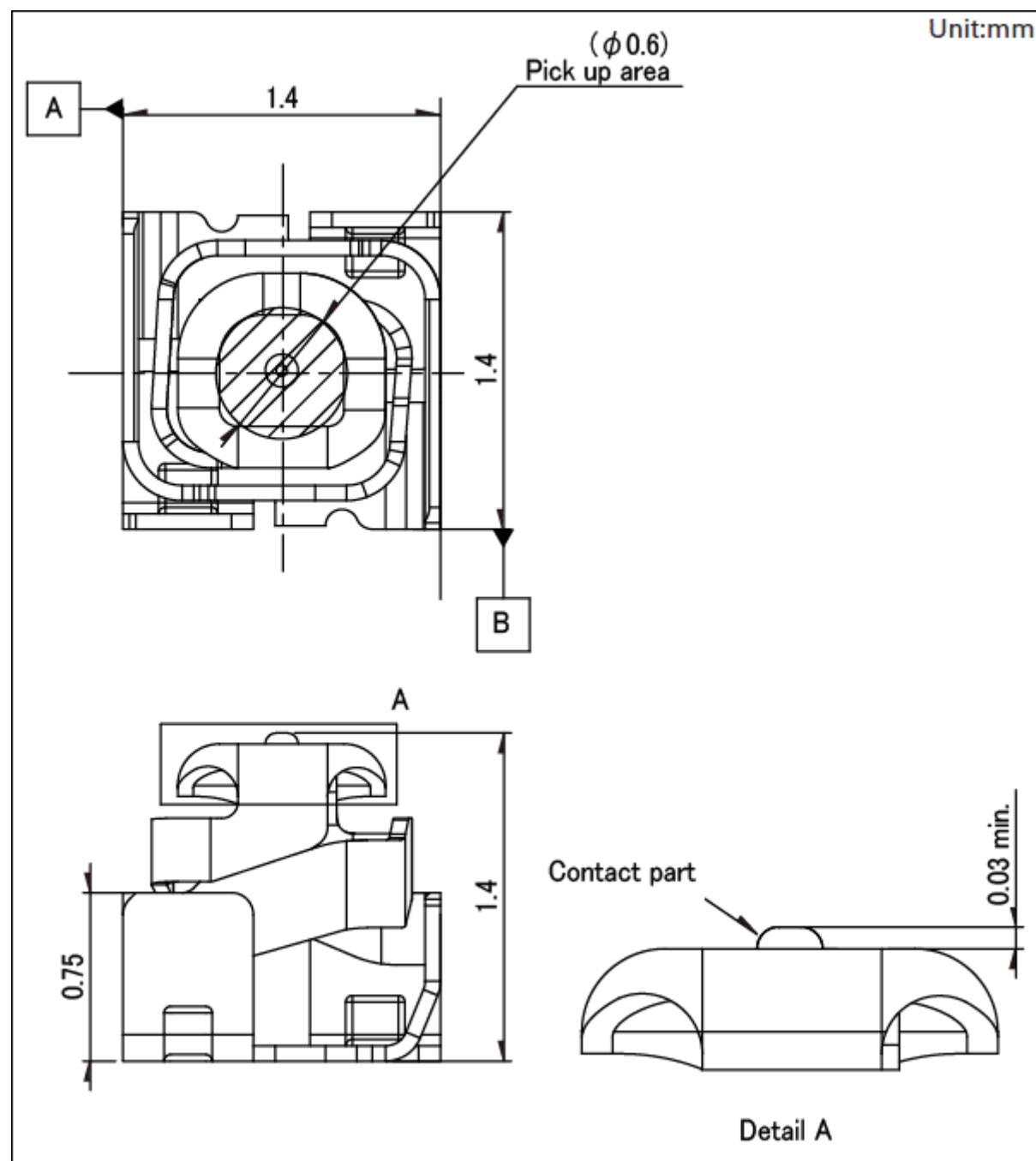

Land Dimensions

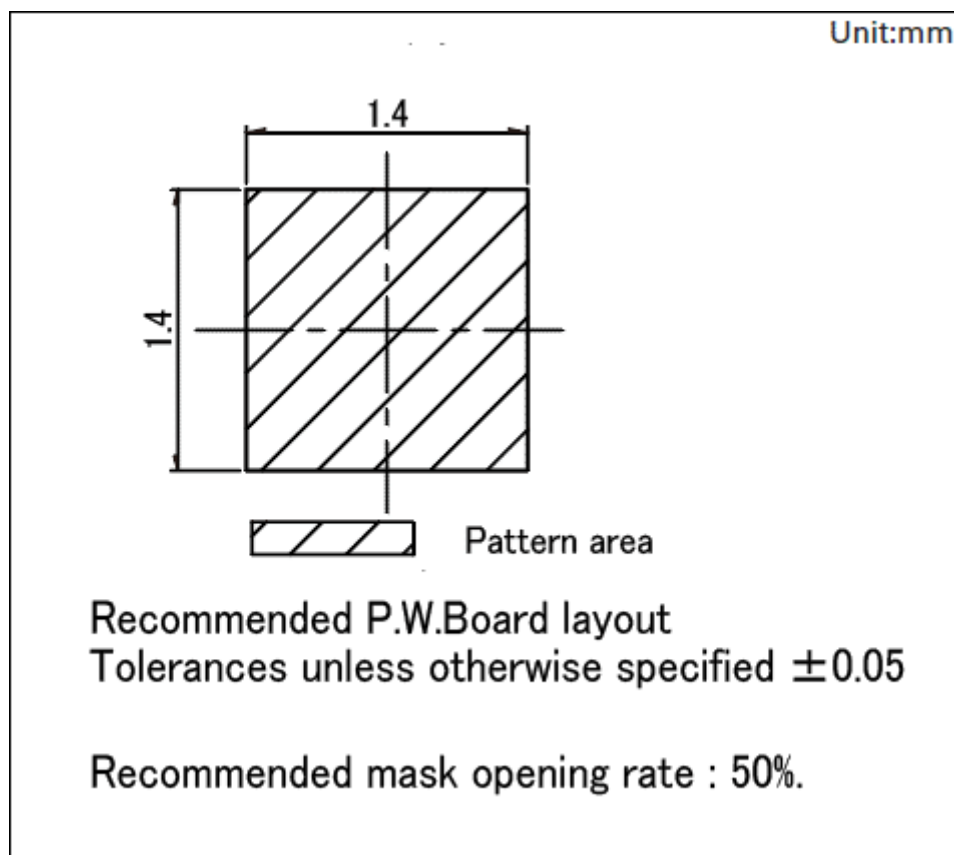

Packing Specifications

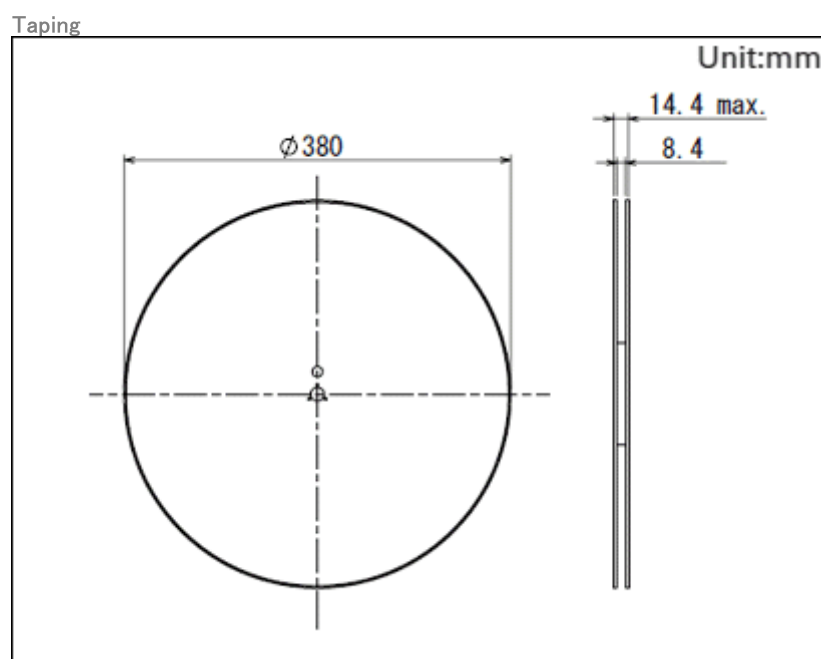

Number of packages (pcs.)	1 reel	13,000
	1 case / Japan	39,000
	1 case / export packing	78,000
Tape width (mm)	8	
Export package measurements (mm)	403 × 403 × 167	

Soldering Conditions

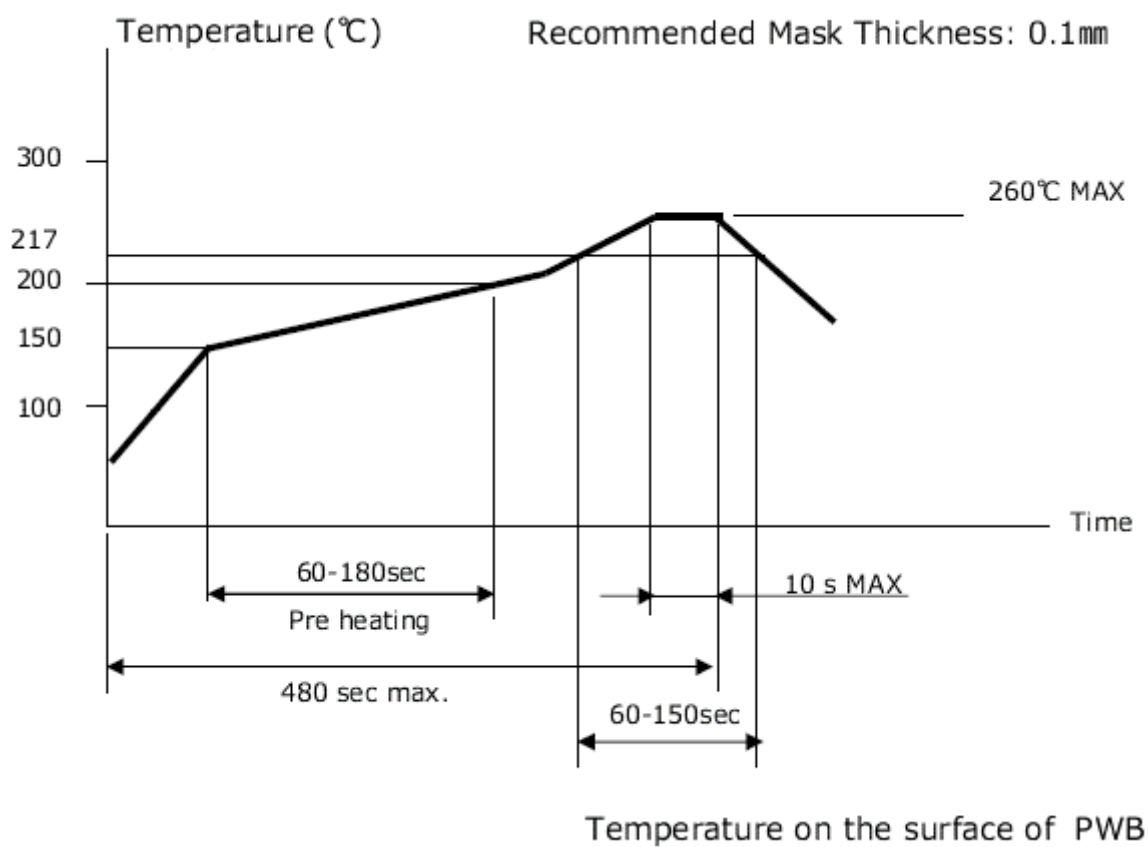

Notes are common to this series/models.

1. This site catalog shows only outline specifications. When using the products, please obtain formal specifications for supply.
2. Please place purchase orders per minimum order unit (integer).