

Part Number: SC43-11EWA

High Efficiency Red

Features

- 0.43 INCH DIGIT HEIGHT.
- LOW CURRENT OPERATION.
- EXCELLENT CHARACTER APPEARANCE.
- EASY MOUNTING ON P.C. BOARDS OR SOCKETS.
- I.C. COMPATIBLE.
- MECHANICALLY RUGGED.
- STANDARD : GRAY FACE, WHITE SEGMENT.
- RoHS COMPLIANT.

Description

The High Efficiency Red source color devices are made with Gallium Arsenide Phosphide on Gallium Phosphide Orange Light Emitting Diode.

Package Dimensions & Internal Circuit Diagram

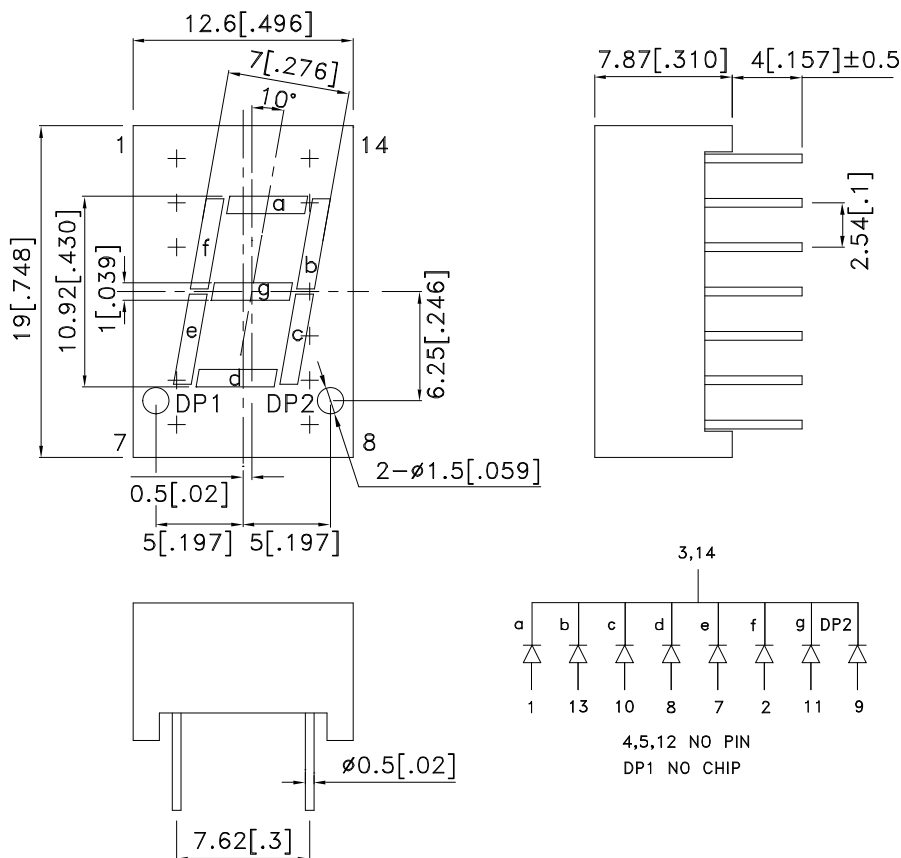

Notes:

1. All dimensions are in millimeters (inches), Tolerance is ±0.25(0.01") unless otherwise noted.
2. Specifications are subject to change without notice.



Selection Guide

| Part No. | Dice | Lens Type | Iv (ucd) [1] @ 10mA | | Description |
|------------|---------------------------------|----------------|------------------------|------|-----------------------------------|
| | | | Min. | Typ. | |
| SC43-11EWA | High Efficiency Red (GaAsP/GaP) | WHITE DIFFUSED | 1200 | 4700 | Common Cathode, Rt. Hand Decimal. |

Note:

1. Luminous intensity/ luminous Flux: +/-15%.

Electrical / Optical Characteristics at TA=25°C

| Symbol | Parameter | Device | Typ. | Max. | Units | Test Conditions |
|-----------------------|--------------------------|---------------------|------|------|-------|---------------------------|
| λ_{peak} | Peak Wavelength | High Efficiency Red | 627 | | nm | I _F =20mA |
| λ_D [1] | Dominant Wavelength | High Efficiency Red | 625 | | nm | I _F =20mA |
| $\Delta\lambda_{1/2}$ | Spectral Line Half-width | High Efficiency Red | 45 | | nm | I _F =20mA |
| C | Capacitance | High Efficiency Red | 15 | | pF | V _F =0V;f=1MHz |
| V _F [2] | Forward Voltage | High Efficiency Red | 2.0 | 2.5 | V | I _F =20mA |
| I _R | Reverse Current | High Efficiency Red | | 10 | uA | V _R =5V |

Notes:

- 1.Wavelength: +/-1nm.
2. Forward Voltage: +/-0.1V.

Absolute Maximum Ratings at TA=25°C

| Parameter | High Efficiency Red | Units |
|---------------------------------|-----------------------|-------|
| Power dissipation | 75 | mW |
| DC Forward Current | 30 | mA |
| Peak Forward Current [1] | 160 | mA |
| Reverse Voltage | 5 | V |
| Operating / Storage Temperature | -40°C To +85°C | |
| Lead Solder Temperature[2] | 260°C For 3-5 Seconds | |

Notes:

1. 1/10 Duty Cycle, 0.1ms Pulse Width.
2. 2mm below package base.

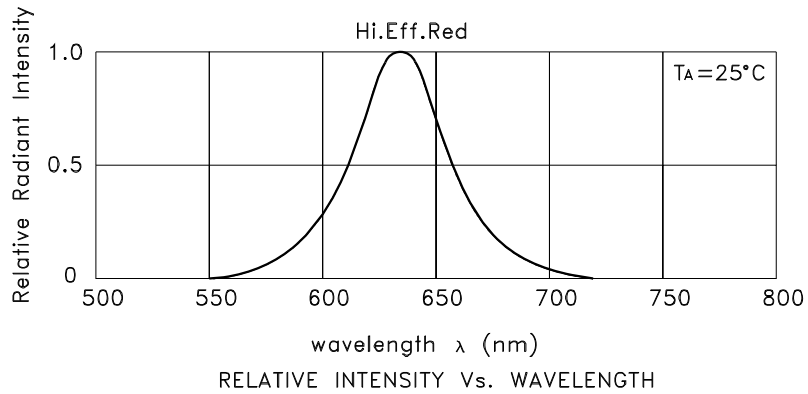

High Efficiency Red SC43-11EWA

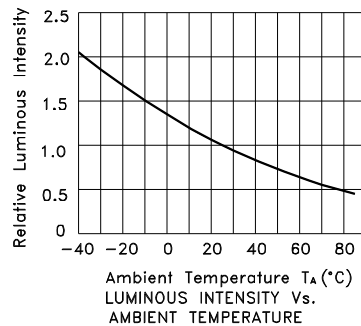
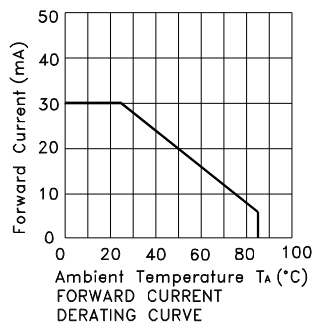
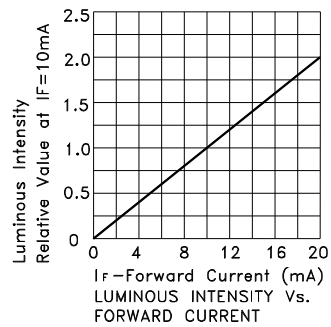
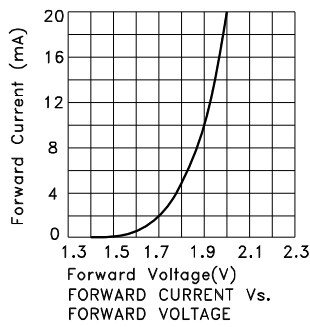

PACKING & LABEL SPECIFICATIONS

SC43-11EWA

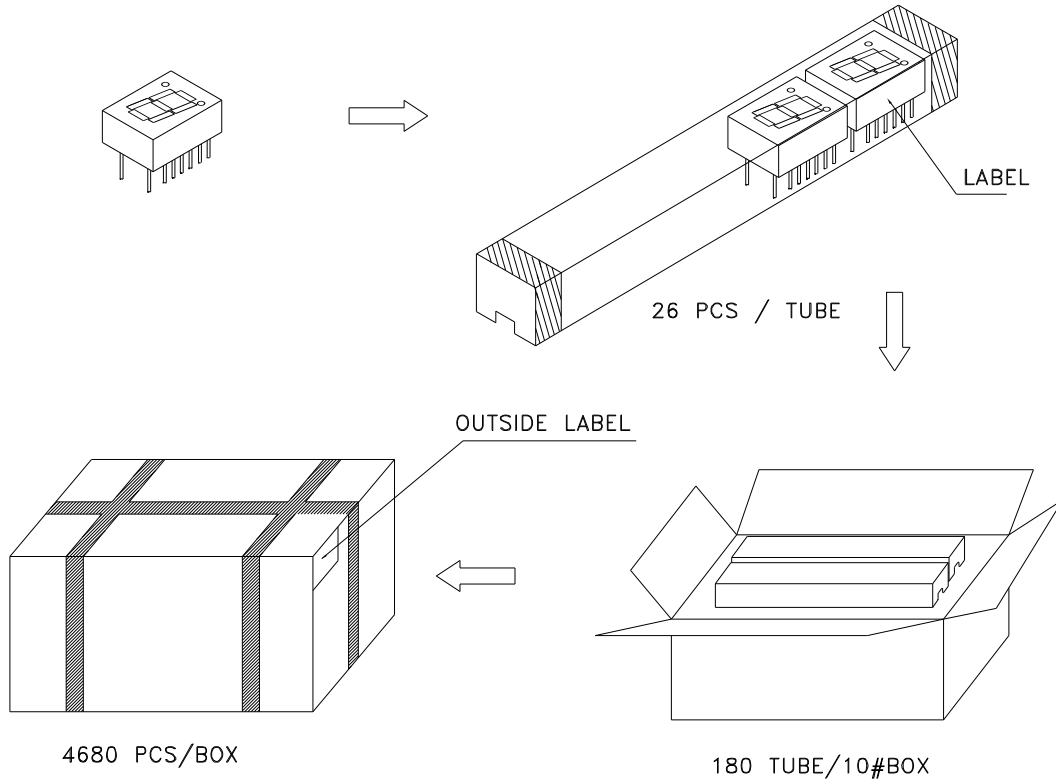

Inside LABEL Paste On The IC-TUBE

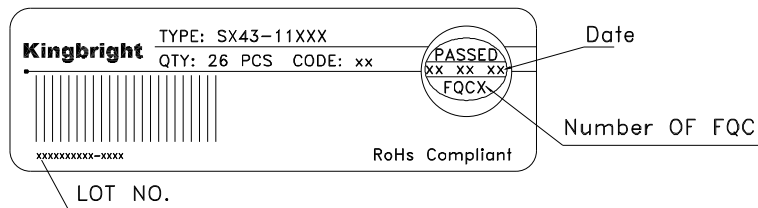

Outside LABEL Paste On The Box

