

Part Number: SC10-11YWA

Yellow

Features

- 1.02 inch digit height.
- Low current operation.
- Excellent character appearance.
- High light output.
- Easy mounting on P.C. boards or sockets.
- Mechanically rugged.
- Standard : gray face, white segment.
- RoHS compliant.

Description

The Yellow source color devices are made with Gallium Arsenide Phosphide on Gallium Phosphide Yellow Light Emitting Diode.

Package Dimensions & Internal Circuit Diagram

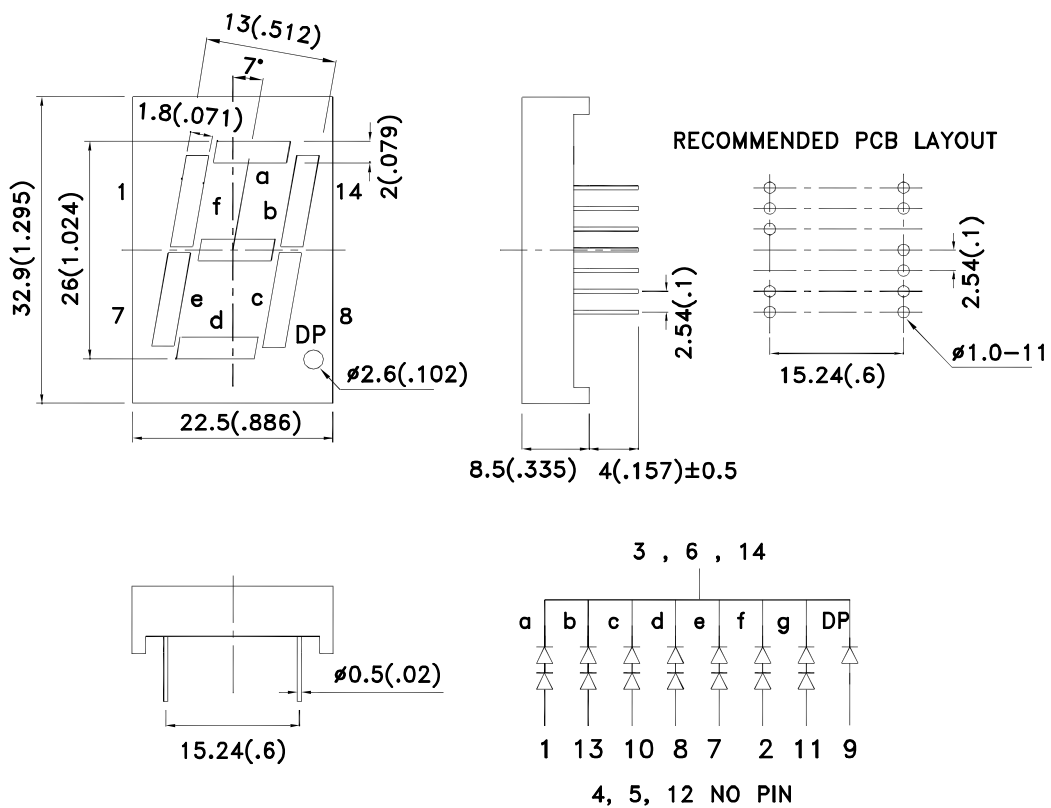

Notes:

1. All dimensions are in millimeters (inches), Tolerance is ±0.25(0.01") unless otherwise noted.
2. Specifications are subject to change without notice.



Selection Guide

Part No.	Dice	Lens Type	Iv (ucd) [1] @ 10mA		Description
			Min.	Typ.	
SC10-11YWA	Yellow (GaAsP/GaP)	WHITE DIFFUSED	8000	24000	Common Cathode, Rt. Hand Decimal.

Note:

1. Luminous intensity/ luminous Flux: +/-15%.

Electrical / Optical Characteristics at TA=25°C

Symbol	Parameter	Device	Typ.	Max.	Units	Test Conditions
λ_{peak}	Peak Wavelength	Yellow	590		nm	IF=20mA
λ_D [1]	Dominant Wavelength	Yellow	588		nm	IF=20mA
$\Delta\lambda_{1/2}$	Spectral Line Half-width	Yellow	35		nm	IF=20mA
C	Capacitance	Yellow	20		pF	VF=0V;f=1MHz
VF [2]	Forward Voltage Per Segment Or (DP)	Yellow	4.2 (2.1)	5.0 (2.5)	V	IF=20mA
IR	Reverse Current Per Segment Or (DP)	Yellow		10 (10)	uA	VR=10V (VR=5V)

Notes:

1. Wavelength: +/-1nm.

2. Forward Voltage: +/-0.1V.

Absolute Maximum Ratings at TA=25°C

Parameter	Yellow	Units
Power dissipation Per Segment Or (DP)	150 (75)	mW
DC Forward Current Per Segment Or (DP)	30 (30)	mA
Peak Forward Current [1] Per Segment Or (DP)	140 (140)	mA
Reverse Voltage Per Segment Or (DP)	10 (5)	V
Operating / Storage Temperature	-40°C To +85°C	
Lead Solder Temperature[2]	260°C For 3-5 Seconds	

Notes:

1. 1/10 Duty Cycle, 0.1ms Pulse Width.

2. 2mm below package base.

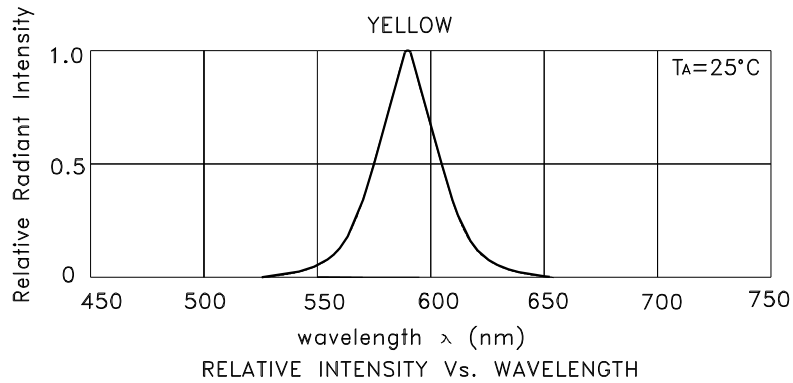

Yellow

SC10-11YWA

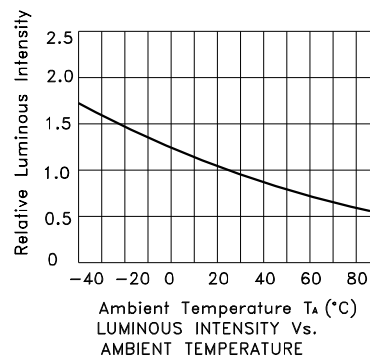
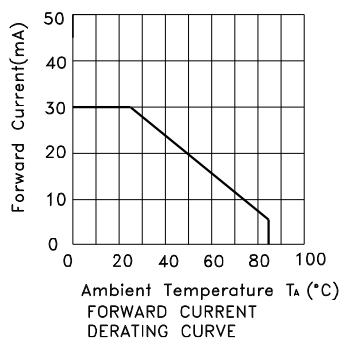
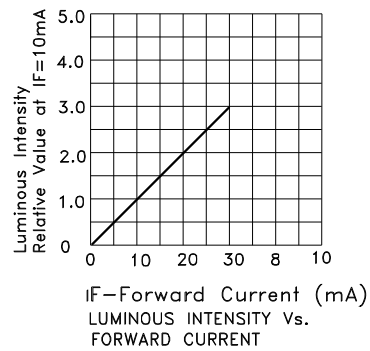
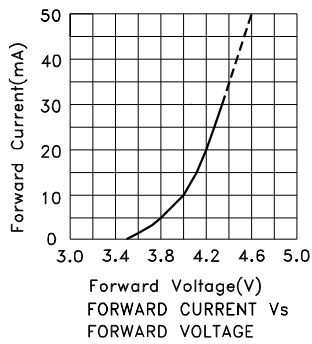

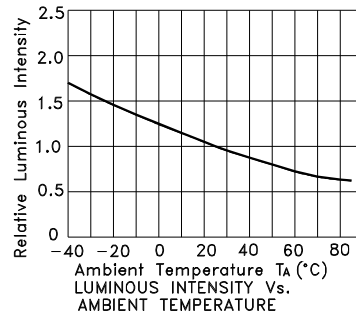
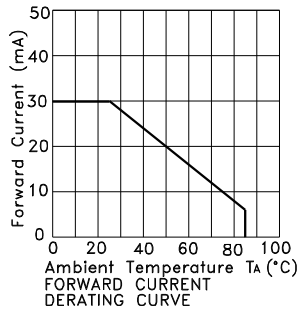
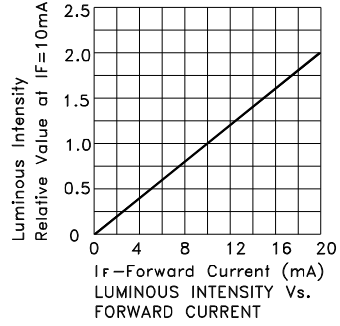
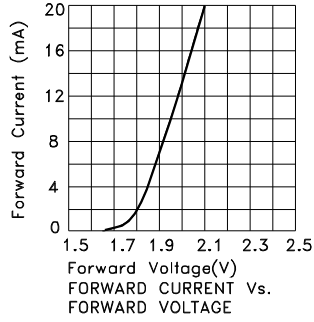

PACKING & LABEL SPECIFICATIONS

SC10-11YWA

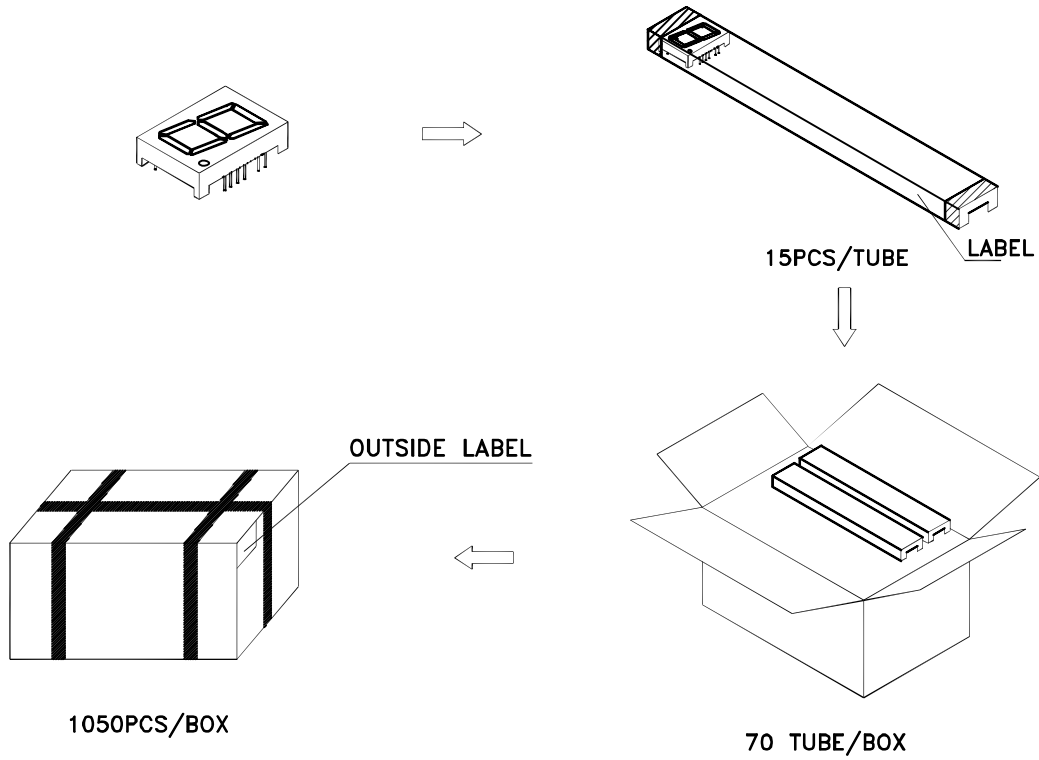

Inside Label Paste On The IC-tube

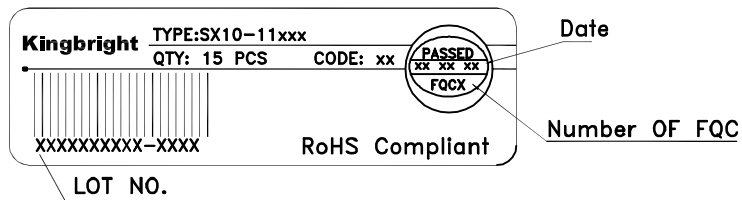

Outside Label Paste On The Box

