

S Series
Dual Seal
Waterproof Toggle



IP68 Rated

General Specifications

Electrical Capacity (Resistive Load)

Power Level: Shown in following tables

Other Ratings

Contact Resistance:	10 milliohms maximum
Insulation Resistance:	1,000 megohms minimum @ 500V DC
Dielectric Strength:	2,000V AC minimum for 1 minute minimum
Mechanical Life:	50,000 operations minimum for S1AWB, S2AWB, S3AWB, S6AWB, S7AWB, S21AWB 30,000 operations minimum for S5AWB, S8AWB, S25AWB, S28AWB
Electrical Life:	25,000 operations minimum
Angle of Throw:	Shown in following tables

Environmental Data

Operating Temperature Range:	-30°C through +70°C (-22°F through +158°F)
Sealing:	Waterproofing, achieved with boot at base of lever plus o-rings inside and outside of bushing, meets IP68 of IEC60529 Standards (dust tight and protection against effects of temporary immersion). See further explanation on last page.

Processing

Soldering: Manual Soldering: 390°C for 4 seconds, 2 cycles

Distinctive Characteristics

Dual protection with internal o-ring and external rubber washer, sealing the switch to achieve IP68 of IEC60529 Standards (dust tight and water protected against immersion for as long as 30 minutes, in 1.5 meters of water).

Additional panel seal security against wet environments provided by waterproof boot at base of toggle.



Fluid actuation delivered in smooth, sturdy tactile feel.

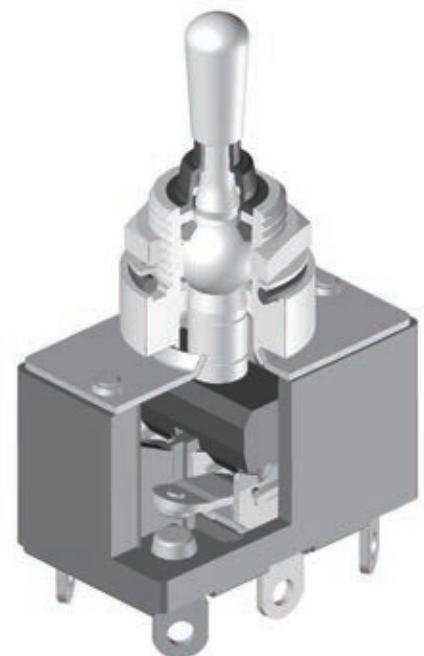

Sleek design incorporates functionality with polished, chrome-plated actuator paired with waterproof boot.

Superb quality and construction design prohibit entry of foreign particles that may otherwise compromise lever operation.







SINGLE POLE WITH SOLDER LUG

Model	Pole & Throw	Toggle Position/Connected Terminals () = Momentary					Electrical Capacity			$\alpha =$ Angle of Throw
		Down		Center	Up		Resistive			
							AC 125V	AC 250V	DC 30V	
S1AWB	SPST	ON	1-3	NONE	OFF	—	15A	6A	20A	$24^\circ \pm 4^\circ$
S2AWB	SPDT	ON	2-3	NONE	ON	2-1	15A	6A	20A	$24^\circ \pm 4^\circ$
S3AWB	SPDT	ON	2-3	OFF	ON	2-1	15A	6A	20A	$24^\circ \pm 4^\circ$
S5AWB	SPDT	ON	2-3	NONE	(ON)	2-1	15A	6A	20A	$20^\circ \pm 4^\circ$
S8AWB	SPDT	(ON)	2-3	OFF	(ON)	2-1	15A	6A	20A	24°

Throw & Schematics: SPST  INTERNAL CONNECTION SPDT  Note: Terminal numbers are actually on the switch

DOUBLE POLE WITH SOLDER LUG

Model	Pole & Throw	Toggle Position/Connected Terminals () = Momentary							Electrical Capacity			$\alpha =$ Angle of Throw
		Down		Center	Up		Resistive					
							AC 125V	AC 250V	DC 30V			
S21AWB	DPST	ON	1-3 4-6	NONE	OFF	—	—	15A	15A	15A	$24^\circ \pm 4^\circ$	
S6AWB	DPDT	ON	2-3 5-6	NONE	ON	2-1	5-4	15A	10A	20A	$24^\circ \pm 4^\circ$	
S7AWB	DPDT	ON	2-3 5-6	OFF	ON	2-1	5-4	15A	10A	20A	$24^\circ \pm 4^\circ$	
S25AWB	DPDT	ON	2-3 5-6	NONE	(ON)	2-1	5-4	15A	6A	20A	$20^\circ \pm 4^\circ$	
S28AWB	DPDT	(ON)	2-3 5-6	OFF	(ON)	2-1	5-4	15A	6A	20A	$24^\circ \pm 4^\circ$	

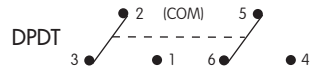
Throw & Schematics: DPST  INTERNAL CONNECTION DPDT  Note: Terminal numbers are actually on the switch

STANDARD HARDWARE

AT503M Hex Face Nut
Brass with Chrome Plating

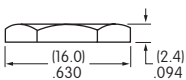
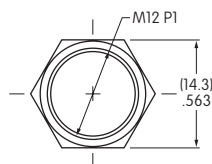

Lockwasher
Phosphor Bronze/Chromate

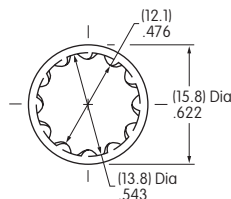

AT537 O-ring
Nitrile Butadiene Rubber

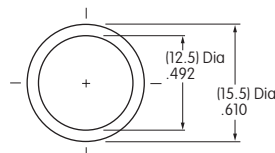

PANEL CUTOUT

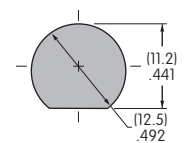

Anti-rotation

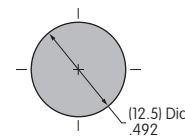

No Anti-rotation

Maximum Effective Panel Thickness
.157" (4.0mm)

TYPICAL SWITCH DIMENSIONS

Solder Lug



S2AWB

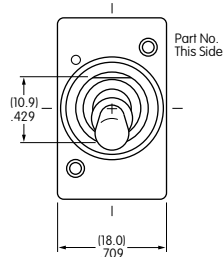

Single Pole

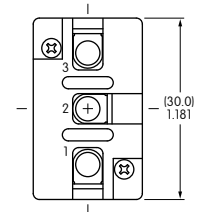
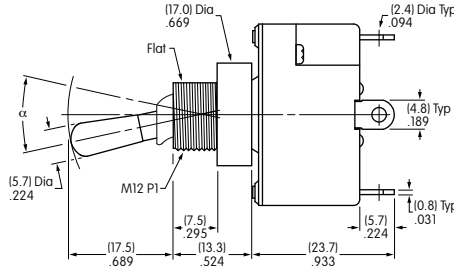

S1AWB does not have terminal 2

Solder Lug



S6AWB

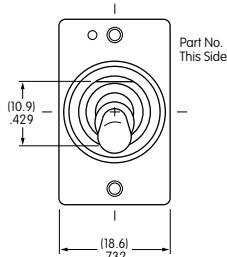

Double Pole

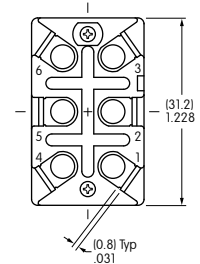
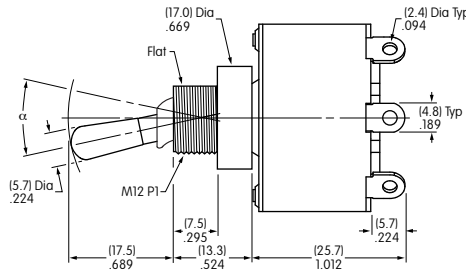

S21AWB does not have terminals 2 & 5

APPLICATION CONSIDERATIONS

The Dual Seal Waterproof S Toggle is designed as a panel seal switch, and not to be used under water.

Material Properties

The material for the waterproof boot is silicone rubber. While silicone rubber has excellent heat, cold and weather resistant properties, it has less durability and oil resistance.

The o-ring below the panel is made of nitrile butadiene rubber, which excels in durability and oil and chemical resistance. Its performance is less durable with lower weather and ozone resistant characteristics.

Evaluate the products in regard to your application and intended environment with these properties in mind.

Waterproof Test Conditions

Waterproofing is measured by submersing the switch 5 centimeters from the water surface (see illustration), and opening and closing 50 times at a frequency of 50 – 60 times per minute. The switch is then submersed 1.5 meters from the surface and left in this position for 30 minutes.

Repeat opening and closing

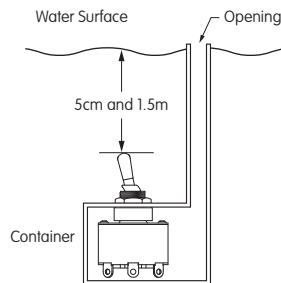

same as previous test. The resulting insulation resistance and voltage capacity are both within the rated values, and water has not entered inside the switch or installation panel.

Panel Installation

For panel installation, the internal tooth lockwasher is installed above the panel. The external o-ring mounts below the panel.

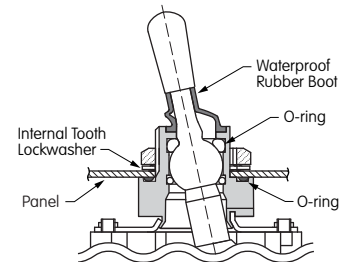

Applications

- Construction Equipment
- Hospitality and Restaurant
- Transportation
- Medical Equipment
- Machine Tooling
- Marine Equipment *

* Salt spray tested as per Mil-STD-810G section 509.5.

Effective Date October 2018

NKK

SWITCHES

7850 East Gelding Drive • Scottsdale, AZ 85260 • Telephone 480.991.0942 • Fax 480.998.1435

www.nkkswitches.com • 1.877.2BUYNKK (228.9655)