

Ferrule fuse-links 10x38 gG 400 to 690VAC

LOW VOLTAGE IEC FUSES

IEC CYLINDRICAL FUSE-LINKS



Mersen aM and gG fuse-links cover a wide range of physical sizes and ampere ratings for 400, 500, and 690VAC for protection in electrical distribution circuits and various industrial applications. Most ratings are available in size 8x31 and size 10x38 with an optional indicator, and in size 14x51 and 22x58 with an optional striker to activate an auxiliary contact. Size 10x38 is also available with striker. All cylindrical fuse-links have ceramic bodies and silver-plated contacts. Cylindrical fuse-links “gG” are used for the protection of cables, motors and LV-networks. They limit and cut off unacceptable overcurrents and short-circuit currents up to their nominal breaking capacity. Cylindrical fuse-links “gG” also protect electrical equipment and installations against the dynamic effect of high short-currents. Our technology and process was designed to ensure highly reliable technical performance.

TECHNICAL DATA OVERVIEW

Voltage Range AC	400 ... 690 VAC
Ampere Range (A)	0.5 ... 32 A
Speed/Characteristic	gG
I.R. AC (IEC)	120 kA
Body Material	Ceramic
Body Style	cylindrical
Contact Materials	Silver plated copper
Product Size	10x38 mm

FEATURES & BENEFITS

- Reduced size
- Full range protection
- Visual indication of fuse operation
- Safest and most reliable protection system

APPLICATIONS

- gG type for protection of line, cable against overload and short circuit in various industrial application and electrical distribution circuits.

STANDARDS

- IEC 60269-1 & -2 (electrically only for the range with striker)
- Approved by Lloyd’s Register of Shipping and Bureau Veritas



Ferrule fuse-links 10x38 gG 400 to 690VAC

PRODUCT RANGE

Size 10,3x38 gG 400/500VAC without indicator



FR10GG50V6



FR10GG40V32

Catalog number	Reference number	Rated voltage AC (IEC)	Rated current I _n	Rated breaking capacity AC	Power dissipation at I _n	Weight
FR10GG50V0.5	C211027	500 V	0.5 A	120 kA	0.07 W	8.3 g
FR10GG50V1	B212061	500 V	1 A	120 kA	0.45 W	8.3 g
FR10GG50V2	D213098	500 V	2 A	120 kA	0.5 W	8.3 g
FR10GG50V4	X213598	500 V	4 A	120 kA	0.85 W	8.3 g
FR10GG50V6	K215128	500 V	6 A	120 kA	0.95 W	8.3 g
FR10GG50V8	D217169	500 V	8 A	120 kA	1.15 W	8.3 g
FR10GG50V12	W219761	500 V	12 A	120 kA	1.4 W	8.3 g
FR10GG50V10	S218194	500 V	10 A	120 kA	1.3 W	8.3 g
FR10GG50V16	G200750	500 V	16 A	120 kA	1.9 W	8.3 g
FR10GG50V20	D211028	500 V	20 A	120 kA	2.4 W	8.3 g
FR10GG50V25	E213099	500 V	25 A	120 kA	2.7 W	8.3 g
FR10GG40V32	A214107	400 V	32 A	120 kA	2.8 W	8.3 g

Size 10,3x38 gG 400/500VAC with indicator



FR10GG40V32I

Catalog number	Reference number	Rated voltage AC (IEC)	Rated current I _n	Rated breaking capacity AC	Power dissipation at I _n	Weight
FR10GG50V2I	S216653	500 V	2 A	120 kA	0.5 W	8.3 g
FR10GG50V4I	E217170	500 V	4 A	120 kA	0.85 W	8.3 g
FR10GG50V6I	T218195	500 V	6 A	120 kA	0.95 W	8.3 g
FR10GG50V8I	V219231	500 V	8 A	120 kA	1.15 W	8.3 g
FR10GG50V10I	E222207	500 V	10 A	120 kA	1.3 W	8.3 g
FR10GG50V12I	H200751	500 V	12 A	120 kA	1.4 W	8.3 g
FR10GG50V16I	H201809	500 V	16 A	120 kA	1.9 W	8.3 g
FR10GG50V20I	X211551	500 V	20 A	120 kA	2.4 W	8.3 g
FR10GG50V25I	W212585	500 V	25 A	120 kA	2.7 W	8.3 g
FR10GG40V32I	Z213600	400 V	32 A	120 kA	2.8 W	8.3 g

Size 10,3x38 gG 250/400VAC with striker

Catalog number	Reference number	Rated voltage AC (IEC)	Rated current I _n	Rated breaking capacity AC	Power dissipation at I _n	Weight
FR10GG40V2P	G083703	400 V	2 A	100 kA	0.6 W	9.2 g
FR10GG40V4P	D084758	400 V	4 A	100 kA	0.75 W	9.2 g
FR10GG40V6P	Y084799	400 V	6 A	100 kA	0.9 W	9.2 g
FR10GG40V8P	F083955	400 V	8 A	100 kA	1 W	9.2 g
FR10GG40V10P	A084801	400 V	10 A	100 kA	1.1 W	9.2 g
FR10GG40V12P	G083956	400 V	12 A	100 kA	1.25 W	9.2 g
FR10GG40V16P	X084798	380 V	16 A	100 kA	1.35 W	9.2 g
FR10GG40V20P	Z084800	380 V	20 A	100 kA	1.45 W	9.2 g
FR10GG25V25P	H083957	250 V	25 A	100 kA	1.7 W	9.2 g
FR10GG25V32P	E083954	250 V	32 A	100 kA	2.2 W	9.2 g

Ferrule fuse-links 10x38 gG 400 to 690VAC

PRODUCT RANGE



FR10GG69V6

Size 10,3x38 gG 690VAC without indicator

Catalog number	Reference number	Rated voltage AC (IEC)	Rated current I _n	Rated breaking capacity AC	Power dissipation at I _n	Weight
FR10GG69V1	R302787	690 V	1 A	120 kA	0.45 W	9 g
FR10GG69V2	S302788	690 V	2 A	120 kA	0.55 W	9 g
FR10GG69V4	T302789	690 V	4 A	120 kA	0.6 W	9 g
FR10GG69V6	V302790	690 V	6 A	120 kA	0.9 W	9 g
FR10GG69V8	W302791	690 V	8 A	120 kA	1 W	9 g
FR10GG69V10	X302792	690 V	10 A	120 kA	1.15 W	9 g
FR10GG69V12	Y302793	690 V	12 A	120 kA	1.4 W	9 g
FR10GG69V16	Z302794	690 V	16 A	120 kA	1.9 W	9 g

Ferrule fuse-links 10x38 gG 400 to 690VAC

TIME CURRENT CHARACTERISTIC CURVES

Size 10x38 500V gG without striker

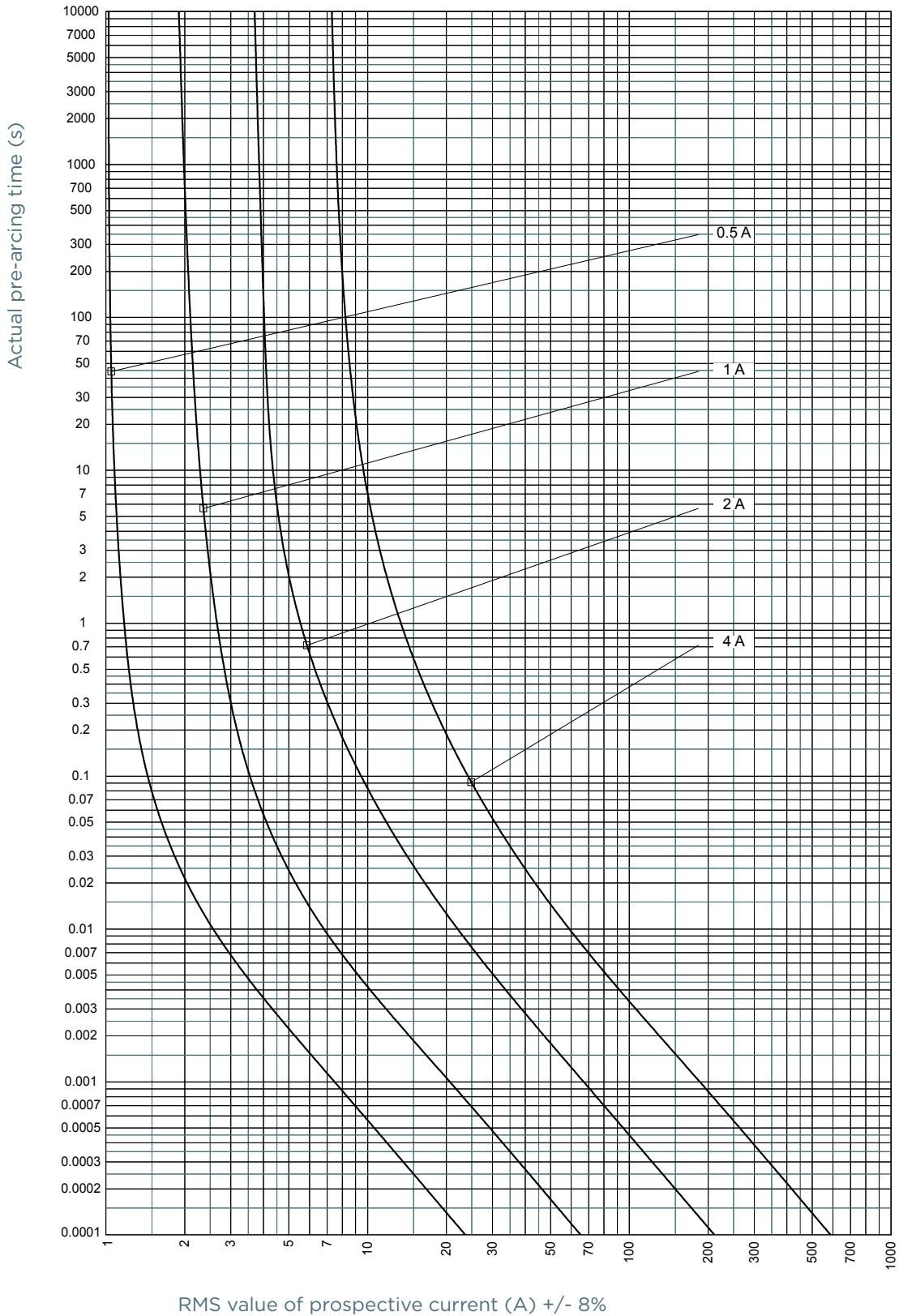

MERSEN reserves the right to change, update or correct, without notice, any information contained in this datasheet.

Ferrule fuse-links 10x38 gG 400 to 690VAC

TIME CURRENT CHARACTERISTIC CURVES

Size 10x38 500V gG without striker

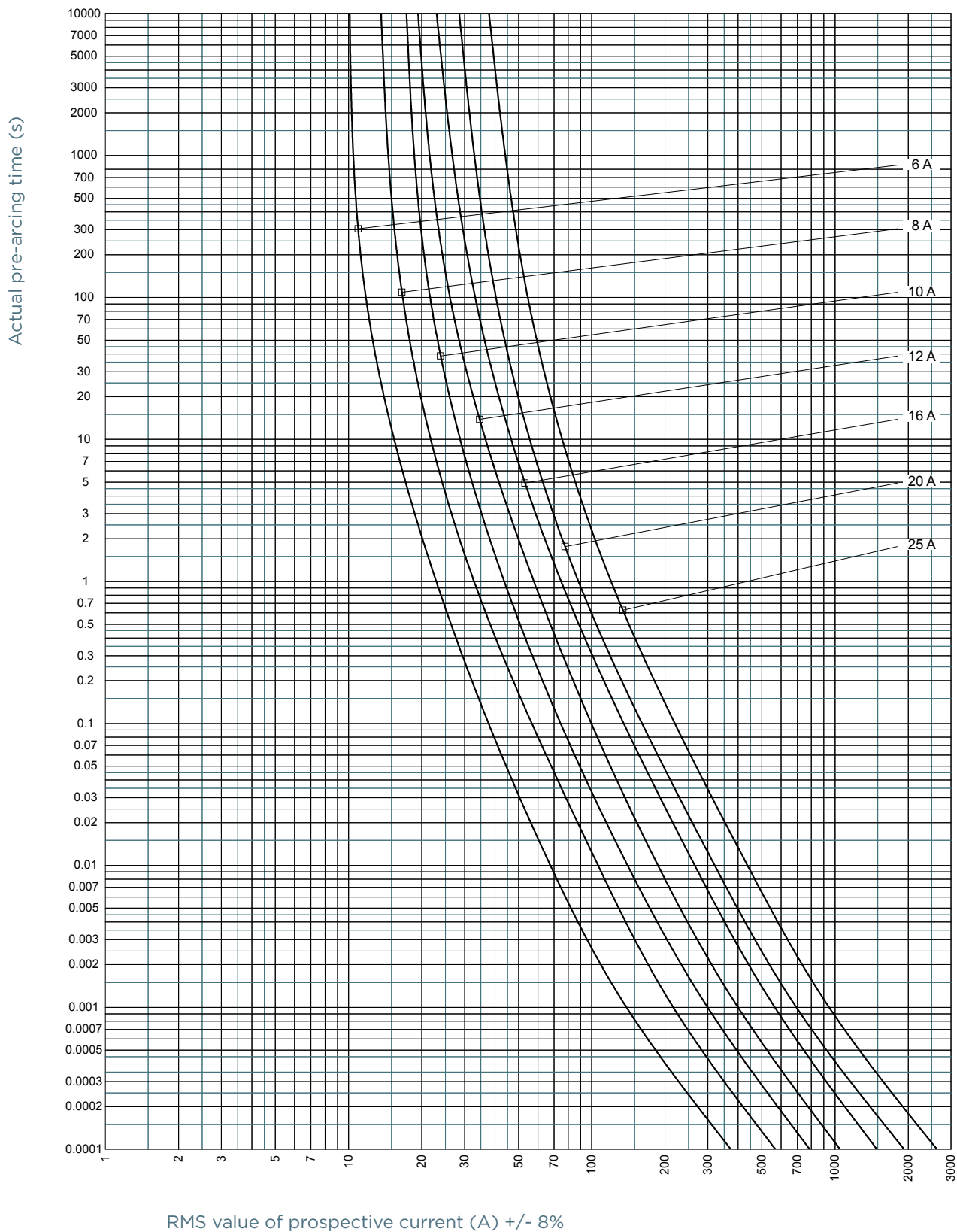

MERSEN reserves the right to change, update or correct, without notice, any information contained in this datasheet.

Ferrule fuse-links 10x38 gG 400 to 690VAC

TIME CURRENT CHARACTERISTIC CURVES

Size 10x38 400V gG without striker

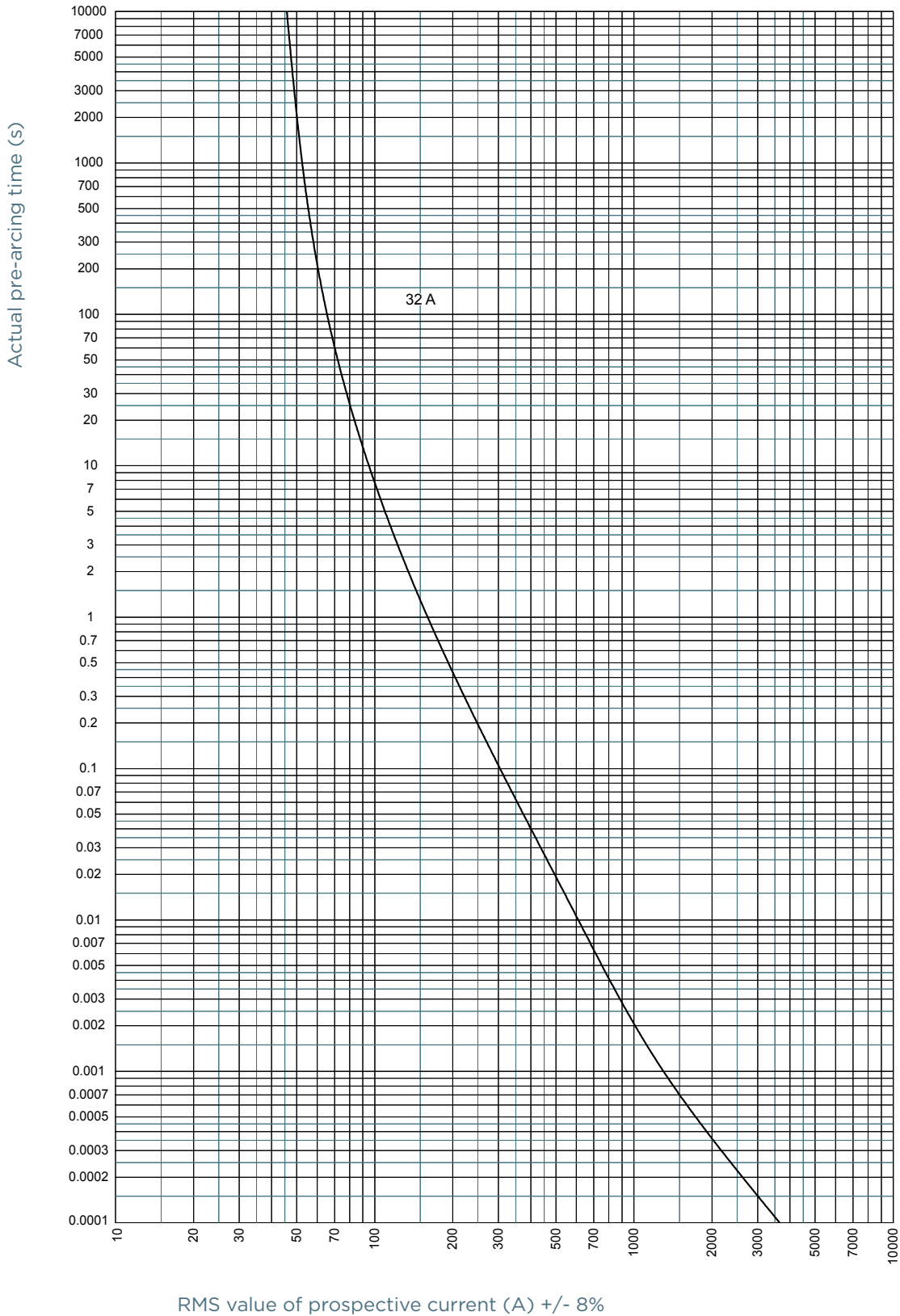

MERSEN reserves the right to change, update or correct, without notice, any information contained in this datasheet.

Ferrule fuse-links 10x38 gG 400 to 690VAC

TIME CURRENT CHARACTERISTIC CURVES

Size 10x38 690V gG without striker

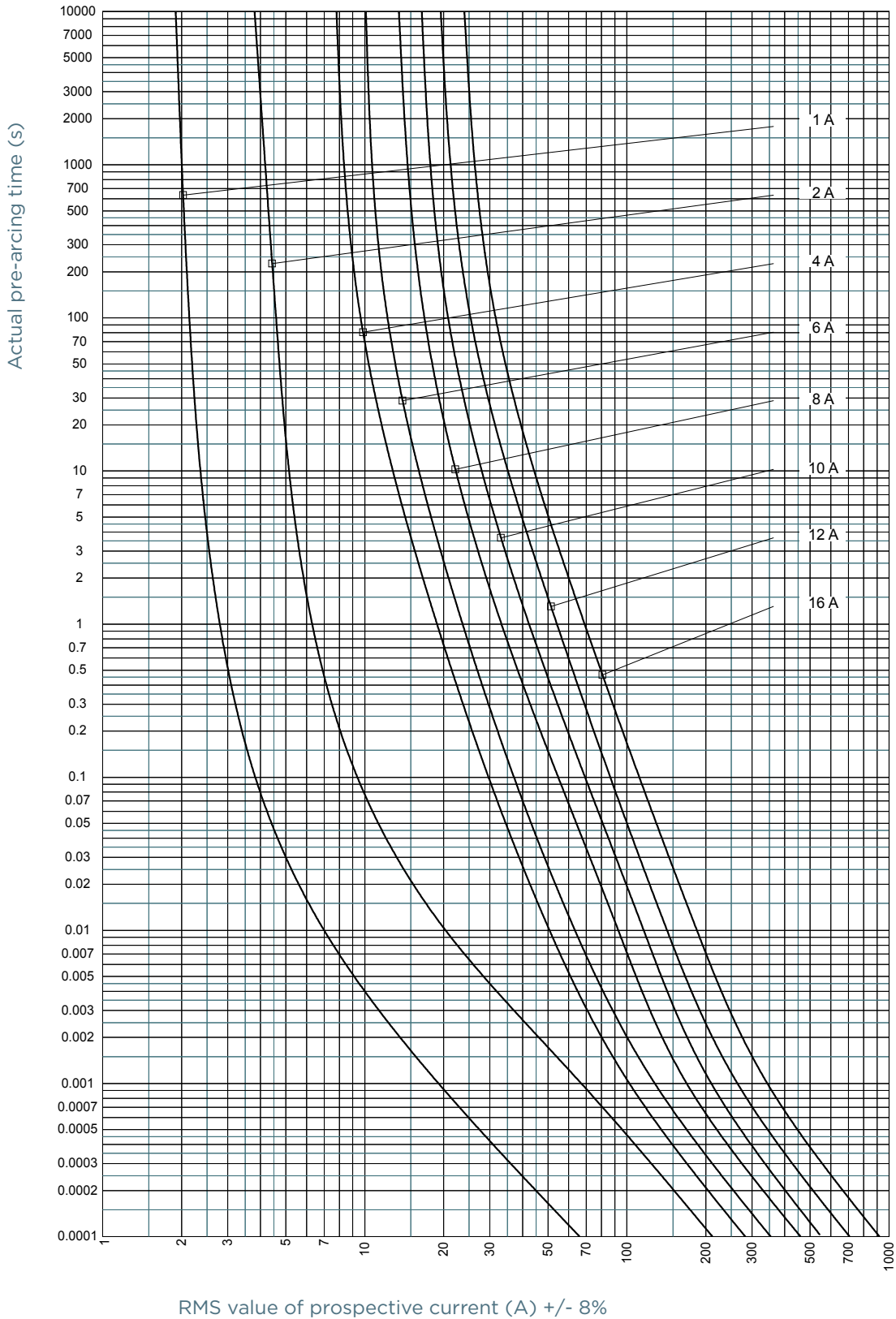

MERSEN reserves the right to change, update or correct, without notice, any information contained in this datasheet.

Ferrule fuse-links 10x38 gG 400 to 690VAC

TIME CURRENT CHARACTERISTIC CURVES

Size 10x38 400V gG with striker

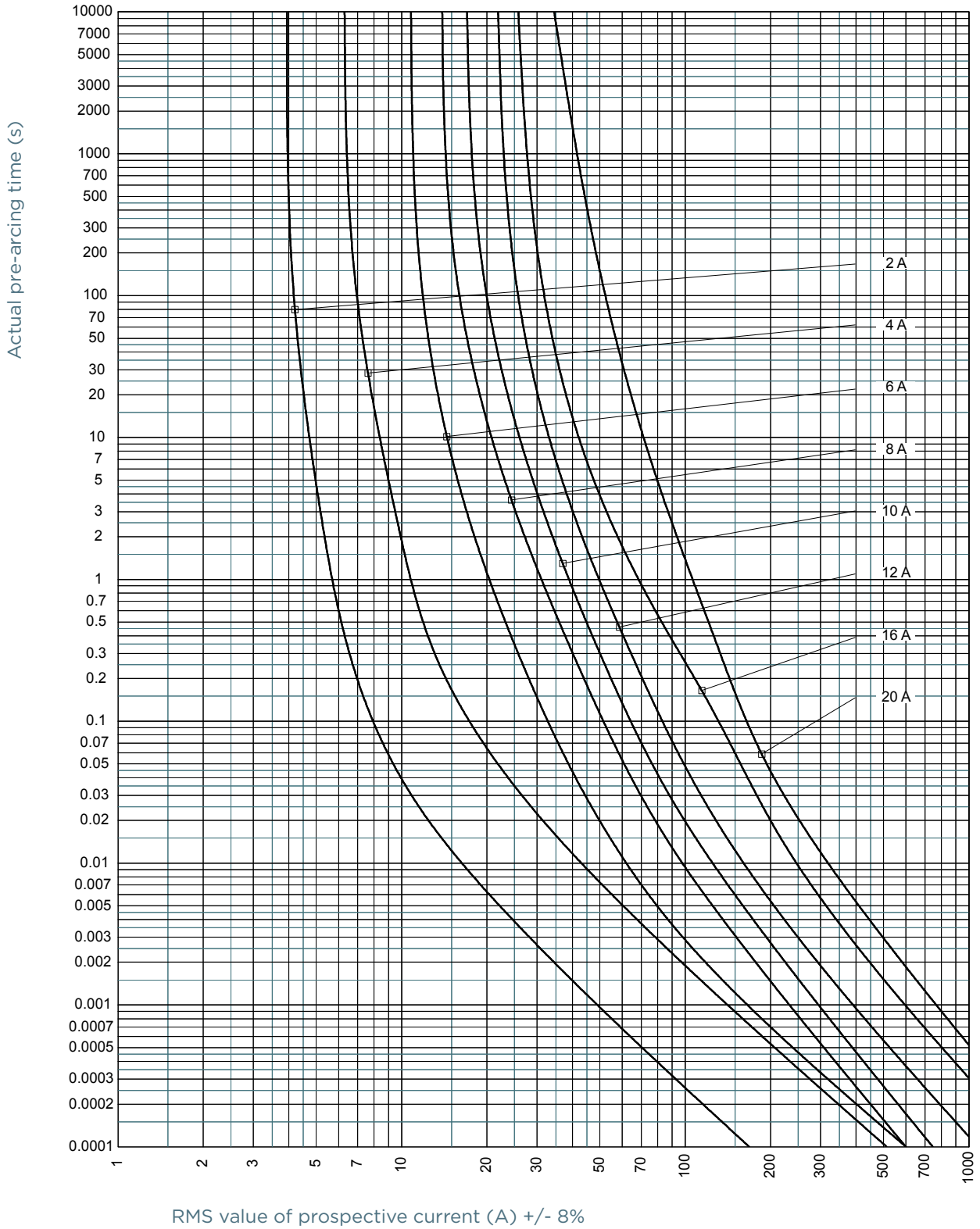

MERSEN reserves the right to change, update or correct, without notice, any information contained in this datasheet.

Ferrule fuse-links 10x38 gG 400 to 690VAC

TIME CURRENT CHARACTERISTIC CURVES

Size 10x38 250V gG with striker

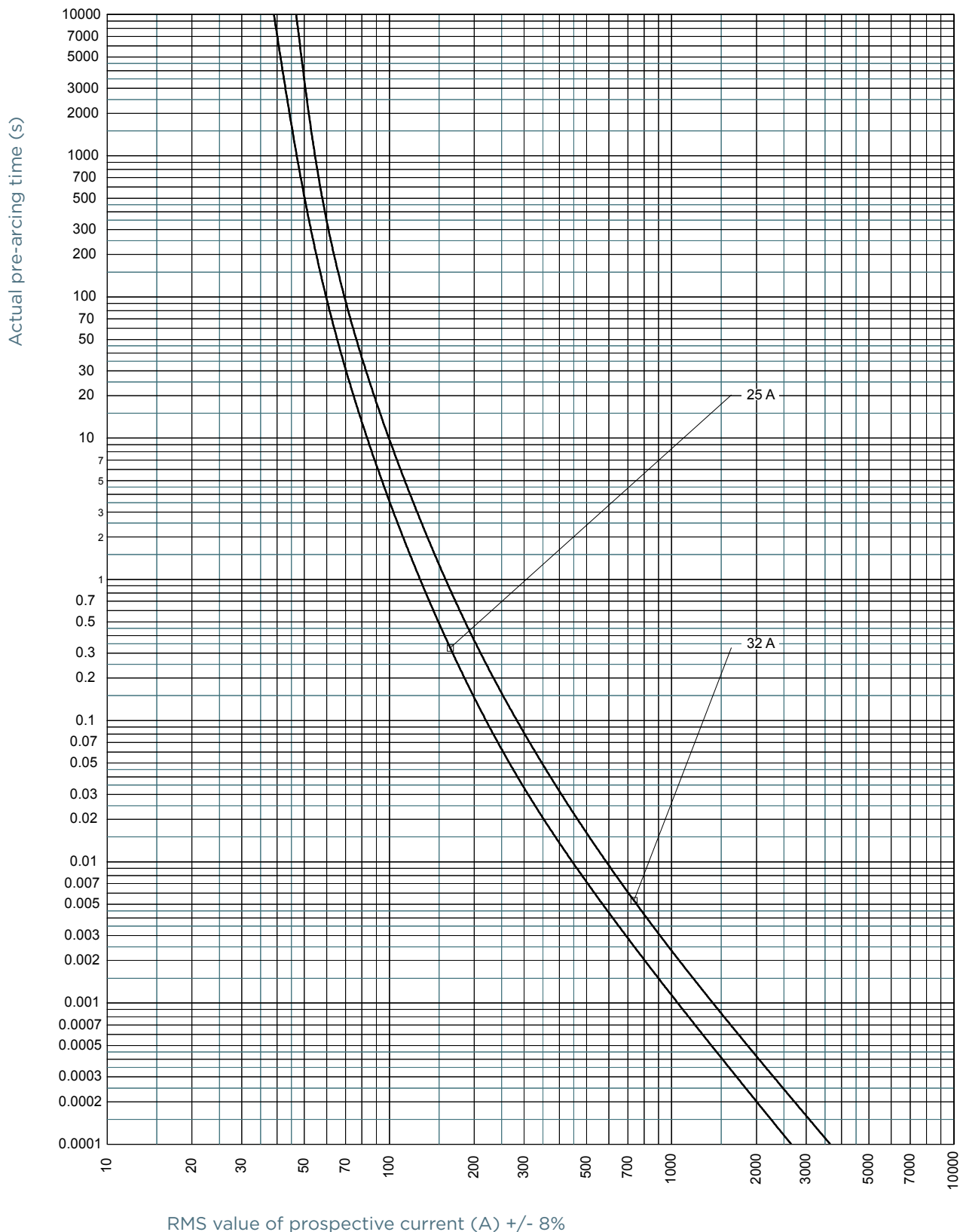

MERSEN reserves the right to change, update or correct, without notice, any information contained in this datasheet.

Ferrule fuse-links 10x38 gG 400 to 690VAC

CUT-OFF CURRENT CHARACTERISTIC

Size 10x38 500V gG without striker

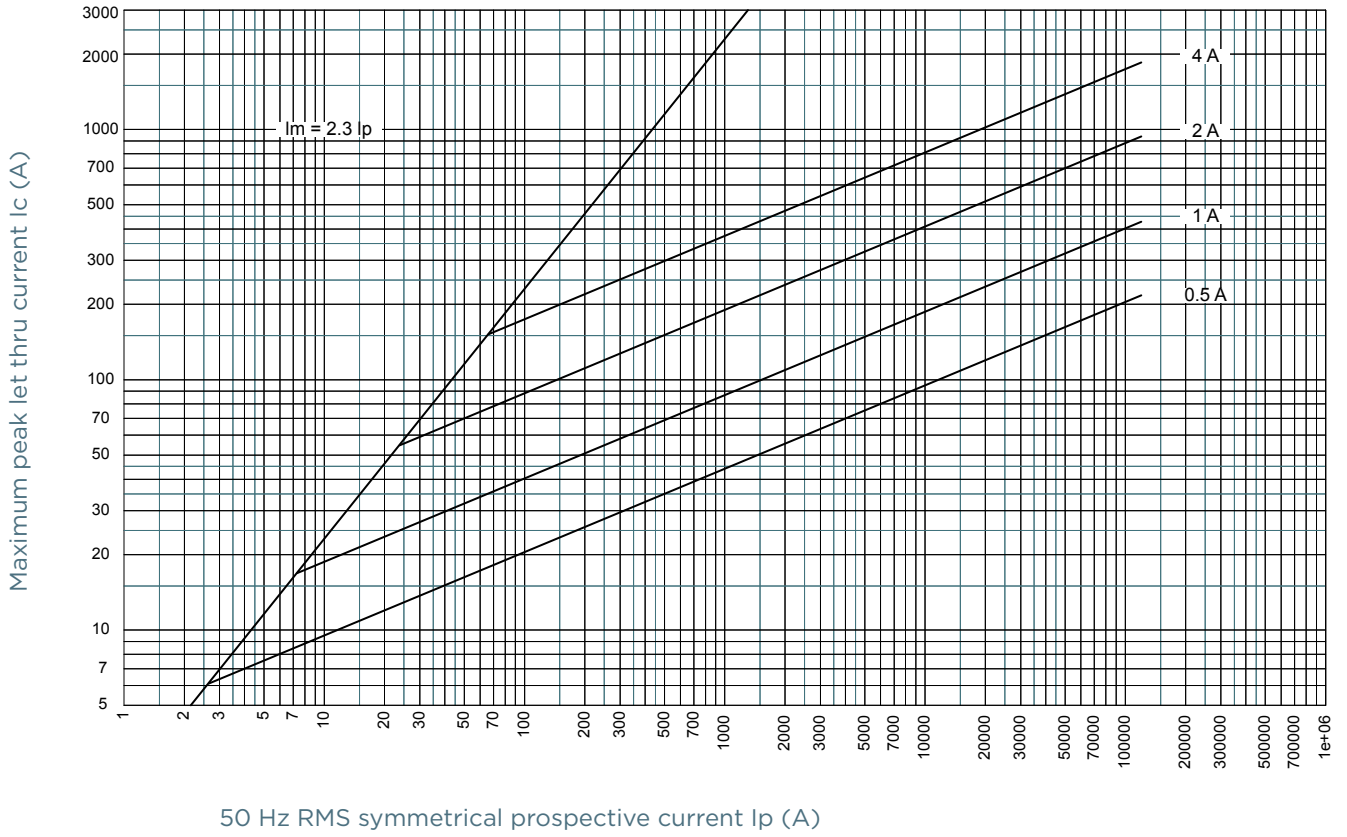

MERSEN reserves the right to change, update or correct, without notice, any information contained in this datasheet.

Ferrule fuse-links 10x38 gG 400 to 690VAC

CUT-OFF CURRENT CHARACTERISTIC

Size 10x38 500V gG without striker

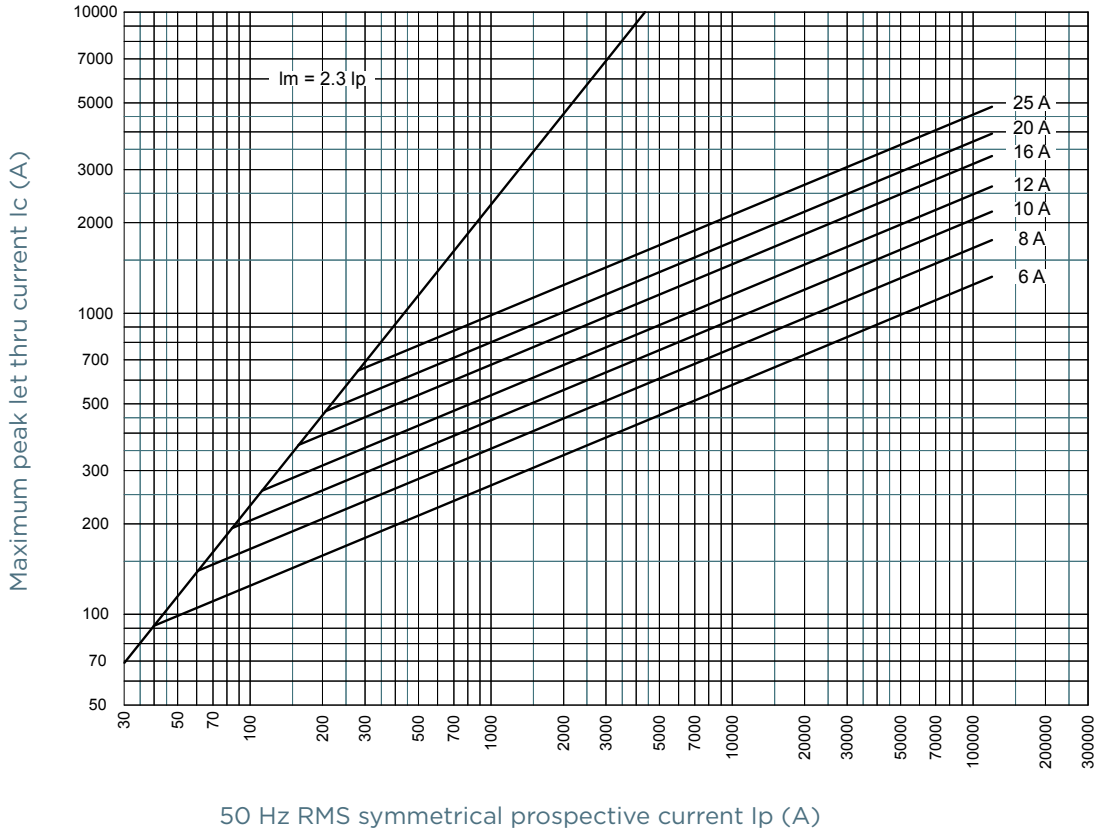

Size 10x38 400V gG without striker

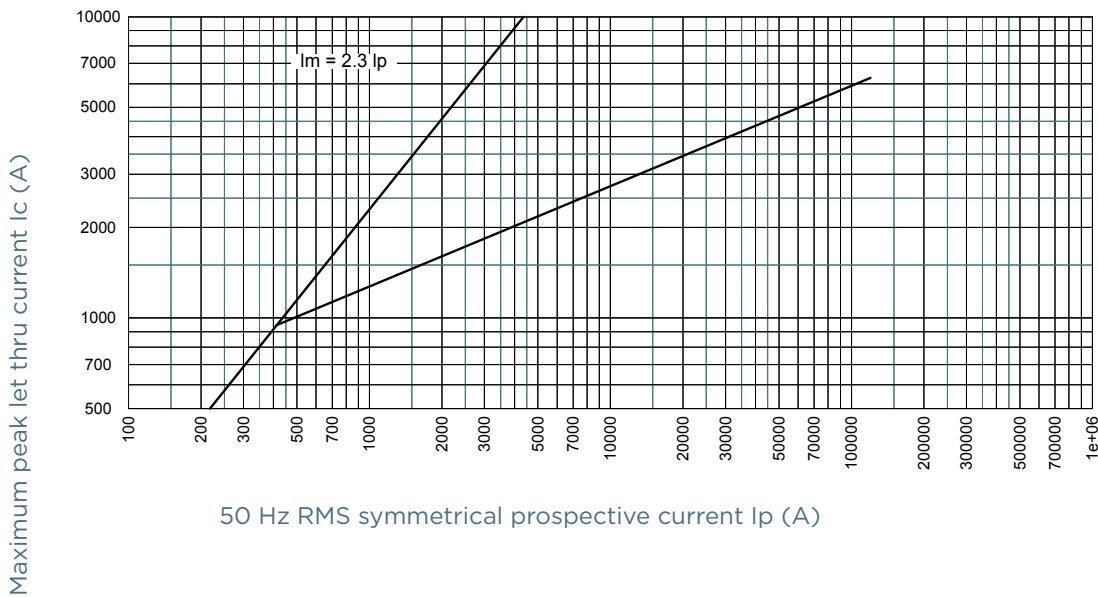

MERSEN reserves the right to change, update or correct, without notice, any information contained in this datasheet.

Ferrule fuse-links 10x38 gG 400 to 690VAC

CUT-OFF CURRENT CHARACTERISTIC

Size 10x38 690V gG without striker

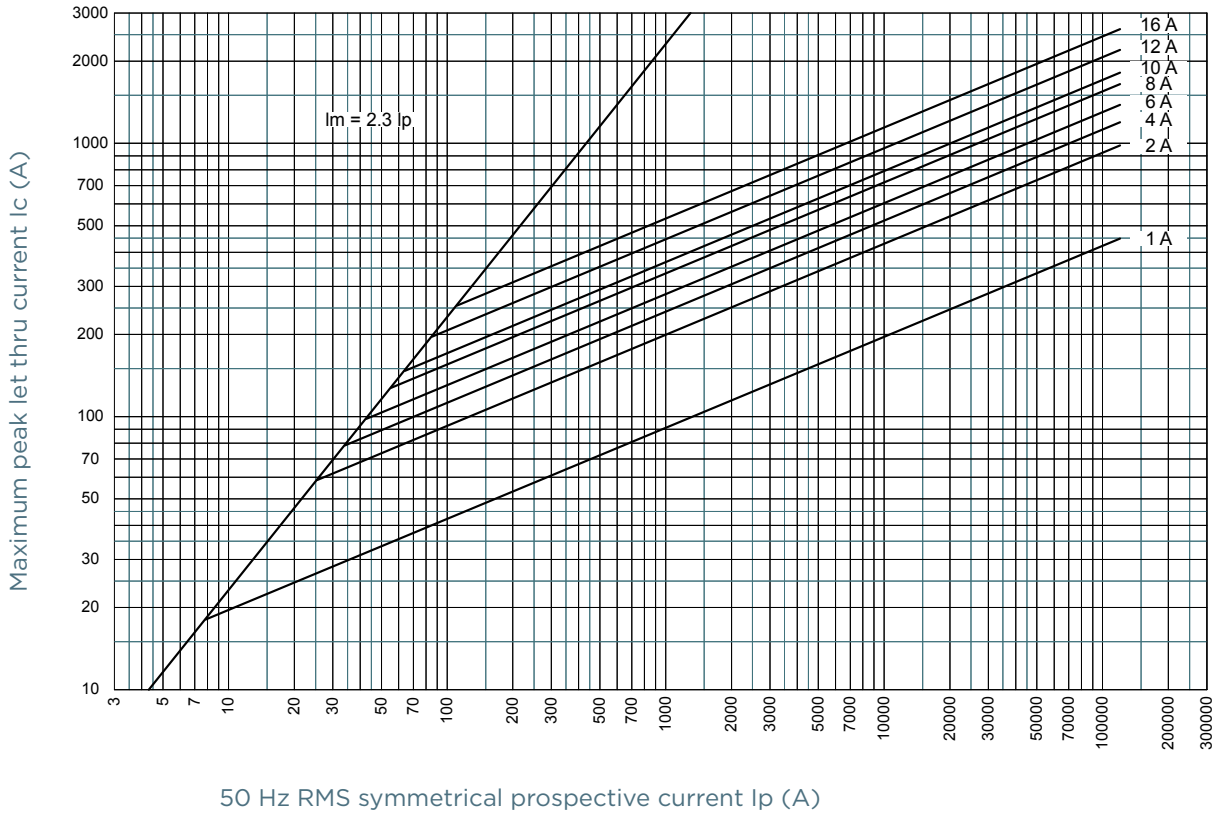

MERSEN reserves the right to change, update or correct, without notice, any information contained in this datasheet.

Ferrule fuse-links 10x38 gG 400 to 690VAC

CUT-OFF CURRENT CHARACTERISTIC

Size 10x38 400V gG with striker

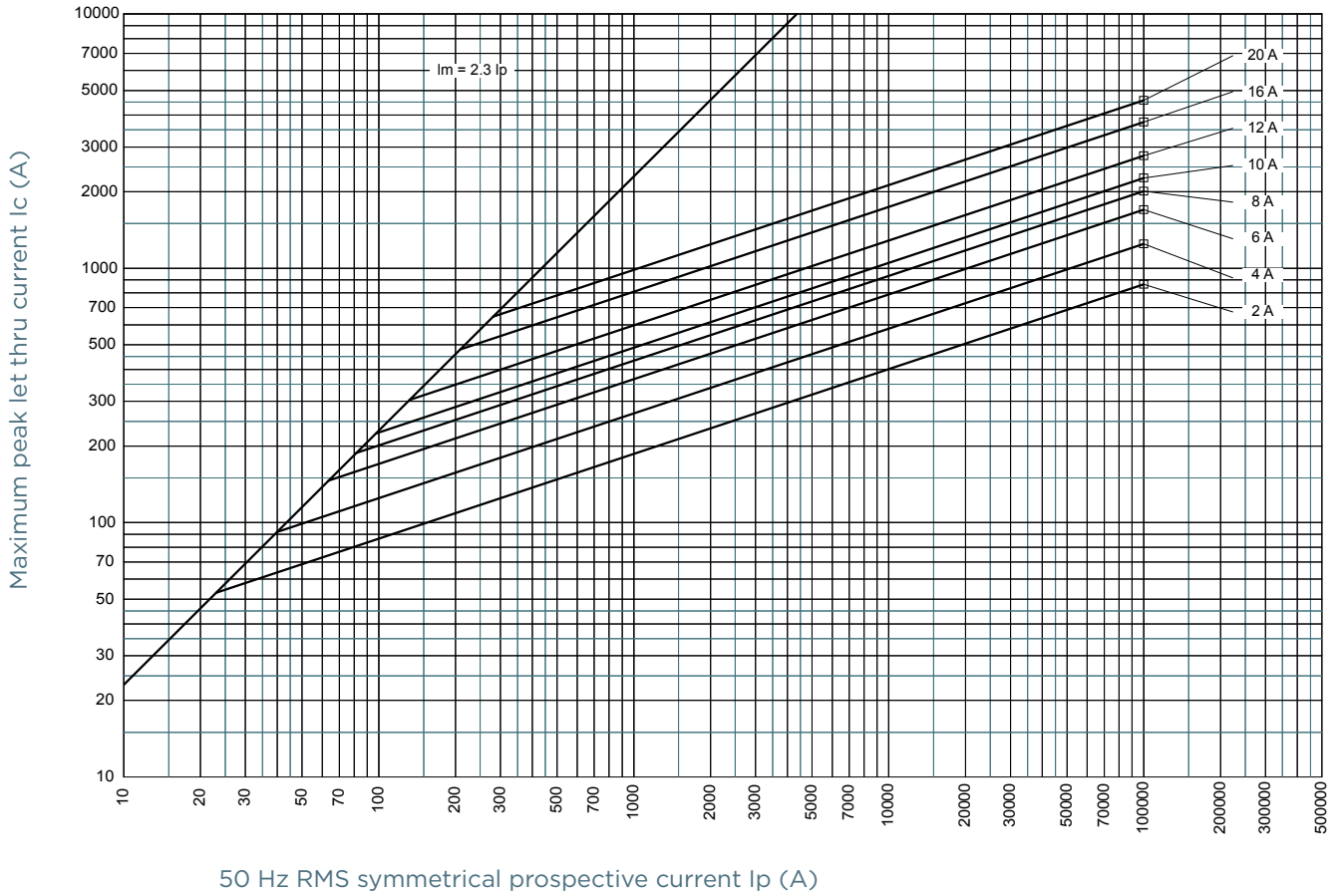

MERSEN reserves the right to change, update or correct, without notice, any information contained in this datasheet.

Ferrule fuse-links 10x38 gG 400 to 690VAC

CUT-OFF CURRENT CHARACTERISTIC

Size 10x38 250V gG with striker

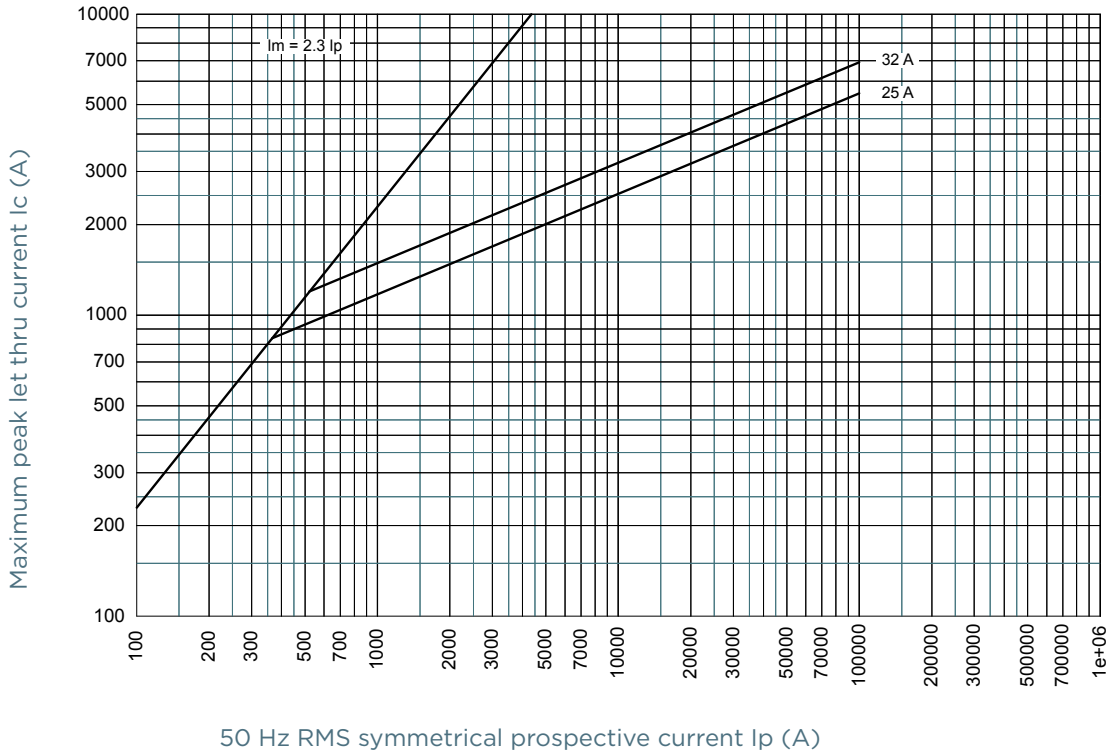

MERSEN reserves the right to change, update or correct, without notice, any information contained in this datasheet.

Ferrule fuse-links 10x38 gG 400 to 690VAC

PRE-ARCING AND OPERATING I²t CHARACTERISTICS

Size 10x38 500V gG without striker

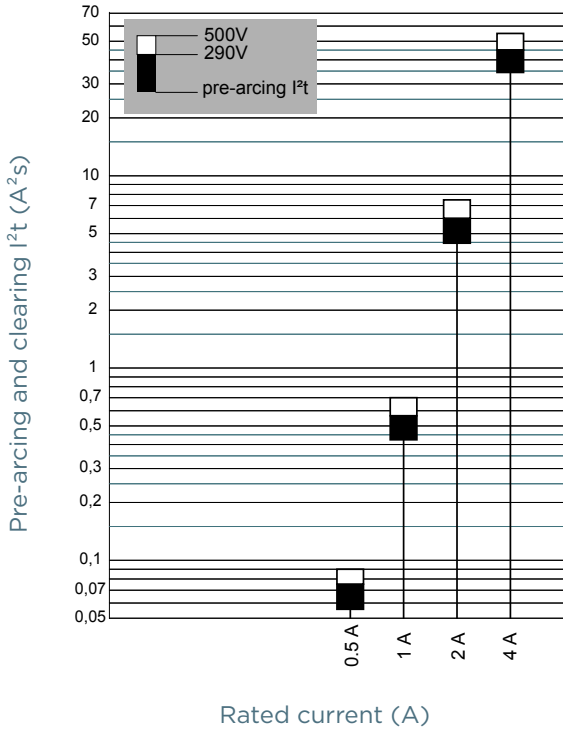

Size 10x38 500V gG without striker

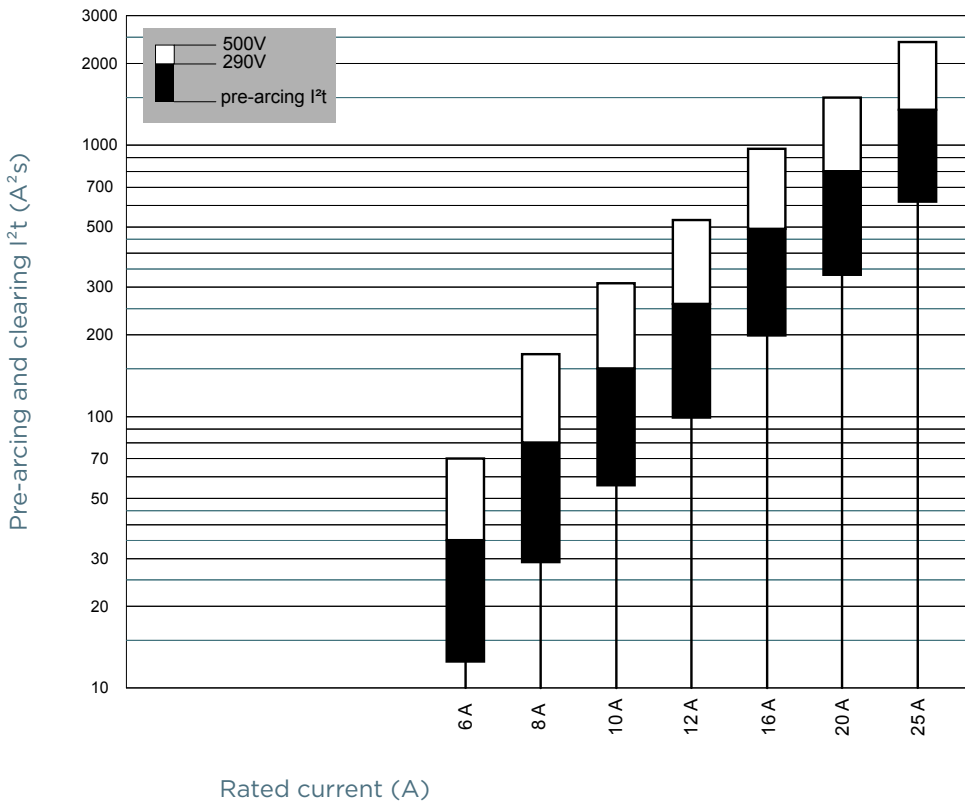

MERSEN reserves the right to change, update or correct, without notice, any information contained in this datasheet.

Ferrule fuse-links 10x38 gG 400 to 690VAC

PRE-ARCING AND OPERATING I²t CHARACTERISTICS

Size 10x38 400V gG without striker

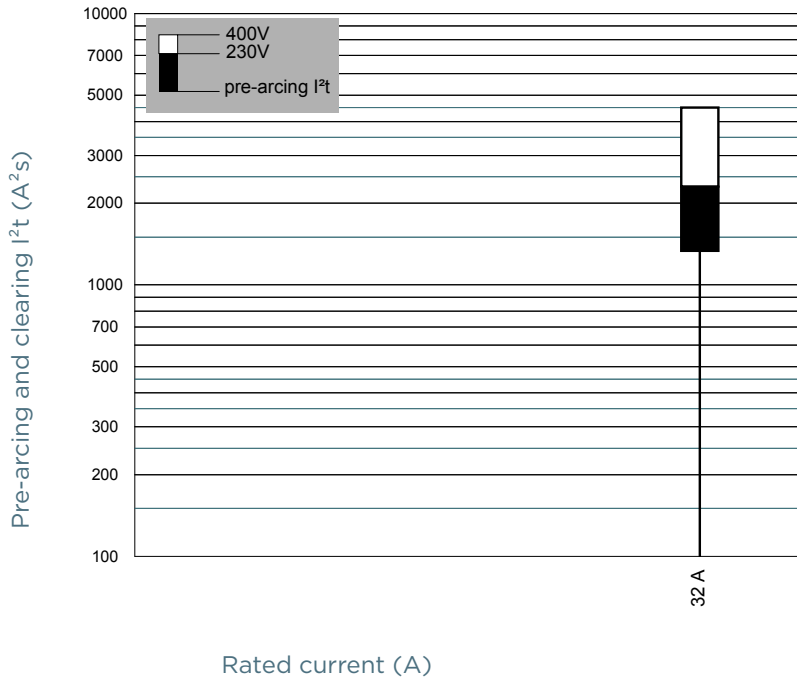

Size 10x38 690V gG without striker

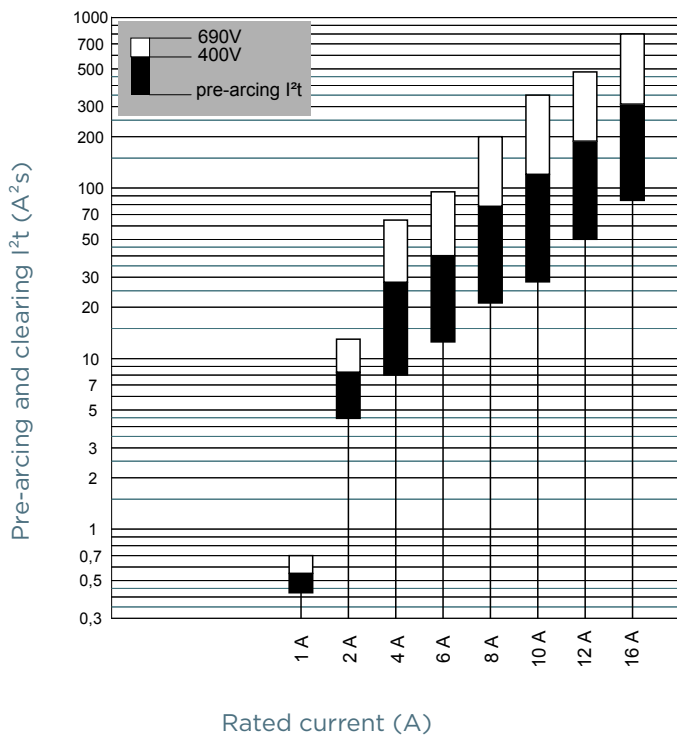

MERSEN reserves the right to change, update or correct, without notice, any information contained in this datasheet.

Ferrule fuse-links 10x38 gG 400 to 690VAC

PRE-ARCING AND OPERATING I²t CHARACTERISTICS

Size 10x38 400V gG with striker

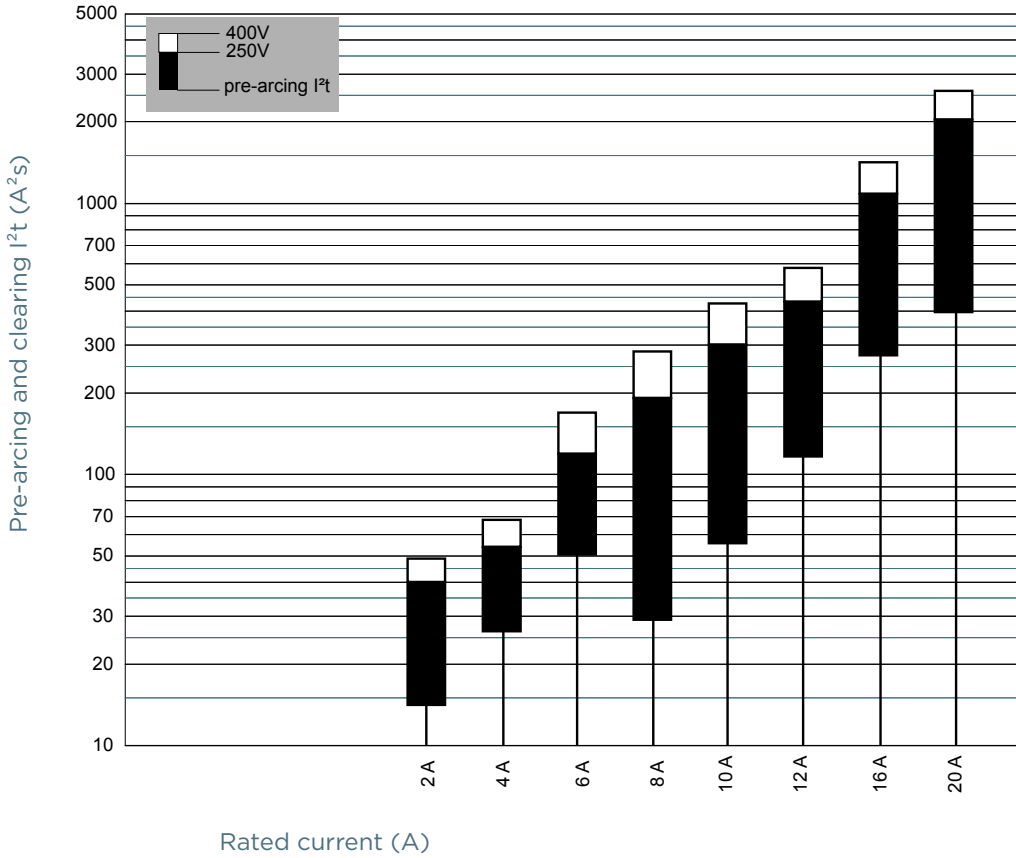

Size 10x38 250V gG with striker

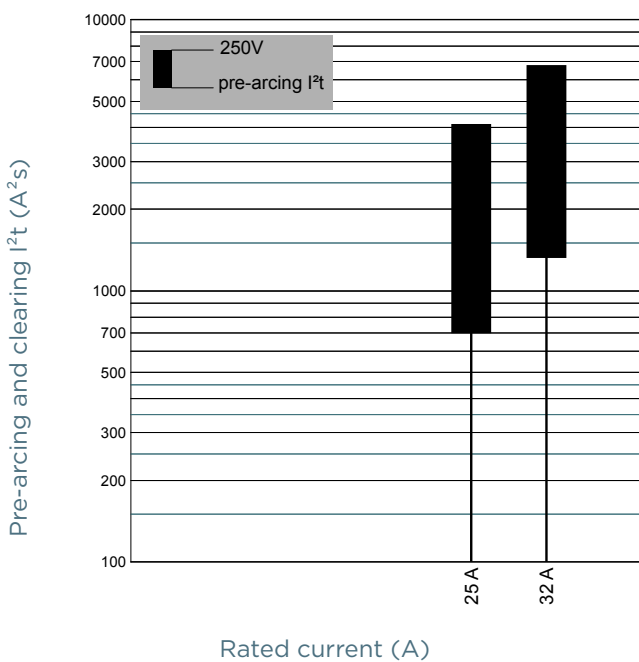

MERSEN reserves the right to change, update or correct, without notice, any information contained in this datasheet.

Ferrule fuse-links 10x38 gG 400 to 690VAC

DIMENSIONS

Size 10x38 gG without indicator (1001210)

Size 10x38 gG with indicator (1002537)

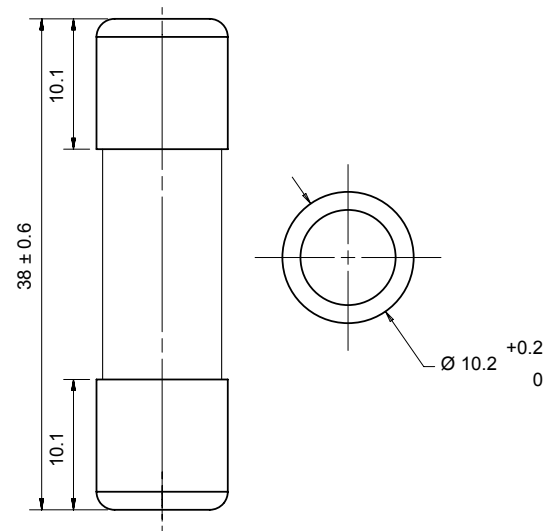

Dimensions in mm

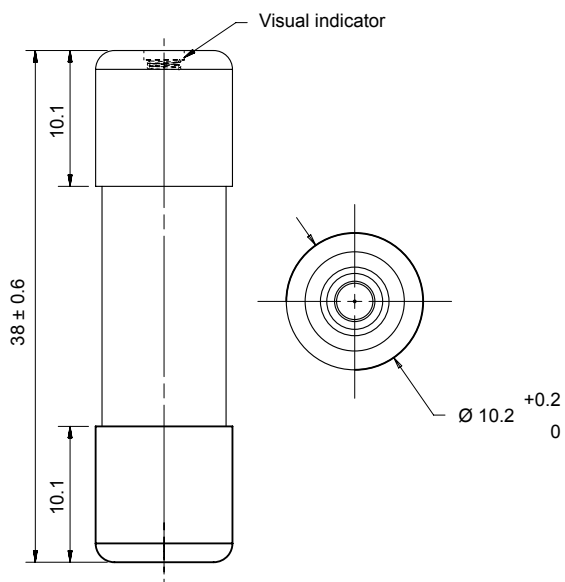

Dimensions in mm

Size 10x38 gG with striker (33907)

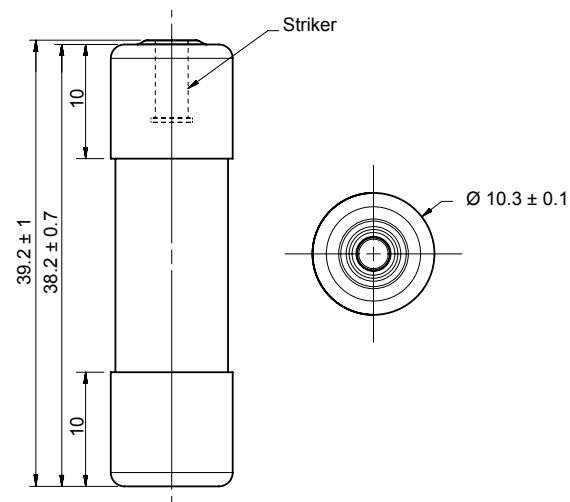

Dimensions in mm