



Main

Range of product	Harmony Relay
Series name	Interface relay
Product or component type	Plug-in relay
Device short name	RXG
Contacts type and composition	2 C/O

Complementary

Status LED	Without
Contacts material	Silver alloy (AgSnO ₂ In ₂ O ₃)
Maximum contact resistance	100 mOhm
[I _{th} e] conventional enclosed thermal current	5 A
[I _e] rated operational current	5 A 30 V DC) UL 5 A 30 V DC) IEC 5 A 250 V AC) IEC 5 A 250 V AC) UL
Maximum switching voltage	250 V
Load current	5 A
Maximum switching capacity	1250 VA AC 150 W DC
Minimum switching capacity	50 mW 10 mA, 5 V DC
Operating rate	<= 1800 cycles/hour under load <= 18000 cycles/hour no-load
Utilisation coefficient	20 %
Mechanical durability	10000000 cycles
Electrical durability	100000 cycles resistive
[U _i] rated insulation voltage	250 V IEC
[U _{imp}] rated impulse withstand voltage	6 kV 1.2/50 µs between coil and contact 4 kV 1.2/50 µs between poles 1.2 kV 1.2/50 µs between contacts 2.5 kV 1.2/50 µs between terminals and LTB area 1.5 kV 1.2/50 µs between terminals and base
Dielectric strength	1000 V AC between contacts micro disconnection 1300 V between terminals and base basic insulation 3000 V between terminals and LTB area basic insulation 3000 V AC between poles basic insulation 5000 V AC between coil and contact reinforced insulation
Coil resistance	1100 Ohm +/- 10 %
Insulation resistance	1000 MOhm 500 V DC
Test levels	Level A group mounting
Mounting position	Any position
Average coil consumption	0.53 W DC
Drop-out voltage threshold	>= 0.1 U _c DC
Coil insulation class	Class F
Operate time	20 ms

Release time	20 ms
[Uc] control circuit voltage	24 V DC
Safety reliability data	B10d = 100000
Colour of cover	Transparent
Control type	Lockable test button
Torque value	7.08 Lbf.in (0.8 N.m) 7.0 lbf.in (0.79 N.m)
Connections - terminals	Connector, 1 x 0.25...1 x 2.5 mm ² AWG 22...AWG 14) flexible with cable end Connector, 2 x 0.25...2 x 1 mm ² AWG 22...AWG 17) flexible with cable end Connector, 1 x 0.5...1 x 2.5 mm ² AWG 20...AWG 14) solid without cable end Connector, 2 x 0.5...2 x 1.5 mm ² AWG 20...AWG 16) solid without cable end
Net Weight	0.14 lb(US) (0.065 kg)
Device presentation	Complete product

Environment

Vibration resistance	3 gn +/- 1.5 mm 10...150 Hz)in operation 5 gn +/- 1.5 mm 10...150 Hz)not in operation
IP degree of protection	IP20
Shock resistance	20 gn in operation 100 gn not in operation
Protection category	RT I
Standards	IEC 61810-1 CSA C22.2 No 14 UL 508 IEC 61984
Product certifications	EAC RoHS CSA UL CE
Pollution degree	2
Overvoltage category	III
Ambient air temperature for storage	-40...185 °F (-40...85 °C)
Ambient air temperature for operation	-40...158 °F (-40...70 °C)
Relative humidity	10...85 %

Ordering and shipping details

Category	21127 - ZELIO ICE CUBE RELAYS
Discount Schedule	CP2
GTIN	03606489562854
Nbr. of units in pkg.	1
Package weight(Lbs)	1 lb(US) (0.45 kg)
Returnability	No

Packing Units

Package 1 Height	3.13 in (79.600 mm)
Package 1 width	0.61 in (15.600 mm)
Package 1 Length	2.83 in (72.000 mm)

Offer Sustainability

Sustainable offer status	Green Premium product
California proposition 65	WARNING: This product can expose you to chemicals including: Nickel compounds, which is known to the State of California to cause cancer, and Di-isodecyl phthalate (DIDP), which is known to the State of California to cause birth defects or other reproductive harm. For more information go to www.P65Warnings.ca.gov
REAcH free of SVHC	Yes
EU RoHS Directive	Pro-active compliance (Product out of EU RoHS legal scope)  EU RoHS Declaration
Toxic heavy metal free	Yes

Mercury free	Yes
RoHS exemption information	Yes
China RoHS Regulation	China RoHS Declaration
Environmental Disclosure	Product Environmental Profile
WEEE	The product must be disposed on European Union markets following specific waste collection and never end up in rubbish bins.

Contractual warranty

Warranty	18 months
----------	-----------

Dimensions

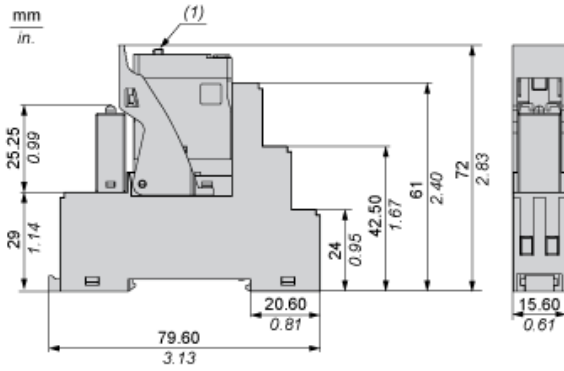

(1) Push button (if any)

Wiring Diagram

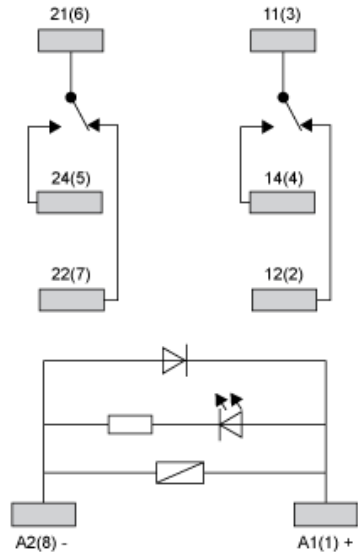

NOTE: For DC input , A1 have to be + , otherwise it would short circuit from protection module

Performance Curves

Maximum Switching Capacity

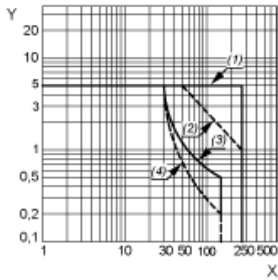

- X : Switching voltage (V)
- Y : Switching current (A)
- (1) AC Resistive Load
- (2) AC Inductive Load $\cos(\phi)=0.4$
- (3) DC Resistive Load
- (4) DC Inductive Load ($L/R=7\text{ms}$)

Life Expectancy

Resistive Load

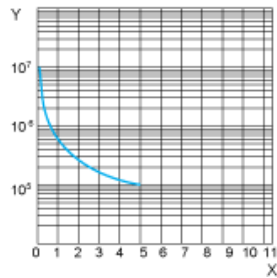

- X : Contact Current (A)
- Y : Operating Cycle Number

Life Expectancy

Inductive Load

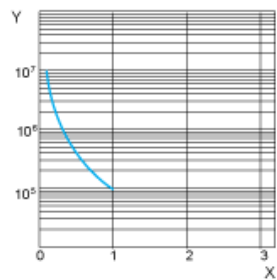

- X : Contact Current (A)
- Y : Operating Cycle Number

NOTE: These are typical curves, actual durability depends on load, environment, duty cycle, etc.

Coil Operating Range

DC Coil Operating Range VS Ambient Temperature

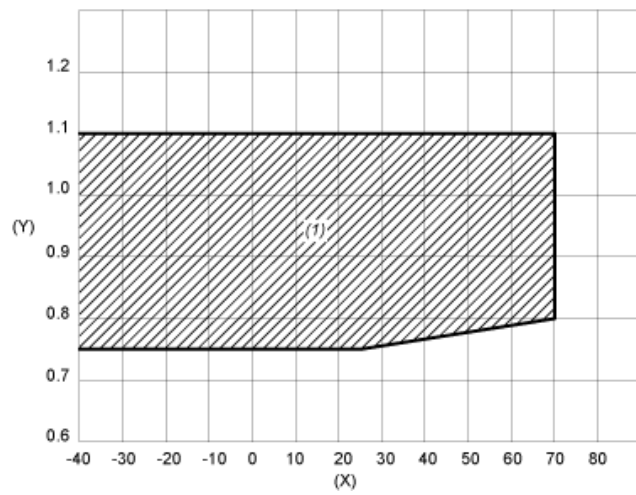

X : Ambient temperature (°C)

Y : Coil voltage (U/Uc)

(1) Permitted operating range area