

# C RTP Series Non-lighted Double-pole Rocker Switches

## Approvals

UL recognized, CSA certified. Load rating: 20A 125/250 VAC. 1 HP, 125/250 VAC. 14A 14VDC, VDE approval 15A. Contacts: fine silver for long life dependability. Dielectric strength: 1250 volts (live parts to ground). Life: 35,000 operations at maximum rating. Insulation resistance: 5 megohms.

## Low Level Control

For low level/dry circuit applications (<100 am) contact factory for part number (Gold plated contacts).

## High Inrush

125 Amp inrush capability (AgNi contacts). Positive action on/off available.

## Terminals

Style A - 1/4-inch quick-connect

## Mechanical Features









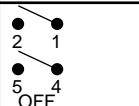

100,000 mechanical operations

## Markings

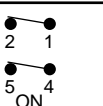
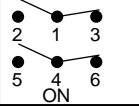
Letters, numbers and symbols can be applied to rocker actuator or to integral nylon bezel; see inside back cover for details.

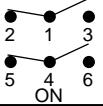
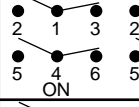
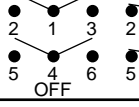
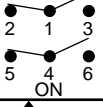
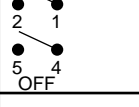
## Mounting

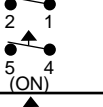
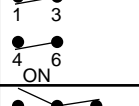
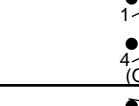
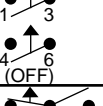
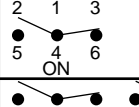
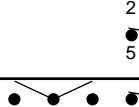
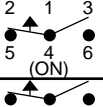
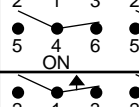
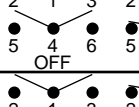
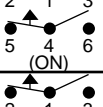
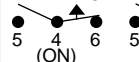
Snap-in type panel mounting for ease of installation without additional mounting hardware.

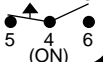
Circuit	Switching			
11	DPST Maintained			
22	DPDT Maintained			
33	DPDT Maintained Center Off			
44	DPST (Momentary) Normally Open			
55	DPDT (Momentary) Normally Closed			
66	DPDT (Momentary) Transfer			
77	DPDT Maintained Center Off (Momentary)			
88	DPDT (Momentary) Center Off (Momentary)			

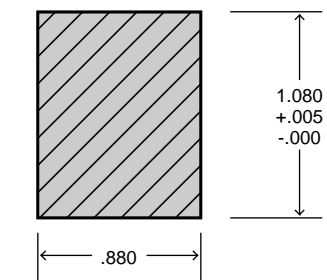
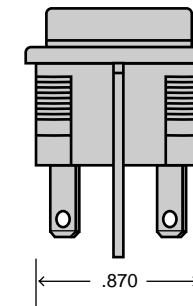
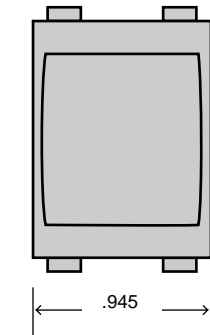
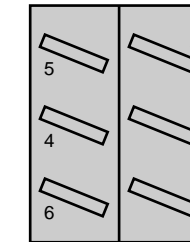
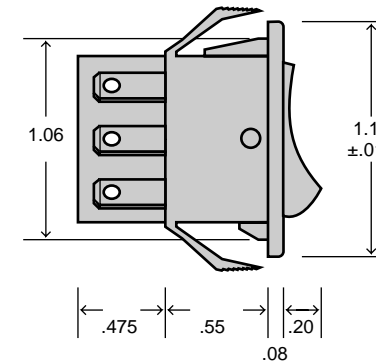

Panel Cut Out  
Panel Thickness 1/32" - 3/16"

## Ordering Information:

