

**Power PCB Relay RT1 Inrush Power**

- 1 pole 16 A, 1 NO contact (W pre-make contact + AgSnO<sub>2</sub>)
- 10 A / 250 VAC making and breaking capacity acc. to IEC 60669-1
- 165 A / 20 ms inrush peak current
- Mono- or bistable coil
- 5 kV / 10 mm coil-contact
- Reinforced insulation
- Optional test tab (manual operator)
- RoHS compliant (Directive 2002/95/EC)

**Applications**

Lighting systems, movement sensors, filament and incandescent lamp loads, motors



F0272-A

**Approvals**

VDE REG.-Nr. 6106, cULus E214025, cULus 14385  
 Technical data of approved types on request

Contact data	RT.3T	RTS3L
Contact configuration	1 NO	
Contact set	pre-make contact	single contact
Type of interruption	micro disconnection	
Rated current	16 A	
Rated voltage / max. switching voltage AC	250/400 VAC	
Limiting continuous current	16 A	
Maximum breaking capacity AC	4000 VA	
Limiting making capacity		
max 20 ms (incandescent lamps)	165 A	120 A
max 200 µs (fluorescent lamps)	800 A	-
Contact material	W (pre-make cont.)+AgSnO <sub>2</sub>	AgSnO <sub>2</sub>
Mechanical endurance DC	> 5x10 <sup>6</sup> cycles	> 10x10 <sup>6</sup> cycles
bistable	> 3x10 <sup>6</sup> cycles	> 5x10 <sup>6</sup> cycles
tab manually operated	> 10 <sup>3</sup> cycles	-
Rated frequency of operation with / without load	6 / 60 min <sup>-1</sup>	

**Contact ratings**

Type	Load	Cycles
RTS3T	3000 W, 230 VAC, DF 8,3%, 5 min <sup>-1</sup> , incandescent lamp	typ. 12x10 <sup>3</sup>
RT*3T	16 A, 250 VAC, capacitive load 140 µF, 7,5 min <sup>-1</sup> , EN60669-1	> 20x10 <sup>3</sup>
RT*3T	TV5, UL508, 40°C	25x10 <sup>3</sup>
RTS3L	16 A, 250 VAC, 85°C	> 100x10 <sup>3</sup>
RTS3L	1.5 hp, 240 VAC	
RTS3L	TV8, UL508, 40°C	25x10 <sup>3</sup>
RTS3L	10/100 A / 250 VAC, simulated lamp load, acc. to IEC 61810-2	20x10 <sup>3</sup>

**Coil data**

**Coil data, monostable coil**

Rated coil voltage range	5...110 VDC
Coil power	typ 400 mW
Operative range	2
Coil insulation system according UL1446	class F

**Coil versions, monostable DC-coil**

Coil code	Rated voltage VDC	Operate voltage VDC	Release voltage VDC	Coil resistance Ω	Rated coil power mW
005	5	3.5	0.5	62±10%	403
006	6	4.2	0.6	90±10%	400
012	12	8.4	1.2	360±10%	400
024	24	16.8	2.4	1440±10%	400
048	48	33.6	4.8	5520±10%	417
060	60	42.0	6.0	8570±12%	420
110	110	77.0	11.0	28800±12%	420

All figures are given for coil without preenergization, at ambient temperature +23°C  
 Other coil voltages on request

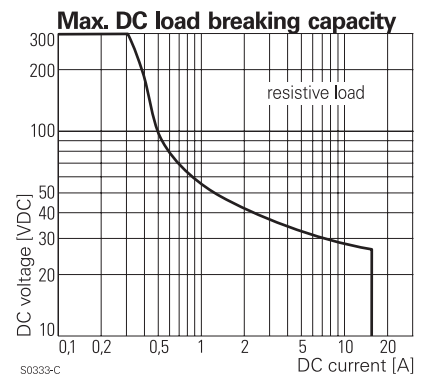

S0333-C

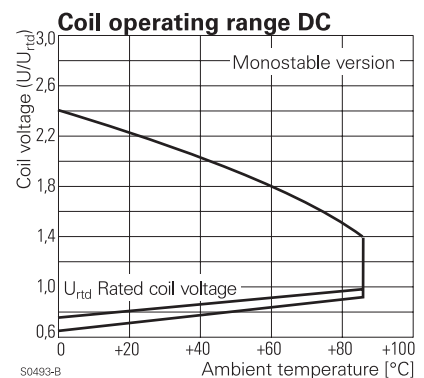

S0493-B

**Power PCB Relay RT1 Inrush Power (Continued)**

Coil data, bistable coils	1 coil	2 coils
Rated coil voltage range	3...24 VDC	
Coil power	typ 400 mW	typ 600 mW
Operative range	2	
Limiting voltage, % of rated coil voltage	120%	150%
Minimum energization duration	30 ms	
Maximum energization duration	1 min at < 10% DF	
Coil insulation system according UL1446	class F	

Coil versions, bistable 1 coil					
Coil code	Rated voltage VDC	Operate voltage VDC	Reset voltage VDC	Coil resistance Ω	Rated coil power mW
A03	3	2.1	1.7	21±10%	429
A12	12	8.4	6.6	360±10%	400
A24	24	16.8	13.2	1440±10%	400

Coil versions, bistable 2 coils					
Coil code	Rated voltage VDC	Operate voltage VDC	Reset voltage VDC	Coil resistance Ω	Rated coil power mW
F03	3	2.1	1.7	15±10%	600
F12	12	8.4	6.6	240±10%	600
F24	24	16.8	13.2	886±10%	650

All figures are given for coil without preenergization, at ambient temperature +23°C  
Other coil voltages on request

**Coils - operation**

Version	1 coil		2 coils		
Coil terminals	A1	A2	A1	A3	A2
Pull-in	+	-	+	-	-
Reset	-	+	-	+	-

Contact position not defined at delivery

**Insulation**

Dielectric strength coil-contact circuit	5000 V <sub>rms</sub>	
open contact circuit	1250 V <sub>rms</sub>	
Clearance / creepage coil-contact circuit	≥ 10 / 10 mm	
Material group of insulation parts	≥ IIIa	
Tracking index of relay base	PTI 250 V	
Insulation to IEC 60664-1		
Type of insulation coil-contact circuit	reinforced	
open contact circuit	functional	
Rated insulation voltage	250 V	
Pollution degree	3	2
Rated voltage system	240 V	400 V
Overvoltage category	III	

Other data	RT.3T	RTS3L
RoHS - Directive 2002/95/EC	compliant	
Flammability class according to UL94	V-0	
Ambient temperature range	monostable -40...+70°C	-40...+85°C
bistable: 1 coil	-10...+70°C	-10...+85°C
bistable: 2 coils	-40...+70°C	-40...+85°C
Vibration resistance (function) monostable	10 g	20 g
Shock resistance (destruction)	100 g	
Category of protection	RTII - flux proof	
Mounting	pcb or on socket*)	
Mounting distance	0 mm	
Resistance to soldering heat	270 °C / 10 s	
Relay weight with / without test tab	16 / 14 g	- / 14 g
Packaging unit with / without test tab	100 / 500 pcs	- / 500 pcs

\*) RTT3T or bistable 2 coil version, pcb mounting only; see Accessories

**Accessories RTS3.**

For details see datasheet	Accessories Power Relay RT
---------------------------	----------------------------

**Coil operating range, 1 coil**

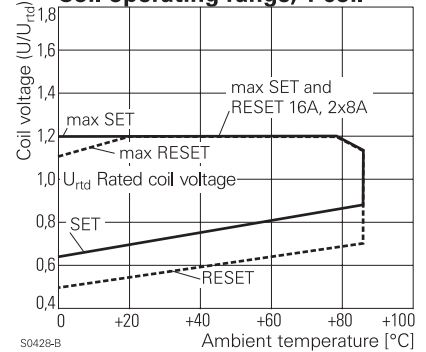

**Coil operating range, 2 coils**

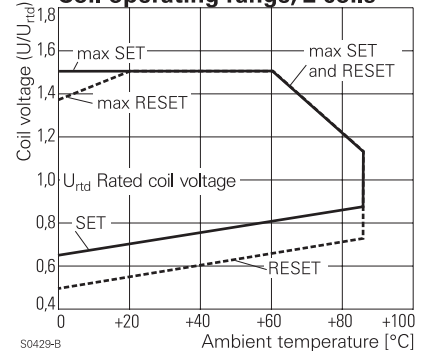

**Terminal assignment**

Bottom view on solder pins

monostable version

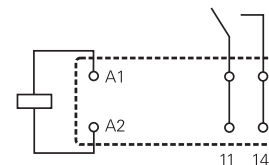

S0163-BF

bistable version

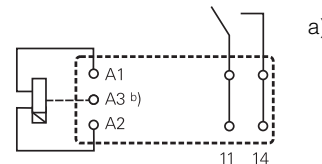

S0163-CS

a) Indicated contact position during or after coil energization with reset voltage.

b) for 2 coil version only

**Power PCB Relay RT1 Inrush Power (Continued)**

**Dimensions / PCB layout**

version without test tab

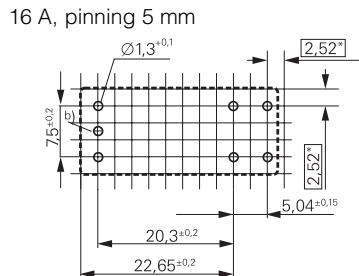
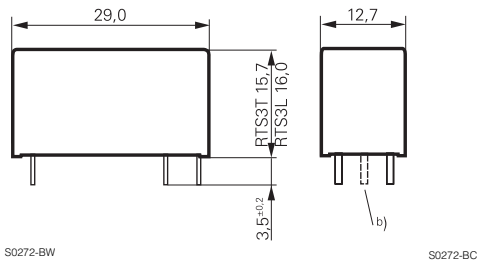

S0418-CV b) for 2 coil version only

version with test tab



\*) With the recommended PCB hole sizes a grid pattern from 2.5 mm to 2.54 mm can be used.

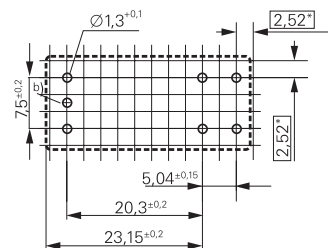
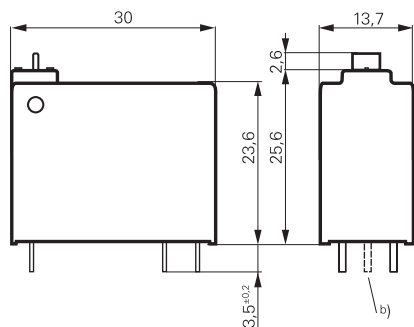

S0492-CU

**Product key**

Type	<b>R</b>	<b>T</b>		<b>3</b>			
Version	<b>S</b> without test tab		<b>T</b> with test tab (manual operator) for contact material 'T' and bistable coil only				
Contact configuration	<b>3</b> 1 NO contact						
Contact material	<b>L</b> AgSnO <sub>2</sub>		<b>T</b> Tungsten (W) pre-make + AgSnO <sub>2</sub>				
Coil	Coil code: please refer to coil versions table						

**Power PCB Relay RT1 Inrush Power (Continued)**

Product key	Version	Contacts	Cont. material	Coil	Coil	Part number
RTS3L005	without	1 NO contact	AgSnO <sub>2</sub>	monostable	5 VDC	1-1415898-8
RTS3L012	test tab			coil	12 VDC	1-1415898-9
RTS3L018					18 VDC	2-1415898-0
RTS3L024					24 VDC	1-1415898-4
RTS3L048					48 VDC	2-1415898-1
RTS3L060					60 VDC	2-1415898-2
RTS3LA12				bistable	12 VDC	2-1415898-3
RTS3LA24				1-coil	24 VDC	2-1415898-4
RTS3LF12				bistable	12 VDC	2-1415898-5
RTS3LF24				2-coils	24 VDC	2-1415898-6
RTS3T012			W pre-make +	monostable	12 VDC	0-1415898-0
RTS3T024			AgSnO <sub>2</sub>	coil	24 VDC	0-1415898-1
RTS3TA12				bistable	12 VDC	0-1415898-2
RTS3TA24				1-coil	24 VDC	0-1415898-3
RTS3TF03				bistable	3 VDC	0-1415898-4
RTS3TF12				2-coils	12 VDC	0-1415898-5
RTS3TF24					24 VDC	0-1415898-6
RTT3TA12	with			bistable	12 VDC	0-1415898-7
RTT3TA24	test tab			1-coil	24 VDC	0-1415898-8
RTT3TF12				bistable	12 VDC	0-1415898-9
RTT3TF24				2-coils	24 VDC	1-1415898-0