



www.r-theta.com

STANDARD

Products Catalog



ISO 9001 - 2000 REGISTERED

R-Theta Thermal Solutions Inc.

has been a global leader for over 25 years in the design and manufacturing of innovative thermal management solutions serving a broad range of markets. Major markets include telecommunications, computers, industrial controls, power conversion, transportation, medical, alternative energy and aerospace.

R-Theta's powerful software "R-Tools" provides on-line thermal modeling of heat sinks for semiconductors in natural or forced convection for air cooled, as well as, liquid-cooled cold plates. The interface is friendly, with only minimal parameters needed to be specified. Users can register free on-line for R-Tools on the R-Theta web site www.r-theta.com.

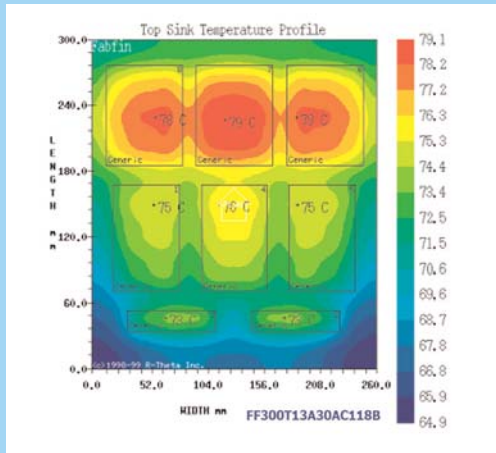

Standard products offered in this catalog are Heat Sinks for board level IC's, Surface Mount and Thru-Hole Discrete semiconductor packages, Extruded heat sinks, Fabfin and Aluminum Extrusion profiles. Thermal interface materials include silicone and non-silicone Thermal Compounds, Sil-Pads and Adhesive tapes.

R-theta also offers a complete line of high performance patented, aluminum alloy heat sinks without the use of glue and are available through R-Theta's extensive line. The company has developed leading edge heat sink technology that eliminates volumetric constraints of one-piece extrusions. By mechanically swaging the parts together there is no deterioration in performance compared to a solid block of aluminum. R-Theta heat sinks mean greater thermal design flexibility by offering the same co-efficient of thermal expansion for the entire heat sink. R-Theta heat sinks allow you to maximize heat cooling by pushing the thermal envelope for greater productivity.

Call and ask for your copy of the Navigator 1-800-388-5428 or check us out on the web at www.r-theta.com

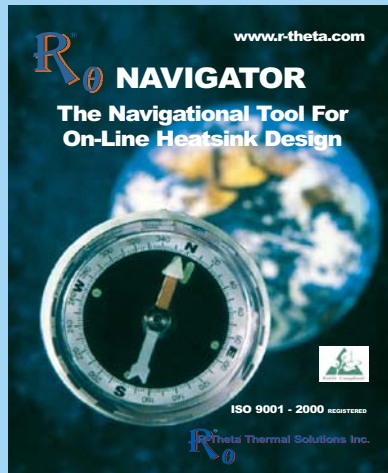



Table of Contents

Heat sinks for IC Packages (Integrated Circuit)

Board Level Heat Sinks

BGA	Pgs.	2 - 4
DIP	Pg.	4

Surface Mount Discrete Semiconductor Packages

D-PAK TO-252, TO-263, TO-268	Pg.	5
------------------------------	-----	---

Thru-Hole Discrete Semiconductor Packages

TO-220 and TO-262	Pgs.	6 - 7
TO-220 and TO-202	Pgs.	8 - 11
TO-220, TO-218, TO-247 and Multiwatt	Pgs.	12 - 13

Extruded Heat Sinks for DC/DC Converters & Solid State Relays

High Power Semiconductor Packages

DC/DC converter Full-Brick	Pg.	14
DC/DC converter Half-Brick	Pg.	15
Solid State Relays (Fabfin)	Pg.	16

Fabfin Heat Sinks for IGBT and High Power Devices

Mechanically Bonded (Swaged) Heat Sinks	Pg.	17
---	-----	----

Polar Interface Materials



Thermal compound (silicone)	Pg.	18
Thermal compound (non-silicone)	Pg.	19
Sil-Pads	Pg.	20
Adhesive Tapes	Pg.	21

Aluminum Extrusion Profiles

Extrusion characteristics table	Pg.	22
Extrusion Profiles	Pg.	23

Index by Device Cooled

Pg.	24
-----	----

Index By Part Number

Pg.	25
-----	----



R-theta Thermal Solutions Inc. believes that information provided in this product catalog is accurate as of publication date. Product testing for proper performance in customer applications is recommended for all component designs. The physical properties reported herein are representative of performance values obtained by standard predictive and testing methods. R-Theta is a manufacturer of heat dissipation products and reserves the right to make changes to its products without notice to improve the design of performance characteristics.

Cat#600220

Omnidirectional Pin Fin Heat Sink for 21 mm BGAs

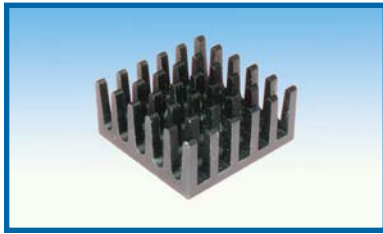

The omnidirectional pin fin heat sink is available in four standard heights. Add pressure sensitive adhesive tape for easy and reliable attachment to IC package. See page 21 for adhesive tapes.

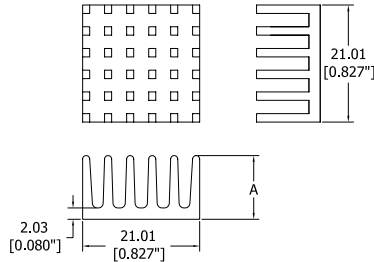

Aluminum, Black Anodized

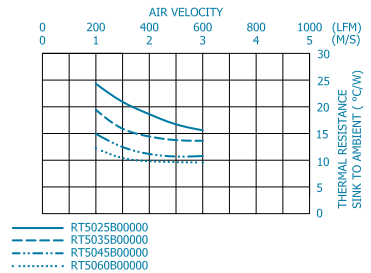

Part Number	Base Dimensions mm (in.) Sq.	Height "A" mm (In.)
RT5025B00000	21 (.827)	6.4 (.250)
RT5035B00000	21 (.827)	8.9 (.350)
RT5045B00000	21 (.827)	11.4 (.450)
RT5060B00000	21 (.827)	15.2 (.600)

Omnidirectional Pin Fin Heat Sink for 25 mm BGAs



The omnidirectional pin fin heat sink is available in four standard heights. Add pressure sensitive adhesive tape for easy and reliable attachment to IC package. See page 21 for adhesive tapes.

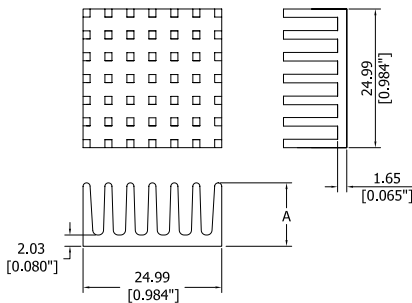

Aluminum, Black Anodized

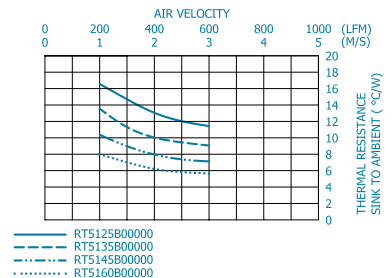

Part Number	Base Dimensions mm (in.) Sq.	Height "A" mm (In.)
RT5125B00000	25 (.984)	6.4 (.250)
RT5135B00000	25 (.984)	8.9 (.350)
RT5145B00000	25 (.984)	11.4 (.450)
RT5160B00000	25 (.984)	15.2 (.600)

Omnidirectional Pin Fin Heat Sink for 28 mm BGAs

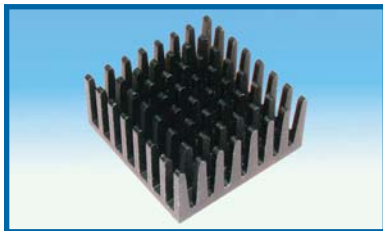

The omnidirectional pin fin heat sink is available in four standard heights. Add pressure sensitive adhesive tape for easy and reliable attachment to IC package. See page 21 for adhesive tapes.

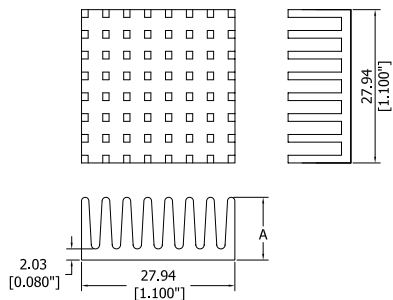

Aluminum, Black Anodized

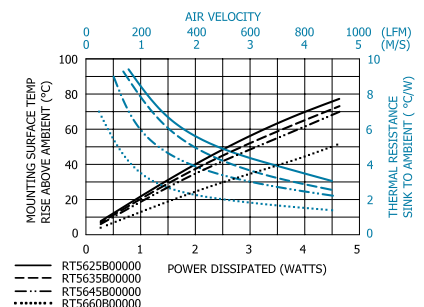

Part Number	Base Dimensions mm (in.) Sq.	Height "A" mm (In.)
RT5625B00000	27.9 (1.100)	6.4 (.250)
RT5635B00000	27.9 (1.100)	8.9 (.350)
RT5645B00000	27.9 (1.100)	11.4 (.450)
RT5660B00000	27.9 (1.100)	15.2 (.600)

Omnidirectional Pin Fin Heat Sink for 35 mm BGAs

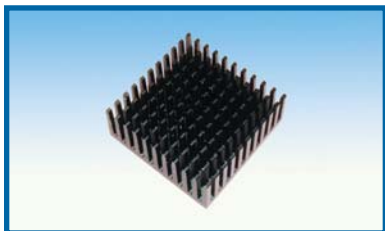

The omnidirectional pin fin heat sink is available in four standard heights. Add pressure sensitive adhesive tape for easy and reliable attachment to IC package. See page 21 for adhesive tapes.

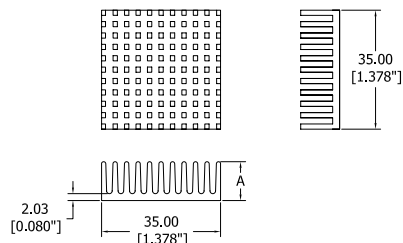

Aluminum, Black Anodized

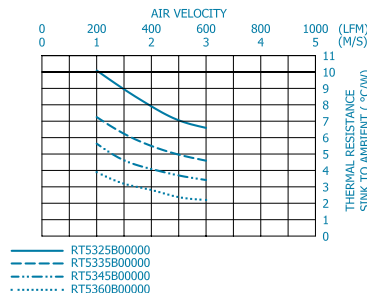

Part Number	Base Dimensions mm (in. Sq)	Height "A" mm (In.)
RT5325B00000	35 (1.378)	6.4 (.250)
RT5335B00000	35 (1.378)	8.9 (.350)
RT5345B00000	35 (1.378)	11.4 (.450)
RT5360B00000	35 (1.378)	15.2 (.600)

Omnidirectional Pin Fin Heat Sink for 40 mm BGAs

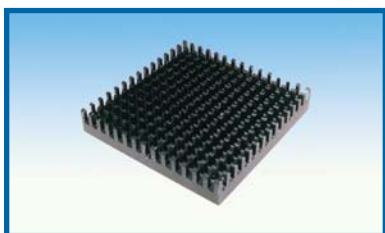

The omnidirectional pin fin heat sink is available in four standard heights. Add pressure sensitive adhesive tape for easy and reliable attachment to IC package. See page 21 for adhesive tapes.

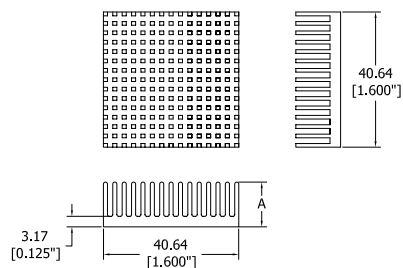

Aluminum, Black Anodized

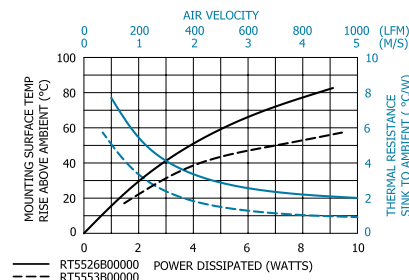

Part Number	Base Dimensions mm (in. Sq)	Height "A" mm (In.)
RT5526B00000	40.6 (1.600)	6.6 (.260)
RT5553B00000	40.6 (1.600)	13.3 (.525)

Omnidirectional Pin Fin Heat Sink for 45 mm BGAs

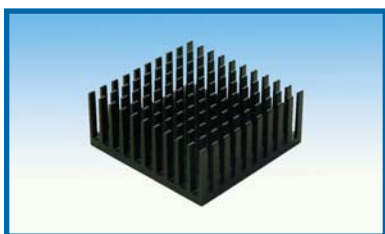

The omnidirectional pin fin heat sink is available in three standard heights. Add pressure sensitive adhesive tape for easy and reliable attachment to IC package. See page 21 for adhesive tapes.

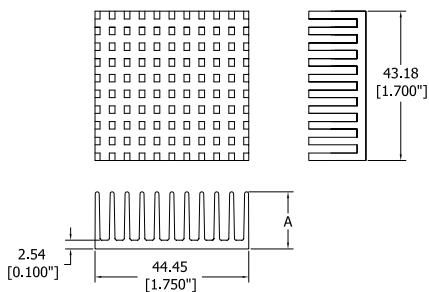

Aluminum, Black Anodized

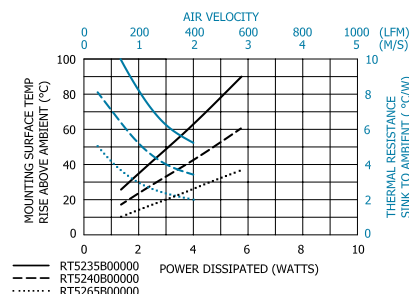

Part Number	Base Dimensions mm (in. Sq)	Height "A" mm (In.)
RT5235B00000	44.5 (1.750) X 43.2 (1.700)	8.9 (.350)
RT5240B00000	44.5 (1.750) X 43.2 (1.700)	10.2 (.400)
RT5265B00000	44.5 (1.750) X 43.2 (1.700)	16.5 (.650)



Unidirectional Fin Heat Sink for 35 mm BGAs

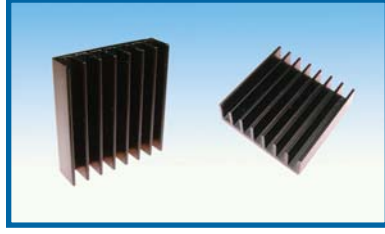

The omnidirectional pin fin heat sink is available in four standard heights. Add pressure sensitive adhesive tape for easy and reliable attachment to IC package. See page 21 for adhesive tapes.

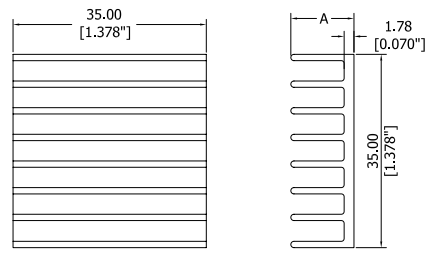

Aluminum, Black Anodized

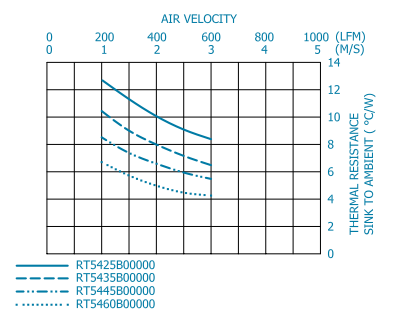

Part Number	Base Dimensions mm(in. Sq)	Height "A" mm (In.)
RT5425B00000	35 (1.378)	6.4 (.250)
RT5435B00000	35 (1.378)	8.9 (.350)
RT5445B00000	35 (1.378)	11.4 (.450)
RT5460B00000	35 (1.378)	15.2 (.600)

Unidirectional epoxy attach heat sink for 14 and 16 pin dip packages



Unidirectional epoxy attach fin to heat sink attaches to 14 and 16 pin DIP packages quickly and easily. May be added before or after final board assembly, no additional board space is required. Available in two fin directions.

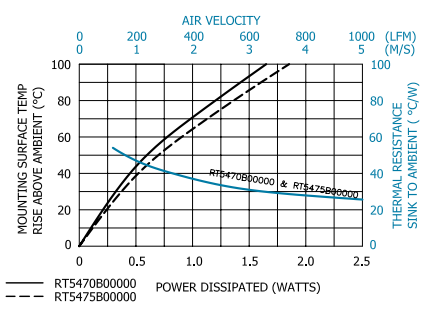

Part Number
RT5470B00000
RT5475B00000

RT5470B00000

RT5475B00000

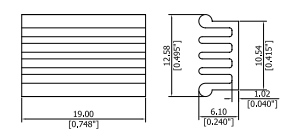
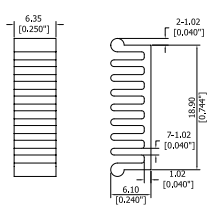

Aluminum, Black Anodized

Surface mount heat sink for D-PAK (TO-252) package semiconductors



Surface mount heat sink for D-PAK (TO-252) package semiconductors remove the heat indirectly without contacting the device like traditional thru hole heat sinks. The device and the heat sink are soldered directly to a modified drain pad creating a thermal transfer path from package tab to the heat sink.

Part Number
RT1750D00000

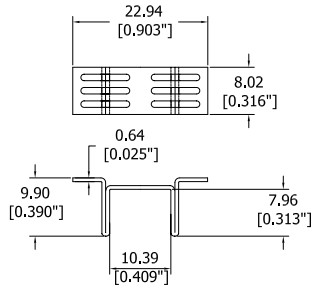

0.64 (0.025) Thick Copper, Tin Plated

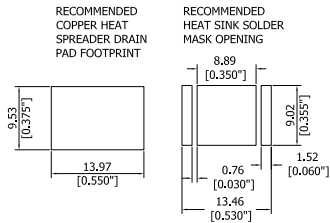
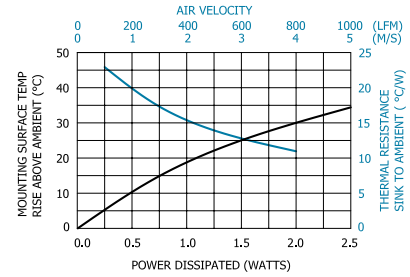

Surface mount heat sink for D²-PAK (TO-263) package semiconductors



Surface mount heat sink for D²-PAK (TO-263) package semiconductors remove the heat indirectly without contacting the device like traditional thru hole heat sinks. The device and the heat sink are soldered directly to a modified drain pad creating a thermal transfer path from package tab to the heat sink.

Part Number
RT1755D00000

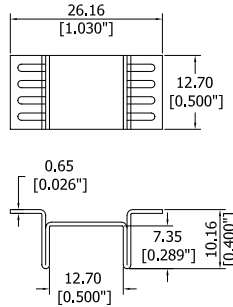

0.65 (0.026) Thick Copper, Tin Plated

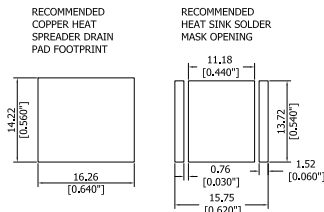
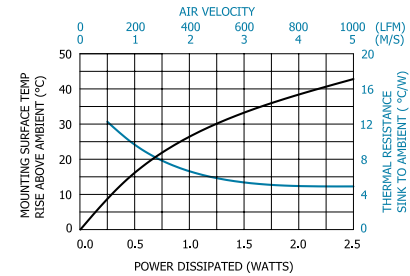

Surface mount heat sink for D³-PAK (TO-268) package semiconductors



Surface mount heat sink for D³-PAK (TO-268) package semiconductors remove the heat indirectly without contacting the device like traditional thru hole heat sinks. The device and the heat sink are soldered directly to a modified drain pad creating a thermal transfer path from package tab to the heat sink.

Part Number
RT1760D00000

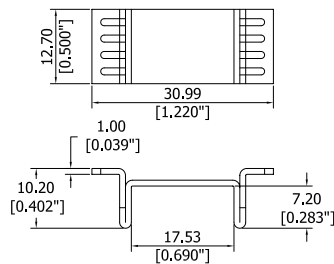

1.00 (0.039) Thick Copper, Tin Plated

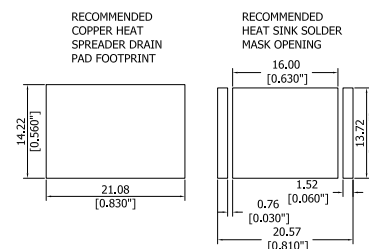
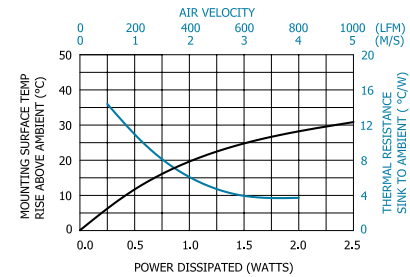



Plug In style heat sink with two self-locking clips for TO-220 & TO-262



Plug in style heat sink with two self locking clips and mounting hole to firmly hold the device to the heat sink ensuring maximum metal to metal thermal contact. Available with solderable mounting tabs for both horizontal and vertical mounting to the PC board.

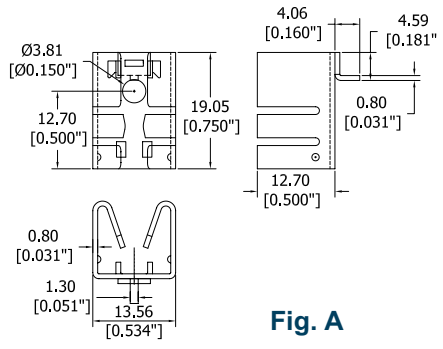

Fig. A

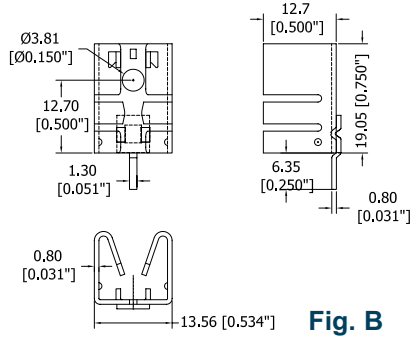
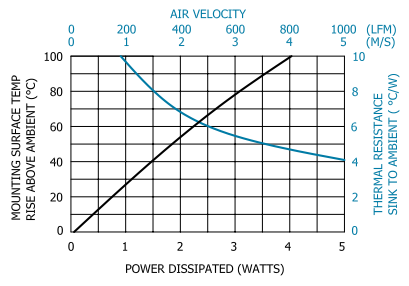

Fig. B

Aluminum, Black Anodized

Part Number	Description	Fig.	Dia. of PCB Plated Thru hole for Tab
RT1000B00000	Slim plug in heat sink without tab	A	N/A
RT1000B03100	With single tab for horizontal mounting	A	1.75 (0.069)
RT1000B04000	With single tab for vertical mounting	B	1.75 (0.069)



Plug In style heat sink featuring four self-locking clips for TO-220 and TO-262



Plug in style heat sink features four self locking clips to firmly hold the device to the heat sink ensuring maximum metal to metal thermal contact. Available with solderable mounting tabs for both horizontal and vertical mounting to the PC board.

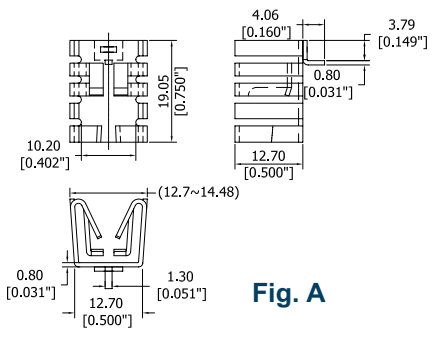

Fig. A

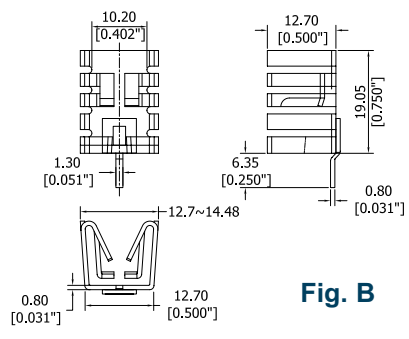
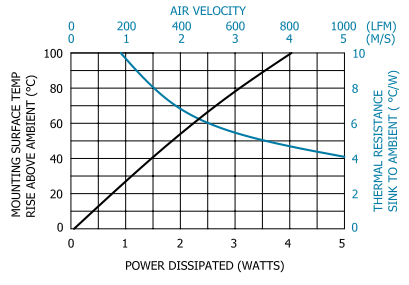

Fig. B

Aluminum, Black Anodized

Part Number	Description	Fig.	Dia. of PCB Plated Thru hole for Tab
RT1002B00000	Slim plug in heat sink without tab	A	N/A
RT1002B03100	With single tab for horizontal mounting	A	1.75 (0.069)
RT1002B04000	With single tab for vertical mounting	B	1.75 (0.069)





Plug In style heat sink featuring two self-locking clips for TO-220 & TO-262



Plug in style heat sink features two self locking clips to firmly hold the device to the heat sink ensuring maximum thermal contact. Available with solderable mounting tabs for both horizontal and vertical mounting to the PC board.

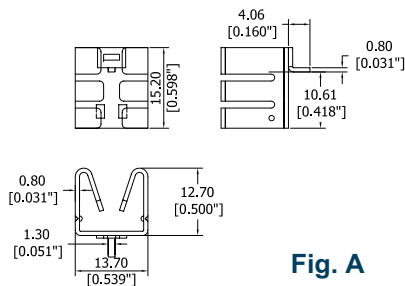

Fig. A

Aluminum, Black Anodized

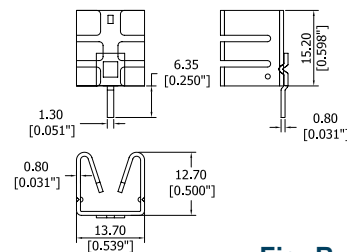
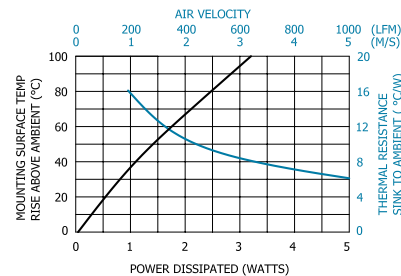

Fig. B

Part Number	Description	Fig.	Dia. of PCB Plated Thru hole for Tabs
RT1050B00000	Plug in style heat sink	A	N/A
RT1050B03100	With horizontal mounting tab	A	1.75 (0.069)
RT1050B04000	With vertical mounting tab	B	1.75 (0.069)



Channel style heat sink featuring twisted fins for TO-220



Channel style heat sink features twisted fins for increased air turbulence for better cooling. Includes three device mounting options, hole, slot or clip and wave solderable tin plated tabs for easy attachment to the PC board.

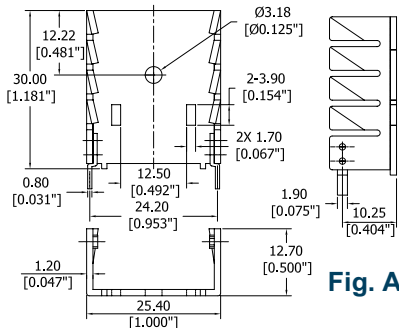

Fig. A

Aluminum, Black Anodized

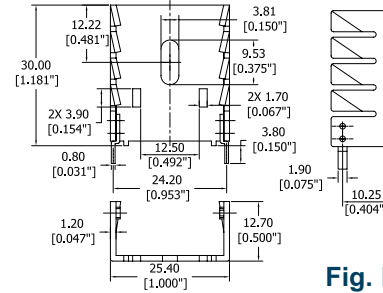
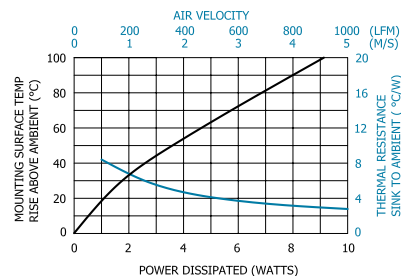

Fig. B

Part Number	Fig.	Mounting	Dia. of PCB Plated Thru hole for Tabs
RT1100B03400	A	Hole	2.36 (0.093)
RT1110B03400	B	Slot	2.36 (0.093)



Popular Option: Device Mounting Clip Part Number: RT1460U00000 (Order Separately)

Economy, narrow base, low profile channel style heat sink for TO-220



Economy, narrow base, low profile channel style heat sink is perfect for use on printed circuit boards with 0.500 inch centering. When mounted horizontally, the total height of the heat sink is just 9.65 (0.380).

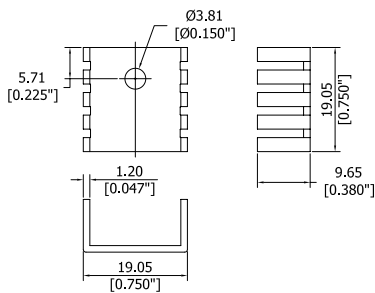

Aluminum, Black Anodized

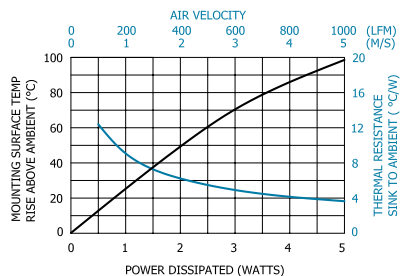

Part Number
RT1300B00000



Channel style heat sink with three integrated tabs for a variety of devices

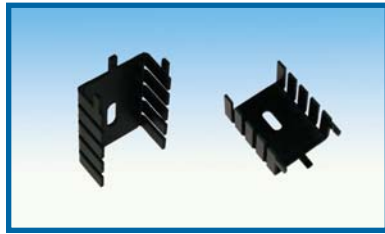

Channel style heat sink with three integrated tabs for greater stability and slotted mounting hole to accommodate a variety of device lead lengths. Mounting tabs are designed twisted to mount to PCB.

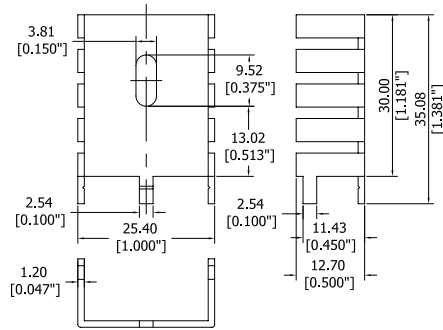

Aluminum, Black Anodized

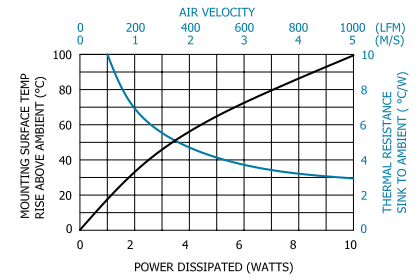

Part Number
RT1500B00000

Channel style heat sink featuring device mounting hole/slot for a variety of devices

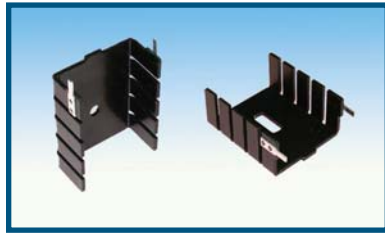

Channel style heat sink features device mounting hole or slot to accommodate a variety of device lead lengths. Mounting tabs are Tin Finish for soldering to PCB.

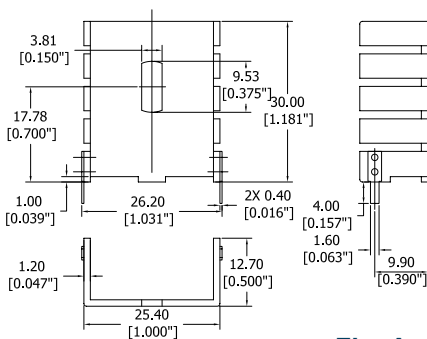

Fig. A

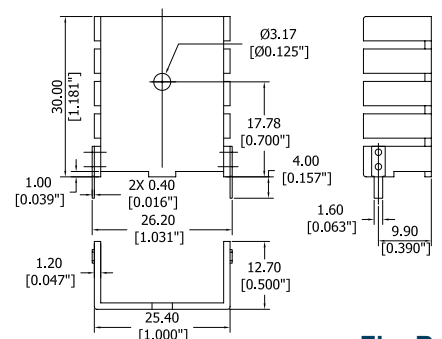
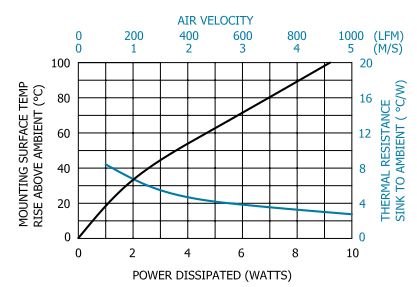

Fig. B

Aluminum, Black Anodized



Part Number	Fig.	Mounting	Dia. of PCB Plated Thru hole for Tabs
RT1550B03400	A	Slot	2.05 (0.081)
RT1560B03400	B	Hole	2.05 (0.081)

Thin profile space saving twisted fin heat sink for TO-220



Thin profile space savings twisted fin heat sink for vertical mounting TO-220 devices. Features staked on solderable mounting tabs for easy attachment to the PC board.

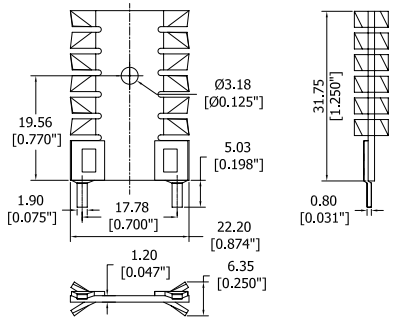

Aluminum, Black Anodized

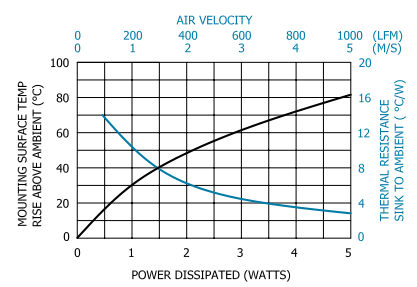

Part Number	Fig.	Dia. of PCB Plated Thru hole for Tabs
RT1600B03400	A	2.39 (0.094)



Lightweight, channel style heat sink featuring twisted fins for TO-220



Lightweight, channel style heat sink featuring twisted fins designed for mounting horizontally or vertically on a PC board.

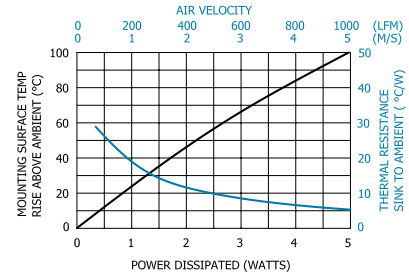
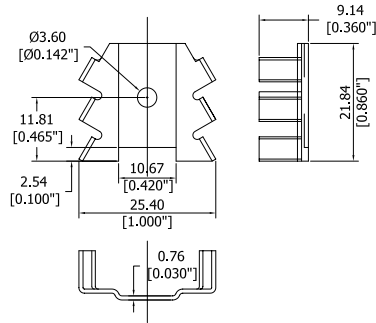

Part Number
RT1700B00000

Aluminum, Black Anodized

Hat section style heat sink for TO-220



Hat section style heat sinks are low profile and perfect for use on printed circuit cards with 0.500 inch centering between boards. For higher power application the RT1200 hat can be added to the RT1150 or RT1250 for double sided cooling of a TO-220 device.

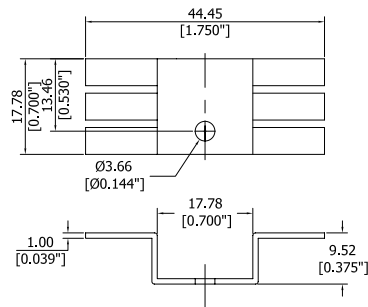

RT1150 - Figure A

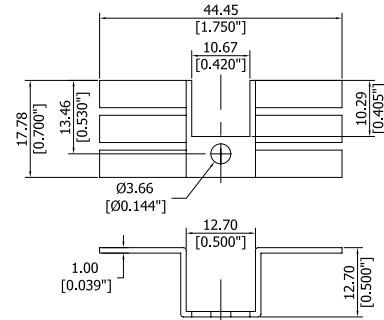

RT1200 - Figure B

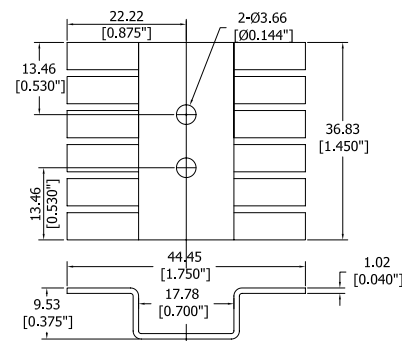

RT1250 - Figure C

Part Number	Description	Fig.
RT1150B00000	Wide hat section heat sink	A
RT1200B00000	Top mount hat heat sink with cut out	B
RT1250B00000	Dual Device hat section heat sink	C

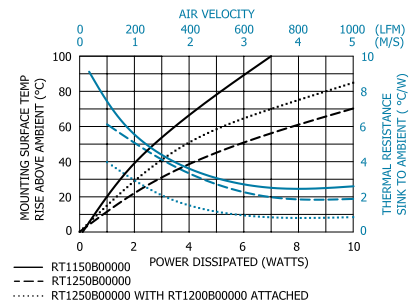

Aluminum, Black Anodized



Extruded heat sink with large radial fins for TO-202 and TO-220



Extruded heat sink with large radial fins features equal channel widths on both sides for single or dual device mounting. Includes two solderable mounting pins which permit vertical mounting and eliminate stress on device leads. Available in four heights for TO-202 and TO-220 devices.

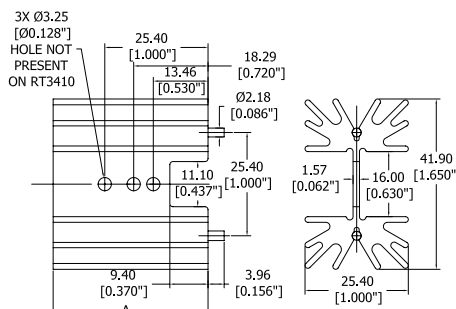

Aluminum, Black Anodized

Part Number	Device	"A" mm (In.)	Dia. of PCB Plated Thru hole for Tabs
RT3410B02500	TO-202, TO-220	24.50 (1.00)	2.67 (0.105)
RT3415B02500	TO-202, TO-220	38.20 (1.50)	2.67 (0.105)
RT3420B02500	TO-202, TO-220	50.80 (2.00)	2.67 (0.105)
RT3425B02500	TO-202, TO-220	63.50 (2.50)	2.67 (0.105)

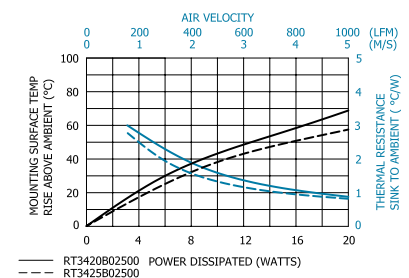
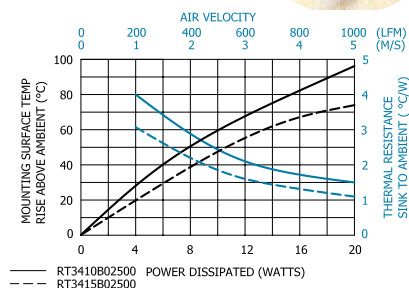

Compact low cost channel style heat sink for TO-220



Compact low cost channel style heat sink is ideal where space and cost are limited. Available in three fin heights with or without solderable mounting tab.

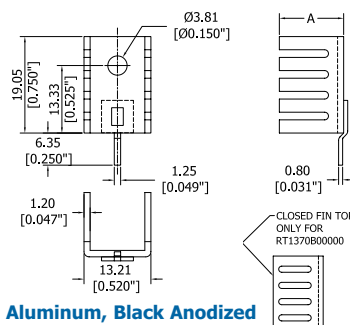

Aluminum, Black Anodized

Part Number	Description	"A" mm (In.)	Dia. of PCB Plated Thru hole for Tab
RT1350B00000	Slim, low cost channel style heat sink	6.35 (0.250)	N/A
RT1360B00000	Slim, low cost channel style heat sink	9.53 (0.375)	N/A
RT1360B04000	With solderable tab	9.53 (0.375)	1.73 (0.068)
RT1370B00000	Slim, low cost channel style heat sink	12.70 (0.500)	N/A
RT1370B04000	With solderable tab	12.70 (0.500)	1.73 (0.068)

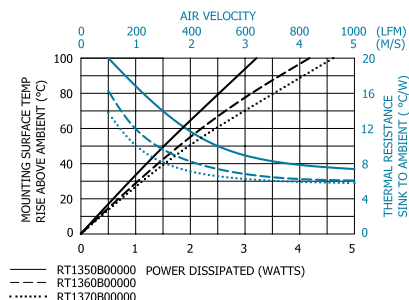

Compact low cost channel style heat sink for TO-202



Compact low cost channel style heat sink is notched to accommodate the TO-202 center tab packages. Available in two fin heights.

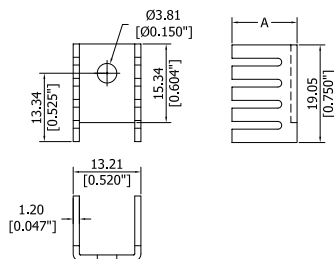

Aluminum, Black Anodized

Part Number	"A" mm (In.)
RT1400B00000	9.53 (0.375)
RT1410B00000	12.70 (0.500)

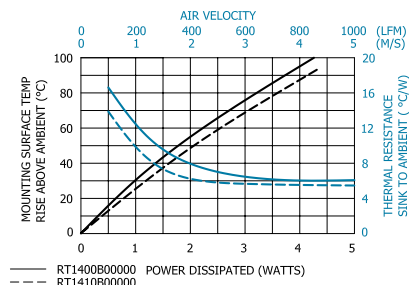



Extruded heat sink with radial fins and notched base for TO-202 and TO-220



Extruded heat sink with radial fins and notched base features equal channel widths on both sides for single or dual device mounting. Includes two solderable mounting pins which permit vertical mounting and eliminate stress on device leads. Available in four heights for TO-202 and TO-220 devices.

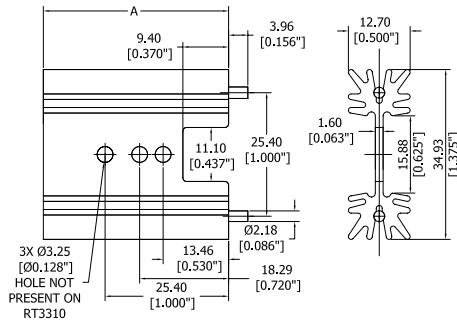

Aluminum, Black Anodized

Part Number	Device	"A" mm (In.)	Dia. of PCB Plated Thru hole for Tabs
RT3310B02500	TO-202, TO-220	24.50 (1.00)	2.67 (0.105)
RT3315B02500	TO-202, TO-220	38.20 (1.50)	2.67 (0.105)
RT3320B02500	TO-202, TO-220	50.80 (2.00)	2.67 (0.105)
RT3325B02500	TO-202, TO-220	63.50 (2.50)	2.67 (0.105)

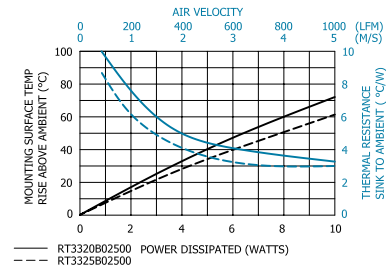
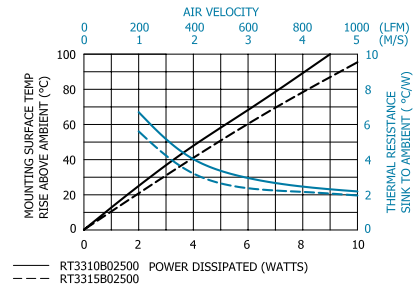

Channel style heat sink with wide mounting surface for a variety of devices

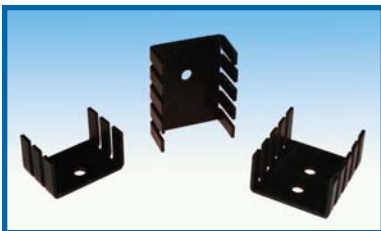

Channel style heat sink with wide mounting surface and selection of lengths to accept a variety of devices. Models accommodate one or two devices.

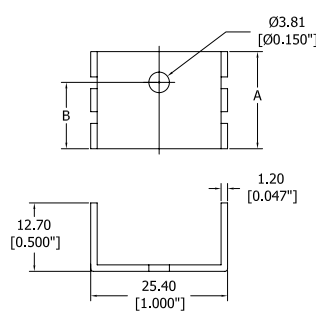

Fig. A

RT1650B00000

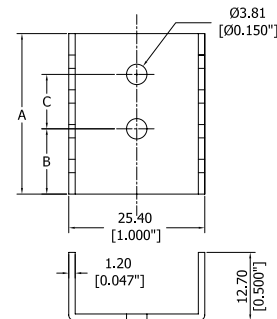
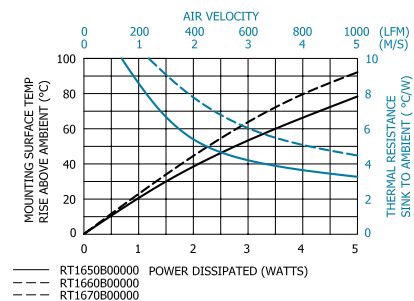

Fig. B

RT1660B00000, RT1670B00000

Aluminum, Black Anodized

Part Number	Fig.	"A" Dim mm (In.)	"B" Dim mm (In.)	"C" Dim mm (In.)
RT1650B00000	A	18.03 (0.710)	12.32 (0.485)	N/A
RT1660B00000	B	29.97 (1.180)	11.68 (0.460)	N/A
RT1670B00000	B	29.97 (1.180)	12.19 (0.480)	10.16 (0.400)





Flat back extruded heat sink with solderable pins for TO-220 & TO-218

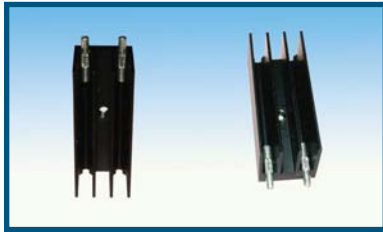

Flat back extruded heat sink features solderable pins which allow vertical mounting without stress on the device leads. Available in three heights for TO-220 and TO-218 devices.

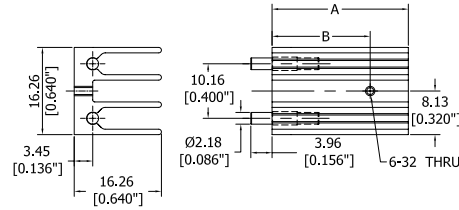

Aluminum, Black Anodized

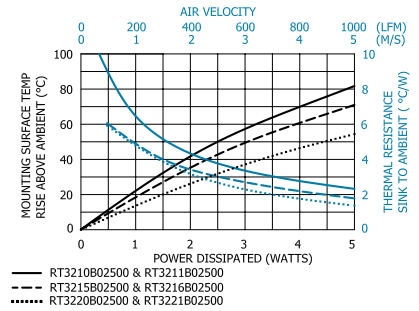

Part Number	Device	"A" Dim mm (In.)	"B" Dim mm (In.)	Dia. of PCB Plated Thru hole for Tabs
RT3210B02500	TO-220	25.40 (1.00)	18.29 (0.720)	2.67 (0.105)
RT3211B02500	TO-218	25.40 (1.00)	21.59 (0.850)	2.67 (0.105)
RT3215B02500	TO-220	38.10 (1.50)	18.29 (0.720)	2.67 (0.105)
RT3216B02500	TO-218	38.10 (1.50)	21.59 (0.850)	2.67 (0.105)
RT3220B02500	TO-220	50.80 (2.00)	18.29 (0.720)	2.67 (0.105)
RT3221B02500	TO-218	50.80 (2.00)	21.59 (0.850)	2.67 (0.105)

Extruded heat sink with radial fins for TO-220, TO-218 and TO-247



Extruded heat sink with radial fins feature equal channel widths on both sides for single or dual device mounting. Includes two solderable mounting pins which permit vertical mounting to eliminate stress on device leads. Available in four heights for TO-220, TO-218, and TO-247 devices.

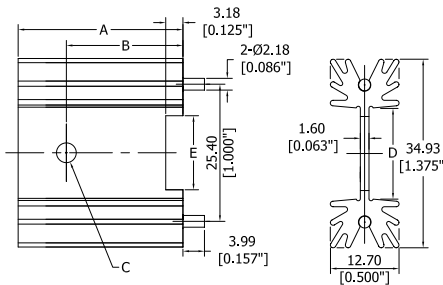

Aluminum, Black Anodized

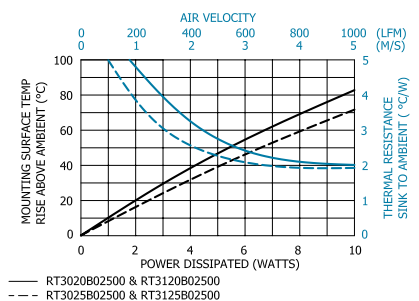
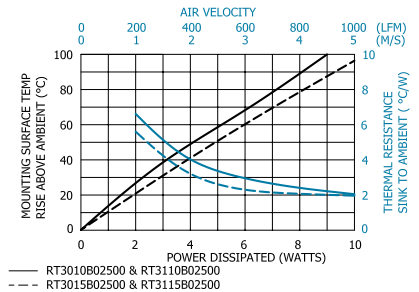

Part Number	Device	"A" Dim mm (In.)	"B" Dim mm (In.)	"C" Dim mm (In.)	"D" Dim mm (In.)	"E" Dim mm (In.)	Dia. of PCB Plated Thru hole for Tabs
RT3010B02500	TO-218, TO-247	25.40 (1.00)	21.59 (0.850)	3.66 (0.144)	17.02 (0.670)	13.72 (0.540)	2.67 (0.105)
RT3110B02500	TO-220	25.40 (1.00)	18.29 (0.720)	3.17 (0.125)	15.88 (0.625)	11.10 (0.437)	2.67 (0.105)
RT3015B02500	TO-218, TO-247	38.10 (1.50)	21.59 (0.850)	3.66 (0.144)	17.02 (0.670)	13.72 (0.540)	2.67 (0.105)
RT3115B02500	TO-220	38.10 (1.50)	18.29 (0.720)	3.17 (0.125)	15.88 (0.625)	11.10 (0.437)	2.67 (0.105)
RT3020B02500	TO-218, TO-247	50.80 (2.00)	21.59 (0.850)	3.66 (0.144)	17.02 (0.670)	13.72 (0.540)	2.67 (0.105)
RT3120B02500	TO-220	50.80 (2.00)	18.29 (0.720)	3.17 (0.125)	15.88 (0.625)	11.10 (0.437)	2.67 (0.105)
RT3025B02500	TO-218, TO-247	63.50 (2.500)	21.59 (0.850)	3.66 (0.144)	17.02 (0.670)	13.72 (0.540)	2.67 (0.105)
RT3125B02500	TO-220	63.50 (2.500)	18.29 (0.720)	3.17 (0.125)	15.88 (0.625)	11.10 (0.437)	2.67 (0.105)



Extruded heat sink with large radial fins for TO-220, TO-218 and TO-247

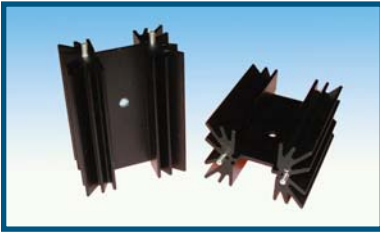

Extruded heat sink with large radial fins features equal channel widths on both sides for single or dual device mounting. Includes two solderable mounting pins which permit vertical mounting and eliminates stress on device leads. Available in four heights for TO-220, TO-218 and TO-247 devices.

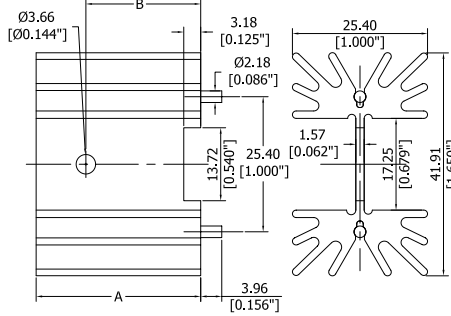

Note: Notch optional see chart below

Aluminum, Black Anodized

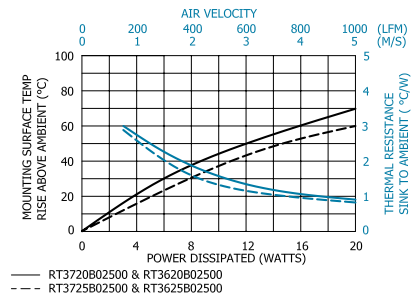
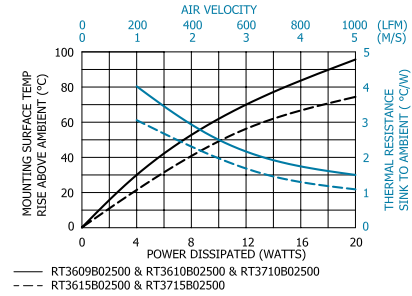

Part Number	Device	"A" Dim mm (In.)	"B" Dim mm (In.)	Base Notch	Dia. of PCB Plated Thru hole for Tabs
RT3609B02500	TO-220	25.40 (1.00)	18.29 (0.720)	No Notch	2.67 (0.105)
RT3610B02500	TO-218, TO-247	25.40 (1.00)	21.59 (0.850)	No Notch	2.67 (0.105)
RT3710B02500	TO-218, TO-247	25.40 (1.00)	21.59 (0.850)	Notch	2.67 (0.105)
RT3615B02500	TO-218, TO-247	38.10 (1.50)	21.59 (0.850)	No Notch	2.67 (0.105)
RT3715B02500	TO-218, TO-247	38.10 (1.50)	21.59 (0.850)	Notch	2.67 (0.105)
RT3620B02500	TO-218, TO-247	50.80 (2.00)	21.59 (0.850)	No Notch	2.67 (0.105)
RT3720B02500	TO-218, TO-247	50.80 (2.00)	21.59 (0.850)	Notch	2.67 (0.105)
RT3625B02500	TO-218, TO-247	63.50 (2.50)	21.59 (0.850)	No Notch	2.67 (0.105)
RT3725B02500	TO-218, TO-247	63.50 (2.50)	21.59 (0.850)	Notch	2.67 (0.105)

High power extruded heat sink with large radial fins for TO-220 and Multiwatt



High power extruded heat sink with large radial fins and increased fin count for additional cooling capacity. Solderable pins allow vertical mounting without stress on device leads. Available in four heights for TO-220 and multi-watt devices.

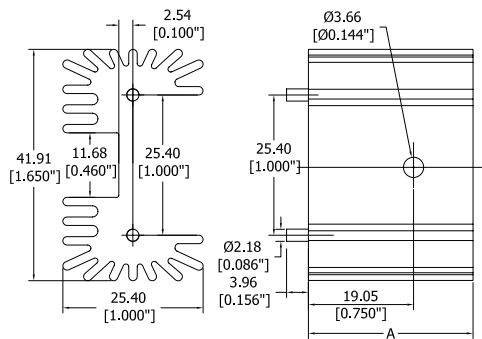

Aluminum, Black Anodized

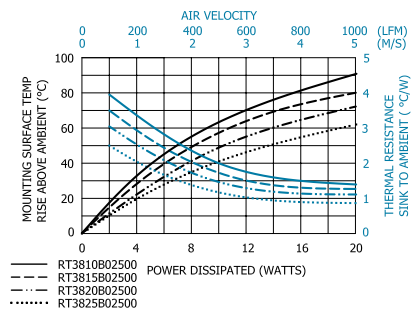

Part Number	"A" Dim mm (In.)	Dia. of PCB Plated Thru hole for Tabs
RT3810B02500	25.40 (1.00)	2.67 (0.105)
RT3815B02500	38.10 (1.50)	2.67 (0.105)
RT3820B02500	50.80 (2.00)	2.67 (0.105)
RT3825B02500	63.50 (2.50)	2.67 (0.105)



Heat sinks for "Full-Brick" DC/DC Converters

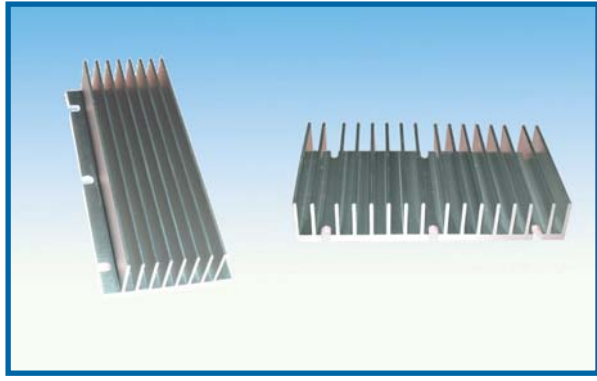

Heat sinks for "Full-Brick" DC/DC Converters

Standard mounting slots mate with Vicor DC/DC converters.

Optimized aluminum extruded fin construction transfers heat efficiently and keeps converter modules cool in both forced and natural convection applications.

Three fin heights and two flow directions, vertical and horizontal are available.

Aluminum, Clear trivalent chromate finish is standard.

Polar Thermal interface materials are available. Contact the factory to select the material for your application.

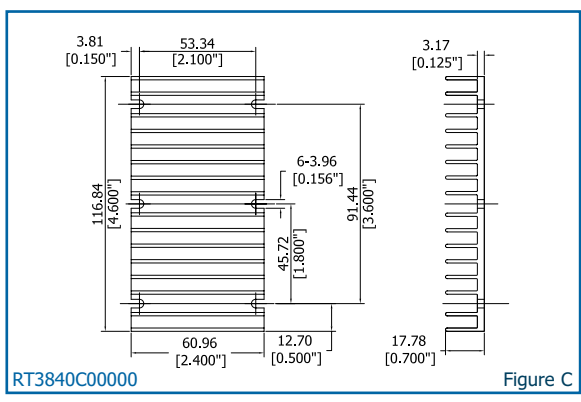
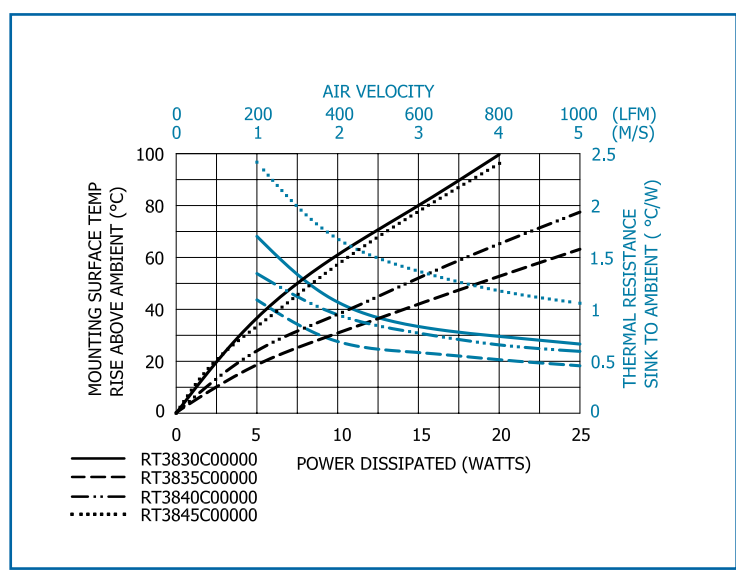
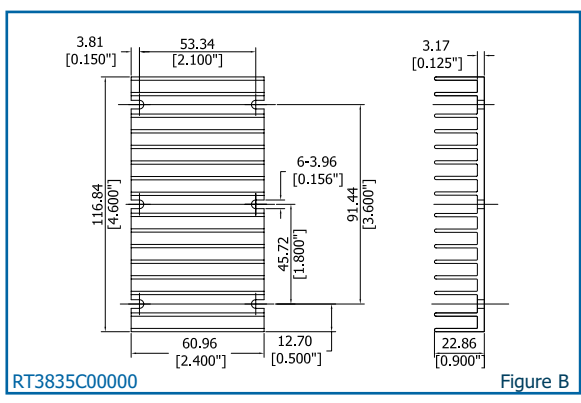
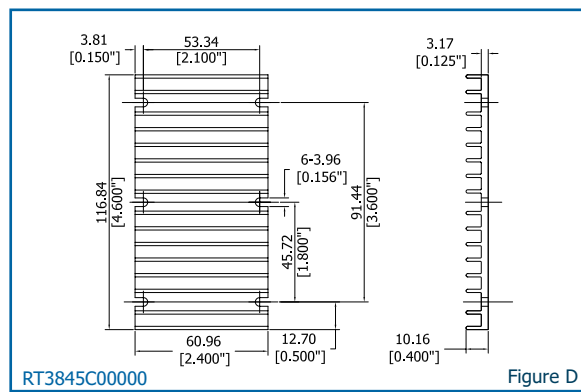
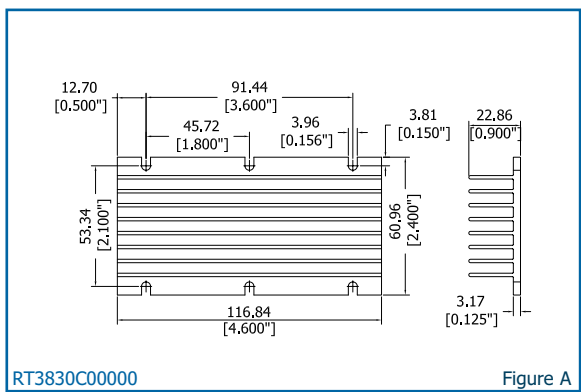

Part Number	Fig.	Footprint Dimensions mm (in.)	Height mm (in.)	Fin Orientation	Number of fins
RT3830C00000	A	116.8 (4.60) x 61.0 (2.40)	22.9 (0.90)	Horizontal	8
RT3835C00000	B	61.0 (2.40) x 116.8 (4.60)	22.9 (0.90)	Vertical	16
RT3840C00000	C	61.0 (2.40) x 116.8 (4.60)	17.8 (0.70)	Vertical	16
RT3845C00000	D	61.0 (2.40) x 116.8 (4.60)	10.2 (0.40)	Vertical	16



Heat sinks for "Half-Brick" DC/DC Converters

Heat sinks for "Half-Brick" DC/DC Converters

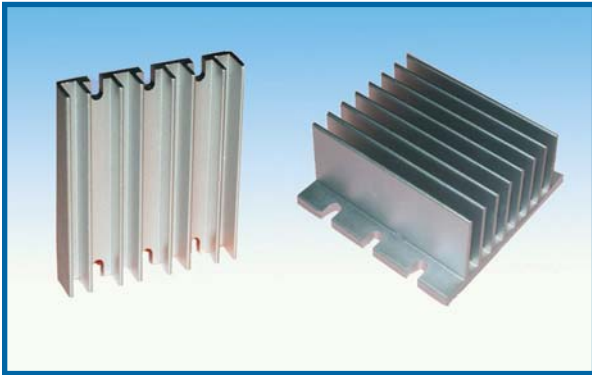

Standard mounting slots mate with Vicor and the majority of "half-brick" DC/DC converters on the market.

Optimized aluminum extruded fin construction transfers heat efficiently and keeps converter modules cool in both forced and natural convection applications.

Two fin heights and two flow directions, vertical and horizontal are available.

Aluminum, Clear trivalent chromate finish is standard.

Polar Thermal interface materials available. Contact the factory to select the material for your application.

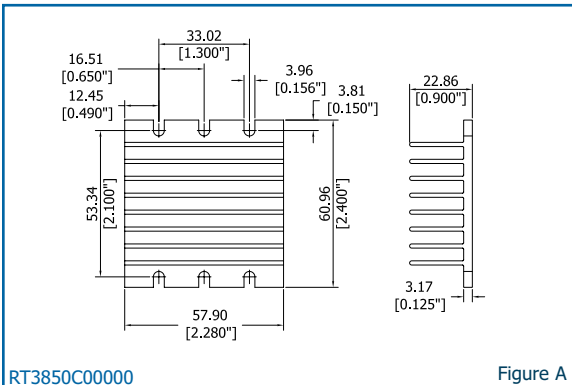

RT3850C00000

Figure A

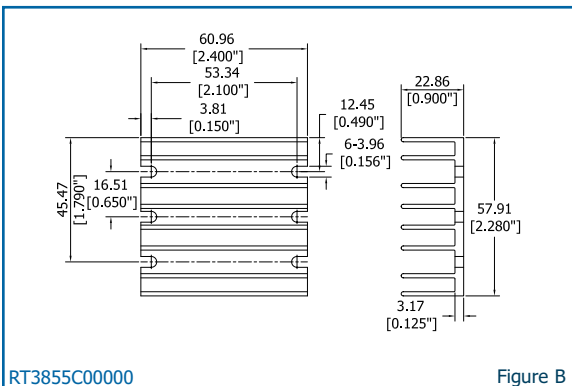

RT3855C00000

Figure B

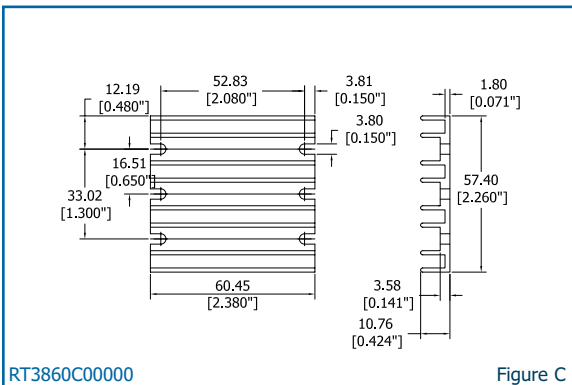

RT3860C00000

Figure C

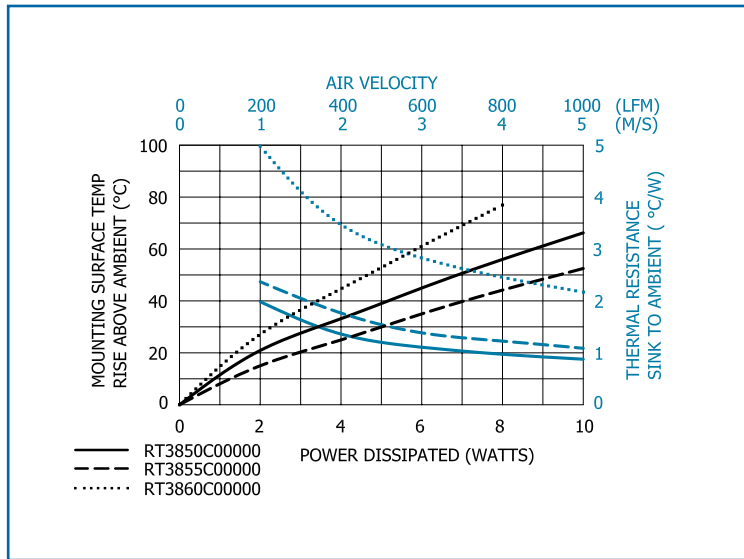

Part Number	Fig.	Footprint Dimensions mm (in.)	Height mm (in.)	Fin Orientation	Number of fins
RT3850C00000	A	57.9 (2.28) x 61.0 (2.40)	22.9 (0.90)	Horizontal	8
RT3855C00000	B	61.0 (2.40) x 57.9 (2.28)	22.9 (0.90)	Vertical	8
RT3860C00000	C	60.5 (2.38) x 57.4 (2.26)	10.7 (0.42)	Vertical	8



Extruded Heat Sink for Solid State Relays

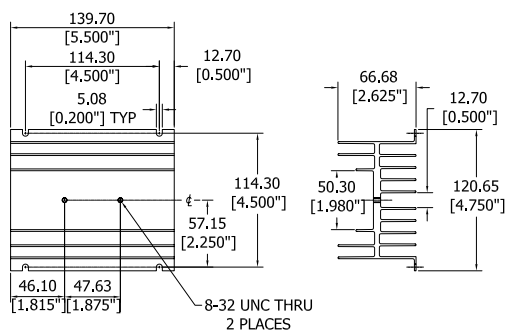
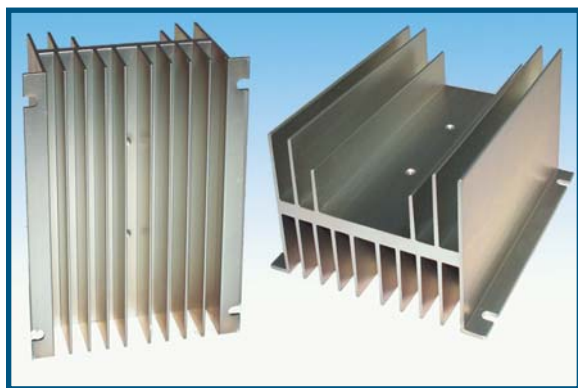

Extruded Heat Sink for Solid State Relays features

Four standard mounting slots accommodate easy assembly.

Two 8-32 threaded thru holes can accept one solid state relay with 1.875 center distance.

Fins on outside of mounting channel optimizes heat transfer.

Thermal interface compounds and pad materials available see pages 18-20 or contact the factory to select the correct material for your application.

Aluminum, Clear trivalent chromate finish

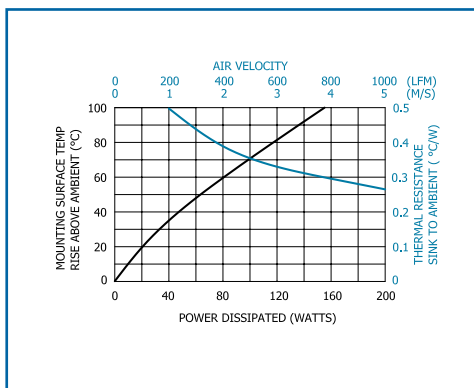

Part Number	Footprint Dimensions mm (in.)	Height mm (in.)
RT3975C00000	139.7 (5.500) x 120.65 (4.75)	66.68(2.625)

Fabfin High Performance Heat Sink for Solid State Relays

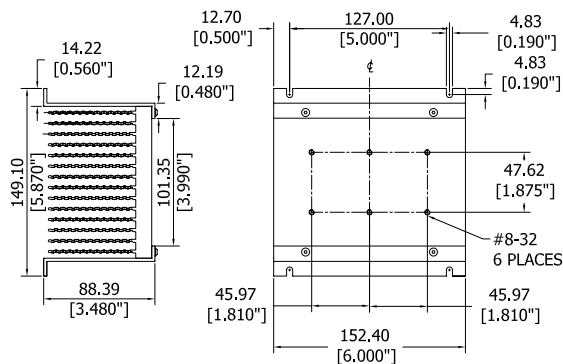
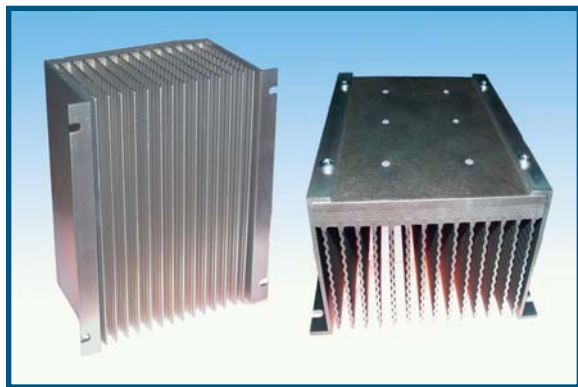

Fabfin High Performance Heat sink for Solid State Relays features

Four standard mounting slots accommodate easy assembly.

Six 8-32 threaded thru holes can accept three solid state relay with 1.875 center distance.

High fin density construction provides excellent heat transfer characteristics.

Thermal interface compounds and pad materials available see pages 18-20 or contact the factory to select the correct material for your application.

Aluminum, Clear trivalent chromate finish

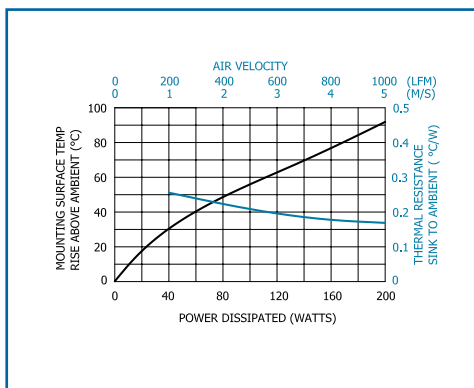

Part Number	Footprint Dimensions mm (in.)	Height mm (in.)
RT3980C00000	152.40 (6.00) x 149.10 (5.87)	88.39 (3.480)



FABFIN Standards - Various Widths Available in Serrated or Corrugated Fins

The R-Theta® range of standard Fabfin® forced convection cooled heat sinks (FFC series) was developed to incorporate standard 119mm square axial fans. The fin spacing of 8.51 mm was selected to provide a 20:1 ratio, the practical heat transfer limit for cooling Power Semiconductors in typical ambient conditions. The standard FFC series shown will accept 1, 2, 3 or 4 (not shown) fans. Available in many finishes.

The serrated fin thickness of 2.4mm provides near optimum performance when using industry standard axial fans. If some level of performance de-rating is acceptable (approximately 20%) then we recommend that corrugated fins be used. These have a thickness of 1.5 mm and are designated by ordering the 'AC' part numbers. The use of corrugated fins provides a weight savings of approximately 15% and will increase surface area by 7% compared with a straight fin of the same height.

The push/pull (PP) option is common for applications where fan redundancy is important. We recommend the use of ball bearing fan(s), specifically for the "pull" end, in order to maximize the fan life due to the elevated operating temperatures. The additional weight of the fan can be offset by using the corrugated fins, if applicable.

The adjacent graphs provide a performance guide for heat generating devices ranging in size from point source to 60% coverage.

FFC SERIES WITH SIDE FASTENED LEGS AND FAN BRACKET

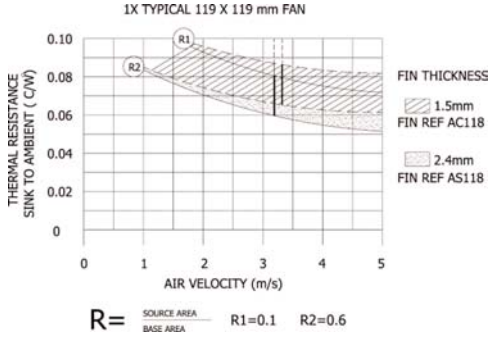
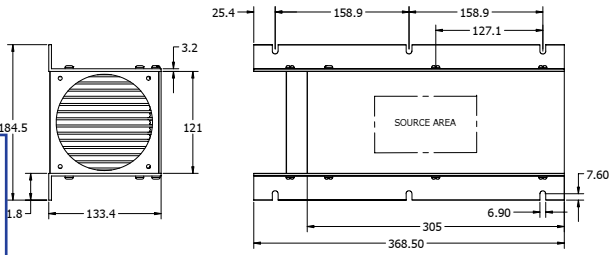
TECHNICAL DATA				
MODAL #	FFC305T13A14AS118B		FFC305T13A14AC118B	
FIN STYLE	SERRATED		CORRUGATED	
WT WITHOUT FAN	5.4	kg	4.7	kg
BASE AREA	36,774	mm ²	36,774	mm ²
TOTAL CSA	5,091	mm ²	4,242	mm ²
TOTAL PERIMETER	3,683	mm	3,749	mm

TECHNICAL DATA				
MODAL #	FFC305T13A30AS118B		FFC305T13A30AC118B	
FIN STYLE	SERRATED		CORRUGATED	
WT WITHOUT FAN	10.4	kg	8.8	kg
BASE AREA	78,387	mm ²	78,387	mm ²
TOTAL CSA	10,889	mm ²	8,981	mm ²
TOTAL PERIMETER	7,800	mm	7,929	mm

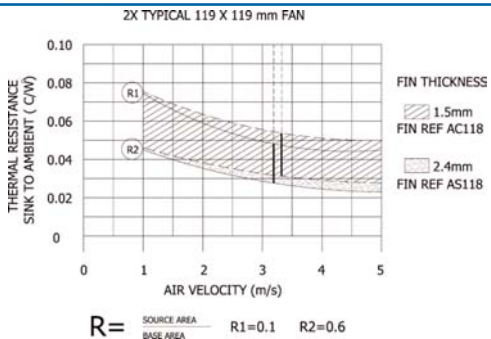
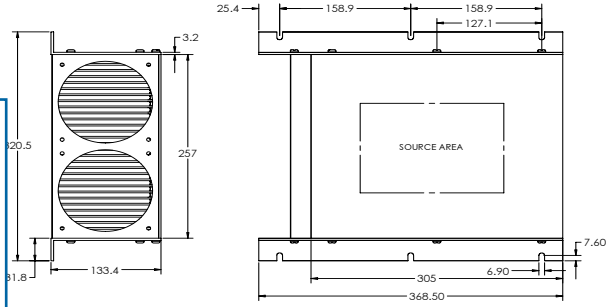
TECHNICAL DATA				
MODAL #	FFC305T13A46AS118B		FFC305T13A46AC118B	
FIN STYLE	SERRATED		CORRUGATED	
WT WITHOUT FAN	15.5	kg	13.2	kg
BASE AREA	119,865	mm ²	119,865	mm ²
TOTAL CSA	16,574	mm ²	13,766	mm ²
TOTAL PERIMETER	11,991	mm	12,578	mm

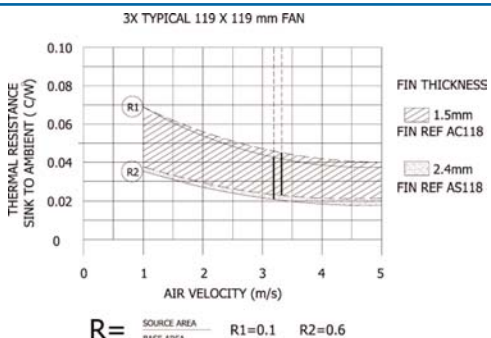
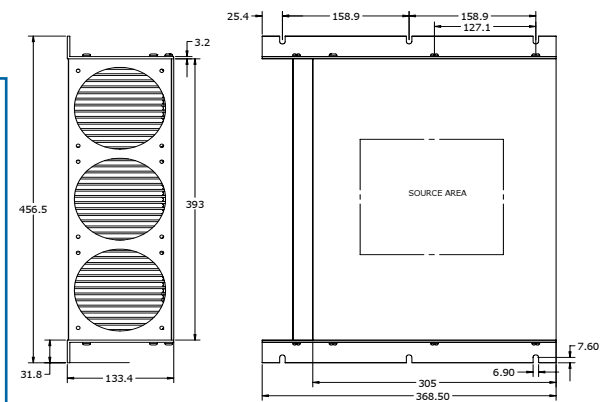

Polar Silicone Thermal Compound

Polar Silicone Thermal Compound

Polar RT7002 - RT7080 is a non-reactive, Silicone, Thermally Conductive Grease with a high thermal conductivity and low thermal resistance with a soft, non-flowable consistency. This product is formulated with specialty binding agents to achieve lowest amount of bleed and evaporation. It is designed for applications where a silicone thermal interface material is required.

Key Features

- Good Thermal Conductivity (0.80 W/m⁰k)
- Low Interface Thermal Resistance - (0.05 °C-In²/W)
- Thin Bond lines to < 1 mil.
- Low bleed and evaporation

Benefits

- Non-Toxic.
- Reworkable/Easy to Remove.
- Easy to apply by dispensing or Screen printing/stencil.

Typical Applications

Applied to the base and mounting studs of transistors, diode and silicon controlled rectifiers.

Can be used as a high-voltage corona suppressant/non-flammable coating, in connections for fly back transformers located in TV sets and similar design applications.

Used in mounting semiconductor devices; thermoelectric modules; power transistors and diodes; coupling entire heat generating assemblies to chassis; mounting power resistors; and for any devices where efficient cooling is required in major industries including, electronic (computer, appliance, wireless, etc.) automotive and electrical.

Typical Properties	RT7002 - RT7080
Viscosity:	Thixotropic Paste
Specific Gravity, @ 25 ⁰ C	2.2
Color:	White
Evaporation, @ 200 ⁰ C, 24 Hrs., %/Wt.	0.6
Thermal Conductivity, (ASTM D5470) W/m. ⁰ K	0.80
Thermal Resistance (°C-in ² /W)	0.05
Electrical Properties: Dielectric strength (ASTM D150) 0.05" gap, V/mil	390
Volume Resistivity (ASTM D257) Ohm-cm.	2.8 x 10 ¹⁴
Operating Temperature Range	-55 ⁰ C to 205 ⁰ C
Shelf Life	5 Years



Part Number	Description	Package Size & Type
RT7002U00000	Silicone Compound	2 Oz. Jar
RT7004U00000	Silicone Compound	4 Gram Pack
RT7005U00000	Silicone Compound	5 Oz. Tube
RT7008U00000	Silicone Compound	8 Oz. Jar
RT7010U00000	Silicone Compound	10 CC Syringe
RT7080U00000	Silicone Compound	5 lb Quart Jar



Polar Non-Silicone Thermal Compound

Polar Non-Silicone Thermal Compound

Polar RT7102 - RT7180 is grease-like Non-Silicone, non-migrating material heavily impregnated with heat-conductive metal oxides. This formulation provides high thermal conductivity, low bleed and high temperature stability.

Key Features

- Non-Silicone offers advantages of no creep or migration over wide temperature range.
- Low Interface Thermal Resistance - (0.03°C-in²/W)
- High Thermal Conductivity, High dielectric strength.
- Exceptionally low bleed and evaporation.
- Meets MIL-C-47113 & MIS-19846 specifications.

Polar RT7203 is grease-like Non-Silicone based reworkable, silver filled thermally and electrically conductive grease. Engineered with specially selected pure silver particles to maximize particle-to-particle contact for most efficient heat transfer and low resistivity.

Key Features

- Thermally and Electrically Conductive
- Low Interface Thermal Resistance - (0.005°C-in²/W)
- High Thermal Conductivity, (7.0 W/m²K)
- Low Resistivity, (< 0.01 Ohm-cm)
- Exceptionally low bleed and evaporation.
- Non-Silicone offers advantages of no creep or migration over wide temperature range.

Polar RT7280 is grease-like Non-Silicone, non-migrating material thickened with heat conductive fillers, low bleed and high temperature stability.

Key Features

- Formulated with low viscosity for easy dispensing and screen printing/stencil, and automated dispensing.
- Thin bond lines of 1-2 mil.
- Non-Silicone offers advantages of no creep or migration over wide temperature range.
- Low Interface Thermal Resistance - (0.03°C-in²/W)
- High Thermal Conductivity, High dielectric strength.
- Exceptionally low bleed and evaporation.
- Meets MIL-C-47113 & MIS-19846 specifications.

Benefits

- Will not harden, dry out or melt.
- Will not contaminate solder bath or other devices.
- Non-toxic.
- Reworkable and easy to apply, remove and dispense.

Typical Applications

Used in mounting semiconductor devices; thermoelectric modules; power transistors and diodes; mounting power resistors; and for any devices where efficient cooling is required in major industries including, electronic (computer, appliance, wireless, etc.) automotive and electrical.

Typical Properties	RT7102-RT7180	RT7203	RT7280
Viscosity:	Thixotropic Paste	Thixotropic Paste	Thixotropic Paste
Specific Gravity, @ 25°C	2.7	4.0	2.4
Color:	White	Silver/Gray	Blue
Evaporation, @ 200°C, 24 Hrs.,%/Wt.	0.3	0.4	0.6
Thermal Conductivity, (ASTM D5470) W/m. ² K	1.0	7.0	0.80
Thermal Resistance (°C-in ² /W)	0.03	0.005	0.03
Electrical Properties: Dielectric strength (ASTM D150) 0.05" gap, V/mil	350	N/A	310
Volume Resistivity (ASTM D257) Ohm-cm.	1.8 x 10 ¹⁴	<0.010	1.54 x 10 ¹⁴
Operating Temperature Range	-55°C to 200°C	-55°C to 200°C	-55°C to 200°C
Shelf Life	5 Years	5 Years	5 Years

Part Number	Description	Package Size & Type
RT7102U00000	Non-Silicone Compound	2 Oz. Jar
RT7104U00000	Non-Silicone Compound	4 Oz. Tube
RT7110U00000	Non-Silicone Compound	10 CC Syringe
RT7180U00000	Non-Silicone Compound	5 lb Quart Jar
RT7203U00000	Non-Silicone Compound	3 CC Syringe
RT7280U00000	Non-Silicone Compound LV	5 lb Quart Jar





Polar Thermally Conductive Sil-Pads

Polar Sil-Pad is a composite of silicone rubber and fiberglass. The material is specially formulated for use as a thermally conductive insulator.

Key Features

Surfaces are pliable and allow complete surface contact with excellent heat dissipation. The reinforcing fiberglass provides excellent cut-through resistance.

Benefits

Thermal impedance $1.13^{\circ}\text{C}\cdot\text{in}^2/\text{W}(@50\text{ psi})$
 Excellent mechanical and physical characteristics.
 Flame retardant

Typical Applications

Used in power supplies, power semiconductors, automotive electronics, telecommunications and motor controls.

Configurations Available are sheet form, die-cut parts, and roll form; with or without pressure sensitive adhesive.

Typical Properties	POLAR SIL-PAD
Color	Gray
Thickness, mm (in.)	.18 + .025 (.007 ± .001)
Thermal Performance TO-220 Test @ 50 psi $^{\circ}\text{C}/\text{W}$	5.14
Thermal Impedance ($^{\circ}\text{C}\cdot\text{in}^2/\text{W}$)	1.13
Thermal Conductivity, (W/m-k nominal)	0.9
Voltage Breakdown, (Vac)	3500
Continuous Use Temperature ($^{\circ}\text{C}$)	-60 to 180
Construction	Silicone / Fiberglass

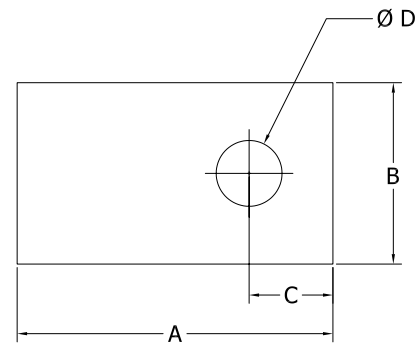

Part Number	TO Package	"A" Dim mm (In.)	"B" Dim mm (In.)	"C" Dim mm (In.)	"D" Dim mm (In.)	Adhesive on one side
RT7200U10000	TO-220 (Clip Mount)	19.1(.750)	12.7(.500)			No
RT7210U10000	TO-220	19.1(.750)	12.7(.500)	4.8(.187)	3.7(.147)	No
RT7220U10000	TO-220	19.1(.750)	12.7(.500)	4.8(.187)	3.2(.125)	No
RT7230U10000	TO-218	21.8(.860)	18.8(.740)	5.1(.200)	4.1(.160)	No
RT7240U10000	TO-247	25.4(1.000)	19.1(.750)	7.6(.300)	3.6(.140)	No
RT7250U10000	TO-247	29.0(1.140)	20.6(.810)	9.0(.355)	3.7(.147)	No

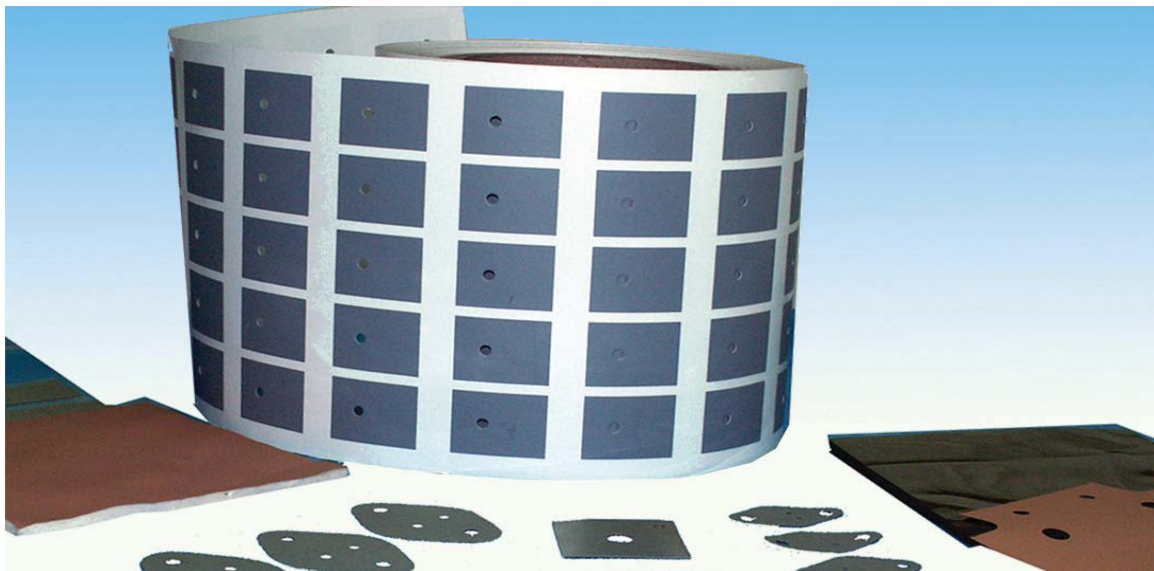

Note: Contact R-Theta for other configurations and materials



Polar Thermally Conductive Adhesive Tapes

Ceramic or metal packages

T405 thermal tape consists of a high bond strength, pressure-sensitive acrylic adhesive, loaded with aluminum oxide and coated onto a 0.050 mm (0.002 inch) aluminum foil carrier. The aluminum foil provides added thermal conductivity for applications where electrical isolation is not required.

T412 thermal tape consists of a high bond strength, pressure-sensitive acrylic adhesive, loaded with titanium diboride and applied to an expanded aluminum carrier. The combination of filler, expanded metal and embossed surface enhances both tape conformability and thermal performance.

Typical Properties	T405	T412
Carrier	Aluminum	Expanded Al
Color	White	Grey
Thickness, mm (in.)	0.152 (0.006)	0.229 (0.009)
Thermal Impedance @<1 psi, °C-in ² /W (°C-cm ² /W)	0.5 (3.4)	0.25 (1.7)
Thermal Conductivity, W/m-k	0.50	1.40
Voltage Breakdown, Vac	N/A	N/A
Volume Resistivity, ohm-cm	N/A	1.3 x 10 ⁻²
Flammability Rating (E140244)	V-0	Not Rated
Lap Shear Adhesion, psi (MPa)	135 (0.931)	70 (0.483)
Die Shear Adhesion, psi (MPa)		
Aluminum 25°C	125 (0.862)	135 (0.931)
150°C	55 (0.379)	25 (0.172)
Aluminum Oxide Substrate 25°C	145 (1.00)	125 (0.862)
150°C	60 (0.414)	40 (0.276)
Creep Adhesion, days		
25°C, 12 psi (0.083MPa)	>50	>50
150°C, 12 psi (0.083MPa)	>50	>50
Adhesive CTE, ppm/°C, -40 to +150°C	400	400



How to order

Ordering Code	Tape Option
05	T405
10	T410
11	T411
12	T412

Example P/N RT5635B000 __ (Last two digits tape option)

1. Part Number RT5635B000000
2. Choose a tape option T405 (05), T410 (10), T411 (11) or T412 (12)
3. Then add the ordering code (05,10,11,12) to your part number (by replacing the last two digits.)

For Example: To order tape option T410 (10) with the part number RT5635B00000 the completed part number to order would be **RT5635B00010**.

Plastic packages

T410 tape consists of a high bond strength, pressure sensitive acrylic adhesive loaded with aluminum oxide and coated onto a 0.05 mm (0.002 inch) aluminum foil carrier. The other side of the foil carrier has a silicone pressure sensitive adhesive which provides excellent adhesion to silicone-contaminated plastics and other low energy surfaces.

T411 tape consists of a high bond strength pressure-sensitive adhesive with an expanded aluminum mesh carrier layer. The mesh carrier allows the tape to conform to curved surfaces of plastic molded IC packages, providing a high adhesive strength attachment for heat sinks. The high performance silicone PSA allows adhesion to silicone-contaminated plastics and other low energy surfaces.

Typical Properties	T410	T411
Carrier	Aluminum Foil	Aluminum Mesh
Adhesive (to heat sink side)	Acrylic	Silicone
Color (to heat sink side)	White	Clear (Silver)
Adhesive (onto component side)	Silicone	Silicone
Color (to component side)	Clear (Silver)	Clear (Silver)
Thickness, mm (in.)	0.18 (0.007)	0.28 (0.011)
Thermal Impedance @<1 psi, °C-in ² /W (°C-cm ² /W)	1.1 (7.1)	1.0 (6.5)
Operating Temperature Range, °C	- 50 to +150	- 50 to +150
Voltage Breakdown, Vac	N/A	N/A
Volume Resistivity, ohm-cm	N/A	N/A
Lap Shear Adhesion, psi (MPa)	60 (0.414)	14 (0.094)
Die Shear Adhesion, psi (MPa)		
Steel/FR4 25°C	170 (1.172)	80 (0.552)
125°C	40 (0.276)	20 (0.138)

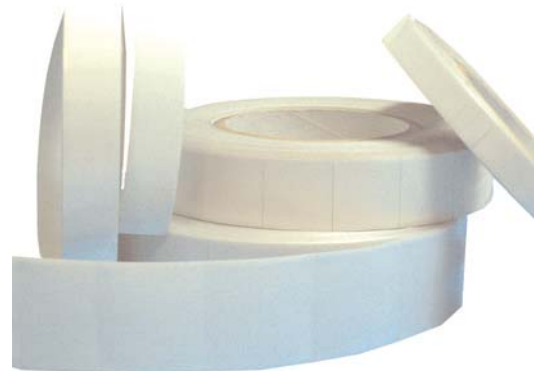



Extruded Aluminum Heat Sink Profiles

THE MULTI-PURPOSE ALLOY - 6063-T5

6063 is a multi-purpose alloy that is most widely used for heat sinks and architectural hardware because it is extrudable into complex shapes and lends itself to anodized coating. The T5 temper provides sufficient hardness for ease of machinability. 6063-T5 is the aluminum extrusion most commonly used by R-Theta.

After entering the URL listed below, click on a part number to view an image of the Extrusion. Sort the table by clicking on the columns titles. Selected part number is displayed beside the send quote button.

http://www.r-theta.com/products_aircooled_extrusion_create.asp

R-THETA OFFERS A BROAD RANGE OF EXTRUSION PROFILES

If you cannot locate an extrusion profile that meets your requirements, contact the factory or web site for additional profiles that have become available or alternatives. If a custom solution is required R-Theta will assist you to design a new profile that meets your requirements both mechanical and Thermal.

Six foot (72") lengths are standard; however, other lengths are available.

EXTRUSION CHARACTERISTICS TABLE

Profile Number	Part Number To Order (72")	Perimeter mm (in)	Weight Kg/m (lb/ft)	Thermal Resistance °C/W/3"
9000	RT9000U07200	927 (36.5)	4.0 (2.7)	1.8
9001	RT9001U07200	1,422 (56)	5.1 (3.4)	1.5
9002	RT9002U07200	2,487 (97.9)	13.8 (9.3)	0.7
9003	RT9003U07200	1,590 (62.6)	7.1 (4.8)	1.1
9004	RT9004U07200	1,854 (73.0)	10.4 (7.0)	1.0
9005	RT9005U07200	2,817 (110.9)	27.8 (18.7)	0.7
9006	RT9006U07200	1,979 (77.9)	7.6 (5.1)	0.9
9007	RT9007U07200	2,543 (100.1)	10.6 (7.1)	0.7
9008	RT9008U07200	1,481 (58.3)	3.6 (2.4)	1.2
9009	RT9009U07200	1,011 (39.8)	4.0 (2.7)	1.5
9010	RT9010U07200	2,339 (92.1)	24.4 (16.4)	0.8
9011	RT9011U07200	990 (39.0)	4.5 (3.0)	1.6
9012	RT9012U07200	2,941 (115.8)	17.6 (11.8)	0.5
9013	RT9013U07200	3,400 (133.8)	13.1 (8.8)	0.8
9014	RT9014U07200	1,278 (50.3)	6.1 (4.1)	1.4
9015	RT9015U07200	2,042 (80.4)	10.0 (6.7)	0.9
9016	RT9016U07200	2,223 (87.5)	11.0 (7.4)	0.8
9017	RT9017U07200	2,954 (116.3)	11.3 (7.6)	0.5
9018	RT9018U07200	2,316 (91.2)	16.5 (11.1)	0.8
9019	RT9019U07200	2,804 (110.4)	17.6 (11.8)	0.6
9020	RT9020U07200	2,286 (90.0)	16.1 (10.8)	0.9
9021	RT9021U07200	1,344 (52.9)	5.3 (3.6)	1.4
9022	RT9022U07200	1,886 (74.3)	6.1 (4.1)	0.8
9023	RT9023U07200	399 (15.7)	1.7 (1.2)	4.1
9024	RT9024U07200	2,736 (107.7)	8.8 (5.9)	1.2
9025	RT9025U07200	1,711 (67.4)	7.7 (5.2)	0.8
9026	RT9026U07200	1,503 (59.2)	6.6 (4.4)	0.9
9027	RT9027U07200	1,094 (43.1)	6.8 (4.6)	1.6

Note: There are many more sizes and styles available. Consult the website for a complete listing.

Extruded Aluminum Heat Sink Profiles

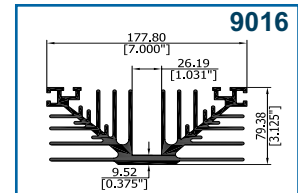
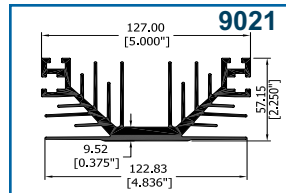
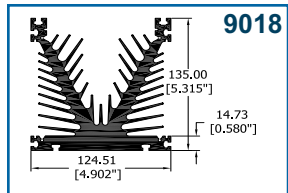
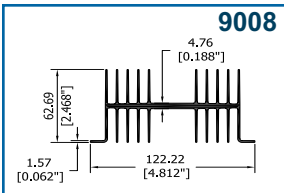
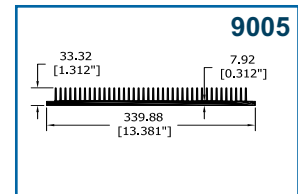
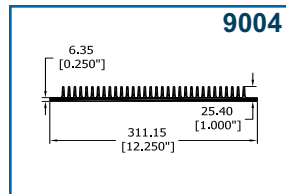
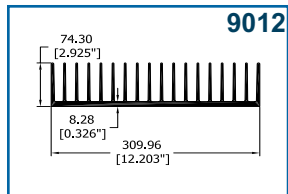
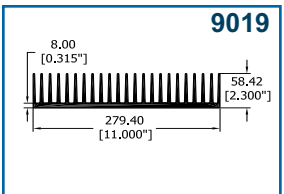
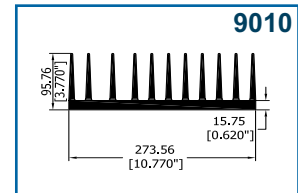
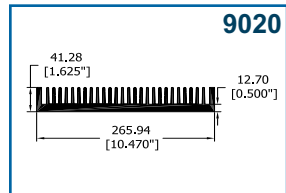
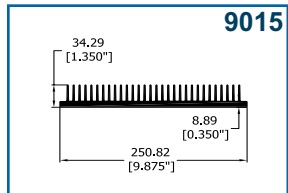
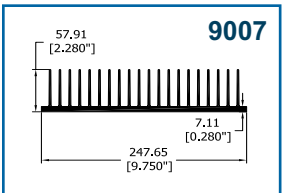
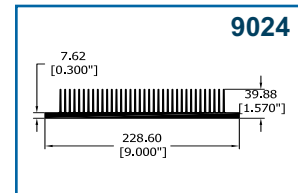
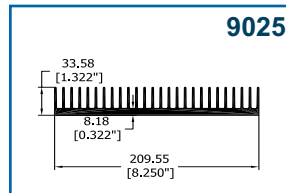
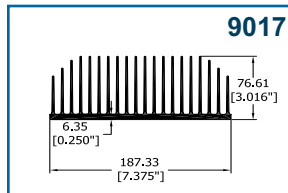
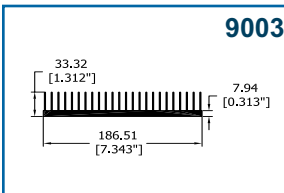
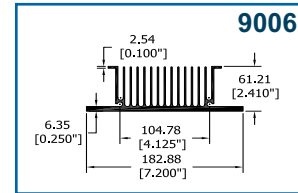
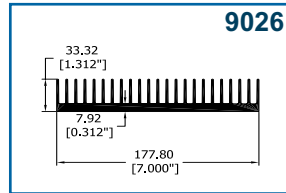
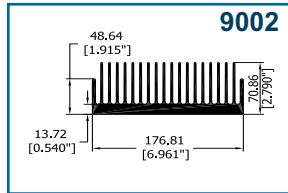
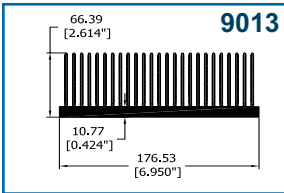
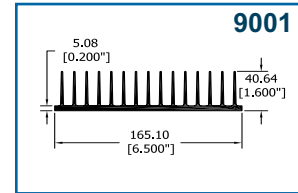
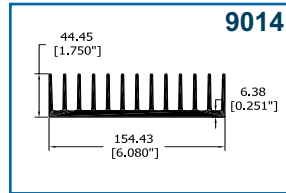
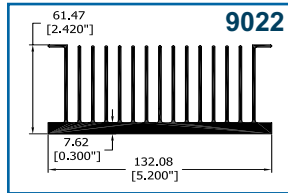
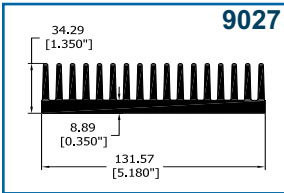
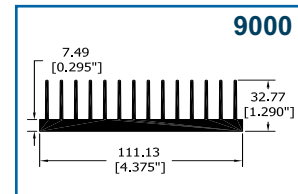
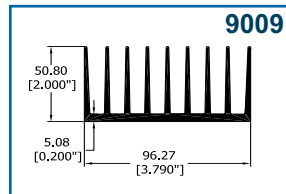
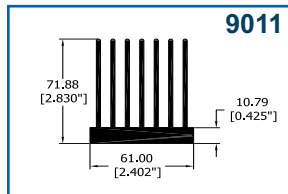
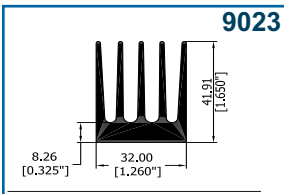

REFER TO TABLE ON PAGE 22

5 EASY STEPS TO CONFIGURE EXTRUSION

- STEP 1:** LOG ONTO www.r-theta.com
STEP 2: SELECT "PRODUCTS" ON MENU BAR
STEP 3: SELECT "AIRCOOLED" ON DROP DOWN MENU
STEP 4: SELECT "CREATE AN EXTRUSION"
STEP 5: SELECT "EXTRUSION CONFIGURATOR"

Select Extrusion to obtain detailed section information

Thermal Modeling of any "comb" Extrusion can be simulated at <http://r-tools.r-theta.com>

Index by Device Cooled

DC/DC Converters**R-Theta No. Page No.****Full-Brick**

RT3830C00000	14
RT3835C00000	14
RT3840C00000	14
RT3845C00000	14

Half-Brick

RT3850C00000	15
RT3855C00000	15
RT3860C00000	15

DIPS**R-Theta No. Page No.**

RT5470B00000	4
RT5475B00000	4

IC Packages, BGAs**R-Theta No. Page No.**

RT5025B00000	2
RT5035B00000	2
RT5045B00000	2
RT5060B00000	2
RT5125B00000	2
RT5135B00000	2
RT5145B00000	2
RT5160B00000	2
RT5235B00000	3
RT5240B00000	3
RT5265B00000	3
RT5325B00000	3
RT5335B00000	3
RT5345B00000	3
RT5360B00000	3
RT5425B00000	4
RT5435B00000	4
RT5445B00000	4
RT5460B00000	4
RT5526B00000	3
RT5553B00000	3
RT5625B00000	2
RT5635B00000	2
RT5645B00000	2
RT5660B00000	2

Multiwatt**R-Theta No. Page No.**

RT3810B02500	13
RT3815B02500	13
RT3820B02500	13
RT3825B02500	13

SMT**R-Theta No. Page No.****D-Pak TO-252**

RT1750D00000	5
--------------	---

D² Pak TO-263

RT1755D00000	5
--------------	---

D³ Pak TO-268

RT1760D00000	5
--------------	---

Solid State Relays**R-Theta No. Page No.**

RT3975C00000	16
RT3980C00000	16

TO-202**R-Theta No. Page No.**

RT3310B02500	11
RT3315B02500	11
RT3320B02500	11
RT3325B02500	11
RT3410B02500	10
RT3415B02500	10
RT3420B02500	10
RT3425B02500	10

TO-218**R-Theta No. Page No.**

RT1660B00000	11
RT1670B00000	11
RT3010B02500	12
RT3015B02500	12
RT3020B02500	12
RT3025B02500	12
RT3211B02500	12
RT3216B02500	12
RT3221B02500	12
RT3610B02500	13
RT3615B02500	13
RT3620B02500	13
RT3625B02500	13
RT3710B02500	13
RT3715B02500	13
RT3720B02500	13
RT3725B02500	13

TO-220**R-Theta No. Page No.**

RT1000B00000	6
RT1000B03100	6
RT1000B04000	6
RT1002B00000	6
RT1002B03100	6
RT1002B04000	6
RT1050B00000	7
RT1050B03100	7
RT1050B04000	7
RT1100B03400	7
RT1110B03400	7
RT1150B00000	9
RT1200B00000	9
RT1250B00000	9
RT1300B00000	7
RT1350B00000	10
RT1360B00000	10
RT1360B04000	10
RT1370B00000	10
RT1370B04000	10
RT1400B00000	10
RT1410B00000	10
RT1500B00000	8
RT1550B03400	8
RT1560B03400	8
RT1600B03400	8
RT1650B00000	11

TO-220 (Continued)**R-Theta No. Page No.**

RT1660B00000	11
RT1670B00000	11
RT1700B00000	9
RT3110B02500	12
RT3115B02500	12
RT3120B02500	12
RT3125B02500	12
RT3210B02500	12
RT3215B02500	12
RT3220B02500	12
RT3310B02500	11
RT3315B02500	11
RT3320B02500	11
RT3325B02500	11
RT3410B02500	10
RT3415B02500	10
RT3420B02500	10
RT3425B02500	10
RT3609B02500	13
RT3810B02500	13
RT3815B02500	13
RT3820B02500	13
RT3825B02500	13

TO-247**R-Theta No. Page No.**

RT3010B02500	12
RT3015B02500	12
RT3020B02500	12
RT3025B02500	12
RT3610B02500	13
RT3615B02500	13
RT3620B02500	13
RT3625B02500	13
RT3710B02500	13
RT3715B02500	13
RT3720B02500	13
RT3725B02500	13

TO-262**R-Theta No. Page No.**

RT1000B00000	6
RT1000B03100	6
RT1000B04000	6
RT1002B00000	6
RT1002B03100	6
RT1002B04000	6
RT1050B00000	7
RT1050B03100	7
RT1050B04000	7

Index by Part Number

R-Theta Part No.	Page No.	R-Theta Part No.	Page No.	R-Theta Part No.	Page No.	R-Theta Part No.	Page No.
RT1000B00000	6	RT3120B02500	12	RT5045B00000	2	RT7220U10000	20
RT1000B03100	6	RT3125B02500	12	RT5060B00000	2	RT7230U10000	20
RT1000B04000	6	RT3210B02500	12	RT5125B00000	2	RT7240U10000	20
RT1002B00000	6	RT3211B02500	12	RT5135B00000	2	RT7250U10000	20
RT1002B03100	6	RT3215B02500	12	RT5145B00000	2	RT7280U00000	19
RT1002B04000	6	RT3216B02500	12	RT5160B00000	2	RT9000U07200	22
RT1050B00000	7	RT3220B02500	12	RT5235B00000	3	RT9001U07200	22
RT1050B03100	7	RT3221B02500	12	RT5240B00000	3	RT9002U07200	22
RT1050B04000	7	RT3310B02500	11	RT5265B00000	3	RT9003U07200	22
RT1100B03400	7	RT3315B02500	11	RT5325B00000	3	RT9004U07200	22
RT1110B03400	7	RT3320B02500	11	RT5335B00000	3	RT9005U07200	22
RT1150B00000	9	RT3325B02500	11	RT5345B00000	3	RT9006U07200	22
RT1200B00000	9	RT3410B02500	10	RT5360B00000	3	RT9007U07200	22
RT1250B00000	9	RT3415B02500	10	RT5425B00000	4	RT9008U07200	22
RT1300B00000	7	RT3420B02500	10	RT5435B00000	4	RT9009U07200	22
RT1350B00000	10	RT3425B02500	10	RT5445B00000	4	RT9010U07200	22
RT1360B00000	10	RT3609B02500	13	RT5460B00000	4	RT9011U07200	22
RT1360B04000	10	RT3610B02500	13	RT5470B00000	4	RT9012U07200	22
RT1370B00000	10	RT3615B02500	13	RT5475B00000	4	RT9013U07200	22
RT1370B04000	10	RT3620B02500	13	RT5526B00000	3	RT9014U07200	22
RT1400B00000	10	RT3625B02500	13	RT5553B00000	3	RT9015U07200	22
RT1410B00000	10	RT3710B02500	13	RT5625B00000	2	RT9016U07200	22
RT1460U00000	7	RT3715B02500	13	RT5635B00000	2	RT9017U07200	22
RT1500B00000	8	RT3720B02500	13	RT5645B00000	2	RT9018U07200	22
RT1550B03400	8	RT3725B02500	13	RT5660B00000	2	RT9019U07200	22
RT1560B03400	8	RT3810B02500	13	RT7002U00000	18	RT9020U07200	22
RT1600B03400	8	RT3815B02500	13	RT7004U00000	18	RT9021U07200	22
RT1650B00000	11	RT3820B02500	13	RT7005U00000	18	RT9022U07200	22
RT1660B00000	11	RT3825B02500	13	RT7008U00000	18	RT9023U07200	22
RT1670B00000	11	RT3830C00000	14	RT7010U00000	18	RT9024U07200	22
RT1700B00000	9	RT3835C00000	14	RT7080U00000	18	RT9025U07200	22
RT1750D00000	5	RT3840C00000	14	RT7102U00000	19	RT9026U07200	22
RT1755D00000	5	RT3845C00000	14	RT7104U00000	19	RT9027U07200	22
RT1760D00000	5	RT3850C00000	15	RT7110U00000	19		
RT3010B02500	12	RT3855C00000	15	RT7180U00000	19		
RT3015B02500	12	RT3860C00000	15	RT7200U10000	20		
RT3020B02500	12	RT3975C00000	16	RT7203U00000	19		
RT3025B02500	12	RT3980C00000	16	RT7210U10000	20		
RT3110B02500	12	RT5025B00000	2				
RT3115B02500	12	RT5035B00000	2				

Other Products Available From R-Theta Thermal Solutions Inc.

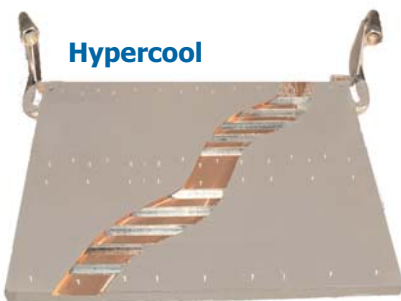

Hypercool

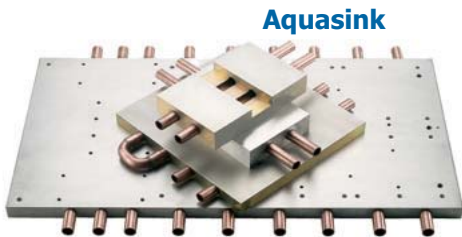

Aquasink

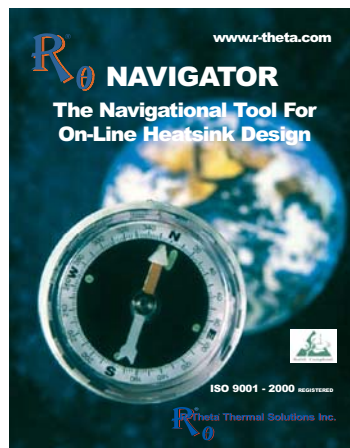

R-theta also offers a complete line of high performance , aluminum and copper alloy heat sinks and AC/DC fans.

Consult R-theta for more details.

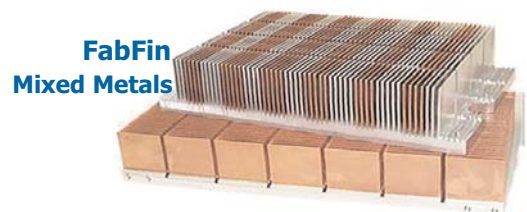

FabFin Mixed Metals

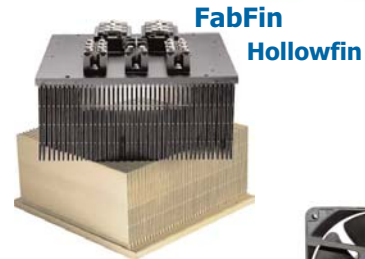

FabFin Hollowfin



AC/DC Fans

R^θ Theta Thermal Solutions Inc.

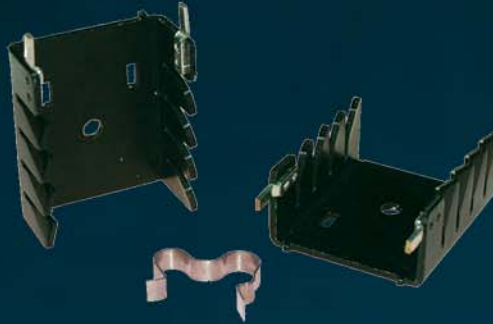
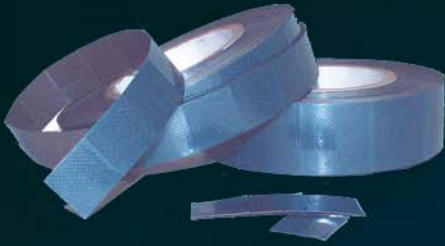
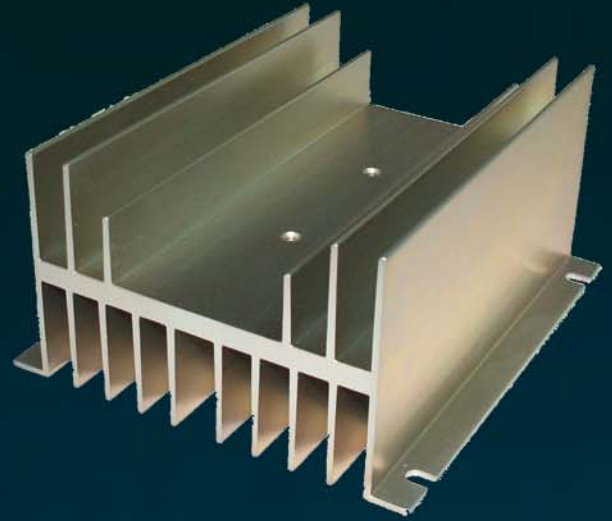

STANDARD Products Catalog

ISO 9001 - 2000 REGISTERED

www.r-theta.com

6220 Kestrel Rd., Mississauga, ON CANADA L5T 1Y9
voice 905.795.0077 fax 905.795.2508 toll free 1.800.388.5428 website www.r-theta.com