

Wide Strap Heavy Duty Cable Ties

The wide strap cable tie minimizes pinching on soft bundles and features a low profile head to provide compact bundling. A thinner strap provides increased flexibility for improved ergonomics.

- Wide strap is designed to minimize pinching of soft hoses and convoluted tubing
- Low profile head
- Clamping rails on the bottom of head to increase grip on round bundles
- Accommodates a large range of bundle diameters:
.375" - 4.125" (9.5mm - 104.7mm)
- Flexible strap
- Bent tip for quick insertion into mounts



Material Data		
Material	Polyamide 6.6 high impact modified, heat stabilized (PA66HIRHS)	
Operating Temperature	-40 °F to +230 °F (-40 °C to +110 °C) continuous	
Flammability	UL94 HB	

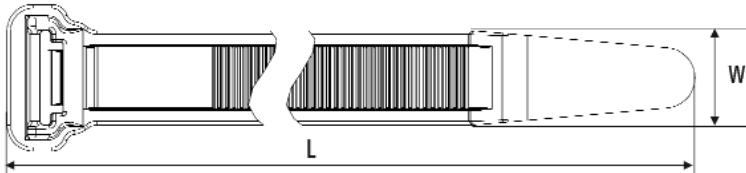

Product Selection		Type	Min. Tensile Strength	Length (L)	Max. Ø Bundle	Width (W)	Color	Pkg. Qty.
Article No.	Part No.		lbs. (N)	in. (mm)	in. (mm)	in. (mm)		
WSS								
111-12303	111-12303	WSS	120 lbs (534)	9.1" (231.14)	2.25" (57.15)	.5" (12.7)	Black	60
111-12300	111-12300	WSS	120 lbs (534)	9.1" (231.14)	2.25" (57.15)	.5" (12.7)	Black	300
WSI								
111-12304	111-12304	WSI	120 lbs (534)	12.1" (307.34)	3.25" (82.55)	.5" (12.7)	Black	60
111-12301	111-12301	WSI	120 lbs (534)	12.1" (307.34)	3.25" (82.55)	.5" (12.7)	Black	300
WSR								
111-12305	111-12305	WSR	120 lbs (534)	15.1" (383.54)	4.125" (104.78)	.5" (12.7)	Black	60
111-12302	111-12302	WSR	120 lbs (534)	15.1" (383.54)	4.125" (104.78)	.5" (12.7)	Black	300

Installation tools - MK9, MK9HT, MK9P. Dimensions are approximate and subject to technical changes. Use **Part No.** for ordering and **Type** for specification purposes.

Heavy Duty Cable Ties T250 Series

These cable ties offer a high minimum tensile strength and have a buckle feature which allows the end of the cable tie to be tucked away if necessary. The buckle also snaps into HellermannTyton LTM, lashing tie mounts.



T250 heavy duty cable tie and lashing tie mount application

Material Data	
Material	Polyamide 6.6 (PA66)
Operating Temperature	-40 °F to +185 °F (-40 °C to +85 °C) continuous
Flammability	UL94 V2

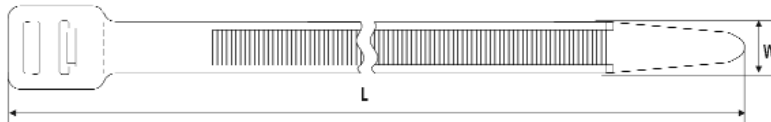

Product Selection		Type	Min. Tensile Strength		Length (L)		Max. Ø Bundle		Width (W)		Color	Pkg. Qty.
Article No.	Part No.		lbs.	(N)	in.	(mm)	in.	(mm)	in.	(mm)		
T250S												
111-24702	T250S9X2	T250S	250 lbs	(1115)	9.05"	(230)	2.17"	(55)	.49"	(12.5)	Natural	25
111-24700	T250S0X2	T250S	250 lbs	(1115)	9.05"	(230)	2.17"	(55)	.49"	(12.5)	Black	25
T250R												
111-24803	T250R9X2	T250R	250 lbs	(1115)	20.47"	(520)	5.71"	(145)	.49"	(12.5)	Natural	25
111-24801	T250R0X2	T250R	250 lbs	(1115)	20.47"	(520)	5.71"	(145)	.49"	(12.5)	Black	25
T250M												
111-25002	T250M9X2	T250M	250 lbs	(1115)	22.24"	(565)	5.90"	(150)	.49"	(12.5)	Natural	25
111-25001	T250M0X2	T250M	250 lbs	(1115)	22.24"	(565)	5.90"	(150)	.49"	(12.5)	Black	25
T250I												
111-25219	T250I9X2	T250I	250 lbs	(1115)	28.54"	(725)	8.00"	(203)	.49"	(12.5)	Natural	25
111-00507	T250I0X2	T250I	250 lbs	(1115)	28.54"	(725)	8.00"	(203)	.49"	(12.5)	Black	25
T250L												
111-00436	T250L9X2	T250L	250 lbs	(1115)	34.65"	(880)	10.00"	(254)	.49"	(12.5)	Natural	25
111-24601	T250L0X2	T250L	250 lbs	(1115)	34.65"	(880)	10.00"	(254)	.49"	(12.5)	Black	25
T250XL												
111-00466	T250XL9X2	T250XL	250 lbs	(1115)	40.55"	(1030)	12.00"	(305)	.49"	(12.5)	Natural	25
111-25200	T250XL0X2	T250XL	250 lbs	(1115)	40.55"	(1030)	12.00"	(305)	.49"	(12.5)	Black	25

Installation tools - MK9, MK9HT, MK9P. Dimensions are approximate and subject to technical changes. Use **Part No.** for ordering and **Type** for specification purposes.

Heavy Duty Cable Ties T255 Series

HellermannTyton's T255 series heavy duty cable ties are ideal for bundles requiring a strong cable tie that may also require a higher temperature rating than the T250 series. These ties have a tensile strength of 250 lbs.



Material Data	
Material	Polyamide 6.6 high impact modified, heat stabilized (PA66HIRHS)
Operating Temperature	-40 °F to +230 °F (-40 °C to +110 °C) continuous
Flammability	UL94 HB

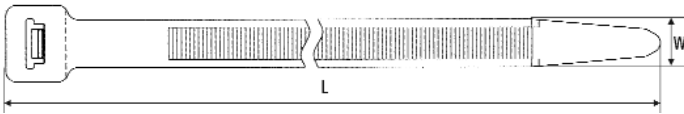

Product Selection			Min. Tensile Strength	Length (L)	Max. Ø Bundle	Width (W)	Color	Pkg. Qty.
Article No.	Part No.	Type						
111-25500	T255S0HIRX2	T255S	250 lbs (1115)	8.86" (225)	2.16" (55)	.49" (12.5)	Black	25
111-25400	T255R0HIRX2	T255R	250 lbs (1115)	20.28" (520)	5.71" (145)	.49" (12.5)	Black	25
111-25300	T255M0HIRX2	T255M	250 lbs (1115)	22.05" (565)	6.30" (160)	.49" (12.5)	Black	25

Installation tools - MK9, MK9HT, MK9P. Dimensions are approximate and subject to technical changes. Use **Part No.** for ordering and **Type** for specification purposes.

Button Head Ties

The button head tie is a two piece tie providing for parallel entry and exit through the head. The strap contains serrations on both sides and has two opposed pawls recessed within a domed head.

This design allows the strap to be directed clockwise or counter-clockwise prior to insertion into the head, enabling bi-directional looping.



New and Improved Features

The button head tie offers many new and improved features for added durability and installation ease.

Standoff tabs — prevent tie head from seating in button during strap insertion

Pilot bushing - protects the strap from abrasion on the mounting hole edge

Ribs - increased ribs added to the bottom of the button head for added durability

Strap - more radiused edges for added flexibility

Serrations - redesigned serrations and wedge design provide optimal strength when seated in the head

Retainers — lower retainers on BT130 help prevent the strap from backing out of the mounting hole and holds HellermannTyton's saddle mounts in place during assembly.

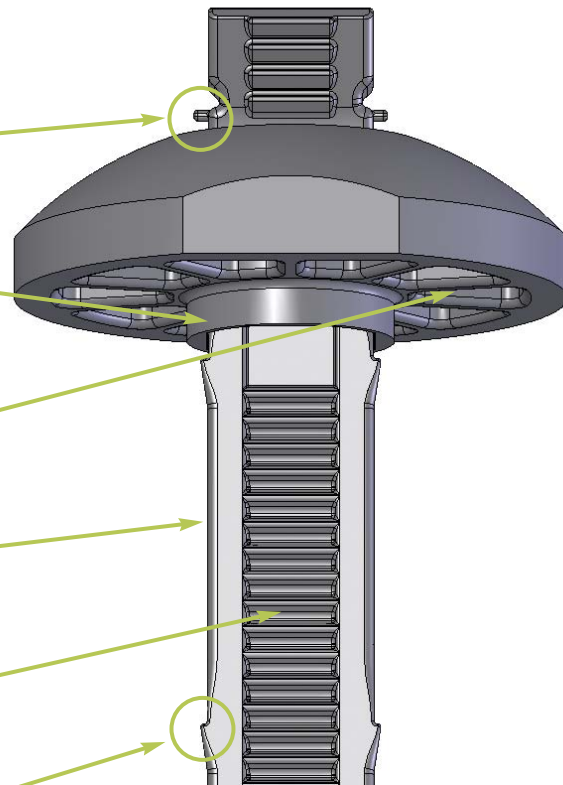

Button Head Ties (continued)

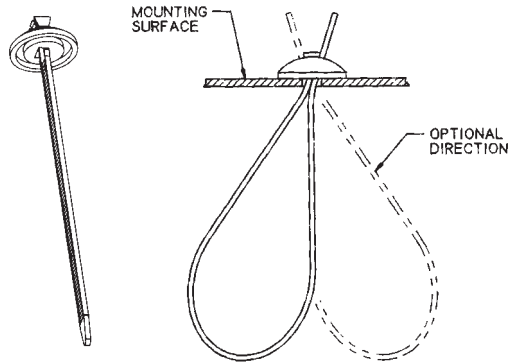

Material Data	
Cable Tie Material	Polyamide 6.6 high impact modified, heat stabilized (PA66HIRHS)
Button Head Material	Polyamide 6.6 heat stabilized (PA66HS)
Operating Temperature	-40 °F to +221 °F (-40 °C to +105 °C) continuous
Color	Black
Flammability	UL94 HB

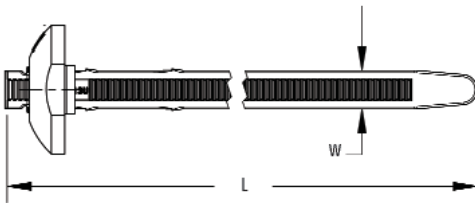

Product Selection			Min. Tensile Strength	Length (L)		Max. Ø Bundle		Width (W)		Color	Pkg. Qty.	
Article No.	Part No.	Type		lbs.	(N)	in.	(mm)	in.	(mm)			in.
BT105 Button Head Ties												
132-00010	132-00010	BT105R	105 lbs	(467)	9.63"	(244.4)	2.62"	(66.7)	.22"	(5.6)	Black	50
132-00011	132-00011	BT105L	105 lbs	(467)	15"	(381.5)	4.33"	(110)	.22"	(5.6)	Black	50
BT105 Button Head Ties with Pilot Bushings												
132-00006	132-00006	BT105RP	105 lbs	(467)	9.63"	(244.4)	2.62"	(66.7)	.22"	(5.6)	Black	50
132-00007	132-00007	BT105LP	105 lbs	(467)	15"	(381.5)	4.33"	(110)	.22"	(5.6)	Black	50
BT130 Button Head Ties with Retainers and Pilot Bushings												
132-00008	132-00008	BT130RDP	130 lbs	(578)	10.51"	(267.0)	2.87"	(73)	.30"	(7.6)	Black	50
132-00009	132-00009	BT130LDP	130 lbs	(578)	15"	(381.5)	4.33"	(110)	.30"	(7.6)	Black	50

Installation tools - MK9, MK9HT, MK9P. Dimensions are approximate and subject to technical changes. Use **Part No.** for ordering and **Type** for specification purposes.

Fir Tree Mount and Cable Tie Assemblies

HellermannTyton's fir tree mounts provide a secure grip in a mounting hole and protect against dirt and other impurities. The mount can slide along the strap of the tie for proper orientation. The fir tree mounts are designed to provide a low insertion force and high extraction force. These mounts are sold as an assembly with the cable tie.



Material Data - All Cable Ties/ FT7, FT8 and FT10 Mounts	
Material	Polyamide 6.6 heat stabilized (PA66HS)
Operating Temperature	-40 °F to +221 °F (-40 °C to +105 °C)
Color	Black
Flammability	UL94 V2



Material Data - FT5, FT6 and FT6LG Mounts	
Material	Polyamide 6.6 high impact modified, heat stabilized (PA66HIRHS)
Operating Temperature	-40 °F to +230 °F (-40 °C to +110 °C)
Color	Black
Flammability	UL94 HB

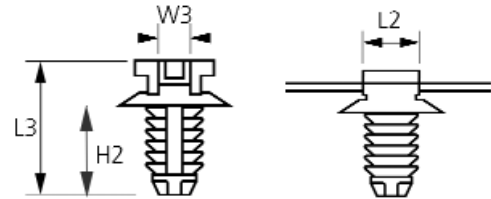
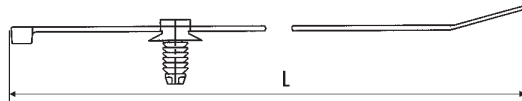

Product Selection

Article No.	Part No.	Type	Min. Tensile Strength lbs. (N)	Max. Ø Bundle in. (mm)	Cable Tie		Mount					Pkg. Qty.
					Length (L) in. (mm)	Width (W) in. (mm)	Disc Ø in. (mm)	Length (L2) in. (mm)	Length (L3) in. (mm)	Width (W3) in. (mm)	Height (H2) in. (mm)	
FT5 - Mounting Hole Ø: .177" - .197" (4.5-5.0mm) - Panel Thickness: .028" - .193" (0.7 - 3.0mm)												
150-55850	150-55850	T30RFT5	30 lbs (135)	1.38" (35)	5.8" (148)	.14" (3.6)	.63" (16.0)	.46" (11.6)	.52" (13.2)	.20" (5)	.27" (6.9)	500
156-00025	156-00025	T50RFT5	50 lbs (225)	1.75" (44.5)	8" (203.2)	.18" (4.6)	.63" (16.0)	.46" (11.6)	.52" (13.2)	.20" (5)	.27" (6.9)	500
FT6 - Mounting Hole Ø: .252" - .28" (6.4-7.1mm) - Panel Thickness: .028" - .193" (0.75 - 3.0mm)												
150-77940	150-77940	T30RFT6	30 lbs (135)	1.38" (35)	5.8" (148)	.14" (3.6)	.63" (16.0)	.46" (11.6)	.54" (13.8)	.20" (5)	.295" (7.5)	500
156-00156	156-00156	T50SFT6	50 lbs (225)	1.38" (35)	6.3" (160)	.18" (4.6)	.63" (16.0)	.46" (11.6)	.54" (13.8)	.20" (5)	.295" (7.5)	500
156-00157	156-00157	T50RFT6	50 lbs (225)	1.75" (44.5)	8" (203.2)	.18" (4.6)	.63" (16.0)	.46" (11.6)	.54" (13.8)	.20" (5)	.295" (7.5)	500
156-00066	156-00066	T50LFT6	50 lbs (225)	4" (101.6)	15" (380)	.18" (4.7)	.63" (16)	.46" (11.6)	.54" (13.8)	.20" (5)	.295" (7.5)	500

Installation tools - MK7, MK7HT, MK7P, MK9, MK9HT, MK9P. Dimensions are approximate and subject to technical changes. Use **Part No.** for ordering and **Type** for specification purposes.

Fir Tree Mount and Cable Tie Assemblies (continued)

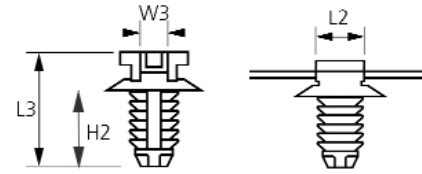
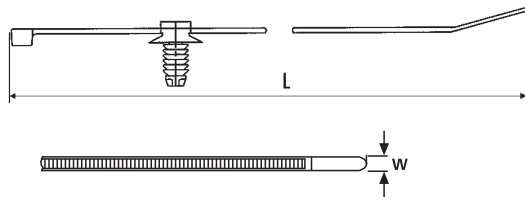

Product Selection												
Article No.	Part No.	Type	Min. Tensile Strength lbs. (N)	Max. Ø Bundle in. (mm)	Cable Tie		Mount					Pkg. Qty.
					Length (L) in. (mm)	Width (W) in. (mm)	Disc Ø in. (mm)	Length (L2) in. (mm)	Length (L3) in. (mm)	Width (W3) in. (mm)	Height (H2) in. (mm)	
FT6LG - Mounting Hole Ø: .256" - .276" (6.4-7.1mm) - Panel Thickness: .03" - .24" (0.75 - 6.0mm)												
150-31090	150-31090	T30RFT6LG	30 lbs (135)	1.38" (35)	5.8" (148)	.14" (3.6)	.63" (16)	.46" (11.6)	.69" (17.5)	.19" (5)	.44" (11.1)	500
150-31093	150-31093	T50SFT6LG	50 lbs (225)	1.38" (35)	6.3" (160)	.18" (4.6)	.63" (16)	.46" (11.6)	.69" (17.5)	.19" (5)	.44" (11.1)	500
150-31091	150-31091	T50RFT6LG	50 lbs (225)	1.75" (44)	8" (203.2)	.18" (4.6)	.63" (16)	.46" (11.6)	.69" (17.5)	.19" (5)	.44" (11.1)	500
156-00054	156-00054	T50IFT6LG	50 lbs (225)	3.35" (85)	11.8" (300)	.18" (4.6)	.63" (16)	.46" (11.6)	.69" (17.5)	.19" (5)	.44" (11.1)	500
FT7 - Mounting Hole Ø: .256" - .276" (6.5-7.0mm) - Panel Thickness: .031" - .276" (0.8 - 7.0mm)												
156-00057	156-00057	T30RFT7	30 lbs (135)	1.38" (35)	5.8" (148)	.14" (3.6)	.63" (16)	.46" (11.6)	.75" (19)	.20" (5)	.5" (12.7)	500
156-00056	156-00056	T50SFT7	50 lbs (225)	1.38" (35)	6.3" (160)	.18" (4.6)	.63" (16)	.46" (11.6)	.75" (19)	.20" (5)	.5" (12.7)	500
111-85871	111-85871	T50RFT7	50 lbs (225)	1.75" (44)	8" (203.2)	.18" (4.6)	.63" (16)	.46" (11.6)	.75" (19)	.20" (5)	.5" (12.7)	500
111-05350	111-05350	T50IFT7	50 lbs (225)	3.35" (85)	11.8" (300)	.18" (4.6)	.63" (16)	.46" (11.6)	.75" (19)	.20" (5)	.5" (12.7)	500
156-00055	156-00055	T50LFT7	50 lbs (225)	4.33" (110)	15" (380)	.18" (4.7)	.63" (16)	.46" (11.6)	.75" (19)	.20" (5)	.5" (12.7)	500
FT8 - Mounting Hole Ø: .3" - .31" (7.7-8.0mm) - Panel Thickness: .03" - .31" (0.8 - 8.0mm)												
156-00058	156-00058	T30RFT8	30 lbs (135)	1.38" (35)	5.8" (148)	.14" (3.6)	.63" (16)	.47" (12.0)	.7" (17.8)	.35" (9)	.45" (11.5)	500
156-00158	156-00158	T50RFT8	50 lbs (225)	1.75" (44)	8" (203.2)	.18" (4.6)	.63" (16)	.47" (12.0)	.7" (17.8)	.35" (9)	.45" (11.5)	500
156-00060	156-00060	T50IFT8	50 lbs (225)	3.35" (81)	11.8" (300)	.18" (4.6)	.63" (16)	.47" (12.0)	.7" (17.8)	.35" (9)	.45" (11.5)	500
156-00061	156-00061	T50LFT8	50 lbs (225)	4.33" (110)	15" (380)	.18" (4.7)	.63" (16)	.47" (12.0)	.7" (17.8)	.35" (9)	.45" (11.5)	500
FT10 - Mounting Hole Ø: .38" - .39" (9.7-10.0mm) - Panel Thickness: .031" - .236" (0.8 - 5.0mm)												
156-00089	156-00089	T30RFT10	30 lbs (135)	1.38" (35)	5.8" (148)	.14" (3.6)	.71" (18)	.47" (12)	.75" (18.6)	.20" (5)	.48" (12.1)	500
156-00090	156-00090	T50SFT10	50 lbs (225)	1.38" (35)	6.3" (160)	.18" (4.6)	.71" (18)	.47" (12)	.75" (18.6)	.20" (5)	.48" (12.1)	500
156-00091	156-00091	T50RFT10	50 lbs (225)	1.75" (44)	8" (203.2)	.18" (4.6)	.71" (18)	.47" (12)	.75" (18.6)	.20" (5)	.48" (12.1)	500
156-00092	156-00092	T50IFT10	50 lbs (225)	3.35" (81)	11.8" (300)	.18" (4.6)	.71" (18.0)	.47" (12)	.75" (18.6)	.20" (5)	.48" (12.1)	500
156-00093	156-00093	T50LFT10	50 lbs (225)	4.33" (110)	15" (380)	.18" (4.7)	.71" (18)	.47" (12)	.75" (18.6)	.20" (5)	.48" (12.1)	500

Installation tools - MK7, MK7HT, MK7P, MK9, MK9HT, MK9P. Dimensions are approximate and subject to technical changes. Use **Part No.** for ordering and **Type** for specification purposes.

Heavy Duty Fir Tree Mounts and Cable Tie Assemblies

Designed specifically for 120 - 250 lb. cable ties, the heavy duty fir tree mounts are optimized for up to 3 to 1 extraction versus insertion force. The "H" profile provides a broad surface contact to minimize the pinching of bundles and will easily hold bundles ranging from 3/8" to 3". Heavy duty fir tree mounts are equipped with a friction tab that will hold the tie in the mount, allowing them to be preassembled prior to installation. These mounts are sold as an assembly with the cable tie.

Material Data	
Material	Polyamide 6.6 high impact modified, heat stabilized (PA66HIRHS)
Operating Temperature	-40 °F to +230 °F (-40 °C to +110 °C) continuous
Flammability	UL94 HB

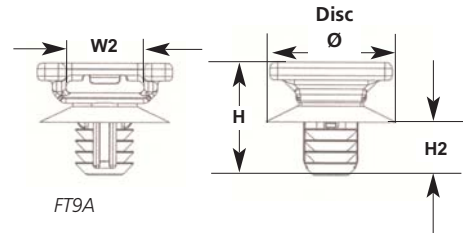
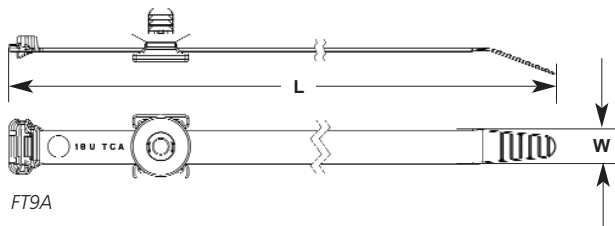

Product Selection											
Article No.	Part No.	Type	Min. Tensile Strength lbs. (N)	Max. Ø Bundle in. (mm)	Cable Tie		Mount				Pkg. Qty.
					Length (L) in. (mm)	Width (W) in. (mm)	Disc Ø in. (mm)	Width (W2) in. (mm)	Height (H) in. (mm)	Height (H2) in. (mm)	
FT9A - Mounting Hole Ø: .343" - .363" (8.75 - 9.25mm) - Panel Thickness: .04" - .26" (1.0 - 6.5mm)											
156-00067	T120RFT9A0ZC2	T120RFT9A	120 lbs (534)	4" (101.6)	15.25" (387.4)	.30" (7.6)	.85" (21.6)	.51" (13)	.75" (19.1)	.36" (9)	100
156-00068	WSSFT9A0ZC2	WSSFT9A	120 lbs (534)	2.25" (57.1)	9" (228.6)	.50" (12.7)	.85" (21.6)	.51" (13)	.75" (19.1)	.36" (9)	100
156-00069	WSIFT9A0ZC2	WSIFT9A	120 lbs (534)	3.25" (82.5)	12" (304.8)	.50" (12.7)	.85" (21.6)	.51" (13)	.75" (19.1)	.36" (9)	100
156-00070	WSRFT9A0ZC2	WSRFT9A	120 lbs (534)	4.13" (104.8)	15" (381)	.50" (12.7)	.85" (21.6)	.51" (13)	.75" (19.1)	.36" (9)	100

Installation tools - MK7, MK7HT, MK7P, MK9, MK9HT, MK9P. Dimensions are approximate and subject to technical changes. Use **Part No.** for ordering and **Type** for specification purposes.

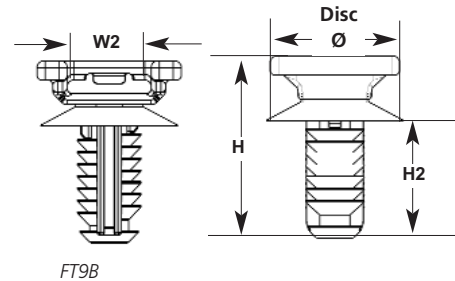
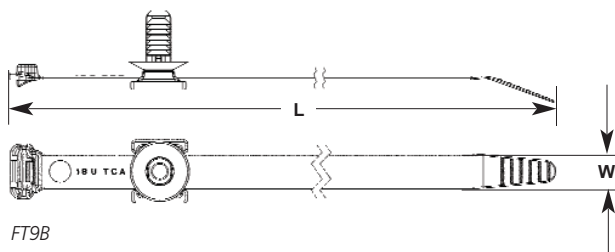

Product Selection											
Article No.	Part No.	Type	Min. Tensile Strength lbs. (N)	Max. Ø Bundle in. (mm)	Cable Tie		Mount				Pkg. Qty.
					Length (L) in. (mm)	Width (W) in. (mm)	Disc Ø in. (mm)	Width (W2) in. (mm)	Height (H) in. (mm)	Height (H2) in. (mm)	
FT9B - Mounting Hole Ø: .343" - .363" (8.75 - 9.25mm) - Panel Thickness: .04" - .62" (1.0 - 15.8 mm)											
156-00071	T120RFT9B0ZC2	T120RFT9B	120 lbs (534)	4" (101.6)	15.25" (387.4)	.30" (7.6)	.85" (21.6)	.51" (13)	1.12" (28.4)	.73" (18.4)	100
156-00072	WSSFT9B0ZC2	WSSFT9B	120 lbs (534)	2.25" (57.1)	9" (228.6)	.50" (12.7)	.85" (21.6)	.51" (13)	1.12" (28.4)	.73" (18.4)	100
156-00073	WSIFT9B0ZC2	WSIFT9B	120 lbs (534)	3.25" (82.5)	12" (304.8)	.50" (12.7)	.85" (21.6)	.51" (13)	1.12" (28.4)	.73" (18.4)	100
156-00074	WSRFT9B0ZC2	WSRFT9B	120 lbs (534)	4.13" (104.8)	15" (381)	.50" (12.7)	.85" (21.6)	.51" (13)	1.12" (28.4)	.73" (18.4)	100

Installation tools - MK7, MK7HT, MK7P, MK9, MK9HT, MK9P. Dimensions are approximate and subject to technical changes. Use **Part No.** for ordering and **Type** for specification purposes.

Fir Tree Push Mount Ties

Fir tree design grips to the inside of a hole. They can be used on sheet metal, wood, and cast iron. Type T50RTM25E has a longer fir tree for larger panel thicknesses.

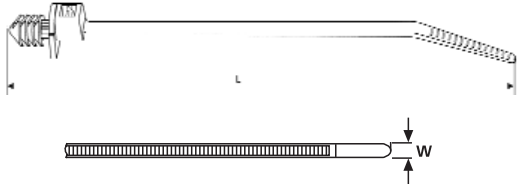

Material Data	
Material	Polyamide 6.6 heat stabilized (PA66HS)
Operating Temperature	-40 °F to +221 °F (-40 °C to +105 °C) continuous
Flammability	UL94 V2



Product Selection			Min. Tensile Strength	Mounting Hole Ø	Panel Thickness	Length (L)	Max. Ø Bundle	Width (W)	Color	Pkg. Qty.
Article No.	Part No.	Type								
126-03501	T50RTM250HSM4	T50RTM25	50 lbs (225)	.25" - .26" (6.5 - 6.6)	.052" - .28" (1.32 - 7.0)	8.27" (210)	1.97" (50.0)	.19" (4.7)	Black	1000
157-01400	T50RTM25E8HSM4	T50RTM25E	50 lbs (225)	.25" - .26" (6.5 - 6.6)	.09" - .55" (2.3 - 13.94)	8.43" (214)	1.97" (50.0)	.19" (4.7)	Gray	1000

Installation tools - MK7, MK7HT, MK7P, MK9, MK9HT, MK9P. Dimensions are approximate and subject to technical changes. Use **Part No.** for ordering and **Type** for specification purposes.

Fir Tree Mount with Disc Tie

This fir tree mount tie provides a low insertion force with a high extraction force. The outside serrations present a smooth surface to the cables preventing damage to the insulation. The unique head design allows the cable tie to firmly hold bundles as small as .06" diameter and the disc offers added water protection.

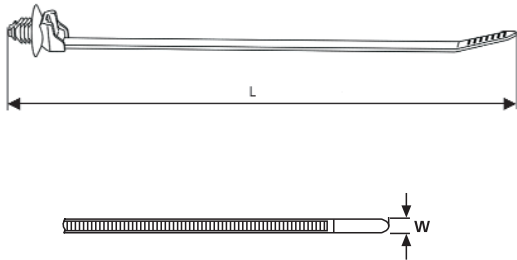

Material Data	
Material	Polyamide 6.6 high impact modified, heat stabilized (PA66HIRHS)
Operating Temperature	-40 °F to +230 °F (-40 °C to +110 °C) continuous
Flammability	UL94 HB



Product Selection			Min. Tensile Strength	Mounting Hole Ø	Panel Thickness	Length (L)	Max. Ø Bundle	Width (W)	Color	Pkg. Qty.
Article No.	Part No.	Type								
155-05800	155-05800	T50SOSFT6E	50 lbs (225)	.26" - .28" (6.5-7.0)	.03" - .12" (0.75 - 3.0)	6.30" (160)	1.38" (35)	.18" (4.6)	Black	500

Installation tools - MK7, MK7HT, MK7P, MK9, MK9HT, MK9P. Dimensions are approximate and subject to technical changes. Use **Part No.** for ordering and **Type** for specification purposes.

Domed Fir Tree Mount

The domed head tie provides a tight, rattle-free installation and the outside serrated strap has ribs designed for convoluted tubing. The dome also acts as a seal to keep out dust and liquid.



Material Data	
Material	Polyamide 6.6 heat stabilized (PA66HS)
Operating Temperature	-40 °F to +221 °F (-40 °C to +105 °C) continuous
Flammability	UL94 V2

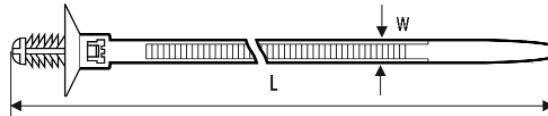

Product Selection											
Article No.	Part No.	Type	Min. Tensile Strength		Mounting Hole Ø	Panel Thickness	Length (L)	Max. Ø Bundle	Width (W)	Color	Pkg. Qty.
			lbs.	(N)	in. (mm)	in. (mm)	in. (mm)	in. (mm)	in. (mm)		
157-01100	T50SDP6.HB6P	T50SDP6	45 lbs	(200)	.25" - .28" (6.3-7.0)	.03" - .28" (0.8 - 7.0)	6.69" (170)	1.22" (31)	.20" (5.1)	Black	500

Installation tools - MK7, MK7HT, MK7P, MK9, MK9HT, MK9P. Dimensions are approximate and subject to technical changes. Use **Part No.** for ordering and **Type** for specification purposes.

Domed Push Mount Tie

The domed head tie provides a tight, rattle-free installation and the outside serrated strap has ribs designed for convoluted tubing. The dome also acts as a seal to keep out dust and liquid.



Material Data	
Material	Polyamide 6.6 heat stabilized (PA66HS)
Operating Temperature	-40 °F to +221 °F (-40 °C to +105 °C) continuous
Flammability	UL94 V2

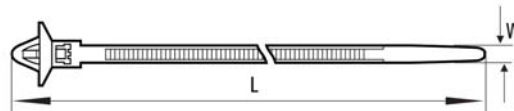

Product Selection											
Article No.	Part No.	Type	Min. Tensile Strength		Mounting Hole Ø	Panel Thickness	Length (L)	Max. Ø Bundle	Width (W)	Color	Pkg. Qty.
			lbs.	(N)	in. (mm)	in. (mm)	in. (mm)	in. (mm)	in. (mm)		
111-85350	111-85350	T50SD6	50 lbs	(225)	.25" - .30" (6.3-7.5)	.023" - .047" (0.6 - 1.2)	6.30" (160)	1.22" (31)	.20" (5.1)	Black	500

Installation tools - MK7, MK7HT, MK7P, MK9, MK9HT, MK9P. Dimensions are approximate and subject to technical changes. Use **Part No.** for ordering and **Type** for specification purposes.

Push Mount Ties

One-piece, all plastic ties for quick, simple cable mounting.



Material Data	
Material	Polyamide 6.6 (PA66)
Operating Temperature	-40 °F to +185 °F (-40 °C to +85 °C) continuous
Flammability	UL94 V2



CFI US
File# E64139

Product Selection

Article No.	Part No.	Type	Min. Tensile Strength		Mounting Hole Ø	Panel Thickness	Length (L)	Max. Ø Bundle	Width (W)	Color	Pkg. Qty.
			lbs.	(N)	in. (mm)	in. (mm)	in. (mm)	in. (mm)	in. (mm)		
T30RSF											
111-85603	T30RSF9C2	T30RSF(U)	30 lbs	(135)	.19" - .22" (4.76-5.59)	.04" - .09" (0.9-2.36)	6.34" (161)	1.25" (31.8)	.14" (3.6)	Natural	100
126-00704	T30RSF9M4	T30RSF(U)	30 lbs	(135)	.19" - .22" (4.76-5.59)	.04" - .09" (0.9-2.36)	6.34" (161)	1.25" (31.8)	.14" (3.6)	Natural	1000
126-00700	T30RSF0C2	T30RSF(U)	30 lbs	(135)	.19" - .22" (4.76-5.59)	.04" - .09" (0.9-2.36)	6.34" (161)	1.25" (31.8)	.14" (3.6)	Black	100
126-00702	T30RSF0M4	T30RSF(U)	30 lbs	(135)	.19" - .22" (4.76-5.59)	.04" - .09" (0.9-2.36)	6.34" (161)	1.25" (31.8)	.14" (3.6)	Black	1000
T50SSF											
126-00043	126-00043	T50SSF	50 lbs	(225)	.25" - .28" (6.4-7.1)	.04" - .14" (1.0-3.56)	6.26" (159)	1.38" (35)	.19" (4.7)	Natural	100
126-00044	126-00044	T50SSF	50 lbs	(225)	.25" - .28" (6.4-7.1)	.04" - .14" (1.0-3.56)	6.26" (159)	1.38" (35)	.19" (4.7)	Natural	1000
126-00045	126-00045	T50SSF	50 lbs	(225)	.25" - .28" (6.4-7.1)	.04" - .14" (1.0-3.56)	6.26" (159)	1.38" (35)	.19" (4.7)	Black	100
126-00046	126-00046	T50SSF	50 lbs	(225)	.25" - .28" (6.4-7.1)	.04" - .14" (1.0-3.56)	6.26" (159)	1.38" (35)	.19" (4.7)	Black	1000
T50RSF											
111-85789	T50RSF9C2	T50RSF(U)	50 lbs	(225)	.25" - .28" (6.4-7.1)	.04" - .14" (1.0-3.56)	8.27" (210)	1.73" (44)	.19" (4.7)	Natural	100
126-01011	T50RSF9M4	T50RSF(U)	50 lbs	(225)	.25" - .28" (6.4-7.1)	.04" - .14" (1.0-3.56)	8.27" (210)	1.73" (44)	.19" (4.7)	Natural	1000
126-01003	T50RSF0C2	T50RSF(U)	50 lbs	(225)	.25" - .28" (6.4-7.1)	.04" - .14" (1.0-3.56)	8.27" (210)	1.73" (44)	.19" (4.7)	Black	100
126-01004	T50RSF0M4	T50RSF(U)	50 lbs	(225)	.25" - .28" (6.4-7.1)	.04" - .14" (1.0-3.56)	8.27" (210)	1.73" (44)	.19" (4.7)	Black	1000

Installation tools - MK7, MK7HT, MK7P, MK9, MK9HT, MK9P. Dimensions are approximate and subject to technical changes. Use **Part No.** for ordering and **Type** for specification purposes.

Wing Push Mount Ties

Wing design helps stabilize the tie in high vibration applications. They can be used on sheet metal, wood, and cast iron.



Material Data	
Material	Polyamide 6.6 (PA66)
Operating Temperature	-40 °F to +185 °F (-40 °C to +85 °C) continuous
Flammability	UL94 V2



Material Data	
Material	Polyamide 6.6 high impact modified, heat stabilized (PA66HIRHS)
Operating Temperature	-40 °F to +230 °F (-40 °C to +110 °C) continuous
Flammability	UL94 HB



Material Data	
Material	Polyamide 6.6 heat stabilized (PA66HS)
Operating Temperature	-40 °F to +221 °F (-40 °C to +105 °C) continuous
Flammability	UL94 V2

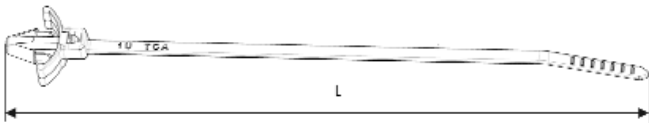

Product Selection

Article No.	Part No.	Type	Min. Tensile Strength	Mounting Hole Ø	Panel Thickness	Length (L)	Max. Ø Bundle	Width (W)	Color	Material	Pkg. Qty.
			lbs. (N)	in. (mm)	in. (mm)						
T18RWPM											
126-00041	126-00041	T18RWPM	18 lbs (80)	.19" - .22" (4.76-5.59)	.07" - .13" (1.85 - 3.18)	4.45" (113)	.87" (22)	.10" (2.5)	Natural	PA66	100
126-00603	T18RWPM9M4	T18RWPM	18 lbs (80)	.19" - .22" (4.76-5.59)	.07" - .13" (1.85 - 3.18)	4.45" (113)	.87" (22)	.10" (2.5)		PA66	1000
126-00042	126-00042*	T18RWPM	18 lbs (80)	.19" - .22" (4.76-5.59)	.07" - .13" (1.85 - 3.18)	4.45" (113)	.87" (22)	.10" (2.5)	Black	PA66HS	1000
T50SSF											
126-00049	T50SSF	T50SSF	50 lbs (225)	.24" - .25" (6.0 - 6.4)	.04" - .12" (1.0 - 3.0)	5.71" (145)	.98" (25)	.19" (4.7)	Black	PA66HIRHS	500
T50SL6											
111-85469	T50SL6.NN6P	T50SL6	50 lbs (225)	.24" - .26" (6.1 - 6.5)	.03" - .10" (0.8 - 2.5)	6.50" (165)	1.34" (34)	.18" (4.6)	Natural	PA66	500
T50SL7											
111-85479	T50SL7.NN6P	T50SL7	50 lbs (225)	.27" - .28" (6.9 - 7.1)	.03" - .10" (0.8 - 2.5)	6.50" (165)	1.34" (34)	.18" (4.6)	Natural	PA66	500

Installation tools - MK7, MK7HT, MK7P, MK9, MK9HT, MK9P. Dimensions are approximate and subject to technical changes. Use **Part No.** for ordering and **Type** for specification purposes. UL recognition applies to T18RWPM ties.

* UL listing applies to 126-00042.

Arrowhead Mount Ties with Seal

The arrowhead design of these ties offers a positive, low insertion force and a high extraction force. These ties feature a foam rubber seal which provides additional protection against moisture, dirt and other impurities.



Material Data	
Material	Polyamide 6.6 heat stabilized (PA66HS)
Operating Temperature	-40 °F to +221 °F (-40 °C to +105 °C) continuous
Flammability	UL94 V2

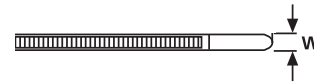
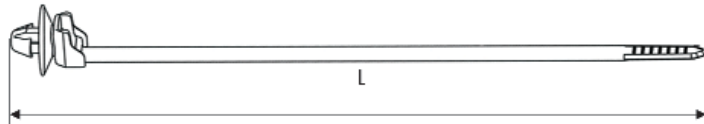

Product Selection		Type	Min. Tensile Strength		Mounting Hole Ø	Panel Thickness	Length (L)	Max. Ø Bundle	Width (W)	Color	Pkg. Qty.
Article No.	Part No.		lbs. (N)	in. (mm)	in. (mm)	in. (mm)	in. (mm)	in. (mm)			
126-03100	126-03100	T50SOSSFT6.5E-MD	50 lbs (225)	.25" - .26" (6.3-6.7)	.02" - .07" (0.6 - 1.8)	6.30" (160)	1.38" (35)	.18" (4.6)	Green	500	
156-00264	156-00264	T50SOSSFT6.5E-MD	50 lbs (225)	.25" - .26" (6.3-6.7)	.02" - .07" (0.6 - 1.8)	6.30" (160)	1.38" (35)	.18" (4.6)	Black	500	

Installation tools - MK7, MK7HT, MK7P, MK9, MK9HT, MK9P. Dimensions are approximate and subject to technical changes. Use **Part No.** for ordering and **Type** for specification purposes.

Center Mount, Domed Push Mount Ties

The center mount, domed push mount tie centers the mount on all bundle diameters. The mount is molded in a stationary position for easy assembly. A tab extends beyond the head for easy strap insertion.

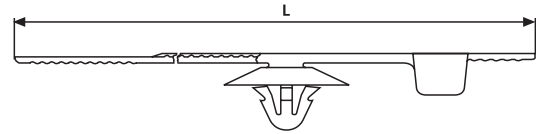

Material Data	
Material	Polyamide 6.6 (PA66)
Operating Temperature	-40 °F to +185 °F (-40 °C to +85 °C) continuous
Flammability	UL94 V2



Product Selection

Article No.	Part No.	Type	Min. Tensile Strength	Mounting Hole Ø	Panel Thickness	Length (L)	Max. Ø Bundle	Width (W)	Color	Pkg. Qty.
			lbs. (N)	in. (mm)	in. (mm)	in. (mm)	in. (mm)	in. (mm)		
150-35930	150-35930	T50RSP	50 lbs (222)	.24" - .26" (6.0-6.5)	.03" - .05" (0.75 - 1.3)	7.48" (190)	1.77" (45)	.18" (4.6)	Black	1000

Installation tools - MK7, MK7HT, MK7P, MK9, MK9HT, MK9P. Dimensions are approximate and subject to technical changes. Use **Part No.** for ordering and **Type** for specification purposes.

Ladder Style Push Mount Ties

The unique ladder style design eliminates the need for various sizes of clamps and allows for easy re-entry to access bundle. Wings on the side of the tie provide stabilization.

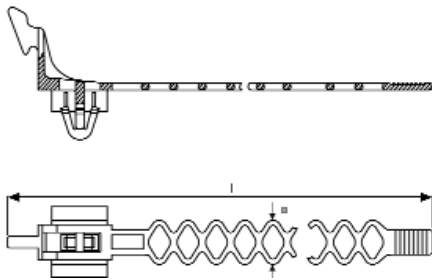

Material Data	
Material	Polyamide 6.6 (PA66)
Operating Temperature	-40 °F to +185 °F (-40 °C to +85 °C) continuous
Flammability	UL94 V2



Product Selection

Article No.	Part No.	Type	Mounting Hole Ø	Panel Thickness	Length (L)	Max. Ø Bundle	Width (W)	Color	Pkg. Qty.
			in. (mm)	in. (mm)	in. (mm)	in. (mm)	in. (mm)		
150-26100	FBS1000H4	FBS100	.25" - .26" (6.3-6.7)	.03" - .15" (0.7 - 3.9)	4.53" (115)	1.06" (27)	.40" (10)	Black	500
150-26140	FBS1400H4	FBS140	.26" - .25" (6.3-6.7)	.03" - .15" (0.7 - 3.9)	6.30" (160)	1.65" (42)	.40" (10)	Black	500
150-26180	FBS1850H4	FBS185	.26" - .25" (6.3-6.7)	.03" - .15" (0.7 - 3.9)	7.87" (200)	2.09" (53)	.40" (10)	Black	500

Installation tools - MK7, MK7HT, MK7P, MK9, MK9HT, MK9P. Dimensions are approximate and subject to technical changes. Use **Part No.** for ordering and **Type** for specification purposes.

Wide Strap Heavy Duty Stud Mount Cable Ties

The wide strap stud mount cable tie minimizes pinching on soft bundles and features a low profile head to provide compact bundling. A thinner strap provides increased flexibility for improved ergonomics. Available with a 1/4" and 3/8" stud mount, the wide strap tie utilizes a strong hinge between the stud mount and head to provide superior holding ability on a threaded stud.

- Wide strap to minimize pinching of soft hoses and convoluted tubing
- Clamping rails to increase grip on round bundles
- Wide variation of bundle diameters: .375" - 4.125" (9.5mm - 104.7mm)
- Flexible strap
- Flexible hinge
- Mount provides low insertion and high extraction forces

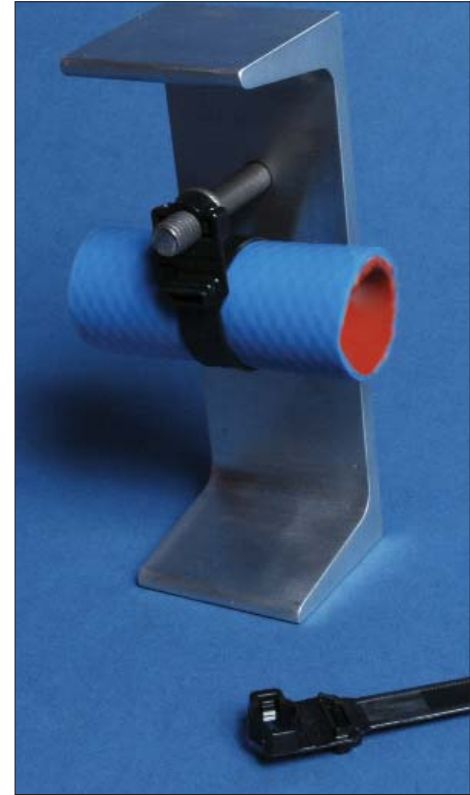

Material Data	
Material	Polyamide 6.6 high impact modified, heat stabilized (PA66HIRHS)
Operating Temperature	-40 °F to +230 °F (-40 °C to +110 °C) continuous
Flammability	UL94 HB

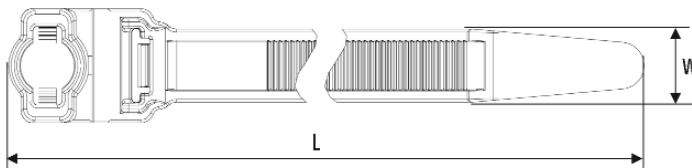

Product Selection			Min. Tensile Strength	Length (L)	Max. Ø Bundle	Width (W)	Color	Pkg. Qty.
Article No.	Part No.	Type						
Wide Strap Ties with 1/4" Stud Mount								
157-00400	157-00400	WSS250	120 lbs (534)	9.7" (246.38)	2.25" (57.15)	.5" (12.7)	Black	300
157-00401	157-00401	WSI250	120 lbs (534)	12.7" (322.58)	3.25" (82.55)	.5" (12.7)	Black	300
157-00402	157-00402	WSR250	120 lbs (534)	15.7" (398.78)	4.125" (104.78)	.5" (12.7)	Black	300
Wide Strap Ties with 3/8" Stud Mount								
WSS38								
157-00406	157-00406	WSS380	120 lbs (534)	9.7" (246.38)	2.25" (57.15)	.5" (12.7)	Black	60
157-00403	157-00403	WSS380	120 lbs (534)	9.7" (246.38)	2.25" (57.15)	.5" (12.7)	Black	300
WSI38								
157-00407	157-00407	WSI380	120 lbs (534)	12.7" (322.58)	3.25" (82.55)	.5" (12.7)	Black	60
157-00404	157-00404	WSI380	120 lbs (534)	12.7" (322.58)	3.25" (82.55)	.5" (12.7)	Black	300
WSR38								
157-00408	157-00408	WSR380	120 lbs (534)	15.7" (398.78)	4.125" (104.78)	.5" (12.7)	Black	60
157-00405	157-00405	WSR380	120 lbs (534)	15.7" (398.78)	4.125" (104.78)	.5" (12.7)	Black	300

Installation tools - MK9, MK9HT, MK9P. Dimensions are approximate and subject to technical changes. Use **Part No.** for ordering and **Type** for specification purposes.

Stud Mount Ties

The stud mount tie mounts and secures a cable bundle in one component. The stud mount tie is designed for use on a 1/4" - 20 UNC threaded stud or the exposed threads of a machine screw.

Material Data	
Material	Polyamide 6.6 high impact modified, heat stabilized (PA66HIRHS)
Operating Temperature	-40 °F to +230 °F (-40 °C to +110 °C) continuous
Flammability	UL94 HB



Product Selection			Stud Ø	Min. Tensile Strength	Length (L)	Max. Ø Bundle	Width (W)	Color	Pkg. Qty.
Article No.	Part No.	Type							
157-01300	T120RSM0HIRK2	T120RSM	.25" (6.25)	120 lbs (535)	15.94" (405)	3.98" (101)	.30" (7.6)	Black	50

Installation tools - MK9, MK9HT, MK9P. Dimensions are approximate and subject to technical changes. Use **Part No.** for ordering and **Type** for specification purposes.

Standoff Stud Mount Tie

This tie is easily mounted on the top of the stud, and the additional height gained by this design gives the bundle added clearance from the panel.

Material Data	
Material	Polyamide 6.6 heat stabilized (PA66HS)
Operating Temperature	-40 °F to +221 °F (-40 °C to +105 °C) continuous
Flammability	UL94 V2

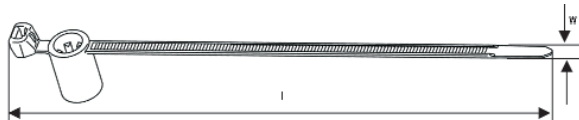

Product Selection			Stud Ø	Min. Tensile Strength	Length (L)	Max. Ø Bundle	Width (W)	Color	Pkg. Qty.
Article No.	Part No.	Type							
155-30602	155-30602	T50SSBS50TE	.20" (5)	45 lbs (200)	6.30" (160)	1.38" (35)	.181" (4.6)	Black	500

Installation tools - MK7, MK7HT, MK7P, MK9, MK9HT, MK9P. Dimensions are approximate and subject to technical changes. Use **Part No.** for ordering and **Type** for specification purposes.

Oval Shaped Variable Stud Mount Ties

The special oval shape provides for an approximate .20" (5.5mm) lateral adjustment, allowing for any misalignment of the stud or incorrect positioning of the tie on the cables. The "soft push" mount allows it to be installed onto a weld stud without the use of any tools.

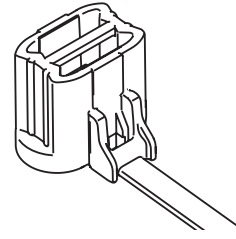

T50SOSSB5HEC

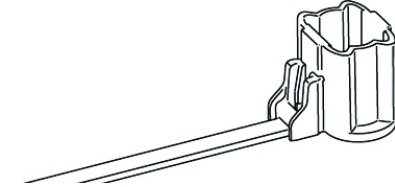

T50SOSSB6HE

Material Data	
Material	Polyamide 6.6 heat stabilized (PA66HS)
Operating Temperature	-40 °F to +221 °F (-40 °C to +105 °C) continuous
Flammability	UL94 V2



Product Selection			Stud Ø		Min. Tensile Strength		Length (L)		Max. Ø Bundle		Width (W)		Color	Pkg. Qty.
Article No.	Part No.	Type	in.	(mm)	lbs.	(N)	in.	(mm)	in.	(mm)	in.	(mm)		
155-05400	155-05400	T50SOSSB5HEC	.20"	(5)	38 lbs	(170)	6.30"	(160)	1.38"	(35)	.18"	(4.6)	Black	500
155-46302	155-46302	T50SOSSB6HE	.24"	(6)	38 lbs	(170)	6.30"	(160)	1.38"	(35)	.18"	(4.6)	Black	500

Installation tools - MK7, MK7HT, MK7P, MK9, MK9HT, MK9P. Dimensions are approximate and subject to technical changes. Use **Part No.** for ordering and **Type** for specification purposes.

Stud Mount Tie with Outside Serrations

Providing an especially secure hold and the ability to mount the cables very close to the stud, this tie is outside serrated preventing damage to the insulation of the cable.

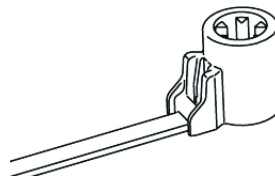

T50SOSSB5SE

Material Data	
Material	Polyamide 6.6 heat stabilized (PA66HS)
Operating Temperature	-40 °F to +221 °F (-40 °C to +105 °C) continuous
Flammability	UL94 V2



Product Selection			Stud Ø		Min. Tensile Strength		Length (L)		Max. Ø Bundle		Width (W)		Color	Pkg. Qty.
Article No.	Part No.	Type	in.	(mm)	lbs.	(N)	in.	(mm)	in.	(mm)	in.	(mm)		
155-12300	155-12300	T50SOSSB5SE	.20"	(5)	50 lbs	(225)	6.30"	(160)	1.38"	(35)	.18"	(4.6)	Black	500

Installation tools - MK7, MK7HT, MK7P, MK9, MK9HT, MK9P. Dimensions are approximate and subject to technical changes. Use **Part No.** for ordering and **Type** for specification purposes.

Flexible Head Stud Mount Tie

Flexible head wraps around cable bundle for easy installation. Tie mounts onto #10-24" stud.



Material Data	
Material	Polyamide 6.6 (PA66)
Operating Temperature	-40 °F to +185 °F (-40 °C to +85 °C) continuous
Flammability	UL94 V2

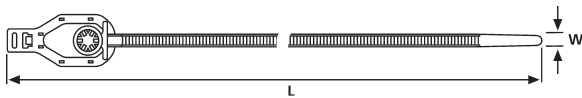

Product Selection			Stud Ø	Min. Tensile Strength	Length (L)	Max. Ø Bundle	Width (W)	Color	Pkg. Qty.
Article No.	Part No.	Type							
111-07110	T50RS5.NB3P	T50RS5	#10-24"	50 lbs (225)	7.5" (190)	1.5" (40)	.18" (4.6)	Black	100

Installation tools - MK7, MK7HT, MK7P, MK9, MK9HT, MK9P. Dimensions are approximate and subject to technical changes. Use **Part No.** for ordering and **Type** for specification purposes.

Stud Mount Tie with Disc

Offering the opportunity to retain both insulation material and cable bundles with one product, this cable tie can be installed onto a weld stud without the use of any tools. The unique head design allows the cable tie to firmly hold bundles as small as .062" (1.6 mm) in diameter.



The new head design offers a secure mount on soft materials.

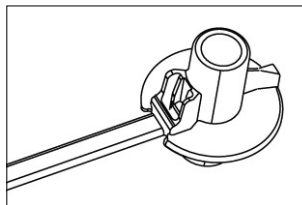

Product Selection			Stud Ø	Min. Tensile Strength	Length (L)	Max. Ø Bundle	Width (W)	Color	Pkg. Qty.
Article No.	Part No.	Type							
155-30602	155-30602	T50SSBS50TE	.20" (5)	45 lbs (200)	6.30" (160)	1.38" (35)	.181" (4.6)	Black	500

Installation tools - MK7, MK7HT, MK7P, MK9, MK9HT, MK9P. Dimensions are approximate and subject to technical changes. Use **Part No.** for ordering and **Type** for specification purposes.

Stud Mount Lateral Adjustment Tie

The special shape of this mount provides a .20" (5-6 mm) lateral adjustment to allow for any misalignment of the stud or incorrect positioning of the tie on the cables. The low profile of the mount allows for several ties to be installed one-on-top of the other (on the same stud) to accommodate different cable bundles.



T50S0SWSP5E, parallel installation using two stud mount lateral ties.

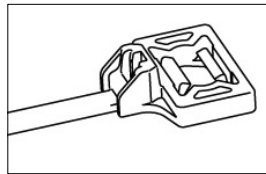

Material Data	
Material	Polyamide 6.6 heat stabilized (PA66HS)
Operating Temperature	-40 °F to +221 °F (-40 °C to +105 °C) continuous
Flammability	UL94 V2



Product Selection			Stud Ø	Min. Tensile Strength	Length (L)	Max. Ø Bundle	Width (W)	Color	Pkg. Qty.
Article No.	Part No.	Type							
155-23601	155-23601	T50S0SWSP5E	.20" (5)	50 lbs (225)	6.35" (163)	1.4" (35)	.18" (4.6)	Black	500

Installation tools - MK7, MK7HT, MK7P, MK9, MK9HT, MK9P. Dimensions are approximate and subject to technical changes. Use **Part No.** for ordering and **Type** for specification purposes.

Cable Ties and Edge Clips

HellermannTyton's edge clips are designed specifically to route bundles by securing them to the edge of a plastic or metal sheet without the need for a mounting hole. The clip is easy to secure and the extraction force is high due to the integrated metal clamp that holds the edge clip in place. Edge clips are available in three configurations: a two piece clip and tie assembly, a one piece clip and tie combination and a edge clip and tape bar combination. When noted (*), cable ties are outside serrated which can reduce bundle chafing.

Two Piece Edge Clip and Cable Tie Assemblies

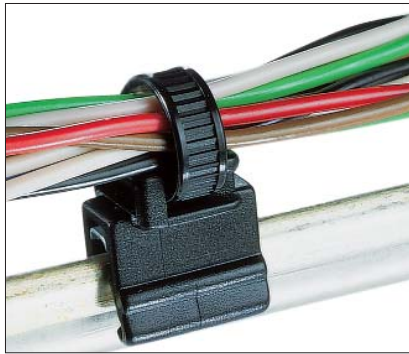

T50ROSEC4A - the cable bundle runs parallel with the edge.

Material Data- Cable Tie		RoHS
Material	Polyamide 6.6 heat stabilized (PA66HS)	
Color	Black	
Operating Temperature	-40 °F to +221 °F (-40 °C to +105 °C) continuous	
Flammability	UL94 V2	

Material Data - Edge Clip		RoHS
Material	Polyamide 6.6 high impact modified, heat stabilized (PA66HIRHS)	
Color	Black	
Operating Temperature	-40 °F to +230 °F (-40 °C to +110 °C) continuous	
Flammability	UL94 HB	

Article No.	Part No.	Type	Min. Tensile Strength		Length (L) in. (mm)	Max. Ø Bundle in. (mm)	Pkg. Qty.	Drawing
			lbs.	(N)				
Panel Thickness, — .039" - .117" (1-3mm)								
150-76090	150-76090	T30REC4A	30 lbs	(135)	5.9" (150)	1.3" (33)	500	
150-76093	150-76093 *	T50SOSEC4A	50 lbs	(225)	5.9" (150)	1.2" (31)	500	
150-76091	150-76091	T50REC4A	50 lbs	(225)	8" (202)	1.8" (45)	500	
150-76099	150-76099 *	T50ROSEC4A	50 lbs	(225)	7.9" (200)	1.8" (45)	500	
150-76080	150-76080	T30REC4B	50 lbs	(135)	5.9" (150)	1.3" (33)	500	
156-00109	156-00109 *	T50SOSEC4B	50 lbs	(225)	6.5" (165)	1.2" (31)	500	
150-76079	150-76079 *	T50ROSEC4B	50 lbs	(225)	7.9" (200)	1.8" (45)	500	
150-40593	150-40593 *	T50SOSEC5A	50 lbs	(225)	5.9" (150)	1.2" (31)	500	
150-40592	150-40592	T50REC5A	50 lbs	(225)	8" (202)	1.8" (45)	500	
150-40591	150-40591	T50ROSEC5A	50 lbs	(225)	7.9" (200)	1.8" (45)	500	
156-01007	156-01007	T50RDHEC5A	50 lbs	(225)	8.3" (210)	1.8" (45)	500	
156-05000	156-05000	T30REC5B	30 lbs	(135)	5.9" (150)	1.3" (33)	500	
150-40583	150-40583 *	T50SOSEC5B	50 lbs	(225)	5.9" (150)	1.2" (31)	500	
150-40582	150-40582	T50REC5B	50 lbs	(225)	8" (202)	1.8" (45)	500	
150-40581	150-40581 *	T50ROSEC5B	50 lbs	(225)	7.9" (200)	1.8" (45)	500	

Installation tools - MK7, MK7HT, MK7P, MK9, MK9HT, MK9P.

Dimensions are approximate and subject to technical changes. Use **Part No.** for ordering and **Type** for specification purposes.

* outside serrated cable tie

Two Piece Edge Clip and Cable Tie Assemblies (continued)

Material Data- Cable Tie	
Material	Polyamide 6.6 heat stabilized (PA66HS)
Color	Black
Operating Temperature	-40 °F to +221 °F (-40 °C to +105 °C) continuous
Flammability	UL94 V2



Material Data - Edge Clip	
Material	Polyamide 6.6 high impact modified, heat stabilized (PA66HIRHS)
Color	Black
Operating Temperature	-40 °F to +230 °F (-40 °C to +110 °C) continuous
Flammability	UL94 HB





Article No.	Part No.	Type	Min. Tensile Strength		Length (L)		Max. Ø Bundle		Pkg. Qty.	Drawing
			lbs.	(N)	in.	(mm)	in.	(mm)		
Panel Thickness, — .039" - .117" (1-3mm)										
155-37104	155-37104	T18REC9	18 lbs	(80)	3.9"	(100)	.75"	(19)	500	
156-00019	156-00019 *	T50SOSEC9SD	50 lbs	(225)	5.9"	(150)	1.2"	(31)	500	
156-05903	156-05903	T50ROSEC9	50 lbs	(225)	7.9"	(200)	1.8"	(45)	500	
155-38304	155-38304	T18R-EC10	18 lbs	(80)	3.9"	(100)	.79"	(20)	500	
156-05904	156-05904 *	T50ROSEC10	50 lbs	(225)	7.9"	(200)	1.8"	(45)	500	
156-00017	156-00017	T50SOSEC21	50 lbs	(225)	5.9"	(150)	1.3"	(33)	500	
156-00010	156-00010	T50ROSEC21	50 lbs	(225)	7.9"	(200)	1.8"	(45)	500	
156-00018	156-00018	T50SOSEC22	50 lbs	(225)	5.9"	(150)	1.3"	(33)	500	
156-00011	156-00011	T50ROSEC22	50 lbs	(225)	7.9"	(200)	1.8"	(45)	500	
156-01601	156-01601	CBTO-50R	50 lbs	(225)	8"	(202)	1.85"	(47)	500	

Installation tools - MK7, MK7HT, MK7P, MK9, MK9HT, MK9P.
 Dimensions are approximate and subject to technical changes. Use **Part No.** for ordering and **Type** for specification purposes.

* outside serrated cable tie

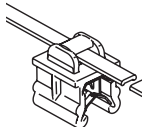
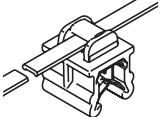
Two Piece Edge Clip and Cable Tie Assemblies (continued)

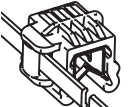
Article No.	Part No.	Type	Min. Tensile Strength		Length (L)		Max. Ø Bundle		Pkg. Qty.	Drawing
			lbs.	(N)	in.	(mm)	in.	(mm)		
Panel Thickness — .117" - .234" (3-6 mm)										
156-04600	156-04600	T18ROSEC19	18 lbs	(80)	3.9"	(100)	.79"	(20)	500	
156-04601	156-04601	T50SOSEC19	50 lbs	(225)	5.9"	(150)	1.2"	(31)	500	
156-04602	156-04602	T50ROSEC19	50 lbs	(225)	7.9"	(200)	1.8"	(45)	500	
156-00016	156-00016	T50SOSEC20	50 lbs	(225)	5.9"	(150)	1.3"	(33)	500	
156-00020	156-00020	T50ROSEC20	50 lbs	(225)	7.9"	(200)	1.8"	(45)	500	
156-00006	156-00006	T50ROSEC23	50 lbs	(225)	7.9"	(200)	1.8"	(45)	500	
156-00007	156-00007	T50ROSEC24	50 lbs	(225)	7.9"	(200)	1.8"	(45)	500	

Installation tools - MK7, MK7HT, MK7P, MK9, MK9HT, MK9P. Dimensions are approximate and subject to technical changes. Use **Part No.** for ordering and **Type** for specification purposes.

One Piece Edge Clip and Cable Tie Combinations

The plastic area of the edge clips and the cable ties are molded together.

Material Data

Material	Polyamide 6.6 heat stabilized (PA66HS)
Color	Black
Operating Temperature	-40 °F to +221 °F (-40 °C to +105 °C) continuous
Flammability	UL94 HB



Product Selection

Article No.	Part No.	Type	Min. Tensile Strength		Length (L)		Max. Ø Bundle		Pkg. Qty.	Drawing
			lbs.	(N)	in.	(mm)	in.	(mm)		
Panel Thickness — .039" - .117" (1-3 mm)										
133-00059	133-00059	T40XEC5SP-E	40 lbs	(178)	4.05"	(103)	.59"	(15)	500	
148-00200	148-00200	T50SOSEC12E	50 lbs	(225)	6.30"	(160)	1.38"	(35)	500	
126-00000	126-00000	T50SOSEC13E	50 lbs	(225)	6.30"	(160)	1.38"	(35)	500	

Installation tools - MK7, MK7HT, MK7P, MK9, MK9HT, MK9P. Dimensions are approximate and subject to technical changes. Use **Part No.** for ordering and **Type** for specification purposes.

Edge Clip and Tape Clip Combination

These clips can be secured to cables with cable ties or tape.

Material Data - Cable Tie and Tape Clip Combination



Material	Polyamide 6.6 high impact modified, heat stabilized (PA66HIRHS)
Color	Black
Operating Temperature	-40 °F to +230 °F (-40 °C to +110 °C) continuous
Flammability	UL94 HB

Product Selection

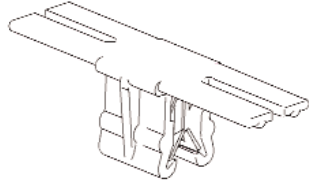
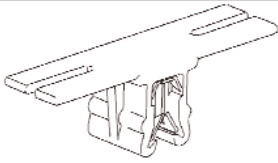
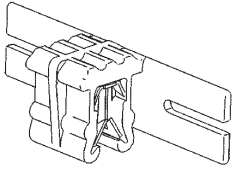
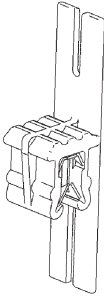
Article No.	Part No.	Type	Length (L)		Width (W)		Pkg. Qty.	Drawing
			in.	(mm)	in.	(mm)		
Panel Thickness — .039" - .117" (1-3 mm)								
151-03404	151-03404	EC14	1.57"	(40.0)	.39"	(10.0)	500	
151-03401	151-03401	EC15	1.57"	(40.0)	.39"	(10.0)	500	
151-03402	151-03402	EC16	1.57"	(40.0)	.39"	(10.0)	500	
151-03403	151-03403	EC17	1.57"	(40.0)	.39"	(10.0)	500	

Dimensions are approximate and subject to technical changes. Use **Part No.** for ordering and **Type** for specification purposes.

Screw Mount Ties

One-piece, all plastic ties for quick, simple cable mounting.

Material Data	
Material	Polyamide 6.6 (PA66)
Operating Temperature	-40 °F to +185 °F (-40 °C to +85 °C) continuous
Flammability	UL94 V2

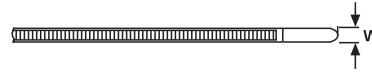
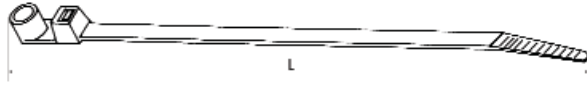

Product Selection												
Article No.	Part No.	Type	Mounting	Min. Tensile Strength lbs. (N)	Length (L) in. (mm)	Max. Ø Bundle in. (mm)	Width (W) in. (mm)	Color	Pkg. Qty.			
T18MR												
113-0026	T18MR9C2	T18MR	# 4 screw	18 lbs (80)	4.33" (110)	.79" (20)	.10" (2.5)	Natural	100			
113-0028	T18MR9M4	T18MR		18 lbs (80)	4.33" (110)	.79" (20)	.10" (2.5)	Natural	1000			
113-0022	T18MR0C2	T18MR		18 lbs (80)	4.33" (110)	.79" (20)	.10" (2.5)	Black	100			
113-0024	T18MR0M4	T18MR		18 lbs (80)	4.33" (110)	.79" (20)	.10" (2.5)	Black	1000			
T30MR												
113-03019	T30MR9C2	T30MR	# 8 screw	30 lbs (135)	6.30" (160)	1.26" (32)	.14" (3.5)	Natural	100			
113-00036	T30MR9M4	T30MR		30 lbs (135)	6.30" (160)	1.26" (32)	.14" (3.5)	Natural	1000			
113-03010	T30MR0C2	T30MR		30 lbs (135)	6.30" (160)	1.26" (32)	.14" (3.5)	Black	100			
113-03011	T30MR0M4	T30MR		30 lbs (135)	6.30" (160)	1.26" (32)	.14" (3.5)	Black	1000			
T50MR												
113-05004	T50MR9C2	T50MR	# 10 screw	48 lbs (215)	8.46" (215)	1.77" (45)	.18" (4.6)	Natural	100			
113-05007	T50MR9M4	T50MR		48 lbs (215)	8.46" (215)	1.77" (45)	.18" (4.6)	Natural	1000			
113-05000	T50MR0C2	T50MR		48 lbs (215)	8.46" (215)	1.77" (45)	.18" (4.6)	Black	100			
113-05002	T50MR0M4	T50MR		48 lbs (215)	8.46" (215)	1.77" (45)	.18" (4.6)	Black	1000			
T50MRT												
113-05101	T50MRT9C2	T50MRT	#6-32 tap thru screw	50 lbs (225)	8.47" (215)	1.77" (45)	.19" (4.7)	Natural	100			
113-05102	T50MRT9M4	T50MRT		50 lbs (225)	8.47" (215)	1.77" (45)	.19" (4.7)	Natural	1000			
113-05100	T50MRT0C2	T50MRT		50 lbs (225)	8.47" (215)	1.77" (45)	.19" (4.7)	Black	100			
113-00037	T50MRT0M4	T50MRT		50 lbs (225)	8.47" (215)	1.77" (45)	.19" (4.7)	Black	1000			
T50MI												
113-00032	T50MI9C2	T50MI	# 10 screw	50 lbs (225)	12.40" (315)	3.35" (85)	.19" (4.7)	Natural	100			
113-00033	T50MI9M4	T50MI		50 lbs (225)	12.40" (315)	3.35" (85)	.19" (4.7)	Natural	1000			
113-00038	T50MI0C2	T50MI		50 lbs (225)	12.40" (315)	3.35" (85)	.19" (4.7)	Black	100			
113-00031	T50MI0M4	T50MI		50 lbs (225)	12.40" (315)	3.35" (85)	.19" (4.7)	Black	1000			
T50ML												
113-05419	T50ML9C2	T50ML	# 10 screw	50 lbs (225)	15.35" (390)	4.00" (100)	.18" (4.6)	Natural	100			
113-05403	T50ML9M4	T50ML		50 lbs (225)	15.35" (390)	4.00" (100)	.18" (4.6)	Natural	1000			
113-00007	T50ML0C2	T50ML		50 lbs (225)	15.35" (390)	4.00" (100)	.18" (4.6)	Black	100			
113-00035	T50ML0M4	T50ML		50 lbs (225)	15.35" (390)	4.00" (100)	.18" (4.6)	Black	1000			
T120MR												
113-12029	T120MR9K2	T120MR	#1/4" screw	120 lbs (535)	15.55" (395)	4.02" (102)	.30" (7.6)	Natural	50			
113-00018	T120MR9H4	T120MR		120 lbs (535)	15.55" (395)	4.02" (102)	.30" (7.6)	Natural	500			
113-12020	T120MR0K2	T120MR		120 lbs (535)	15.55" (395)	4.02" (102)	.30" (7.6)	Black	50			
113-00011	T120MR0H4	T120MR		120 lbs (535)	15.55" (395)	4.02" (102)	.30" (7.6)	Black	500			

Installation tools - MK7, MK7HT, MK7P, MK9, MK9HT, MK9P. Dimensions are approximate and subject to technical changes. Use **Part No.** for ordering and **Type** for specification purposes.

Clamp Ties

The clamp tie has triangular shaped tabs extending beneath the head, allowing for optimal surface contact and complete circumferential compression to 360 degrees. The clamps are recommended for soft rubber hose applications including fuel, water, and air vacuum lines.



Material Data		RoHS
Color	Natural	
Material	Polyamide 6.6 (PA66)	
Operating Temperature	-40 °F to +185 °F (-40 °C to +85 °C) continuous	
Flammability	UL94 V2	

Material Data		RoHS
Color	Black	
Material	Polyamide 6.6 heat stabilized (PA66HS)	
Operating Temperature	-40 °F to +221 °F (-40 °C to +105 °C) continuous	
Flammability	UL94 V2	

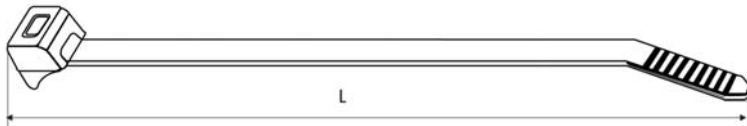

US
File# E64139

Product Selection			Min. Tensile Strength	Length (L)	Max. Ø Bundle	Width (W)	Color	Pkg. Qty.
Article No.	Part No.	Type						
CTT20R								
112-51919	CTT20R9C2	CTT20R	20 lbs (90)	4" (100)	.50" (13)	.10" (2.5)	Natural	100
112-51904	CTT20R9M4	CTT20R	20 lbs (90)	4" (100)	.50" (13)	.10" (2.5)		1000
112-51905	CTT20R0HSC2	CTT20R	20 lbs (90)	4" (100)	.50" (13)	.10" (2.5)	Black	100
112-51960	CTT20R0HSM4	CTT20R	20 lbs (90)	4" (100)	.50" (13)	.10" (2.5)		1000
CTT60R								
112-52104	CTT60R9C2	CTT60R	60 lbs (265)	8" (205)	1.77" (45)	.19" (4.7)	Natural	100
112-52106	CTT60R9M4	CTT60R	60 lbs (265)	8" (205)	1.77" (45)	.19" (4.7)		1000
112-52112	CTT60R0HSC2	CTT60R	60 lbs (265)	8" (205)	1.77" (45)	.19" (4.7)	Black	100
112-52114	CTT60R0HSM4	CTT60R	60 lbs (265)	8" (205)	1.77" (45)	.19" (4.7)		1000

Installation tools - MK7, MK7HT, MK7P, MK9, MK9HT, MK9P. Dimensions are approximate and subject to technical changes. Use **Part No.** for ordering and **Type** for specification purposes.

Branch Tie

The Branch Tie is ideal for wire harness applications where wires “branch” away from the main assembly. The Branch tie reduces wire harness assembly time by eliminating the need to use electrical tape. After the tie is placed on the main assembly, the strap is inserted through the oval opening and then through the cable tie head. Once applied, the Branch Tie holds the branch in its proper position on the wire harness.

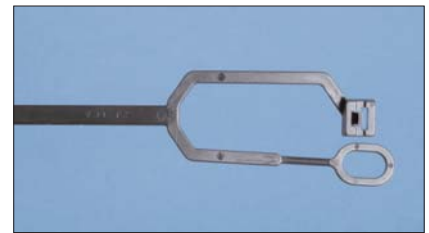

Material Data	
Material	Polyamide 6.6 (PA66)
Operating Temperature	-40 °F to +185 °F (-40 °C to +85 °C) continuous
Flammability	UL94 V2

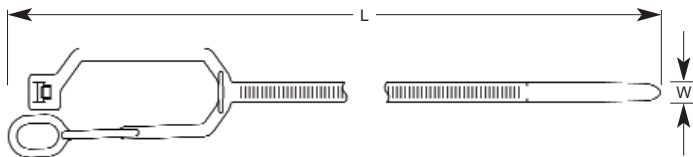

Product Selection		Type	Main Bundle Ø		Branch Bundle Ø		Min. Tensile Strength		Length (L)		Width (W)		Color	Pkg. Qty.
Article No.	Part No.		in.	(mm)	in.	(mm)	lbs.	(N)	in.	(mm)	in.	(mm)		
115-00042	115-00042	YT200	.63" – 1.57"	(16 - 40)	.59" – 1.18"	(15 - 30)	33 lbs	(147)	7.87"	(200)	.18"	(4.7)	Black	100

Installation tools - MK9, MK9HT, MK9P. Dimensions are approximate and subject to technical changes. Use **Part No.** for ordering and **Type** for specification purposes.

Kabelrap Bundling System

The patented Kabelrap bundling system offers a very high bundling strength and is particularly resistant to saltwater, oils, greases, and hydraulic fluids. Special hand tool required for installation.



Required Tool - 121-00680



Kabelrap Application

Material Data	
Material	Polyamide 6.6 UV-resistant (PA66UV)
Operating Temperature	-40 °F to +185 °F (-40 °C to +85 °C) continuous
Flammability	UL94 V2

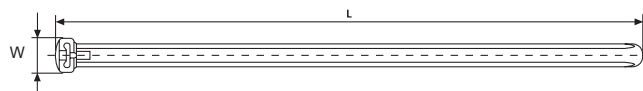

Product Selection		Type	Min. Tensile Strength		Length (L)		Max. Ø Bundle		Width (W)		Color	Pkg. Qty.
Article No.	Part No.		lbs.	(N)	in.	(mm)	in.	(mm)	in.	(mm)		
121-61860	121-61860	KR6/18	110 lbs	(490)	7.25"	(183)	1.5"	(39)	.24"	(6)	Black	50
121-63560	121-63560	KR6/35	110 lbs	(490)	14"	(356)	3.75"	(93)	.25"	(6)	Black	50
121-82160	121-82160	KR8/21	175 lbs	(785)	8.25"	(210)	1.75"	(47)	.31"	(8)	Black	50
121-83360	121-83360	KR8/33	175 lbs	(785)	13.25"	(337)	3.37"	(86)	.31"	(8)	Black	50

Required Installation Tool - 121-00680. Black is the standard color. Natural is available based upon minimums, custom terms and lead times. Dimensions are approximate and subject to technical changes. Use **Part No.** for ordering and **Type** for specification purposes.

Standard Cable Ties

T18 - T30 Series - Natural and Black

Material Data	
Material	Polyamide 6.6 (PA66)
Operating Temperature	-40 °F to +185 °F (-40 °C to +85 °C) continuous
Flammability	UL94 V2

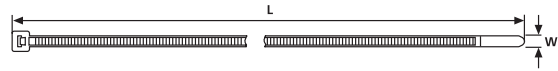

File# E64139

File# E64139

Article No.	Part No.	Type	US Gov. Designation	Min. Tensile Strength		Length (L)		Max. Ø Bundle		Width (W)		Color	Pkg. Qty.
				lbs.	(N)	in.	(mm)	in.	(mm)	in.	(mm)		
T18S													
111-02805	T18S9C2	T18S	MS3367-4-9	18 lbs	(80)	3.27"	(83)	.63"	(16)	.09"	(2.3)	Natural	100
111-02809	T18S9M4	T18S	MS3367-4-9	18 lbs	(80)	3.27"	(83)	.63"	(16)	.09"	(2.3)		1000
111-02810	T18S0C2	T18S	*	18 lbs	(80)	3.27"	(83)	.63"	(16)	.09"	(2.3)	Black	100
111-02811	T18S0M4	T18S	*	18 lbs	(80)	3.27"	(83)	.63"	(16)	.09"	(2.3)		1000
T18R													
112-01819	T18R9C2	T18R	MS3367-4-9	18 lbs	(80)	4"	(100)	.87"	(22)	.10"	(2.5)	Natural	100
111-01872	T18R9M4	T18R	MS3367-4-9	18 lbs	(80)	4"	(100)	.87"	(22)	.10"	(2.5)		1000
111-00405	T18R0C2	T18R	*	18 lbs	(80)	4"	(100)	.87"	(22)	.10"	(2.5)	Black	100
111-01841	T18R0M4	T18R	*	18 lbs	(80)	4"	(100)	.87"	(22)	.10"	(2.5)		1000
T18I													
111-02311	T18I9C2	T18I	-	18 lbs	(80)	5.51"	(140)	1.38"	(35)	.10"	(2.5)	Natural	100
111-02322	T18I9M4	T18I	-	18 lbs	(80)	5.51"	(140)	1.38"	(35)	.10"	(2.5)		1000
111-02308	T18I0C2	T18I	-	18 lbs	(80)	5.51"	(140)	1.38"	(35)	.10"	(2.5)	Black	100
111-02315	T18I0M4	T18I	-	18 lbs	(80)	5.51"	(140)	1.38"	(35)	.10"	(2.5)		1000
T18L													
111-02189	T18L9C2	T18L	-	18 lbs	(80)	8.0"	(205)	2.17"	(55)	.10"	(2.5)	Natural	100
111-02026	T18L9M4	T18L	-	18 lbs	(80)	8.0"	(205)	2.17"	(55)	.10"	(2.5)		1000
111-00401	T18L0C2	T18L	-	18 lbs	(80)	8.0"	(205)	2.17"	(55)	.10"	(2.5)	Black	100
111-02015	T18L0M4	T18L	-	18 lbs	(80)	8.0"	(205)	2.17"	(55)	.10"	(2.5)		1000
T30R													
112-03019	T30R9C2	T30R	MS3367-5-9	30 lbs	(135)	5.9"	(150)	1.38"	(35)	.14"	(3.5)	Natural	100
111-03047	T30R9M4	T30R	MS3367-5-9	30 lbs	(135)	5.9"	(150)	1.38"	(35)	.14"	(3.5)		1000
111-00438	T30R0C2	T30R	*	30 lbs	(135)	5.9"	(150)	1.38"	(35)	.14"	(3.5)	Black	100
111-03034	T30R0M4	T30R	*	30 lbs	(135)	5.9"	(150)	1.38"	(35)	.14"	(3.5)		1000
T30L													
111-03325	T30L9C2	T30L	-	30 lbs	(135)	7.48"	(190)	1.97"	(50)	.14"	(3.5)	Natural	100
111-03327	T30L9M4	T30L	-	30 lbs	(135)	7.48"	(190)	1.97"	(50)	.14"	(3.5)		1000
111-03313	T30L0C2	T30L	-	30 lbs	(135)	7.48"	(190)	1.97"	(50)	.14"	(3.5)	Black	100
111-03315	T30L0M4	T30L	-	30 lbs	(135)	7.48"	(190)	1.97"	(50)	.14"	(3.5)		1000
T30LL													
111-03515	T30LL9C2	T30LL	-	30 lbs	(135)	11.42"	(290)	3.15"	(80)	.14"	(3.5)	Natural	100
111-03517	T30LL9M4	T30LL	-	30 lbs	(135)	11.42"	(290)	3.15"	(80)	.14"	(3.5)		1000
111-03501	T30LL0C2	T30LL	-	30 lbs	(135)	11.42"	(290)	3.15"	(80)	.14"	(3.5)	Black	100
111-03511	T30LL0M4	T30LL	-	30 lbs	(135)	11.42"	(290)	3.15"	(80)	.14"	(3.5)		1000
T30XL													
111-02900	T30XL9C2	T30XL	MS3367-5-9	30 lbs	(135)	14.37"	(365)	4.13"	(105)	.14"	(3.5)	Natural	100
111-02907	T30XL9M4	T30XL	MS3367-5-9	30 lbs	(135)	14.37"	(365)	4.13"	(105)	.14"	(3.5)		1000
111-02901	T30XL0C2	T30XL	*	30 lbs	(135)	14.37"	(365)	4.13"	(105)	.14"	(3.5)	Black	100
111-02903	T30XL0M4	T30XL	*	30 lbs	(135)	14.37"	(365)	4.13"	(105)	.14"	(3.5)		1000

Installation tools - MK7, MK7HT, MK7P, MK9, MK9HT, MK9P. MK9 and MK9P cannot be used with T18S cable ties.

Dimensions are approximate and subject to technical changes. Use **Part No.** for ordering and **Type** for specification purposes.

* Military black available. Contact HellaermannTyton for more information.

Standard Cable Ties

T40 - T50 Series - Natural and Black

Material Data	
Material	Polyamide 6.6 (PA66)
Operating Temperature	-40 °F to +185 °F (-40 °C to +85 °C) continuous
Flammability	UL94 V2

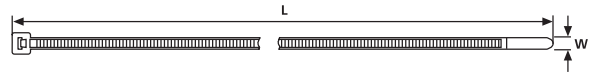

File# E64139



File# E64139

Product Selection

Article No.	Part No.	Type	US Gov. Designation	Min. Tensile Strength		Length (L)		Max. Ø Bundle		Width (W)		Color	Pkg. Qty.
				lbs.	(N)	in.	(mm)	in.	(mm)	in.	(mm)		
T40R													
112-04019	T40R9C2	T40R(U)	–	40 lbs	(180)	8.27"	(210)	2.16"	(55)	.16"	(4.0)	Natural	100
111-04131	T40R9M4	T40R(U)	–	40 lbs	(180)	8.27"	(210)	2.16"	(55)	.16"	(4.0)		1000
112-04060	T40R0C2	T40R(U)	–	40 lbs	(180)	8.27"	(210)	2.16"	(55)	.16"	(4.0)	Black	100
111-04122	T40R0M4	T40R(U)	–	40 lbs	(180)	8.27"	(210)	2.16"	(55)	.16"	(4.0)		1000
T40I													
111-04609	T40I9C2	T40I	–	40 lbs	(180)	11.42"	(290)	3.15"	(80)	.16"	(4.0)	Natural	100
111-04612	T40I9M4	T40I	–	40 lbs	(180)	11.42"	(290)	3.15"	(80)	.16"	(4.0)		1000
111-04600	T40I0C2	T40I	–	40 lbs	(180)	11.42"	(290)	3.15"	(80)	.16"	(4.0)	Black	100
111-04604	T40I0M4	T40I	–	40 lbs	(180)	11.42"	(290)	3.15"	(80)	.16"	(4.0)		1000
T40L													
111-04300	T40L9C2	T40L	–	40 lbs	(180)	14.4"	(365)	4.13"	(105)	.16"	(4.0)	Natural	100
111-04311	T40L9M4	T40L	–	40 lbs	(180)	14.4"	(365)	4.13"	(105)	.16"	(4.0)		1000
111-04301	T40L0C2	T40L	–	40 lbs	(180)	14.4"	(365)	4.13"	(105)	.16"	(4.0)	Black	100
111-04305	T40L0M4	T40L	–	40 lbs	(180)	14.4"	(365)	4.13"	(105)	.16"	(4.0)		1000
T50S													
111-05811	T50S9C2	T50S	–	50 lbs	(225)	5.9"	(150)	1.38"	(35)	.18"	(4.6)	Natural	100
111-05813	T50S9M4	T50S	–	50 lbs	(225)	5.9"	(150)	1.38"	(35)	.18"	(4.6)		1000
111-05806	T50S0C2	T50S	–	50 lbs	(225)	5.9"	(150)	1.38"	(35)	.18"	(4.6)	Black	100
111-05808	T50S0M4	T50S	–	50 lbs	(225)	5.9"	(150)	1.38"	(35)	.18"	(4.6)		1000
T50R													
112-05019	T50R9C2	T50R	MS3367-1-9	50 lbs	(225)	7.9"	(200)	1.97"	(50)	.18"	(4.6)	Natural	100
111-04862	T50R9M4	T50R	MS3367-1-9	50 lbs	(225)	7.9"	(200)	1.97"	(50)	.18"	(4.6)		1000
111-04878	T50R0C2	T50R	*	50 lbs	(225)	7.9"	(200)	1.97"	(50)	.18"	(4.6)	Black	100
111-04846	T50R0M4	T50R	*	50 lbs	(225)	7.9"	(200)	1.97"	(50)	.18"	(4.6)		1000
T50I													
112-05219	T50I9C2	T50I	MS3367-7-9	50 lbs	(225)	11.8"	(300)	3.35"	(85)	.18"	(4.6)	Natural	100
111-05230	T50I9M4	T50I	MS3367-7-9	50 lbs	(225)	11.8"	(300)	3.35"	(85)	.18"	(4.6)		1000
111-00444	T50I0C2	T50I	*	50 lbs	(225)	11.8"	(300)	3.35"	(85)	.18"	(4.6)	Black	100
111-05216	T50I0M4	T50I	*	50 lbs	(225)	11.8"	(300)	3.35"	(85)	.18"	(4.6)		1000
T50L													
112-05419	T50L9C2	T50L	MS3367-2-9	50 lbs	(225)	15.35"	(390)	4.33"	(110)	.18"	(4.6)	Natural	100
111-05449	T50L9M4	T50L	MS3367-2-9	50 lbs	(225)	15.35"	(390)	4.33"	(110)	.18"	(4.6)		1000
111-00445	T50L0C2	T50L	*	50 lbs	(225)	15.35"	(390)	4.33"	(110)	.18"	(4.6)	Black	100
111-00504	T50L0M4	T50L	*	50 lbs	(225)	15.35"	(390)	4.33"	(110)	.18"	(4.6)		1000

Installation tools - MK7, MK7HT, MK7P, MK9, MK9HT, MK9P. Dimensions are approximate and subject to technical changes.

Use **Part No.** for ordering and **Type** for specification purposes.

* Military black available. Contact HellermannTyton for more information.

Heavy Duty Cable Ties

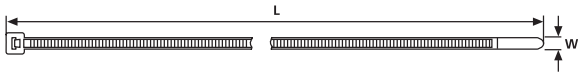

Material Data	
Material	Polyamide 6.6 (PA66)
Operating Temperature	-40 °F to +185 °F (-40 °C to +85 °C) continuous
Flammability	UL94 V2



T120 Series



Product Selection													
Article No.	Part No.	Type	US Gov. Designation	Min. Tensile Strength		Length (L)		Max. Ø Bundle		Width (W)	Color	Pkg. Qty.	
				lbs.	(N)	in.	(mm)	in.	(mm)				in.
T120S													
111-12819	T120S9K2	T120S	-	120 lbs	(535)	8.85"	(225)	2.17"	(55)	.30"	(7.6)	Natural	50
111-12813	T120S9H4	T120S	-	120 lbs	(535)	8.85"	(225)	2.17"	(55)	.30"	(7.6)	Natural	500
111-12803	T120S0K2	T120S	-	120 lbs	(535)	8.85"	(225)	2.17"	(55)	.30"	(7.6)	Black	50
111-12808	T120S0H4	T120S	-	120 lbs	(535)	8.85"	(225)	2.17"	(55)	.30"	(7.6)	Black	500
T120I													
111-12211	T120I9K2	T120I	-	120 lbs	(535)	11.81"	(300)	3.15"	(80)	.30"	(7.6)	Natural	50
111-12213	T120I9H4	T120I	-	120 lbs	(535)	11.81"	(300)	3.15"	(80)	.30"	(7.6)	Natural	500
111-12201	T120I0K2	T120I	-	120 lbs	(535)	11.81"	(300)	3.15"	(80)	.30"	(7.6)	Black	50
111-12206	T120I0H4	T120I	-	120 lbs	(535)	11.81"	(300)	3.15"	(80)	.30"	(7.6)	Black	500
T120R													
112-12019	T120R9K2	T120R	MS3367-3-9	120 lbs	(535)	15.24"	(387)	4.13"	(105)	.30"	(7.6)	Natural	50
111-12036	T120R9H4	T120R	MS3367-3-9	120 lbs	(535)	15.24"	(387)	4.13"	(105)	.30"	(7.6)	Natural	500
112-12060	T120R0K2	T120R	*	120 lbs	(535)	15.24"	(390)	4.13"	(105)	.30"	(7.6)	Black	50
111-12013	T120R0H4	T120R	*	120 lbs	(535)	15.24"	(387)	4.13"	(105)	.30"	(7.6)	Black	500
T120L													
111-12419	T120L9K2	T120L	MS3367-6-9	120 lbs	(535)	30.0"	(760)	8.85"	(225)	.30"	(7.6)	Natural	50
111-12405	T120L0K2	T120L	*	120 lbs	(535)	30.0"	(760)	8.85"	(225)	.30"	(7.6)	Black	50

Installation tools - MK9, MK9HT, MK9P. Dimensions are approximate and subject to technical changes. Use **Part No.** for ordering and **Type** for specification purposes. *Military black available. Contact HellermannTyton for more information.

T150 Series



Product Selection													
Article No.	Part No.	Type	US Gov. Designation	Min. Tensile Strength		Length (L)		Max. Ø Bundle		Width (W)	Color	Pkg. Qty.	
				lbs.	(N)	in.	(mm)	in.	(mm)				in.
T150R													
111-15203	T150R9X2	T150R(U)	-	175 lbs	(780)	15.35"	(390)	4.13"	(105)	.35"	(8.8)	Natural	25
111-15200	T150R0X2	T150R(U)	-	175 lbs	(780)	15.35"	(390)	4.13"	(105)	.35"	(8.8)	Black	25
T150M													
111-15619	T150M9X2	T150M	-	175 lbs	(780)	21.00"	(530)	5.91"	(150)	.35"	(8.9)	Natural	25
111-00124	T150M0X2	T150M	-	175 lbs	(780)	21.00"	(530)	5.91"	(150)	.35"	(8.9)	Black	25
T150L													
111-15419	T150L9X2	T150L	-	175 lbs	(780)	32.28"	(820)	9.65"	(245)	.35"	(8.9)	Natural	25
111-15405	T150L0X2	T150L	-	175 lbs	(780)	32.28"	(820)	9.65"	(245)	.35"	(8.9)	Black	25
T150LL													
111-15719	T150LL9X2	T150LL	-	175 lbs	(780)	36.42"	(925)	10.83"	(275)	.35"	(8.9)	Natural	25
111-15700	T150LL0X2	T150LL	-	175 lbs	(780)	36.42"	(925)	10.83"	(275)	.35"	(8.9)	Black	25
T150XL													
111-15519	T150XL9X2	T150XL	-	175 lbs	(780)	43.11"	(1095)	13.00"	(330)	.35"	(8.9)	Natural	25
111-15500	T150XL0X2	T150XL	-	175 lbs	(780)	43.11"	(1095)	13.00"	(330)	.35"	(8.9)	Black	25
T150XLL													
111-15304	T150XLL9X2	T150XLL	-	175 lbs	(780)	52.17"	(1325)	15.95"	(405)	.35"	(8.9)	Natural	25
111-15300	T150XLL0X2	T150XLL	-	175 lbs	(780)	52.17"	(1325)	15.95"	(405)	.35"	(8.9)	Black	25

Installation tools - MK9, MK9HT, MK9P. Dimensions are approximate and subject to technical changes. Use **Part No.** for ordering and **Type** for specification purposes.

Standard Cable Ties- Specialty Materials T18 - T120 Series - Heat Stabilized

HellermannTyton's heat stabilized cable ties provide excellent resistance when exposed to high heat applications.

Material Data	
Material	Polyamide 6.6 heat stabilized (PA66HS)
Operating Temperature	-40 °F to +221 °F (-40 °C to +105 °C) continuous
Flammability	UL94 V2

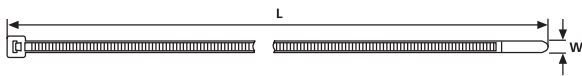

Product Selection		Type	Min. Tensile Strength		Length (L)		Max. Ø Bundle		Width (W)		Color	Pkg. Qty.
Article No.	Part No.		lbs.	(N)	in.	(mm)	in.	(mm)	in.	(mm)		
T18S												
111-02815	T18S0HSM4	T18S	18 lbs	(80)	3.27"	(83)	.63"	(16)	.09"	(2.3)	Black	1000
T18R												
111-01905	T18R0HSC2	T18R	18 lbs	(80)	4"	(100)	.87"	(22)	.10"	(2.5)	Black	100
111-00476	T18R0HSM4	T18R	18 lbs	(80)	4"	(100)	.87"	(22)	.10"	(2.5)	Black	1000
T18I												
111-02305	T18I0HSM4	T18I	18 lbs	(80)	5.5"	(140)	1.38"	(35)	.10"	(2.5)	Black	1000
T18L												
111-00403	T18L0HSC2	T18L	18 lbs	(80)	8.0"	(205)	2.17"	(55)	.10"	(2.5)	Black	100
111-00404	T18L0HSM4	T18L	18 lbs	(80)	8.0"	(205)	2.17"	(55)	.10"	(2.5)	Black	1000
T30R												
111-03067	T30R0HSC2	T30R	30 lbs	(135)	5.9"	(150)	1.38"	(35)	.14"	(3.5)	Black	100
111-03068	T30R0HSM4	T30R	30 lbs	(135)	5.9"	(150)	1.38"	(35)	.14"	(3.5)	Black	1000
T50R												
111-04900	T50R0HSC2	T50R	50 lbs	(225)	7.9"	(200)	1.97"	(50)	.18"	(4.6)	Black	100
111-04901	T50R0HSM4	T50R	50 lbs	(225)	7.9"	(200)	1.97"	(50)	.18"	(4.6)	Black	1000
T50I												
111-05248	T50I0HSC2	T50I	50 lbs	(225)	11.8"	(300)	3.35"	(85)	.18"	(4.6)	Black	100
111-05251	T50I0HSM4	T50I	50 lbs	(225)	11.8"	(300)	3.35"	(85)	.18"	(4.6)	Black	1000
T50L												
111-05470	T50L0HSC2	T50L	50 lbs	(225)	15.35"	(390)	4.33"	(110)	.18"	(4.6)	Black	100
111-05471	T50L0HSM4	T50L	50 lbs	(225)	15.35"	(390)	4.33"	(110)	.18"	(4.6)	Black	1000
T120R												
111-12061	T120R0HSC2	T120R	120 lbs	(535)	15.24"	(387)	4.13"	(105)	.30"	(7.6)	Black	50
111-12058	T120R0HSH4	T120R	120 lbs	(535)	15.24"	(387)	4.13"	(105)	.30"	(7.6)	Black	500

Installation tools - MK7, MK7HT, MK7P, MK9, MK9HT, MK9P. MK9, MK9HT, and MK9P tools cannot be used with T18S cable ties. Dimensions are approximate and subject to technical changes. Use **Part No.** for ordering and **Type** for specification purposes.

Standard Cable Ties- Specialty Materials T18 -T50 Series - Flame Retardant

HellermannTyton's flame retardant cable ties meet the UL 94V0 flammability requirements.

Material Data	
Material	Polyamide 6.6 V0 (PA66V0)
Operating Temperature	-40 °F to +185 °F (-40 °C to +85 °C) continuous
Flammability	UL94 V0

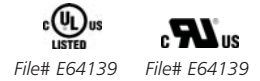
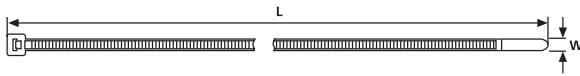

Product Selection		Type	Min. Tensile Strength		Length (L)		Max. Ø Bundle		Width (W)		Color	Pkg. Qty.
Article No.	Part No.		lbs.	(N)	in.	(mm)	in.	(mm)	in.	(mm)		
T18R												
111-01834	T18R9VOC2	T18R	18 lbs	(80)	4"	(100)	.87"	(22)	.10"	(2.5)	White	100
111-01835	T18R9VOM4	T18R	18 lbs	(80)	4"	(100)	.87"	(22)	.10"	(2.5)	White	1000
111-01833	T18R0VOC2	T18R	18 lbs	(80)	4"	(100)	.87"	(22)	.10"	(2.5)	Black	100
T18I												
111-02304	T18I9VOM4	T18I	18 lbs	(80)	5.5"	(144)	1.38"	(35)	.10"	(2.5)	White	1000
T18L												
111-02045	T18L9VOC2	T18L	18 lbs	(80)	7.95"	(202)	2.17"	(55)	.10"	(2.5)	White	100
111-02046	T18L9VOM4	T18L	18 lbs	(80)	7.95"	(202)	2.17"	(55)	.10"	(2.5)	White	1000
111-02044	T18L0VOC2	T18L	18 lbs	(80)	7.95"	(202)	2.17"	(55)	.10"	(2.5)	Black	100
T30R												
111-03073	T30R9VOC2	T30R	30 lbs	(135)	5.83"	(148)	1.38"	(35)	.14"	(3.6)	White	100
111-03074	T30R9VOM4	T30R	30 lbs	(135)	5.83"	(148)	1.38"	(35)	.14"	(3.6)	White	1000
111-03072	T30R0VOC2	T30R	30 lbs	(135)	5.83"	(148)	1.38"	(35)	.14"	(3.6)	Black	100
T50R												
111-04909	T50R9VOC2	T50R	50 lbs	(225)	7.95"	(202)	1.97"	(50)	.18"	(4.6)	White	100
111-04911	T50R9VOM4	T50R	50 lbs	(225)	7.95"	(202)	1.97"	(50)	.18"	(4.6)	White	1000
111-04887	T50R0VOC2	T50R	50 lbs	(225)	7.95"	(202)	1.97"	(50)	.18"	(4.6)	Black	100
111-04908	T50R0VOM4	T50R	50 lbs	(225)	7.95"	(202)	1.97"	(50)	.18"	(4.6)	Black	1000
T50I												
111-05254	T50I9VOC2	T50I	50 lbs	(225)	11.82"	(300)	3.35"	(85)	.18"	(4.6)	White	100
111-05255	T50I9VOM4	T50I	50 lbs	(225)	11.82"	(300)	3.35"	(85)	.18"	(4.6)	White	1000
111-05258	T50I0VOC2	T50I	50 lbs	(225)	11.82"	(300)	3.35"	(85)	.18"	(4.6)	Black	100
T50L												
111-05438	T50L9VOC2	T50L	50 lbs	(225)	15.35"	(390)	4.33"	(110)	.19"	(4.7)	White	100
111-05476	T50L9VOM4	T50L	50 lbs	(225)	15.35"	(390)	4.33"	(110)	.19"	(4.7)	White	1000
111-05475	T50L0VOC2	T50L	50 lbs	(225)	15.35"	(390)	4.33"	(110)	.19"	(4.7)	Black	100

Installation tools - MK7, MK7HT, MK7P, MK9, MK9HT, MK9P. Dimensions are approximate and subject to technical changes. Use **Part No.** for ordering and **Type** for specification purposes.

Standard Cable Ties- Specialty Materials T18 - T120 Series - Polypropylene

HellermannTyton's polypropylene cable ties offer added resistance to most chemicals.

Material Data	
Material	Polypropylene (PP)
Operating Temperature	-40 °F to +239 °F (-40 °C to +115 °C) continuous
Flammability	UL94 HB

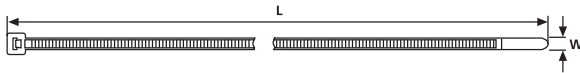

Product Selection			Min. Tensile Strength	Length (L)	Max. Ø Bundle	Width (W)	Color	Pkg. Qty.
Article No.	Part No.	Type						
T18R								
111-01921	T18R9PPC2	T18R	11 lbs (49)	4" (100)	.75" (19)	.10" (2.5)	Natural	100
111-01922	T18R9PPM4	T18R	11 lbs (49)	4" (100)	.75" (19)	.10" (2.5)	Natural	1000
111-01917	T18R0PPC2	T18R	11 lbs (49)	4" (100)	.75" (19)	.10" (2.5)	Black	100
111-01918	T18R0PPM4	T18R	11 lbs (49)	4" (100)	.75" (19)	.10" (2.5)	Black	1000
T30R								
111-03017	T30R9PPC2	T30R	20 lbs (89)	5.83" (148)	1.26" (32)	.14" (3.6)	Natural	100
T50R								
111-04931	T50R9PPC2	T50R	30 lbs (133)	8.0" (203.8)	1.75" (44.5)	.19" (4.7)	Natural	100
111-04928	T50R0PPC2	T50R	30 lbs (133)	8.0" (203.8)	1.75" (44.5)	.19" (4.7)	Black	100
111-04929	T50R0PPM4	T50R	30 lbs (133)	8.0" (203.8)	1.75" (44.5)	.19" (4.7)	Black	1000
T50I								
111-05262	T50I9PPM4	T50I	30 lbs (133)	11.8" (300)	3.35" (85)	.18" (4.6)	Natural	1000
T50L								
111-05483	T50L9PPM4	T50L	30 lbs (133)	15.35" (390)	4.33" (110)	.18" (4.7)	Natural	1000
111-05482	T50L0PPC2	T50L	30 lbs (133)	15.35" (390)	4.33" (110)	.18" (4.7)	Black	100
T120R								
111-12067	T120R0PPK2	T120R	60 lbs (267)	15.35" (390)	4.13" (105)	.30" (7.6)	Black	50
111-12066	T120R0PPH4	T120R	60 lbs (267)	15.35" (390)	4.13" (105)	.30" (7.6)	Black	500

Installation tools - MK7, MK7HT, MK7P, MK9, MK9HT, MK9P. Dimensions are approximate and subject to technical changes. Use **Part No.** for ordering and **Type** for specification purposes.

PEEK Ties For High Temperature Applications

HellermannTyton's high performance PEEK cable ties withstand temperatures up to +500°F (+260°C). PEEK ties are also highly resistant to chemicals and abrasion. PEEK ties offer a tensile strength of 52 lbs. with the minimal insertion force of 1 lb. The contoured head makes the tie ideal for space restricted areas and the outside serrations minimize any damage to the cable insulation.



The contoured head takes up less space, gives a low insertion force, and offers high strength.

Material Data	
Material	Polyetheretherketone (PEEK)
Operating Temperature	-67 °F to +500 °F (-55 °C to +260 °C)
Flammability	UL94 V0

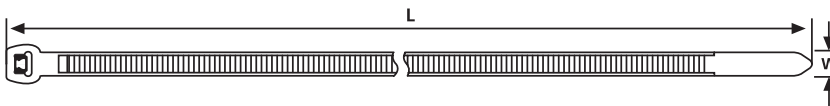

The head design of PEEK Ties

Product Selection			Length (L)	Width (W)	Min. Ø Bundle	Max. Ø Bundle	Min. Tensile Strength	Color	Pkg. Qty.
Article No.	Part No.	Type							
118-00032	118-00032	PT2A	5.7 (145)	.13 (3.4)	.06 (1.6)	1.38 (35)	52 lbs (230)	Brown	100

Installation tools - MK7, MK7P. Use **Part No.** for ordering and **Type** for specification purposes.

Tefzel® Cable Ties

Tefzel ties provide excellent protection against radiation, ultraviolet light, and a wide range of chemicals. They are also rated for low outgassing applications. HellermannTyton's Tefzel ties come in a standard color of blue for easy identification.

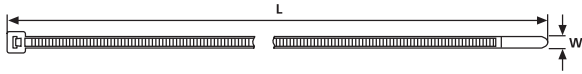

Material Data		RoHS	
Material	Ethylentetrafluorethylen - Tefzel (E/TFE)		
Operating Temperature	-112 °F to +302 °F (-80 °C to +150 °C) continuous		
Flammability	UL94 V0		

Product Selection

Article No.	Part No.	Type	Min. Tensile Strength		Length (L)		Max. Ø Bundle		Width (W)		Color	Pkg. Qty.
			lbs.	(N)	in.	(mm)	in.	(mm)	in.	(mm)		
111-01923	T18R6TZC2	T18R(U)	9.0 lbs	(40)	4"	(100)	.87"	(22)	.10"	(2.5)	Blue	100
111-01924	T18R6TZM4	T18R(U)	9.0 lbs	(40)	4"	(100)	.87"	(22)	.10"	(2.5)	Blue	1000
111-05026	T50R6TZC2	T50R(U)	35.5 lbs	(158)	8"	(200)	1.75"	(50)	.18"	(4.6)	Blue	100
111-04933	T50R6TZM4	T50R(U)	35.5 lbs	(158)	8"	(200)	1.75"	(50)	.18"	(4.6)	Blue	1000
111-12026	T120R6TZK2	T120R	70 lbs	(311)	15"	(380)	4.0"	(100)	.30"	(7.6)	Blue	50

Tefzel is a registered trademark of E.I. DuPont Corporation. Installation tools - MK7, MK7HT, MK7P, MK9, MK9HT, MK9P.

Dimensions are approximate and subject to technical changes. Use **Part No.** for ordering and **Type** for specification purposes.

Outside Serrated Cable Ties

The outside serrated cable ties are for specific applications where thin walled or soft insulation is used (such as in aircraft, trains, etc.) and for applications that are very sensitive to the amount of force applied to the cable.



Outside serrated cable ties are also available in natural. Contact HellermannTyton for more information.

Material Data		RoHS	
Material	Polyamide 6.6 heat stabilized (PA66HS)		
Operating Temperature	-40 °F to +221 °F (-40 °C to +105 °C) continuous		
Flammability	UL94 V2		

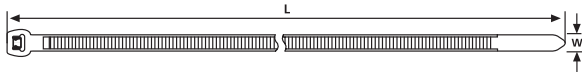

Product Selection

Article No.	Part No.	Type	Min. Tensile Strength		Length (L)		Max. Ø Bundle		Width (W)		Color	Pkg. Qty.
			lbs.	(N)	in.	(mm)	in.	(mm)	in.	(mm)		
118-04700	118-04700	T18ROS	18 lbs	(80)	3.94"	(100)	.79"	(20)	.10"	(2.5)	Black	100
118-04800	118-04800	T30ROS	30 lbs	(135)	5.71"	(145)	1.34"	(35)	.13"	(3.4)	Black	100
118-04900	118-04900	T30LOS	30 lbs	(135)	7.87"	(200)	2.0"	(50)	.13"	(3.4)	Black	100
118-05850	118-05850	T50SOS	50 lbs	(225)	5.9"	(150)	1.38"	(35)	.18"	(4.6)	Black	100
118-05050	118-05050	T50ROS	50 lbs	(225)	8"	(200)	1.95"	(50)	.18"	(4.6)	Black	100
118-05900	118-05900	T50LOS	50 lbs	(225)	15"	(384)	4.29"	(110)	.18"	(4.6)	Black	100

Installation tools - MK7, MK7HT, MK7P, MK9, MK9HT, MK9P. Dimensions are approximate and subject to technical changes. Use **Part No.** for ordering and **Type** for specification purposes.

Releasable Ties

The extended pawl allows for simple and quick release of the ties. Perfect for prototype construction and service requiring the addition of wires on existing harnesses.

Material Data	
Material	Polyamide 6.6 (PA66)
Operating Temperature	-40 °F to +185 °F (-40 °C to +85 °C) continuous
Flammability	UL94 V2

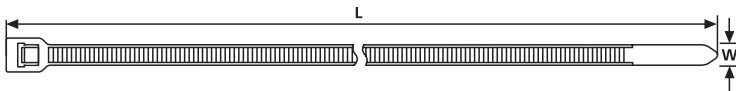

RT40R



RT50S and RT50LL

US
File# E64139

Product Selection			Min. Tensile Strength	Length (L)	Max. Ø Bundle	Width (W)	Color	Pkg. Qty.
Article No.	Part No.	Type						
RT40R								
115-06219	RT40R9C2	RT40R	34 lbs (150)	8.46" (215)	2.0" (51)	.16" (4.0)	Natural	100
115-06204	RT40R9M4	RT40R	34 lbs (150)	8.46" (215)	2.0" (51)	.16" (4.0)		1000
115-06200	RT40R0C2	RT40R	34 lbs (150)	8.46" (215)	2.0" (51)	.16" (4.0)	Black	100
115-06202	RT40R0M4	RT40R	34 lbs (150)	8.46" (215)	2.0" (51)	.16" (4.0)		1000
RT50S								
115-06319	RT50S9C2	RT50S	50 lbs (225)	6.5" (165)	1.38" (35)	.18" (4.6)	Natural	100
115-06304	RT50S9M4	RT50S	50 lbs (225)	6.5" (165)	1.38" (35)	.18" (4.6)		1000
115-06300	RT50S0C2	RT50S	50 lbs (225)	6.5" (165)	1.38" (35)	.18" (4.6)	Black	100
115-00035	RT50S0M4	RT50S	50 lbs (225)	6.5" (165)	1.38" (35)	.18" (4.6)		1000
RT50LL								
115-06102	RT50LL9C2	RT50LL	50 lbs (225)	15" (380)	3.98" (101)	.18" (4.6)	Natural	100
115-06104	RT50LL9M4	RT50LL	50 lbs (225)	15" (380)	3.98" (101)	.18" (4.6)		1000
115-00039	RT50LL0C2	RT50LL	50 lbs (225)	15" (380)	3.98" (101)	.18" (4.6)	Black	100
115-06101	RT50LL0M4	RT50LL	50 lbs (225)	15" (380)	3.98" (101)	.18" (4.6)		1000

Dimensions are approximate and subject to technical changes. Use **Part No.** for ordering and **Type** for specification purposes.

REL Releasable Ties

Ideal for use in applications where there is the need to repeatedly open and close the tie.



Material Data	
Material	Polyamide 6.6 (PA66)
Operating Temperature	-40 °F to +185 °F (-40 °C to +85 °C) continuous
Flammability	UL94 V2

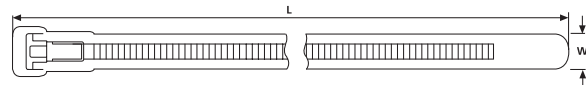

Product Selection

Article No.	Part No.	Type	Min. Tensile Strength		Length (L)		Max. Ø Bundle		Width (W)		Color	Pkg. Qty.
			lbs.	(N)	in.	(mm)	in.	(mm)	in.	(mm)		
REL50R												
115-00503	REL50R9C2	REL50R	50 lbs	(225)	5.5"	(140)	1.38"	(35)	.29"	(7.4)	Natural	100
115-00505	REL50R9L4	REL50R	50 lbs	(225)	5.5"	(140)	1.38"	(35)	.29"	(7.4)		200
115-00500	REL50R0C2	REL50R	50 lbs	(225)	5.5"	(140)	1.38"	(35)	.29"	(7.4)	Black	100
115-00502	REL50R0L4	REL50R	50 lbs	(225)	5.5"	(140)	1.38"	(35)	.29"	(7.4)		200
REL50L												
115-00605	REL50L9C2	REL50L	50 lbs	(225)	9.84"	(250)	2.76"	(70)	.29"	(7.4)	Natural	100
115-00607	REL50L9L4	REL50L	50 lbs	(225)	9.84"	(250)	2.76"	(70)	.29"	(7.4)		200
115-00600	REL50L0C2	REL50L	50 lbs	(225)	9.84"	(250)	2.76"	(70)	.29"	(7.4)	Black	100
115-00602	REL50L0L4	REL50L	50 lbs	(225)	9.84"	(250)	2.76"	(70)	.29"	(7.4)		200

Dimensions are approximate and subject to technical changes. Use **Part No.** for ordering and **Type** for specification purposes.

Pinch Releasable Ties

Patented pinch release mechanism for easy handling allows tie to be released using one hand.

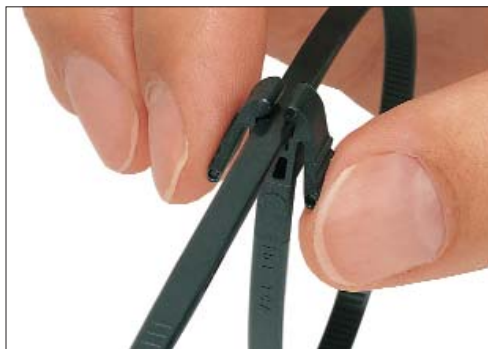

Material Data	
Material	Polyamide 6.6 (PA66)
Operating Temperature	-40 °F to +185 °F (-40 °C to +85 °C) continuous
Flammability	UL94 V2

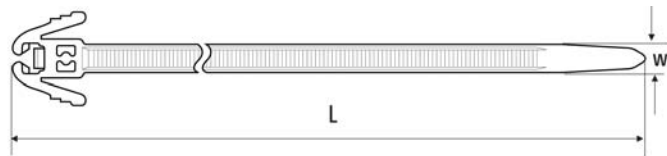

Product Selection

Article No.	Part No.	Type	Min. Tensile Strength		Length (L)		Max. Ø Bundle		Width (W)		Color	Pkg. Qty.
			lbs.	(N)	in.	(mm)	in.	(mm)	in.	(mm)		
115-40200	REZ200.NB3P	REZ200	30 lbs	(135)	7.88"	(200)	1.97"	(50)	.19"	(4.7)	Black	100
115-40300	REZ300.NB3P	REZ300	30 lbs	(135)	12.00"	(305)	3.15"	(80)	.19"	(4.7)	Black	100

Dimensions are approximate and subject to technical changes. Use **Part No.** for ordering and **Type** for specification purposes.

Heavy Duty Releasable Cable Ties

The RT150 and RT250 heavy duty releasable cable ties feature an extended pawl which allows for simple and quick release of the ties.

RT150 Heavy Duty Releasable Cable Ties

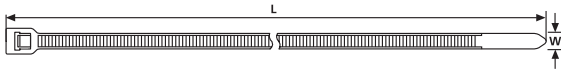

Material Data	
Material	Polyamide 6.6 (PA66)
Operating Temperature	-40 °F to +185 °F (-40 °C to +85 °C) continuous
Flammability	UL94 V2



Product Selection			Min. Tensile Strength	Length (L)	Max. Ø Bundle	Width (W)	Color	Pkg. Qty.
Article No.	Part No.	Type						
115-00036	RT150REPOX2	RT150REP	175 lbs (780)	15.35" (390)	4" (105)	.346" (8.8)	Black	25
115-00037	RT150MEPOX2	RT150MEP	175 lbs (780)	21.06" (535)	5.90" (150)	.346" (8.8)	Black	25
115-00038	RT150LEPOX2	RT150LEP	175 lbs (780)	32.28" (820)	9.65" (245)	.346" (8.8)	Black	25

Dimensions are approximate and subject to technical changes. Use **Part No.** for ordering and **Type** for specification purposes.

RT250 Heavy Duty Releasable Cable Ties



Material Data	
Material	Polyamide 6.6 (PA66)
Operating Temperature	-40 °F to +185 °F (-40 °C to +85 °C) continuous
Flammability	UL94 V2



Product Selection			Min. Tensile Strength	Length (L)	Max. Ø Bundle	Width (W)	Color	Pkg. Qty.
Article No.	Part No.	Type						
RT250S								
131-75819	RT250S9X2	RT250S	250 lbs (1115)	9.05" (230)	2.17" (55)	.49" (12.5)	Natural	25
115-41800	RT250S0X2	RT250S	250 lbs (1115)	9.05" (230)	2.17" (55)	.49" (12.5)	Black	25
RT250R								
131-75019	RT250R9X2	RT250R	250 lbs (1115)	20.47" (520)	5.71" (145)	.49" (12.5)	Natural	25
115-41300	RT250R0X2	RT250R	250 lbs (1115)	20.47" (520)	5.71" (145)	.49" (12.5)	Black	25
RT250M								
131-75619	RT250M9X2	RT250M	250 lbs (1115)	22.24" (565)	5.90" (150)	.49" (12.5)	Natural	25
131-75610	RT250M0X2	RT250M	250 lbs (1115)	22.24" (565)	5.90" (150)	.49" (12.5)	Black	25
RT250I								
131-75219	RT250I9X2	RT250I	250 lbs (1115)	28.54" (725)	8.00" (203)	.49" (12.5)	Natural	25
115-41401	RT250I0X2	RT250I	250 lbs (1115)	28.54" (725)	8.00" (203)	.49" (12.5)	Black	25
RT250L								
131-75419	RT250L9X2	RT250L	250 lbs (1115)	34.65" (880)	10.00" (254)	.49" (12.5)	Natural	25
115-41500	RT250L0X2	RT250L	250 lbs (1115)	34.65" (880)	10.00" (254)	.49" (12.5)	Black	25
RT250XL								
131-75519	RT250XL9X2	RT250XL	250 lbs (1115)	40" (1016.0)	12" (304.8)	.49" (12.5)	Natural	25
131-75510	RT250XL0X2	RT250XL	250 lbs (1115)	40" (1016.0)	12" (304.8)	.49" (12.5)	Black	25

Dimensions are approximate and subject to technical changes. Use **Part No.** for ordering and **Type** for specification purposes.



Heavy Duty Releasable Cable Ties

RT255 Heavy Duty Releasable Ties

Material Data	
Material	Polyamide 6.6 high impact modified, heat stabilized (PA66HIRHS)
Operating Temperature	-40 °F to +230 °F (-40 °C to +110 °C) continuous
Flammability	UL94 HB

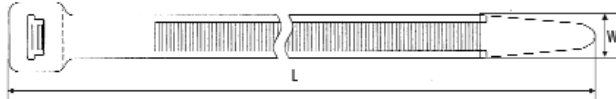

Product Selection			Min. Tensile Strength	Length (L)	Max. Ø Bundle	Width (W)	Color	Pkg. Qty.
Article No.	Part No.	Type						
115-01200	RT255S0HIRX2	RT255S	250 lbs (1112)	8.86" (225)	2.16" (55)	.49" (12.5)	Black	25
115-01300	RT255R0HIRX2	RT255R	250 lbs (1112)	20.28" (515)	5.71" (145)	.49" (12.5)	Black	25
115-01400	RT255M0HIRX2	RT255M	250 lbs (1112)	22.05" (560)	6.30" (160)	.49" (12.5)	Black	25

Dimensions are approximate and subject to technical changes. Use **Part No.** for ordering and **Type** for specification purposes.

SR255 Heavy Duty Sub-Releasable Ties

The SR255 series releasable heavy duty cable tie offers a release that is lower than the head of the cable tie, facilitating easy installation with the use of a HellermannTyton cable tie tool.

Material Data	
Material	Polyamide 6.6 high impact modified, heat stabilized (PA66HIRHS)
Operating Temperature	-40 °F to +230 °F (-40 °C to +110 °C) continuous
Flammability	UL94 HB

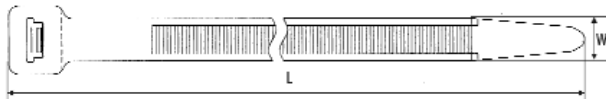

Product Selection			Min. Tensile Strength	Length (L)	Max. Ø Bundle	Width (W)	Color	Pkg. Qty.
Article No.	Part No.	Type						
115-42002	SR255S0HIHSUVX2	SR255S	250 lbs (1112)	8.86" (225)	2.16" (50)	.49" (12.5)	Black	25
115-42101	SR255X0HIHSUVX2	SR255X	250 lbs (1112)	14" (372)	3.94" (100)	.49" (12.5)	Black	25

Installation tools - MK9, MK9HT, MK9P. Dimensions are approximate and subject to technical changes. Use **Part No.** for ordering and **Type** for specification purposes.

Speedy Tie

An entirely new design in cable management, the SpeedyTie is a fully re-usable, easily releasable lashing tie. The SpeedyTie's unique design allows it to be released with one hand.

- Just one click to tie and untie
- Fully re-usable
- Once applied, the tail can be neatly tucked away for added safety
- Highly visible yellow color — also available in black, high impact modified material
- Versatile design allows use for multiple applications

The SpeedyTie is a versatile tool for countless applications:

- Electrical Contractors
- Heating & Ventilation Contractors
- Residential Construction
- General and Heavy Industry
- Packaging
- Tubing and Pipe Bundling
- An "Extra Hand" for Overhead Installations
- In Plant Transfer of Products

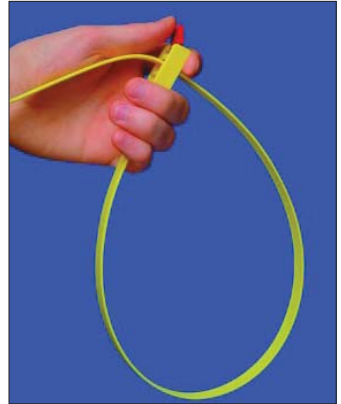

SpeedyTie - Quick and easy.



Speedy Tie is particularly suited for temporary but safe bundling or fixing.

Material Data	
Material	Polyamide 6.6 (PA66)
Color	Yellow , Red
Operating Temperature	-40 °F to +185 °F (-40 °C to +85 °C) continuous
Flammability	UL94 V2



Packaging Configurations

Distributor Packs

- Printed bag with a hang hole
- Display box
- 60 SpeedyTies - 12 bags of 5

OEM Packs

- Plain bag (no hang hole)
- Standard box
- 300 SpeedyTies - 12 bags of 25



Distributor Pack - point of purchase display for the SpeedyTie.

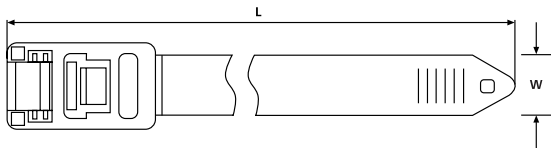

Product Selection			Description	Min. Tensile Strength	Length (L)	Max. Ø Bundle	Width (W)	Pkg. Qty.	Carton Qty.
Article No.	Part No.	Type		lbs. (N)	in. (mm)	in. (mm)	in. (mm)		
115-00001	RTT750HR.NX900	RTT750HR	Distributor Pack - order in carton qty. only	200 lbs (888)	29.52" (750)	8.27" (210)	.51" (13)	5	60
115-00000	RTT750HR.NX1P	RTT750HR	OEM Pack - order in carton qty. only	200 lbs (888)	29.52" (750)	8.27" (210)	.51" (13)	25	300

Dimensions are approximate and subject to technical changes. Use **Part No.** for ordering and **Type** for specification purposes.

Stainless Steel Cable Ties

HellermannTyton's stainless steel ties are designed to secure hoses, cables, poles, pipes, and more when harsh environmental conditions may adversely affect the bundling application. Used where corrosion, vibration, weathering, radiation, and temperature extremes are a concern, HellermannTyton's stainless steel ties can be used in virtually any indoor, outdoor, and underground application.

MK9SST Stainless Steel Cable Tie Installation Tool

Product Selection					
Article No.	Part No.	Type	Description	Cable Tie Series	Pkg. Qty.
110-95000	MK9SST	MK9SST	Adapted for use with stainless steel ties, the MK9 Stainless Steel tool retains the same design features as the MK9 series. The MK9SST accommodates all HellermannTyton stainless steel ties. Comes standard with padded foam grips for comfort and control and a hook for hanging on a belt or tether.	All MBT Series for both 304 and 316 materials	1

304 Material

Grade 304 material is commonly used for stainless steel bundling applications and suits most general purpose requirements. It features the ability to withstand most environmental conditions, particularly in applications where vibration, general weathering, radiation and temperature extremes are a concern.

- Self locking, ball bearing mechanism for quick and easy installation, either by hand or by tensioning tool
- Fully enclosed head does not allow dirt or grit to interfere with locking mechanism
- High tensile strength option for added strength and safety on heavy duty applications



HellermannTyton's MK9SST tool is durable and lightweight, offering superior stainless steel cable tie installation.

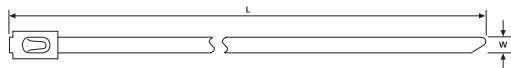

Material Data	
Material	Stainless Steel Type SS304 (SS304)
Operating Temperature	-112 °F to +1000 °F (-80 °C to +538 °C)



Product Selection											
Article No.	Part No.	Type	Min. Tensile Strength		Length (L)		Max. Ø Bundle		Width (W)	Pkg. Qty.	
			lbs.	(N)	in.	(mm)	in.	(mm)			in.
150 lb. Stainless Steel Ties											
111-93058	MBT5S-S	MBT5SS	150 lbs	(670)	5.0"	(127)	1"	(25)	.18"	(4.6)	100
111-93088	MBT8S-S	MBT8SS	150 lbs	(670)	7.9"	(201)	2"	(50)	.18"	(4.6)	100
111-93148	MBT14S-S	MBT14SS	150 lbs	(670)	14.3"	(362)	4"	(102)	.18"	(4.6)	100
111-93208	MBT20S-S	MBT20SS	150 lbs	(670)	20.5"	(521)	6"	(152)	.18"	(4.6)	100
111-93278	MBT27S-S	MBT27SS	150 lbs	(670)	26.8"	(681)	8"	(203)	.18"	(4.6)	100
111-93338	MBT33S-S	MBT33SS	150 lbs	(670)	33"	(838)	10"	(254)	.18"	(4.6)	100
250 lb. Stainless Steel Ties											
111-94088	MBT8H-S	MBT8HS	250 lbs	(1115)	7.9"	(201)	2"	(50)	.31"	(7.9)	50
111-94148	MBT14H-S	MBT14HS	250 lbs	(1115)	14.3"	(362)	4"	(102)	.31"	(7.9)	50
111-94208	MBT20H-S	MBT20HS	250 lbs	(1115)	20.5"	(521)	6"	(152)	.31"	(7.9)	50
111-94278	MBT27H-S	MBT27HS	250 lbs	(1115)	26.8"	(681)	8"	(203)	.31"	(7.9)	50
111-94338	MBT33H-S	MBT33HS	250 lbs	(1115)	33"	(838)	10"	(254)	.31"	(7.9)	50

Installation tools for the above cable ties - MK9SST. Dimensions are approximate and subject to technical changes. Use **Part No.** for ordering and **Type** for specification purposes. Stainless steel ties and materials should be tested thoroughly under end use conditions to determine suitability for the application.

Stainless Steel Cable Ties (continued)

316 Material

Grade 316 material is highly resistant to corrosion and widely used in marine environments where chemicals, salts, acids, and temperature extremes may affect the bundling application. MBT stainless steel ties in 316 steel material are also available with a nylon 11 protective coating. This coating creates a barrier and protectant from chemical reactions of dissimilar metals.



- Self locking, ball bearing mechanism for quick and easy installation, either by hand or by tensioning tool
- Fully enclosed head does not allow dirt or grit to interfere with locking mechanism
- High tensile strength option available for added strength and safety on heavy duty applications

Material Data	
Material	Stainless Steel Type SS316 (SS316)
Operating Temperature	-112 °F to +1000 °F (-80 °C to +538 °C)

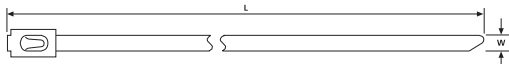

Product Selection			Min. Tensile Strength	Length (L)	Max. Ø Bundle	Width (W)	Pkg. Qty.
Article No.	Part No.	Type					
150 lb. Stainless Steel Ties							
111-93959	MBT5S	MBT5S	150 lbs (670)	5.0" (127)	1.0" (25.4)	.18" (4.6)	100
111-93089	MBT8S	MBT8S	150 lbs (670)	7.9" (201)	2.0" (50)	.18" (4.6)	100
111-93149	MBT14S	MBT14S	150 lbs (670)	14.3" (362)	4.0" (102)	.18" (4.6)	100
111-93209	MBT20S	MBT20S	150 lbs (670)	20.5" (521)	6.0" (152)	.18" (4.6)	100
111-93279	MBT27S	MBT27S	150 lbs (670)	26.8" (681)	8.0" (203)	.18" (4.6)	100
111-93339	MBT33S	MBT33S	150 lbs (670)	33.0" (838)	10.0" (254)	.18" (4.6)	100
250 lb. Stainless Steel Ties							
111-94089	MBT8H	MBT8H	250 lbs (1115)	7.9" (201)	2.0" (50.8)	.31" (7.9)	50
111-94149	MBT14H	MBT14H	250 lbs (1115)	14.3" (362)	4.0" (102)	.31" (7.9)	50
111-94209	MBT20H	MBT20H	250 lbs (1115)	20.5" (521)	6.0" (152)	.31" (7.9)	50
111-94279	MBT27H	MBT27H	250 lbs (1115)	26.8" (681)	8.0" (203)	.31" (7.9)	50
111-94339	MBT33H	MBT33H	250 lbs (1115)	33.0" (838)	10.0" (254)	.31" (7.9)	50

Installation tools for the above cable ties - MK9SST. Dimensions are approximate and subject to technical changes. Use **Part No.** for ordering and **Type** for specification purposes. Stainless steel ties and materials should be tested thoroughly under end use conditions to determine suitability for the application.