

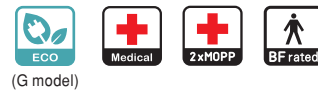

(Standard)



(Optional)



■ Features

- 5"×3" compact size
- Medical safety approved (2 x MOPP) according to ANSI/AAMI ES60601-1 and IEC/EN 60601-1
- Suitable for BF application with appropriate system consideration
- 100W convection, 145W force air
- EMI Class B for Class I configuration
- No load power consumption < 0.75W by PS-ON control (G model)
- Extremely low leakage current
- 5Vdc standby output, Power Good, Power Fail
- Protections: Short circuit / Overload / Over voltage / Over temperature
- Lifetime > 85K hours
- 3 years warranty

■ Applications

- Oral irrigator
- Hemodialysis machine
- Medical monitors
- Sleep apnea devices
- Pumps machine

■ Description

RPT(G)-160 is a 145W highly reliable PCB type medical power supply with a high power density on the 5" by 3" footprint. It accepts 90~264VAC input and offers triple output voltages. The extremely low leakage current is less than 160μA. In addition, it conforms to international medical regulations (2*MOPP) and EMC EN55011, perfectly fitting all kinds of BF rated "patient contact" medical system equipment. RPT(G)-160 series also offers the enclosed style model [RPT(G)-160-C].

■ Model Encoding

RPT **G** - 160 **A** -C

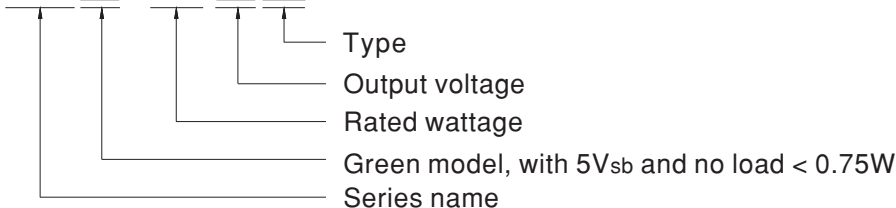

Type	Description	Note
Blank	PCB Type	In Stock
C	Enclosed casing type	Optional

SPECIFICATION for PCB Type(standard)

MODEL		RPT(G)-160A			RPT(G)-160B			RPT(G)-160C			RPT(G)-160D			
OUTPUT	OUTPUT NUMBER	CH1	CH2	CH3	CH1	CH2	CH3	CH1	CH2	CH3	CH1	CH2	CH3	
	DC VOLTAGE	5V	12V	-5V	5V	12V	-12V	5V	15V	-15V	5V	12V	24V	
	CURRENT	RATED (20.5CFM)	14A	5.5A	1A	14A	5A	1A	14A	3.6A	1A	11A	5A	1.2A
		RANGE (20.5CFM)	0.6 ~ 14A	0.2 ~ 5.5A	0.1 ~ 1A	0.6 ~ 14A	0.2 ~ 5A	0.1 ~ 1A	0.6 ~ 14A	0.1 ~ 3.6A	0.1 ~ 1A	0.3 ~ 11A	0.2 ~ 5A	0.15 ~ 1.2A
		RANGE (convection)	0.6 ~ 9A	0.2 ~ 3.8A	0.1 ~ 0.6A	0.6 ~ 9A	0.2 ~ 3.4A	0.1 ~ 0.8A	0.6 ~ 9A	0.1 ~ 2.6A	0.1 ~ 0.8A	0.3 ~ 8A	0.2 ~ 2.6A	0.15 ~ 1A
	RATED POWER	20.5CFM Note.2	145W			146W			143W			147.8W		
		Convection Note.3	98.6W			98.4W			99W			98.2W		
	RIPPLE & NOISE (max.) Note.4	60mVp-p	80mVp-p	120mVp-p	60mVp-p	100mVp-p	100mVp-p	60mVp-p	80mVp-p	100mVp-p	80mVp-p	100mVp-p	120mVp-p	
	VOLTAGE ADJ. RANGE	CH1:5 ~ 5.5V												
	VOLTAGE TOLERANCE Note.5	±2.0%	±5.0%	-5,+7%	±2.0%	±5.0%	-4,+5%	±2.0%	±4.0%	±8.0%	±2.0%	±5.0%	+7,-5%	
	LINE REGULATION	±0.5%	±1.0%	±1.0%	±0.5%	±1.0%	±1.0%	±0.5%	±1.0%	±1.0%	±0.5%	±1.0%	±1.0%	
	LOAD REGULATION	±1.5%	±3.0%	-5,+6%	±1.5%	±3.0%	-4,+5%	±2.0%	±3.0%	±8.0%	±1.5%	±3.0%	-3,+4%	
SETUP, RISE TIME	1800ms, 30ms/230VAC 3500ms, 30ms/115VAC at full load													
HOLD UP TIME (Typ.)	30ms/230VAC 20ms/115VAC at full load													
INPUT	VOLTAGE RANGE Note.6	90 ~ 264VAC 127 ~ 370VDC												
	FREQUENCY RANGE	47 ~ 63Hz												
	POWER FACTOR (Typ.)	PF>0.93/230VAC PF>0.98/115VAC at full load												
	EFFICIENCY (Typ.)	84%			84%			83%			83%			
	AC CURRENT (Typ.)	1.8A/115VAC 0.9A/230VAC												
	INRUSH CURRENT (Typ.)	COLD START 35A/115VAC 70A/230VAC												
	LEAKAGE CURRENT (max.) Note.7	Earth leakage current < 160 μA/264VAC , Touch current < 100 μA/264VAC												
PROTECTION	OVERLOAD	105 ~ 135% rated output power Protection type : Hiccup mode, recovers automatically after fault condition is removed												
	OVER VOLTAGE	Ch1: 5.7 ~ 6.8V Protection type : Shut down o/p voltage, re-power on to recover												
	OVER TEMPERATURE	TSW1: Shut down o/p voltage, recovers automatically after temperature goes down TSW2: Shut down o/p voltage, re-power on to recover												
FUNCTION	5V STANDBY (G model)	5Vsb : 5V@0.6A without fan, 0.8A with fan 20.5CFM ; Tolerance ± 2%, ripple : 50mVp-p(max.)												
	PS-ON INPUT SIGNAL (G model)	Power on: PS-ON = "Hi" or " > 2 ~ 5V" ; Power off: PS-ON = "Low" or " < 0 ~ 0.5V"												
	POWER GOOD / POWER FAIL	500ms>PG>10ms PF>1ms												
ENVIRONMENT	WORKING TEMP.	-20 ~ +70°C (Refer to "Derating Curve")												
	WORKING HUMIDITY	20 ~ 90% RH non-condensing												
	STORAGE TEMP., HUMIDITY	-40 ~ +85°C, 10 ~ 95% RH non-condensing												
	TEMP. COEFFICIENT	±0.03%/°C (0 ~ 50°C)												
	VIBRATION	10 ~ 500Hz, 2G 10min./1cycle, 60min. each along X, Y, Z axes												
	OPERATING ALTITUDE Note.8	3000 meters												
SAFETY & EMC (Note 10)	SAFETY STANDARDS	IEC60601-1, EAC TP TC 004,UL ANSI/AAMI ES60601-1, CAN/CSA-C22.2 No. 60601-1:14 - Edition 3 approved, TUV EN60601-1 approved												
	ISOLATION LEVEL	Primary-Secondary: 2xMOPP, Primary-Earth:1xMOPP, Secondary-Earth:1xMOPP												
	WITHSTAND VOLTAGE	I/P-O/P:4KVAC I/P-FG:2KVAC O/P-FG:1.5KVAC												
	ISOLATION RESISTANCE	I/P-O/P, I/P-FG, O/P-FG:100M Ohms / 500VDC / 25°C / 70% RH												
	EMC EMISSION	Parameter		Standard					Test Level / Note					
		Conducted emission		EN55011 (CISPR11)					Class B					
		Radiated emission		EN55011 (CISPR11)					Class B					
		Harmonic current		EN61000-3-2					Class A					
	Voltage flicker		EN61000-3-3					-----						
	EMC IMMUNITY	EN60601-1-2												
		Parameter		Standard					Test Level / Note					
		ESD		EN61000-4-2					Level 4, 15KV air ; Level 4, 8KV contact					
RF field susceptibility		EN61000-4-3					Level 3, 10V/m(80MHz~2.7GHz) Table 9, 9~28V/m(385MHz~5.78GHz)							
EFT bursts		EN61000-4-4					Level 3, 2KV							
Surge susceptibility		EN61000-4-5					Level 3, 2KV/Line-FG ; 1KV/Line-Line							
Conducted susceptibility		EN61000-4-6					Level 3, 10V							
Magnetic field immunity		EN61000-4-8					Level 4, 30A/m							
Voltage dip, interruption		EN61000-4-11					100% dip 1 periods, 30% dip 25 periods, 100% interruptions 250 periods							
OTHERS	MTBF	191.4K hrs min. MIL-HDBK-217F (25°C)												
	DIMENSION (L*W*H)	PCB type: 127*76.2*34.6mm or 5"*3"*1.36" inch												
	PACKING	0.33Kg; 36pcs/12.9Kg/0.79CUFT												

NOTE

- All parameters NOT specially mentioned are measured at 230VAC input, rated load and 25°C of ambient temperature.
- The rated power includes 5Vsb @ 0.8A.
- The rated power includes 5Vsb @ 0.6A.
- Ripple & noise are measured at 20MHz of bandwidth by using a 12" twisted pair-wire terminated with a 0.1 μf & 47 μf parallel capacitor.
- Tolerance : includes set up tolerance, line regulation and load regulation.
- Derating may be needed under low input voltages. Please check the derating curve for more details.
- Touch current was measured from primary input to DC output.
- The ambient temperature derating of 3.5°C/1000m with fanless models and of 5°C/1000m with fan models for operating altitude higher than 2000m(6500ft).
- HS1,HS2 & HS3 can not be shorted.
- The power supply is considered a component which will be installed into a final equipment. All the EMC tests are been executed by mounting the unit on a 360mm*360mm metal plate with 1mm of thickness. The final equipment must be re-confirmed that it still meets EMC directives. For guidance on how to perform these EMC tests, please refer to "EMI testing of component power supplies." (as available on <http://www.meanwell.com>)

SPECIFICATION for Enclosed Type(optional)

MODEL		RPT(G)-160A-C			RPT(G)-160B-C			RPT(G)-160C-C			RPT(G)-160D-C				
OUTPUT NUMBER		CH1	CH2	CH3	CH1	CH2	CH3	CH1	CH2	CH3	CH1	CH2	CH3		
OUTPUT		DC VOLTAGE		5V	12V	-5V	5V	12V	-12V	5V	15V	-15V	5V	12V	24V
	CURRENT	RATED (20.5CFM)		13.3A	5.2A	0.95A	13.3A	4.8A	0.95A	13.3A	3.4A	0.95A	10.5A	4.8A	1.14A
		RANGE (20.5CFM)		0.6 ~ 13.3A	0.2 ~ 5.2A	0.1 ~ 0.95A	0.6 ~ 13.3A	0.2 ~ 4.8A	0.1 ~ 0.95A	0.6 ~ 13.3A	0.1 ~ 3.4A	0.1 ~ 0.95A	0.3 ~ 10.5A	0.2 ~ 4.8A	0.15 ~ 1.14A
		RANGE (convection)		0.6 ~ 8.5A	0.2 ~ 3.6A	0.1 ~ 0.57A	0.6 ~ 8.5A	0.2 ~ 3.2A	0.1 ~ 0.76A	0.6 ~ 8.5A	0.1 ~ 2.5A	0.1 ~ 0.76A	0.3 ~ 7.6A	0.2 ~ 2.5A	0.15 ~ 0.95A
	RATED POWER	20.5CFM Note.2		137.7W			139.5W			135.8W			141.5W		
		Convection Note.3		91.6W			93W			94.4W			93.8W		
RIPPLE & NOISE (max.) Note.4		60mVp-p	80mVp-p	120mVp-p	60mVp-p	100mVp-p	100mVp-p	60mVp-p	80mVp-p	100mVp-p	80mVp-p	100mVp-p	100mVp-p	100mVp-p	120mVp-p
VOLTAGE ADJ. RANGE		CH1:5 ~ 5.5V													
VOLTAGE TOLERANCE Note.5		±2.0%	±5.0%	-5,+7%	±2.0%	±5.0%	-4,+5%	±2.0%	±4.0%	±8.0%	±2.0%	±5.0%	+7,-5%		
LINE REGULATION		±0.5%	±1.0%	±1.0%	±0.5%	±1.0%	±1.0%	±0.5%	±1.0%	±1.0%	±0.5%	±1.0%	±1.0%		
LOAD REGULATION		±1.5%	±3.0%	-5,+6%	±1.5%	±3.0%	-4,+5%	±2.0%	±3.0%	±8.0%	±1.5%	±3.0%	-3,+4%		
SETUP, RISE TIME		1800ms, 30ms/230VAC			3500ms, 30ms/115VAC at full load										
HOLD UP TIME (Typ.)		30ms/230VAC			20ms/115VAC at full load										
INPUT		VOLTAGE RANGE Note.6		90 ~ 264VAC		127 ~ 370VDC									
		FREQUENCY RANGE		47 ~ 63Hz											
		POWER FACTOR (Typ.)		PF>0.93/230VAC			PF>0.98/115VAC at full load								
		EFFICIENCY (Typ.)		84%			84%			83%			83%		
		AC CURRENT (Typ.)		1.8A/115VAC		0.9A/230VAC									
		INRUSH CURRENT (Typ.)		COLD START 35A/115VAC			70A/230VAC								
		LEAKAGE CURRENT (max.) Note.7		Earth leakage current < 160 μA/264VAC , Touch current < 100 μA/264VAC											
PROTECTION		OVERLOAD		105 ~ 135% rated output power Protection type : Hiccup mode, recovers automatically after fault condition is removed											
		OVER VOLTAGE		Ch1: 5.7 ~ 6.8V Protection type : Shut down o/p voltage, re-power on to recover											
		OVER TEMPERATURE		TSW1: Shut down o/p voltage, recovers automatically after temperature goes down TSW2: Shut down o/p voltage, re-power on to recover											
FUNCTION		5V STANDBY (G model)		5Vsb : 5V@0.6A without fan, 0.8A with fan 20.5CFM ; Tolerance ± 2%, ripple : 50mVp-p(max.)											
		PS-ON INPUT SIGNAL (G model)		Power on: PS-ON = "Hi" or "> 2 ~ 5V" ; Power off: PS-ON = "Low" or "< 0 ~ 0.5V"											
		POWER GOOD / POWER FAIL		500ms>PG>10ms			PF>1ms								
ENVIRONMENT		WORKING TEMP.		-20 ~ +70°C (Refer to "Derating Curve")											
		WORKING HUMIDITY		20 ~ 90% RH non-condensing											
		STORAGE TEMP., HUMIDITY		-40 ~ +85°C , 10 ~ 95% RH non-condensing											
		TEMP. COEFFICIENT		±0.03%/°C (0 ~ 50°C)											
		VIBRATION		10 ~ 500Hz, 2G 10min./1cycle, 60min. each along X, Y, Z axes											
		OPERATING ALTITUDE Note.8		3000 meters											
SAFETY & EMC (Note 10)		SAFETY STANDARDS		Design refer to IEC60601-1, EAC TP TC 004, UL ANSI/AAMI ES60601-1, CAN/CSA-C22.2 No. 60601-1:14 - Edition 3 approved, TUV EN60601-1(Pending for CB/TUV)											
		ISOLATION LEVEL		Primary-Secondary: 2xMOPP, Primary-Earth:1xMOPP, Secondary-Earth:1xMOPP											
		WITHSTAND VOLTAGE		I/P-O/P:4KVAC			I/P-FG:2KVAC			O/P-FG:1.5KVAC					
		ISOLATION RESISTANCE		I/P-O/P, I/P-FG, O/P-FG:100M Ohms / 500VDC / 25°C / 70% RH											
		EMC EMISSION		Parameter		Standard		Test Level / Note							
				Conducted emission		EN55011 (CISPR11)		Class B							
				Radiated emission		EN55011 (CISPR11)		Class B							
				Harmonic current		EN61000-3-2		Class A							
				Voltage flicker		EN61000-3-3		-----							
		EMC IMMUNITY		Parameter		Standard		Test Level / Note							
				ESD		EN61000-4-2		Level 4, 15KV air ; Level 4, 8KV contact							
				RF field susceptibility		EN61000-4-3		Level 3, 10V/m(80MHz~2.7GHz) Table 9, 9~28V/m(385MHz~5.78GHz)							
				EFT bursts		EN61000-4-4		Level 3, 2KV							
				Surge susceptibility		EN61000-4-5		Level 3, 2KV/Line-FG ; 1KV/Line-Line							
				Conducted susceptibility		EN61000-4-6		Level 3, 10V							
				Magnetic field immunity		EN61000-4-8		Level 4, 30A/m							
				Voltage dip, interruption		EN61000-4-11		100% dip 1 periods, 30% dip 25 periods, 100% interruptions 250 periods							
OTHERS		MTBF		191.4K hrs min. MIL-HDBK-217F (25°C)											
		DIMENSION		Enclosed type: 130*86*43mm or 5.11"*3.39"*1.69" inch											
		PACKING		0.49Kg; 24pcs/12.8Kg/0.77CUFT											
NOTE		<ol style="list-style-type: none"> All parameters NOT specially mentioned are measured at 230VAC input, rated load and 25°C of ambient temperature. The rated power includes 5Vsb @ 0.8A. The rated power includes 5Vsb @ 0.6A. Ripple & noise are measured at 20MHz of bandwidth by using a 12" twisted pair-wire terminated with a 0.1μf & 47μf parallel capacitor. Tolerance : includes set up tolerance, line regulation and load regulation. Derating may be needed under low input voltages. Please check the derating curve for more details. Touch current was measured from primary input to DC output. The ambient temperature derating of 3.5°C/1000m with fanless models and of 5°C/1000m with fan models for operating altitude higher than 2000m(6500ft). HS1,HS2 & HS3 can not be shorted. The power supply is considered a component which will be installed into a final equipment. All the EMC tests are been executed by mounting the unit on a 360mm*360mm metal plate with 1mm of thickness. The final equipment must be re-confirmed that it still meets EMC directives. For guidance on how to perform these EMC tests, please refer to "EMI testing of component power supplies." (as available on http://www.meanwell.com) 													

■ Block Diagram

fosc :100KHz

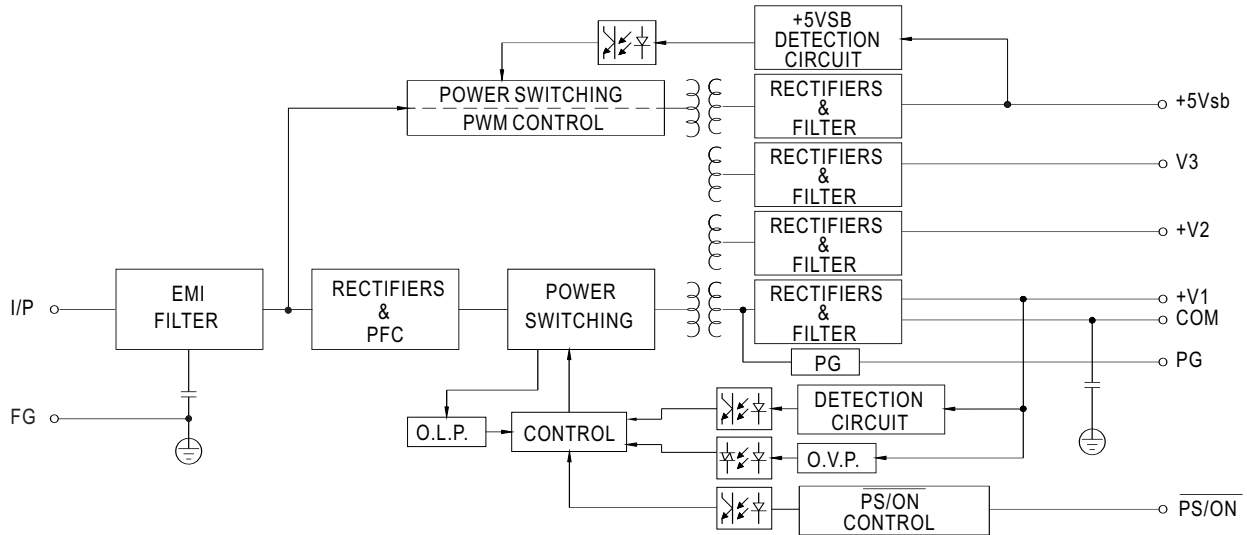

■ Derating Curve

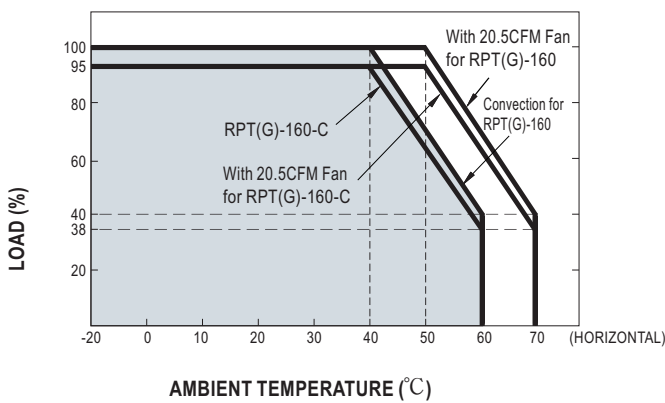

■ Output Derating VS Input Voltage

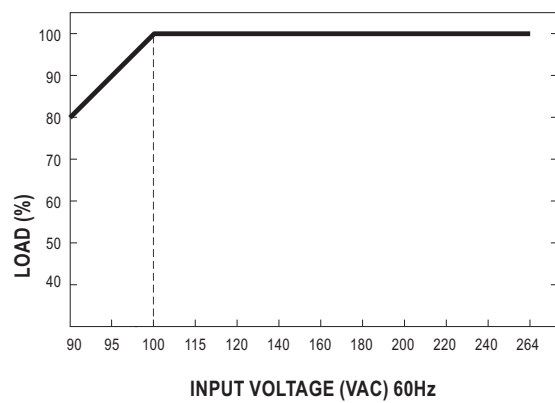

■ Mechanical Specification

Unit:mm

● PCB Type: RPT-160(G)

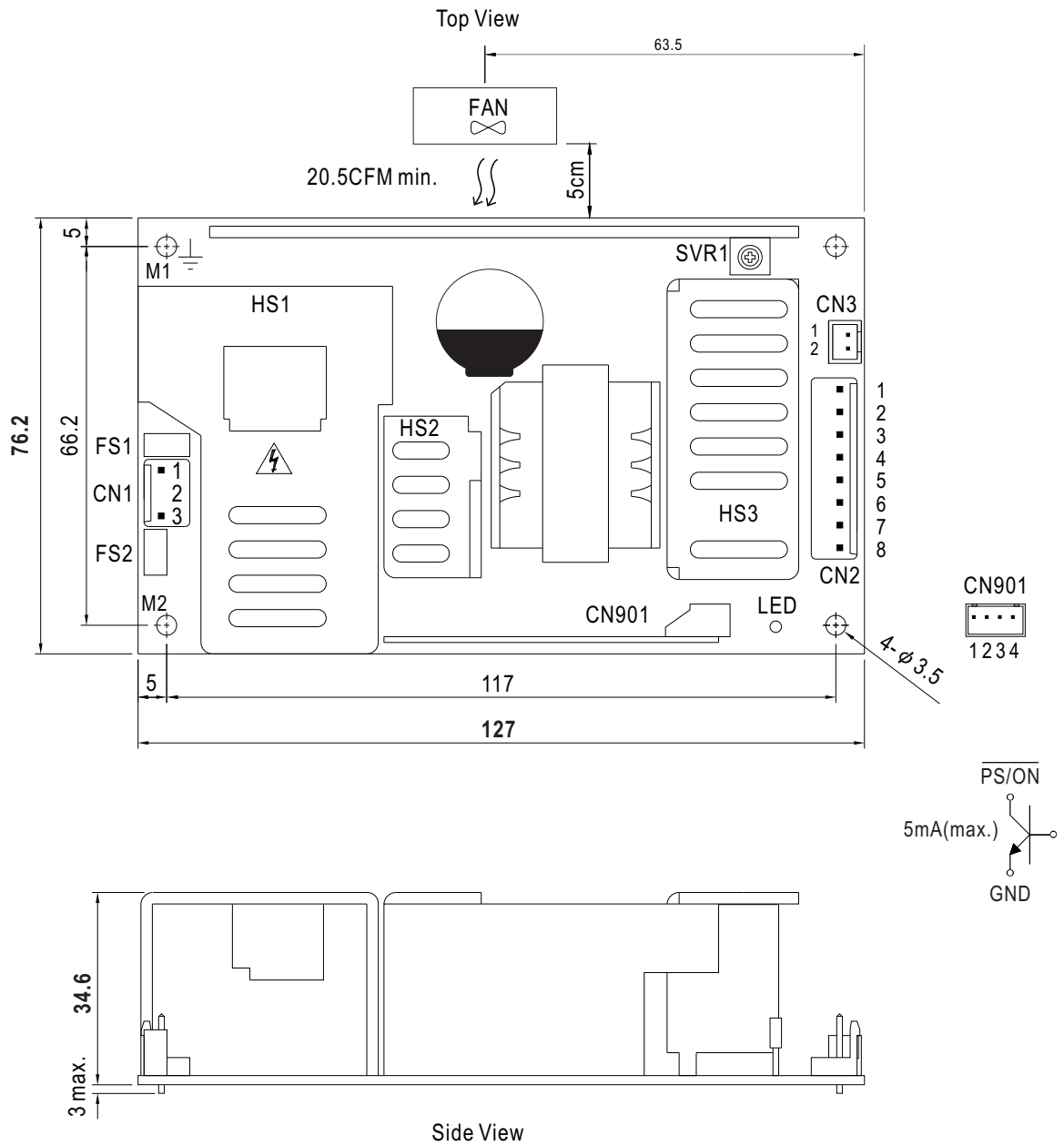

● Enclosed Type: RPT-160(G)-C

Case No.247A Unit:mm

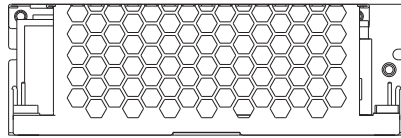

Side View

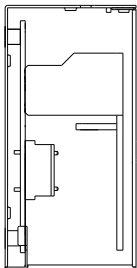
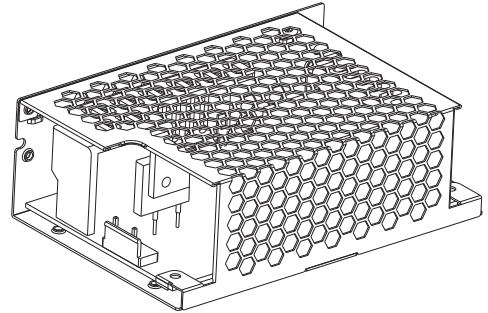

Side View

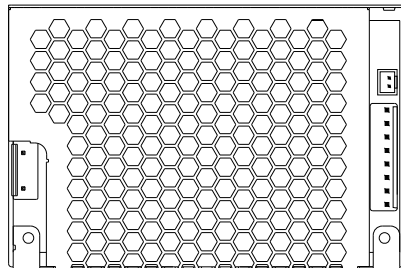

Top View

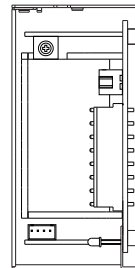
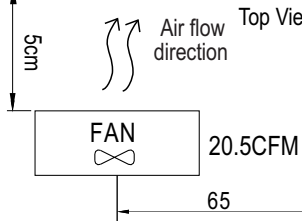

Side View

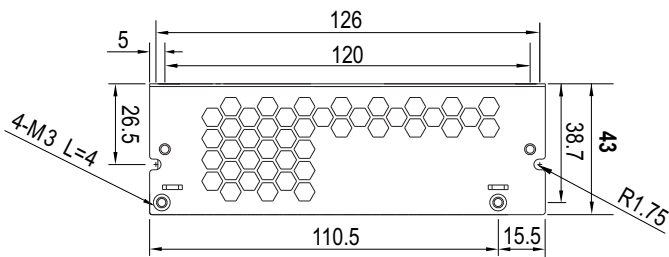

Side View

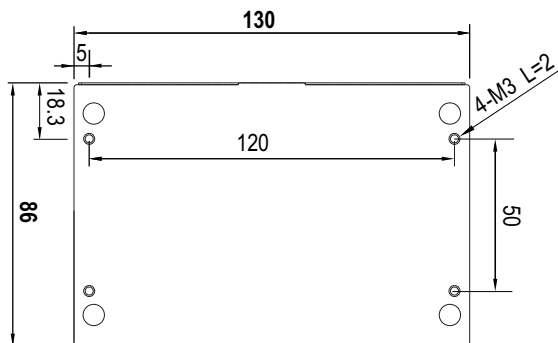

Bottom View

※ Mounting Instruction

Hole No.	Recommended Screw Size	MAX. Penetration Depth L	Recommended mounting torque
① ②	M3	2mm	4~6Kgf-cm

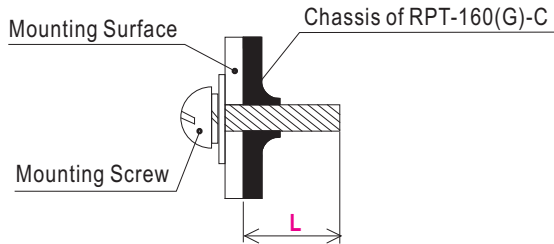

AC Input Connector (CN1) : JST B3P-VH or equivalent

Pin No.	Assignment	Mating Housing	Terminal
1	AC/L	JST VHR or equivalent	JST SVH-21T-P1.1 or equivalent
2	No Pin		
3	AC/N		

DC Output Connector (CN2) : JST B8P-VH or equivalent

Pin No.	Assignment	Mating Housing	Terminal
1,2,3,4	COM	JST VHR or equivalent	JST SVH-21T-P1.1 or equivalent
5,6	CH1		
7	CH2		
8	CH3		

Power Good Connector(CN3):JST B2B-XH or equivalent

Pin No.	Status	Mating Housing	Terminal
1	PG	JST XHP or equivalent	JST SXH-001T-P0.6 or equivalent
2	GND		

5VSB Connector(CN901) : JST B-XH or equivalent

Pin No.	Assignment	Mating Housing	Terminal
1	PS/ON	JST XHP or equivalent	JST SXH-001T or equivalent
2,4	GND		
3	5VSB		

- ⚠ 1.HS1,HS2,HS3 can not be shorted
2.M1 and M2 are Safety ground and should all be grounded.

- ※ Note: 1. The PCB type (Blank Type) model delivers EMI Class B for both conducted emission and radiated emission for the power supply, when configured into either Class I (with FG).
2. The enclosed type (-C type) model is not suitable for configuration within a Class II (no FG) system, but suggested within a Class I (with FG) system.
3. Mounting Instruction for Enclosed type only.

■ INSTALLATION MANUAL

Please refer to : <http://www.meanwell.com/manual.html>