

Single-unit and dual-unit types suit a variety of controls

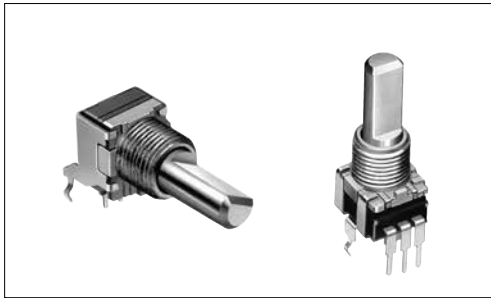

### Typical Specifications



Items	Specifications
Total resistance tolerance	±20%
Maximum operating voltage	50V AC, 10V DC
Total rotational angle	300° ±5°
Rotational torque	2 to 25mN·m
Operating life	15,000 cycles
Operating temperature range	-10°C to +70°C

### Product Line

Number of resistor elements	Mounting direction	Shaft type	Length of the shaft L <sub>1</sub> (mm)	Center detent	Total resistance (kΩ)	Resistance taper	Minimum order unit (pcs.)		Products No.	Drawing No.			
							Japan	Export					
Single-unit	Horizontal type	Flat	15	Without	10	15A	1,000	2,000	<b>RK09L1120A2S</b>	1			
				With	20	1B			<b>RK09L112003P</b>				
	Vertical type		12.5	Without	10	15A			<b>RK09L1120A69</b>	2			
									50		<b>RK09L1140A5E</b>		
			20		With	10					1B	<b>RK09L1140A66</b>	
									<b>RK09L1140A5P</b>				
			25	Without	5	100			<b>RK09L1140A2U</b>				
									<b>RK09L114001T</b>				
			Dual-unit	Horizontal type for tone	15	With			50		15A	<b>RK09L1140A65</b>	3
												<b>RK09L122002M</b>	
Horizontal type for vol.	25	Without		50	10	3B	<b>RK09L1220A1B</b>						
							<b>RK09L12B0A31</b>						
Vertical type for tone	15	With		50	10	1B	<b>RK09L12B0A3Z</b>						
							<b>RK09L124000Z</b>						
Vertical type for vol.	20	Without		10	15A	15A	<b>RK09L1240A12</b>	4					
							<b>RK09L12D0A1W</b>						
						<b>RK09L12D0A1T</b>							

### Note

Other varieties are also available. Refer to "Other Specifications" (P.308).

### Packing Specifications

Tray

Number of packages (pcs.)		Export package measurements (mm)
1 case /Japan	1 case /export packing	
1,000	2,000	479×369×181

Refer to P.308 for other specifications.  
 Refer to P.308 for attached parts.  
 Refer to P.309 for ordering products not listed.  
 Refer to P.343 for soldering conditions.

■ Dimensions

Unit:mm

No.	Photo	Style	PC board mounting hole dimensions (Viewed from mounting side)															
1	<p><b>Single-shaft, single-unit Horizontal type RK09L1120</b></p>	<table border="1"> <tr> <td><math>L_1</math></td> <td>15</td> <td>20</td> </tr> <tr> <td><math>L_B</math></td> <td>5</td> <td>7</td> </tr> <tr> <td><math>l_1</math></td> <td>7</td> <td>12</td> </tr> </table> <p>Shaft shown in full C.C.W position</p>	$L_1$	15	20	$L_B$	5	7	$l_1$	7	12							
$L_1$	15	20																
$L_B$	5	7																
$l_1$	7	12																
2	<p><b>Single-shaft, single-unit Vertical type RK09L1140</b></p>	<table border="1"> <tr> <td><math>L_1</math></td> <td>12.5</td> <td>15</td> <td>20</td> <td>25</td> </tr> <tr> <td><math>L_B</math></td> <td>5</td> <td>5</td> <td>7</td> <td>7</td> </tr> <tr> <td><math>l_1</math></td> <td>7</td> <td>7</td> <td>12</td> <td>12</td> </tr> </table> <p>Shaft shown in full C.C.W position</p>	$L_1$	12.5	15	20	25	$L_B$	5	5	7	7	$l_1$	7	7	12	12	
$L_1$	12.5	15	20	25														
$L_B$	5	5	7	7														
$l_1$	7	7	12	12														
3	<p><b>Single-shaft, dual-unit Horizontal type RK09L1220 (For tone) RK09L12B0 (For vol.)</b></p>	<table border="1"> <tr> <td><math>L_1</math></td> <td>15</td> <td>25</td> </tr> <tr> <td><math>L_B</math></td> <td>5</td> <td>7</td> </tr> <tr> <td><math>l_1</math></td> <td>7</td> <td>12</td> </tr> </table> <p>Shaft shown in full C.C.W position</p>	$L_1$	15	25	$L_B$	5	7	$l_1$	7	12							
$L_1$	15	25																
$L_B$	5	7																
$l_1$	7	12																
4	<p><b>Single-shaft, dual-unit Vertical type RK09L1240 (For tone) RK09L12D0 (For vol.)</b></p>	<table border="1"> <tr> <td><math>L_1</math></td> <td>15</td> <td>20</td> </tr> <tr> <td><math>L_B</math></td> <td>5</td> <td>7</td> </tr> <tr> <td><math>l_1</math></td> <td>7</td> <td>12</td> </tr> </table> <p>Shaft shown in full C.C.W position</p>	$L_1$	15	20	$L_B$	5	7	$l_1$	7	12							
$L_1$	15	20																
$L_B$	5	7																
$l_1$	7	12																

■ Dimensions of Bushing and Fixing Lug

Unit:mm

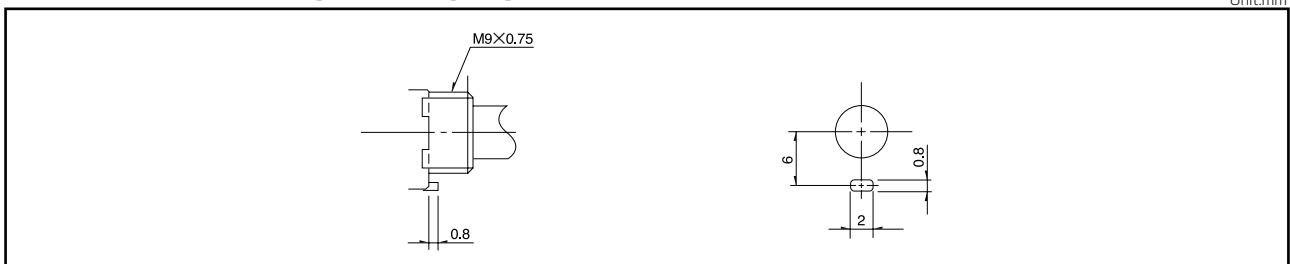

# 9mm Size Metal Shaft Snap-in Type / Other Specifications

In addition to the products listed, we can accommodate the follow specifications.

## Total Resistance Variety

Total resistance (k $\Omega$ )	5	10	20	50	100
--------------------------------	---	----	----	----	-----

## Resistance Taper

Resistance taper	15A	1B	3B	15C
------------------	-----	----	----	-----

## Shaft Variety

Unit:mm

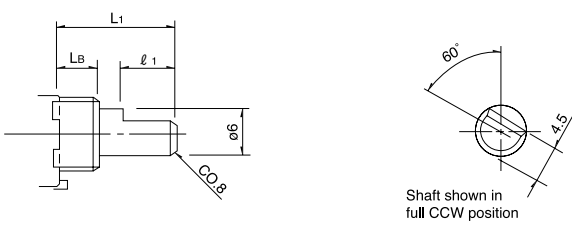

Detail dimensions

L <sub>1</sub>	L <sub>B</sub>	l <sub>1</sub>
12.5	5	7
15	5	7
17.5	5	7
20	7	12
25	7	12

Shaft shown in full CCW position

### Note

Marked are specifications recommended by Alps Alpine.

# 9mm Size Metal Shaft Snap-in Type / Attached Parts

The following parts are included with the product.

Unit:mm

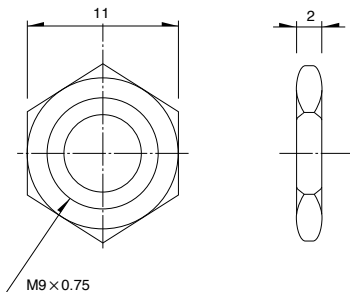
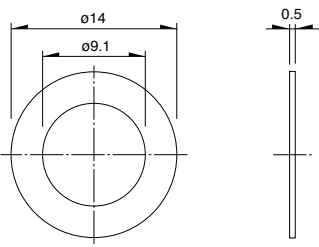
Nut	Washer
	

# 9mm Size Metal Shaft Snap-in Type / Ordering Products Not Listed

When ordering product varieties that are not listed, specify referring to the examples below.

## Sample Part Number

**R K 0 9 L 1 1 4 0** — **F 1 5** — **C 0** — **B 1 0 3**

Model type

Code	Model type
112	Single-unit horizontal type
114	Single-unit vertical type
122	Dual-unit horizontal type for tone
124	Dual-unit vertical type for tone
12B	Dual-unit horizontal type for vol.
12D	Dual-unit vertical type for vol.

Shaft type

Code	Shaft type
F	Flat

\* Only available in flat format.

Length of the shaft L<sub>1</sub> (mm)

Code	Length of the shaft	Code	Length of the shaft	Code	Length of the shaft
12	12.5	17	17.5	25	25
15	15	20	20	—	—

Detent

Code	Center detent
C0	Without
C1	With

Resistance taper

Code	Resistance taper	Code	Resistance taper
A	15A	V	3B
B	1B	C	15C

B: For tone & general (model type : 112, 114, 122, 124)

V: For vol. (model type : 112, 114, 12B, 12D)

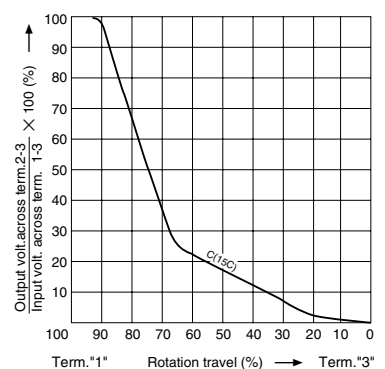
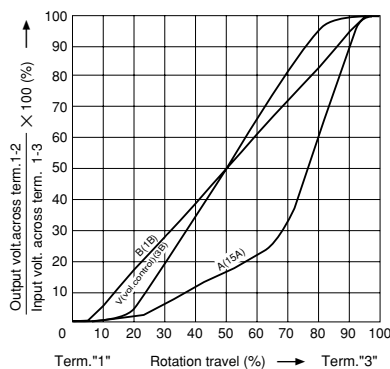

Total resistance











Code	Total resistance (kΩ)	記号	全抵抗値(kΩ)
502	5	503	50
103	10	104	100
203	20	—	—

### Note

Marked are specifications recommended by Alps Alpine.

# Metal Shaft Potentiometers

## List of Varieties

Type	9mm size				11mm size
Series	RK09L		RK0971	RK0972	RK119
	Single-shaft			Dual-shaft	Single-shaft
Number of resistor elements	Single/dual			Dual	Single
Photo					
Terminal mounting	Horizontal	Vertical	Horizontal		Vertical
Fixing method of bushing	Screw				Guide
Operating temperature range	-10°C to +70°C		-20°C to +70°C -40°C to +85°C (Vehicle-compatible)		-40°C to +85°C
Operating life	15,000 cycles				
Available for automotive use	—	—	○	○	○
Life cycle (availability)					
Electrical performance	Total resistance (kΩ)	10, 20, 50, 100			10
	Resistance taper	15A, 1B, 3B, 15C			1B
	Rated Power	0.05W			
	Residual resistance	$R \leq 10k\Omega$ 20Ω max. $10k\Omega < R < 50k\Omega$ 30Ω max. $50k\Omega \leq R$ Nominal total resistance of 0.1% or less			$R \leq 10k\Omega$ 50Ω max.
	Maximum attenuation (Volume control)	$5k\Omega \leq R < 10k\Omega$ 70dB min. $10k\Omega \leq R < 50k\Omega$ 80dB min. $50k\Omega \leq R$ 90dB min.	$5k\Omega \leq R < 10k\Omega$ 70dB min. $10k\Omega \leq R < 50k\Omega$ 80dB min. $50k\Omega \leq R < 100k\Omega$ 90dB min. $100k\Omega \leq R$ 100dB min.		—
	Gang error applicable to Dual-unit parts for audio volume control purposes	-40dB to 0dB 3dB max.			—
	Insulation resistance	100MΩ min. 250V DC			
	Voltage proof	300V AC for 1minute			300V AC for 1 minute or 360V for 2s
	Center-taps	Without	Without / With		Without
Mechanical performance	Detent	Without, Center			Without
	Stopper strength	0.5N·m	0.5N·m (With push-lock mechanism: 0.4N·m)		0.5N·m
	Push-pull strength	80N max.	100N max.		
	Vibration	10 to 55 to 10Hz/min., the amplitude is 1.5mm for all the frequencies, in the 3 direction of X, Y and Z and for 2 hours respectively			
Shaft style	Flat type			Inner-shaft: flat type Outer-shaft: slotted type	Flat type
Terminal style	Insertion				Reflow
Attached switch	—	—	Rotary switch Push-on push-off switch Push-on switch Push-lock switch	—	Push-on switch
Page	306		310		321

Metal Shaft Potentiometers Soldering Conditions	343
Potentiometers Cautions	418
Potentiometers Measurement and Test Methods	420
Potentiometers Resistance Taper	422

### Notes

- For the switch attached, the single-shaft or inner shaft of the dual-shaft type can be chosen.
- The operating temperature range for automotive applications can be raised upon request. Please contact us for details.
- Indicates applicability to some products in the series.

## Reference for Manual Soldering

Series	Tip temperature	Soldering time	No. of solders
<b>RK09L, RK097</b>	350°C max.	3s max.	1 time
<b>RK203</b>	300°C max.	3s max.	1 time
<b>RK119</b>	350±10°C	3 <sup>+1</sup> <sub>0</sub> s	1 time
<b>RK271</b>	350°C max.	5s max.	1 time
<b>RK501</b>	350±10°C	5 <sup>+1</sup> <sub>0</sub> s	1 time
<b>RK163</b>	350°C max.	5s max.	1 time
<b>RK168</b>	<b>Potentiometer terminal</b>	300°C max.	3s max.
	<b>Motor terminal</b>	350°C max.	2s max.

## Reference for Dip Soldering

Series	Preheating		Dip soldering		No. of solders
	Soldering surface temperature	Heating time	Soldering temperature	Soldering time	
<b>RK09L, RK097, RK203</b>	100°C max.	2 min. max.	260±5°C	5±1s	2 time max.
<b>RK501</b>	120±10°C	2 min. max.	260±5°C	5±1s	2 time

## Example of Reflow Soldering Condition

Temperature profile

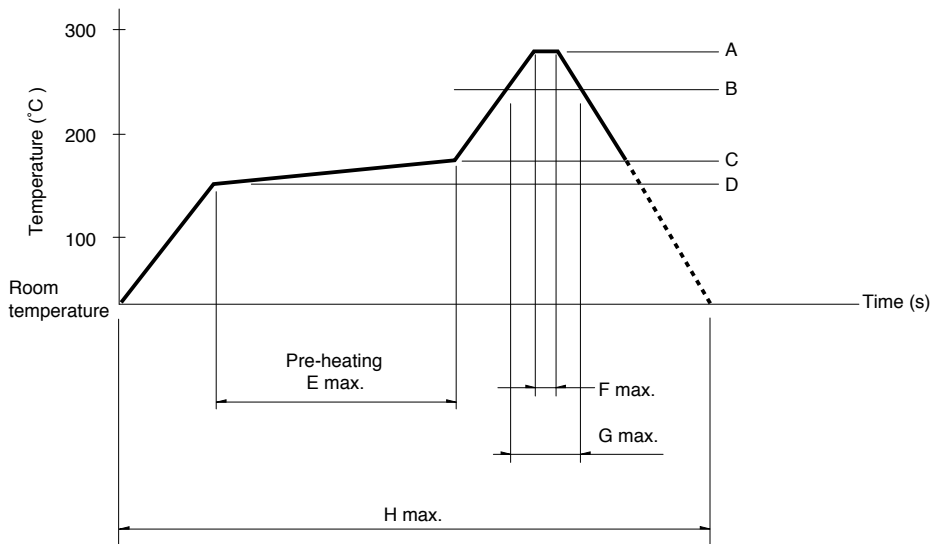

Series	A	B	C	D	E	F	G	H	No. of reflows
<b>RK119</b>	260°C	230°C	180°C	150°C	2 min.	3s	40s	4 min.	2 time max.

### Notes

1. When using an infrared reflow oven, solder may sometimes not be applied. Be sure to use a hot air reflow oven or at type that uses infrared rays in combination with hot air.
2. The temperatures given above are the maximum temperatures at the terminals of the potentiometer when employing a hot air reflow method. The temperature of the PC board and the surface temperature of the potentiometer may vary greatly depending on the PC board material, its size and thickness. Ensure that the surface temperature of the potentiometer does not rise to 250°C or greater.
3. Conditions vary to some extent depending on the type of reflow bath used. Be sure to give due consideration to this prior to use.