

# 9mm Size Metal Shaft Multi-ganged Potentiometer

RK097/RK098 Series

9.5mm wide, ideal for various car audio equipment controls.

Rotary Potentiometers

Slide Potentiometers

Trimmer Potentiometers

Multi Control Devices

Position Sensors

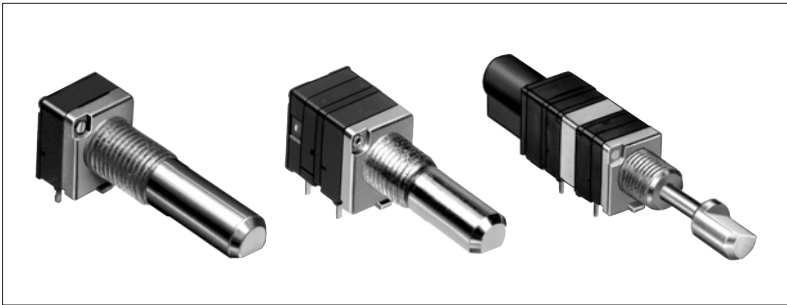

Car Use

Metal Shaft

Insulated Shaft

Knob Operating

## Features

- Insert molding of a resistor prevents flux build-up.

## Applications

- Volume, tone and balance controls for DVD, car audio, home audio, etc.
- Controls for seat heaters, dimmers and wipers in vehicle cabins
- Level controls for communication devices, including transceivers and industrial wireless radios
- Controls for home appliances

## Typical Specifications

Items	Specifications
Total resistance tolerance	±20%
Maximum operating voltage	50V AC
Total rotational angle	300±5°(For shaft movable type, 300 <sup>+10°</sup> <sub>-5°</sub> )
Rotational torque	2 to 25 mN·m
Operating life	15,000 cycles
Operating temperature range	-10°C to +70°C

## Recommended Products List

### Single-shaft without switch type

Number of resistor elements	Mounting direction	Products No.	Shaft type	Length of the shaft (mm)	Center detent	Total resistance (kΩ)	Resistance taper	Minimum packing unit (pcs.)	Drawing No.	
Single-unit	Horizontal type	RK097111080J	Flat	15	Without	10	15A	100	1	
		RK0971110909				20	1B			
		RK097111050B				50	15A			
		RK0971110D7Z			With		1B			
		RK097111020N								
		RK09711100WY			Without	100	15A			
		RK097111080R		20		With				10
		RK0971110D88			50		1B			
		RK09711100F8								Without
		RK09711100Q2				10				
		RK097111091M			1B					
		RK0971110D57				25	Without			10
			1B							

## Note

Additional product specifications in response to those not included in the above recommended products are also available.

For Product Specifications, see P.19, 20

**Recommended Products List**  
Single-shaft without switch type

Number of resistor elements	Mounting direction	Products No.	Shaft type	Length of the shaft (mm)	Center detent	Total resistance (kΩ)	Resistance taper	Minimum packing unit (pcs.)	Drawing No.
Dual-unit for tone	Horizontal type	RK0971210D97	Flat	20	With	100	1B	100	2
		RK0971210096		25		10	15A		
		RK097121009J					100		
		RK097121009K				15			
RK09712200MC		Without			3B		15A		
RK09712200MY				20			50		
RK09712200HA		15A							
RK097122008T		3B							
RK09712200FS	15A								
Dual-unit for vol.									

Single-shaft with rotary switch type

Number of resistor elements	Mounting direction	Products No.	Shaft type	Length of the shaft (mm)	Center detent	Total resistance (kΩ)	Resistance taper	Minimum packing unit (pcs.)	Drawing No.
Single-unit	Horizontal type	RK0971111Z0P	Flat	15	Without	20	15A	100	3
		RK09711110A0				100			
		RK09711110AL		20		10	1B		
		RK09711110EL					15		
RK0971221Z05		20		50		3B			4
RK097122100Y									

Single-shaft push-on push-off switch type

Number of resistor elements	Mounting direction	Products No.	Shaft type	Length of the shaft (mm)	Center detent	Total resistance (kΩ)	Resistance taper	Minimum packing unit (pcs.)	Drawing No.
Single-unit	Horizontal type	RK097111201V	Flat	20	Without	10	15A	100	5
		RK097111202P		25			1B		
RK097111202Q		15					15A		
RK097121200C				20			50		3B
RK097122200G									

Single-shaft momentary push (0.5mm travel) switch type

Number of resistor elements	Mounting direction	Products No.	Shaft type	Length of the shaft (mm)	Center detent	Total resistance (kΩ)	Resistance taper	Minimum packing unit (pcs.)	Drawing No.
Single-unit	Horizontal type	RK0971114D0B	Flat	15	With	10	3B	100	7
Dual-unit for tone		RK0971214Z06		20	Without		1B		8
Dual-unit for vol.		RK0971224Z01					15A		

**Note**

Additional product specifications in response to those not included in the above recommended products are also available.

For switch specification, see P.21  
For Product Specifications, see P.19, 20

**Recommended Products List**

**Single-shaft momentary push (1.5mm travel) switch type**

Number of resistor elements	Mounting direction	Products No.	Shaft type	Length of the shaft (mm)	Center detent	Total resistance (kΩ)	Resistance taper	Minimum packing unit (pcs.)	Drawing No.
Single-unit	Horizontal type	RK0971114Z07	Flat	20	Without	10	1B	100	9
		RK0971114Z04		25					

**Single-shaft with push-lock mechanism type**

Number of resistor elements	Mounting direction	Products No.	Shaft type	Length of the shaft (mm)	Center detent	Total resistance (kΩ)	Resistance taper	Minimum packing unit (pcs.)	Drawing No.
Single-unit	Horizontal type	RK0971111T065	Flat	25	Without	10	1B	100	10
		RK0971111TZ17				100	15A		
		RK0971111T064			With	10	1B		
		RK0971111TD2M				100			
		RK0971111TD44							
Dual-unit for tone	RK097121TD57	Without	10	15A	11				
Dual-unit for vol.	RK097122T017								
	RK097122T00X		50						

**Single-shaft, dual-unit with push-lock mechanism and pull-lock mechanism type**

	Number of resistor elements	Mounting direction	Products No.	Shaft type	Length of the shaft (mm)	Center detent	Total resistance (kΩ)	Resistance taper	Minimum packing unit (pcs.)	Drawing No.
Specifications for the pull lock section	Dual-unit	Horizontal type	RK098122T02X	Flat	30	With	10	1B	100	12
Specifications for the normal section										

**Dual-shaft, dual-unit without switch type**

	Number of resistor elements	Mounting direction	Products No.	Shaft type	Length of the shaft (mm)	Center detent	Total resistance (kΩ)	Resistance taper	Minimum packing unit (pcs.)	Drawing No.
Specifications for the outer shaft	Dual-unit	Horizontal type	RK097221004K	Slot	10	Without	10	1B	100	13
Specifications for the inner shaft				Flat	20		50			
Specifications for the outer shaft			RK097221005C	Slot	15		10	15A		
Specifications for the inner shaft				Flat	25					
Specifications for the outer shaft			RK097221005H	Slot	15		10	1B		
Specifications for the inner shaft				Flat	25					

**Note**

Additional product specifications in response to those not included in the above recommended products are also available. For inquiries, contact our sales department.

# Product Specifications

In addition to the recommended products, the following specifications can also be accommodated.

## Total Resistance Variety

Total resistance (kΩ)	10	20	50	100
-----------------------	----	----	----	-----

## Resistance Taper

Resistance taper	15A	1B	3B	15C
------------------	-----	----	----	-----

## Note

Can be fitted with centre-taps.

## Single-Shaft Dimension

Flat type

Unit : mm

**Style (Shaft diameter : φ 6)**

Shaft shown in full CCW position.

**Detail dimensions (mm)**

L <sub>1</sub>	L <sub>B</sub>	ℓ
15	5	7
20	7	12 (10)
25	10	12
30	10	12

Models in parenthesis apply to those with a push-on switch and those with a push-on, push-off switch.

---

**Style (Shaft diameter : φ 3.5)**

Shaft shown in full CCW position.

**Detail dimensions (mm)**

L <sub>1</sub>	L <sub>B</sub>	ℓ
15	5	7
20	7	12 (10)
25	10	12
30	10	12

Models in parenthesis apply to those with a push-on switch and those with a push-on, push-off switch.

## Dimension of Dual-Shaft type

**Applications** Both switchless and rotary switch models are available.

**Flat type for inner shaft, slot type for outer shaft**

Unit : mm

**Style (Inner-shaft : φ 6 Outer-shaft : φ 8)**

Shaft shown in full CCW position.

**Detail dimensions (mm)**

L <sub>1</sub>	L <sub>2</sub>	L <sub>B</sub>	ℓ <sub>1</sub>	ℓ <sub>2</sub>
20	10	5	8	4
25	15	7	8	5
30	20	10	8	5
35	25	10	8	5

---

**Style (Inner-shaft : φ 3.5 Outer-shaft : φ 6)**

Shaft shown in full CCW position.

**Detail dimensions (mm)**

L <sub>1</sub>	L <sub>2</sub>	L <sub>B</sub>	ℓ <sub>1</sub>	ℓ <sub>2</sub>
20	10	5	8	4
25	15	7	8	5
30	20	10	8	5
35	25	10	8	5

For resistance taper, see P.23, 226

Rotary Potentiometers  
Slide Potentiometers  
Trimmer Potentiometers  
Multi Control Devices  
Position Sensors

Metal Shaft  
Insulated Shaft  
Knob Operating

# Product Specifications

In addition to the recommended products, the following specifications can also be accommodated.

## Shaft Dimensions of with Push-lock Mechanism

Unit : mm

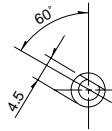
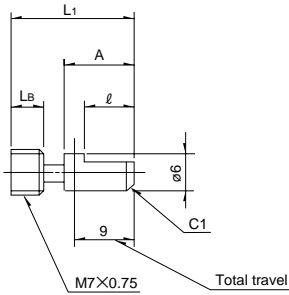

Shaft shown in full CCW position.

### Detail dimensions (mm)

※L <sub>1</sub>	L <sub>B</sub>	A	ℓ
25	10	(5.7)	4.5
30	10	(10.7)	7
35	10	(15.7)	12

※Dimensions when unlock

### Example of uses

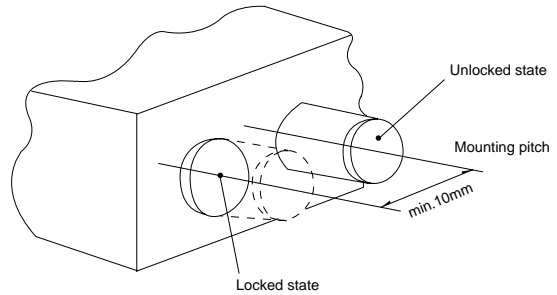
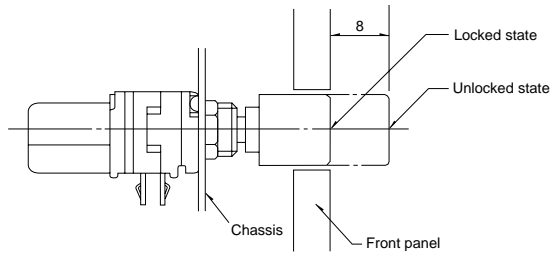

## Shaft Dimensions of with Push-lock Mechanism and with Pull-lock Mechanism

Unit : mm

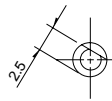
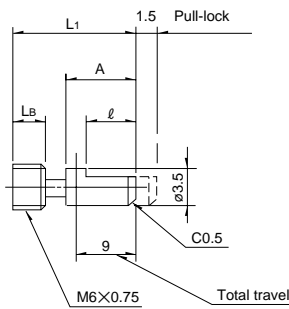

Shaft angle is not specified

### Detail dimensions (mm)

※L <sub>1</sub>	L <sub>B</sub>	A	ℓ
25	10	(5.7)	4.5
30	10	(10.7)	7
35	10	(15.7)	12

※Dimensions when unlock

### Example of uses

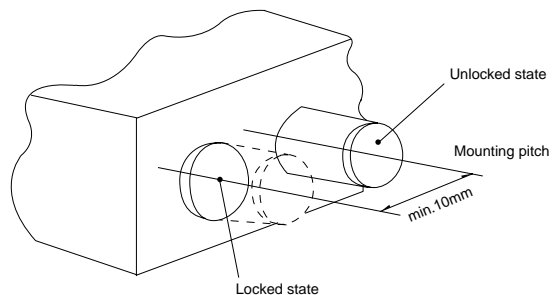
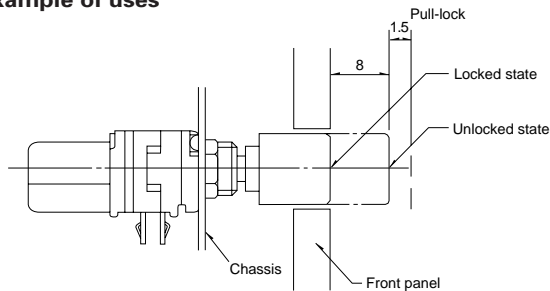

## Specification for Switches

### Mechanical Characteristics

Switch type		Pole-position	Rating	Operating force	Changeover angle (travel)
Rotary switch	5R1211	SPST	3A 16V DC	50mN·m max.	50° max.
	5R1212	SPDT	1A 16V DC		
Push-on Push-off switch	5R2412		DPST	3A 16V DC	12±8N
	5R2421				
Momentary push switch	5R4211	SPST	0.5A 12V DC	4 <sup>+4</sup> <sub>-2</sub> N	0.5mm
	5R4611		0.5A 12V DC	5±2N	1.5mm

Rotary Potentiometers

Slide Potentiometers

Trimmer Potentiometers

Multi Control Devices

Position Sensors

### Electrical Characteristics

Model	Contact resistance		Insulation resistance	Voltage proof
5R1211, 5R1212 5R2412, 5R2421	100mΩ max.	Measured using a 1A 5V DC voltage drop method.	100MΩ min. insulation tester	300V AC 1 minute min.
5R4211, 5R4611		0.5A 5V DC		

Metal Shaft

Insulated Shaft

Knob Operating

### Durability

<b>Operating life under load</b>	The switch under a rated resisted load shall be subjected to a total of 10,000 cycles of operation at a speed of 600 to 1,000 cycles per hour. The contact resistance after testing should not exceed 200mΩ.
----------------------------------	---

### Note

The operating current should be 10mA or greater.

## Configuration Chart

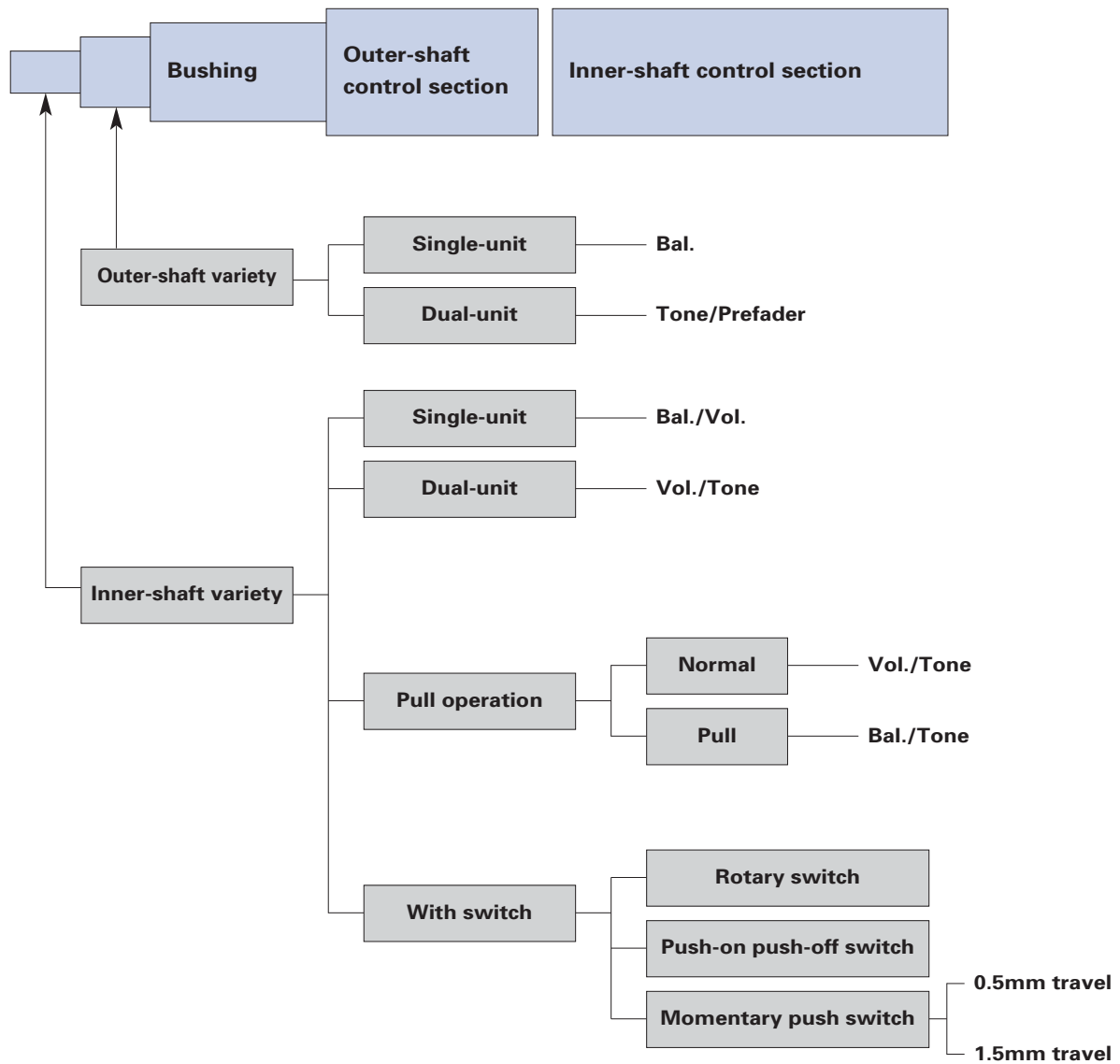

### Note

The single-shaft type product lineups are the same as those in the inner-shaft variety.

# Orders other than recommended products

Specify orders for varieties that are not listed in the Recommended Product List, referring to the following example.

## Sample part number



### Model type

Code	Model type
111	Single-shaft single-unit
121	Single-shaft dual-unit for tone
122	Single-shaft dual-unit for vol.

### Switch specifications

Code	Switch specifications
0	Without switch
1	With rotary switch
4	With momentary push switch(0.5mm travel type)

### Shaft type

Code	Shaft type
F	Flat

### Length of the shaft (L1) (mm)

Code	Length of the shaft	Code	Length of the shaft
15	15	25	25
20	20	30	30

### Detent

Code	Detent	Code	Detent
C0	Without	11	11
C1	Center	31	31

### Resistance taper

Code	Resistance taper	Code	Resistance taper
A	15A	V	3B
B	1B		

\*The resistance law curve on a rotary switch is individually defined.

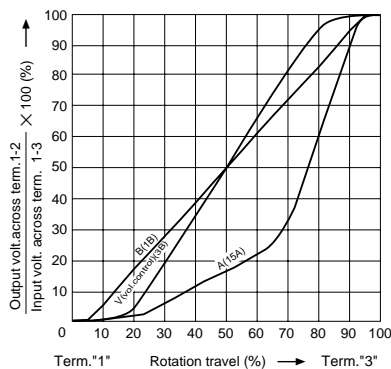

### Total resistance

Code	Total resistance (kΩ)	Code	Total resistance (kΩ)
103	10	503	50
203	20	104	100

## Notes

1.    Shows the specification recommended by us.
2. The above specification is only applicable to the one-shaft single-ganged model and two ganged model.
3. With 1.5mm travel push-on switch model, individual order is necessary.

Rotary Potentiometers

Slide Potentiometers

Trimmer Potentiometers

Multi Control Devices

Position Sensors

Metal Shaft

Insulated Shaft

Knob Operating







Dimensions

Unit : mm

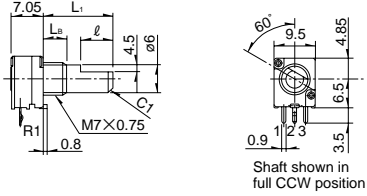
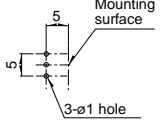
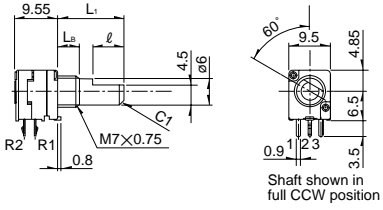
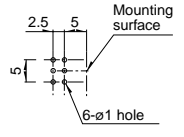
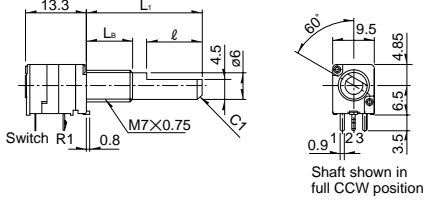
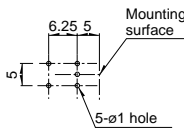
Rotary Potentiometers  
Slide Potentiometers  
Trimmer Potentiometers  
Multi Control Devices  
Position Sensors

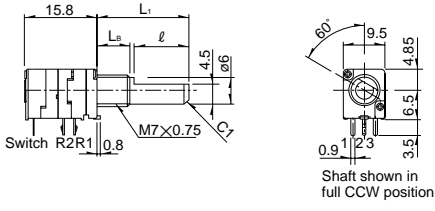
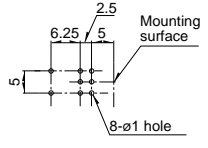
Metal Shaft  
Insulated Shaft  
Knob Operating

No.	Model	Style	PC board mounting hole dimensions (Viewed from mounting side)												
1	Single-shaft, single-unit RK0971110	 <table border="1"> <tr> <td>L<sub>1</sub></td> <td>15</td> <td>20</td> <td>25</td> </tr> <tr> <td>L<sub>B</sub></td> <td>5</td> <td>7</td> <td>10</td> </tr> <tr> <td>l</td> <td>7</td> <td>12</td> <td>12</td> </tr> </table>	L <sub>1</sub>	15	20	25	L <sub>B</sub>	5	7	10	l	7	12	12	
L <sub>1</sub>	15	20	25												
L <sub>B</sub>	5	7	10												
l	7	12	12												
2	Single-shaft, dual-unit RK0971210 (for tone) RK0971220 (for vol.)	 <table border="1"> <tr> <td>L<sub>1</sub></td> <td>15</td> <td>20</td> <td>25</td> </tr> <tr> <td>L<sub>B</sub></td> <td>5</td> <td>7</td> <td>10</td> </tr> <tr> <td>l</td> <td>7</td> <td>12</td> <td>12</td> </tr> </table>	L <sub>1</sub>	15	20	25	L <sub>B</sub>	5	7	10	l	7	12	12	
L <sub>1</sub>	15	20	25												
L <sub>B</sub>	5	7	10												
l	7	12	12												
3	Single-shaft, single-unit with rotary switch RK0971111-5R1211	 <table border="1"> <tr> <td>L<sub>1</sub></td> <td>15</td> <td>20</td> </tr> <tr> <td>L<sub>B</sub></td> <td>5</td> <td>7</td> </tr> <tr> <td>l</td> <td>7</td> <td>12</td> </tr> </table>	L <sub>1</sub>	15	20	L <sub>B</sub>	5	7	l	7	12	 			
L <sub>1</sub>	15	20													
L <sub>B</sub>	5	7													
l	7	12													
4	Single-shaft, dual-unit with rotary switch RK0971221-5R1211 (for vol.)	 <table border="1"> <tr> <td>L<sub>1</sub></td> <td>15</td> <td>20</td> </tr> <tr> <td>L<sub>B</sub></td> <td>5</td> <td>7</td> </tr> <tr> <td>l</td> <td>7</td> <td>12</td> </tr> </table>	L <sub>1</sub>	15	20	L <sub>B</sub>	5	7	l	7	12	 			
L <sub>1</sub>	15	20													
L <sub>B</sub>	5	7													
l	7	12													

Dimensions

Unit : mm

No.	Model	Style	PC board mounting hole dimensions (Viewed from mounting side)									
5	Single-shaft, single-unit with push-on push-off switch RK0971112-5R2412	<table border="1"> <tr> <td>L<sub>1</sub></td> <td>20</td> <td>25</td> </tr> <tr> <td>L<sub>B</sub></td> <td>7</td> <td>10</td> </tr> <tr> <td>l</td> <td>10</td> <td>12</td> </tr> </table>	L <sub>1</sub>	20	25	L <sub>B</sub>	7	10	l	10	12	
L <sub>1</sub>	20	25										
L <sub>B</sub>	7	10										
l	10	12										
6	Single-shaft, dual-unit with push-on push-off switch RK0971212-5R2412 (for tone) RK0971222-5R2412 (for vol.)	<table border="1"> <tr> <td>L<sub>1</sub></td> <td>15</td> <td>20</td> </tr> <tr> <td>L<sub>B</sub></td> <td>5</td> <td>7</td> </tr> <tr> <td>l</td> <td>7</td> <td>10</td> </tr> </table>	L <sub>1</sub>	15	20	L <sub>B</sub>	5	7	l	7	10	
L <sub>1</sub>	15	20										
L <sub>B</sub>	5	7										
l	7	10										
7	Single-shaft, single-unit with momentary push switch travel 0.5mm RK0971114-5R4211											
8	Single-shaft, dual-unit with momentary push switch travel 0.5mm RK0971214-5R4211 (for tone) RK0971224-5R4211 (for vol.)											

Rotary Potentiometers

Slide Potentiometers

Trimmer Potentiometers

Multi Control Devices

Position Sensors





Metal Shaft

Insulated Shaft

Knob Operating

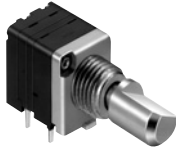
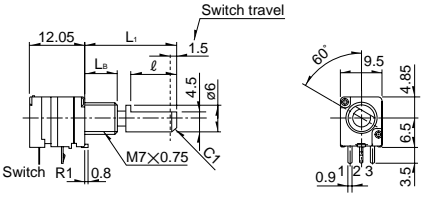
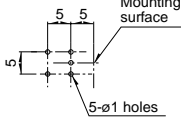
Dimensions

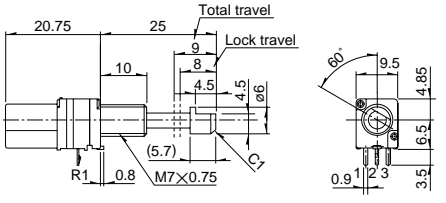
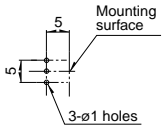
Unit : mm

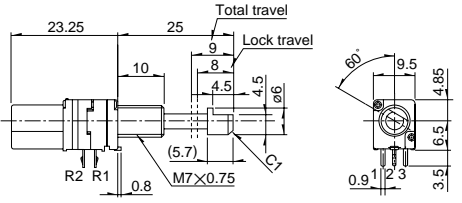
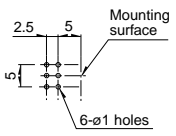
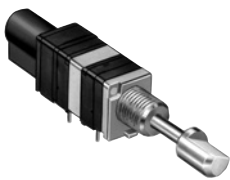
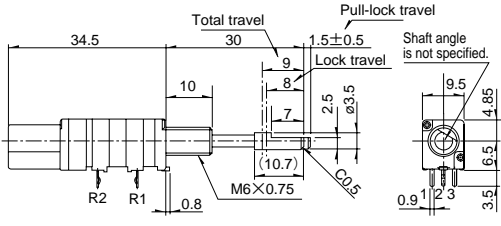
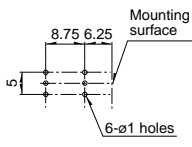
No.	Model	Style	PC board mounting hole dimensions (Viewed from mounting side)									
9	<p>Single-shaft, single-unit with momentary push switch travel 1.5mm RK0971114-5R4611</p> 	 <table border="1" data-bbox="654 660 813 750"> <tr> <td>L<sub>1</sub></td> <td>20</td> <td>25</td> </tr> <tr> <td>L<sub>B</sub></td> <td>7</td> <td>10</td> </tr> <tr> <td>l</td> <td>10</td> <td>12</td> </tr> </table> <p>Shaft shown in full CCW position</p>	L <sub>1</sub>	20	25	L <sub>B</sub>	7	10	l	10	12	
L <sub>1</sub>	20	25										
L <sub>B</sub>	7	10										
l	10	12										
10	<p>Single-shaft, single-unit with push-lock mechanism RK097111T</p> 	 <p>Shaft shown in full CCW position</p>										
11	<p>Single-shaft, dual-unit with push-lock mechanism RK097121T (For tone) RK097122T (For vol.)</p> 	 <p>Shaft shown in full CCW position</p>										
12	<p>Single-shaft, dual-unit with push-lock mechanism and pull-lock mechanism RK098122T</p> 	 <p>Shaft angle is not specified.</p>										

Rotary Potentiometers  
Slide Potentiometers  
Trimmer Potentiometers  
Multi Control Devices  
Position Sensors

Metal Shaft  
Insulated Shaft  
Knob Operating

Dimensions

Unit : mm

No.	Model	Style	PC board mounting hole dimensions (Viewed from mounting side)
13	Dual-shaft, dual-unit RK0972210	<p>Shaft shown in full CCW position</p>	
14	Dual-shaft, dual-unit RK0972210	<p>Shaft shown in full CCW position</p>	

Dimensions of Terminal

Unit : mm

<p>Outline drawing without tap</p>	<p>Outline drawing with tap</p>	<p>※ Mounting height (H): 6.5mm(10mm and 12.5mm also available upon request.)                  ※ For single-unit type with tap is only available with H=6.5mm.                  ※ Tap is on the terminal 3 side only.</p> <p>Detail of 2 terminal belong part</p>
------------------------------------	---------------------------------	---

Dimensions of Bushings

Unit : mm

Bushing	M6	M7	M9
Dimensions			
Applications	For single-shaft only	For single and dual-shaft	For concentric dual-shaft only

## Products Specifications

Items		Model	RK09L	RK097 RK098	RK117	RK16
<b>Operating temperature range</b>		-10°C to +70°C				
<b>Electrical performance</b>	<b>Total resistance tolerance</b>	±20%				
	<b>Rated power</b>	0.05W				
	<b>Maximum operating voltage</b>	50V AC				150V AC
	<b>Residual resistance</b>	$R \leq 10k\Omega$ 20Ω max. $10k\Omega < R \leq 50k\Omega$ 30Ω max. $50k\Omega < R$ Nominal total resistance of 0.1% or less				
	<b>Maximum attenuation (Volume control)</b>	$5k\Omega \leq R < 10k\Omega$ 70dB min. $10k\Omega \leq R < 50k\Omega$ 80dB min. $50k\Omega \leq R < 100k\Omega$ 90dB min. $100k\Omega \leq R$ 100dB min.				
	<b>Insulation resistance</b>	100MΩ min. 250V DC				100MΩ min. 500V DC
	<b>Voltage proof</b>	1 minute 300V AC				1 minute 500V AC
<b>Mechanical performance</b>	<b>Total rotational angle</b>	RK09L $300 \pm 5^\circ$ RK097 $300 \pm 5^\circ$ (Axis movement type is $300 \begin{smallmatrix} +10^\circ \\ -5^\circ \end{smallmatrix}$ ) RK098 $300 \begin{smallmatrix} +10^\circ \\ -5^\circ \end{smallmatrix}$			$300 \begin{smallmatrix} +10^\circ \\ -5^\circ \end{smallmatrix}$	$300 \pm 5^\circ$
	<b>Rotational torque</b>	2 to 25mN·m				
	<b>Stopper strength</b>	0.5N·m (For shaft movable type, 0.4N·m)				0.9N·m (For dual-shaft type, 0.6N·m)
	<b>Push-pull strength</b>	80N max.	100N max.			
	<b>Vibration</b>	10 to 55 to 10Hz / min., the amplitude is 1.5mm for all the frequencies, in the 3 direction of X, Y and Z and for 2 hours respectively				
	<b>Solderability</b>	230±5°C, 3±0.5s				
	<b>Solder heat resistance</b>	<b>Manual soldering</b>	350°C or less and within 3 seconds			
<b>Dip soldering (Dip available products)</b>		260±5°C 4±1s				
<b>Endurance</b>	<b>Operating life</b>	15,000 cycles				
<b>Environmental test</b>	<b>Cold</b>	-10°C for 96h				
	<b>Long-term heat resistance</b>	+70°C for 96h				
	<b>Moisture resistance</b>	+40±2°C, 90 to 95%RH for 96h				

Rotary Potentiometers

Slide Potentiometers

Trimmer Potentiometers

Multi Control Devices

Position Sensors

Metal Shaft

Insulated Shaft

Knob Operating

## Attached Parts

These parts are attached to the following products.

Unit : mm

Applicable products	Bearing screw diameter	Hexagonal nut	Flat washer
<b>RK09L</b> <b>RK168</b> <b>RK097</b>	M9		
<b>RK271</b>	M8		
<b>RK097</b> <b>RK098</b> <b>RK163</b>	M7		
<b>RK097</b> <b>RK098</b>	M6		

Rotary Potentiometers

Slide Potentiometers

Trimmer Potentiometers

Multi Control Devices

Position Sensors

Metal Shaft

Insulated Shaft

Knob Operating