

# Solid State Relays 1-Phase Integrated Heatsink Zero Cross or Instant On Switching Types RGC Solid State Contactor 'U' Connection



- Product width ranging from 17.5 mm up to 70 mm
- Rated operational voltage: up to 660 VAC
- Rated operational current: up to 85 AAC @ 40°C
- Up to 18000 A<sup>2</sup>s for I<sup>2</sup>t and 1200 Vp blocking voltage
- Control voltages: 3-32 VDC, 20-275 VAC (24-190 VDC)
- Design according to EN/IEC60947-4-2, EN/IEC60947-4-3, EN/IEC62314, UL508, CSA 22-2 No. 14-13
- Integrated voltage transient protection with varistor
- 100 kA short circuit current rating according to UL508



## Product Description

This new range of solid state contactors presents a unique opportunity to maximize efficiency in panel space and is an evolution of solid state switches for which Carlo Gavazzi is very well known.

Voltage transient protection is standard across the output with a varistor. Specifications are stated at 25°C unless otherwise noted.

The nominal current ratings are at 40°C. The smallest width is 17.5 mm and is rated at 25 AAC.

1. Germanischer Lloyd approval applicable only to models RGC...15KGU, RGC...20KGU, RGC...25KGU and RGC...30KGU

## Ordering Key **RGC 1 A 60 A 40 K G U**

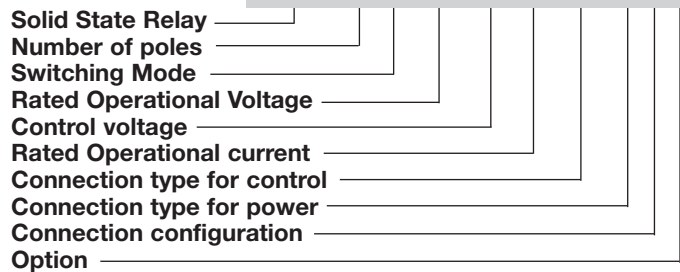

## Ordering Key (Refer to page 2 for available part numbers)

1 Phase SSR with heatsink	Rated voltage, Blocking voltage	Control voltage	Rated current at 40°C <sup>2</sup>	Connection control	Connection power	Connection configuration	Option
<b>RGC1A: ZC<sup>4</sup></b>	23: 230 V +10% - 15%, 800 Vp	D: 3 or 4-32 VDC	15: 20 AAC, 525 A <sup>2</sup> s	K: Screw	G: Box clamp	U: SSR	P: Overtemperature protection (OTP) <sup>3</sup>
<b>RGC1B: IO<sup>4</sup></b>	60: 600 V +10% -15%, 1200 Vp	A: 20 - 275 VAC, 24-190 VDC	20: 23 AAC, 525 A <sup>2</sup> s 25: 25 AAC, 1800 A <sup>2</sup> s 30: 30 AAC, 1800 A <sup>2</sup> s 40: 40 AAC, 3200 A <sup>2</sup> s 42: 43 AAC, 18000 A <sup>2</sup> s 60: 60 AAC, 3200 A <sup>2</sup> s 62: 65 AAC, 18000 A <sup>2</sup> s 90: 85 AAC, 6600 A <sup>2</sup> s	G: Box clamp			X20: Bulk packaging of 20 pcs. <sup>5</sup>

2. Refer to Derating Curves

3. Default control connection for RGC...P is box clamp. See Connections Specifications.

4. ZC = Zero cross switching, IO = Instant On switching

5. Applicable only to RGC..15 and RGC..25 models

## Selection Guide

Rated voltage, Blocking voltage, Switching mode	Control voltage	Connection control/power	Rated operational current @ 40°C (I <sup>2</sup> t value)			
			Product width			
			20 AAC (525 A <sup>2</sup> s) 17.5 mm, low depth	23 AAC (525 A <sup>2</sup> s) 17.5 mm	25 AAC (1800 A <sup>2</sup> s) 17.5 mm, low depth	30 AAC (1800 A <sup>2</sup> s) 22.5 mm
230 V, 800 Vp ZC	3-32 VDC	Screw/Box	RGC1A23D15KGU	RGC1A23D20KGU	RGC1A23D25KGU	RGC1A23D30KGU
	20-275 VAC, 24-190 VDC	Screw/Box	RGC1A23A15KGU	RGC1A23A20KGU	RGC1A23A25KGU	RGC1A23A30KGU
			20 AAC (525 A <sup>2</sup> s) 17.5 mm, low depth	23 AAC (525 A <sup>2</sup> s) 17.5 mm	25 AAC (1800 A <sup>2</sup> s) 17.5 mm, low depth	30 AAC (1800 A <sup>2</sup> s) 22.5 mm
600 V, 1200 Vp ZC	4-32 VDC	Screw/Box	RGC1A60D15KGU	RGC1A60D20KGU	RGC1A60D25KGU	RGC1A60D30KGU
	20-275 VAC, 24-190 VDC	Screw/Box	RGC1A60A15KGU	RGC1A60A20KGU	RGC1A60A25KGU	RGC1A60A30KGU
			40 AAC (3200 A <sup>2</sup> s) 35 mm	43 AAC (18000 A <sup>2</sup> s) 35 mm	60 AAC (3200 A <sup>2</sup> s) 70 mm	65 AAC (18000 A <sup>2</sup> s) 70 mm
	4-32 VDC	Screw/Box	RGC1A60D40KGU	RGC1A60D42KGU	RGC1A60D60KGU	RGC1A60D62KGU
	20-275 VAC, 24-190 VDC	Screw/Box	RGC1A60A40KGU	RGC1A60A42KGU	RGC1A60A60KGU	RGC1A60A62KGU
			20 AAC (525 A <sup>2</sup> s) 17.5 mm, low depth	23 AAC (525 A <sup>2</sup> s) 17.5 mm	25 AAC (1800 A <sup>2</sup> s) 17.5 mm, low depth	30 AAC (1800 A <sup>2</sup> s) 22.5 mm
600 V, 1200 Vp IO	4-32 VDC	Screw/Box	RGC1B60D15KGU	RGC1B60D20KGU	RGC1B60D25KGU	RGC1B60D30KGU
			40 AAC (3200 A <sup>2</sup> s) 35 mm	43 AAC (18000 A <sup>2</sup> s) 35 mm	60 AAC (3200 A <sup>2</sup> s) 70 mm	65 AAC (18000 A <sup>2</sup> s) 70 mm
	4-32 VDC	Screw/Box	RGC1B60D40KGU	RGC1B60D42KGU	RGC1B60D60KGU	RGC1B60D62KGU

## Selection Guide - RGC..P (Integrated Overtemperature Protection)

Rated voltage, Blocking voltage, Switching mode	Control voltage	Connection control/power	Rated operational current @ 40°C (I <sup>2</sup> t value)		
			Product width		
			40 AAC (3200 A <sup>2</sup> s) 35 mm	60 AAC (3200 A <sup>2</sup> s) 70 mm	85 AAC (6600 A <sup>2</sup> s) 70 mm + fan
600 V, 1200 Vp ZC	5-32 VDC	Box/Box	RGC1A60D40GGUP	RGC1A60D60GGUP	RGC1A60D90GGUP
	20-275 VAC, 24-190 VDC	Box/Box	RGC1A60A40GGUP	RGC1A60A60GGUP	RGC1A60A90GGUP
			85 AAC (6600 A <sup>2</sup> s) 70 mm + fan		
600 V, 1200 Vp IO	5-32V DC	Box/Box	RGC1B60D90GGUP		

## Selection Guide - RGC..X20 (RGC bulk packaging of 20 pcs.)

Rated voltage, Blocking voltage, Switching mode	Control voltage	Connection control/power	Rated operational current @ 40°C (I <sup>2</sup> t value)		
			Product width		
			25 AAC (1800 A <sup>2</sup> s) 17.5 mm, low depth		
600 V, 1200 Vp ZC	4-32 VDC	Screw/Box	RGC1A60D25KGUX20		

## Output Voltage Specifications

	RGC..23..	RGC..60..
Operational voltage range	24-240 VAC, +10%, -15% on max	42-600 VAC, +10% -15% on max
Blocking voltage	800 Vp	1200 Vp
Internal varistor	275 V	625 V

## General Specifications

Latching voltage (across L1-T1)	20 V	Rated impulse withstand	6 kV (1.2/50 µs) for voltage, Uimp
Operational frequency range	45 to 65 Hz	Over-voltage category	III (fixed installations)
Power factor	> 0.5 @ Vrated	Isolation	
Touch Protection	IP20	Input to Output RGC...	4000 Vrms
Control input status	continuously ON Green LED, when control input is applied	RGC...D..P	2500 Vrms
Pollution degree	2 (non-conductive pollution with possibilities of condensation)	RGC...A..P	4000 Vrms
		Input and Output RGC...	4000 Vrms
		to case RGC...D..P	4000 Vrms
		RGC...A..P	4000 Vrms
		Input to Fan/Alarm Output RGC...A..P	2500 Vrms

## Output Specifications

	RGC..15..	RGC..20..	RGC..25..	RGC..30..
Rated operational current <sup>7</sup> AC-51 rating @ Ta=25°C	20 AAC	25.5 AAC	30 AAC	30 AAC
AC-51 rating @ Ta=40°C	20 AAC	23 AAC	25 AAC	30 AAC
AC-53a rating @ Ta=40°C	5 AAC	5 AAC	5 AAC	8 AAC
Number of motor starts per hour (x:6, Tx:6s, F:50%) at 40°C <sup>6</sup>	30	30	30	30
Min. operational current	150 mAAC	150 mAAC	250 mAAC	250 mAAC
Rep. overload current - (Motor Rating) PF = 0.4 - 0.5 UL508: T <sub>AMB</sub> =40°C, t <sub>ON</sub> =1s, t <sub>OFF</sub> =9s, 50cycles	51 AAC	60 AAC	51 AAC	84 AAC
Maximum transient surge current (I <sub>TSM</sub> ), t=10ms	325 Ap	325 Ap	600 Ap	600 Ap
Maximum off-state leakage current at rated voltage	3 mAAC	3 mAAC	3 mAAC	3 mAAC
I <sup>2</sup> t for fusing (t=10ms), minimum	525 A <sup>2</sup> s	525 A <sup>2</sup> s	1800 A <sup>2</sup> s	1800 A <sup>2</sup> s
Critical dv/dt (@ T <sub>j</sub> init = 40°C)	1000 V/μs	1000 V/μs	1000 V/μs	1000 V/μs

	RGC..40..	RGC..42..	RGC..60..	RGC..62..	RGC..90..
Rated operational current <sup>7</sup> AC-51 rating @ Ta=25°C	47 AAC	50 AAC	70 AAC	75 AAC	85 AAC
AC-51 rating @ Ta=40°C	40 AAC	43 AAC	60 AAC	65 AAC	85 AAC
AC-53a rating @ Ta=40°C	13 AAC	16 AAC	14.8 AAC	20 AAC	18 AAC
Number of motor starts per hour (x:6, Tx:6s, F:50%) at 40°C <sup>6</sup>	30	30	30	30	30
Min. operational current	400 mAAC	500 mAAC	400 mAAC	500 mAAC	400 mAAC
Rep. overload current - (Motor Rating) PF = 0.4 - 0.5 UL508: T <sub>AMB</sub> =40°C, t <sub>ON</sub> =1s, t <sub>OFF</sub> =9s, 50cycles	126 AAC	126 AAC	126 AAC	168 AAC	168 AAC
Maximum transient surge current (I <sub>TSM</sub> ), t=10ms	800 Ap	1900 Ap	800 Ap	1900 Ap	1150 Ap
Maximum off-state leakage current at rated voltage	3 mAAC	3 mAAC	3 mAAC	3 mAAC	3 mAAC
I <sup>2</sup> t for fusing (t=10ms), minimum	3200 A <sup>2</sup> s	18000 A <sup>2</sup> s	3200 A <sup>2</sup> s	18000 A <sup>2</sup> s	6600 A <sup>2</sup> s
Critical dv/dt (@ T <sub>j</sub> init = 40°C)	1000 V/μs	1000 V/μs	1000 V/μs	1000 V/μs	1000 V/μs

6. Overload profile for AC-53a;

le: AC-53a: x-Tx: F-S, where le = nominal current (AC-53a AAC), x = overload current factor, Tx = duration of overload current (s), F = duty cycle (%), S = number of starts per hour. Example: 5A: AC-53a: 6 - 6 : 50 - 30 = max. 30 starts for the RGC..15 with an overload profile of 30A for 6 seconds with a duty cycle of 50%

7. Refer to Derating Curves

## Overtemperature Alarm Specifications for RGC...P

	RGC..D..P	RGC..A..P
Output type	PNP open collector	Potential Free
Normal state	Closed	Closed
Maximum current rating	50 mADC	50 mADC
Rated voltage (EN61131-2: 2003) <sup>8,9</sup> , U <sub>a</sub>	24 VDC -15%, +20%	24 VDC -15%, +20%
Rated voltage, U <sub>s</sub>	RGC...D90GGUP 24 VDC ± 10%	N/A
Fan rating, U <sub>f</sub>	RGC...A90GGUP N/A	24 VDC ±10%, 50 mA nominal
Alarm voltage drop	Typical Maximum 2.8 VDC 4 VDC	1.8 VDC 3.5 VDC
Visual Indication	Continuous Red LED	Continuous Red LED
Reverse polarity protection	24 VDC	24 VDC

8. DC supply for alarm signal should be supplied from a Class 2 power source

9. Maximum voltage to be applied between 11+ and 12- (U<sub>a</sub>) terminals should be 35VDC maximum with reference to A2-

## Input Specifications

		RGC..D..	RGC..A..
Control voltage range <sup>10, 11</sup>	RGC..23..	3 - 32 VDC	20 - 275 VAC, 24 (-10%) - 190 VDC
	RGC..60..	4 - 32 VDC	20-275 VAC, 24 (-10%) - 190 VDC
	RGC...P (Uc)	5 - 32 VDC	20-275 VAC, 24 (-10%) - 190 VDC
Pick-up voltage	RGC..23..	3.0 VDC	20 VAC/DC
	RGC..60..	3.8 VDC	20 VAC/ 24VDC
	RGC...P	5 VDC	20 VAC/DC
Drop-out voltage		1 VDC	5 VAC/DC
Maximum Reverse voltage		32 VDC	-
Response time pick-up (RGC1A..)		0.5 cycle + 500 μs @ 24 VDC	2 cycles @ 230 VAC/110 VDC
Response time pick-up (RGC1B..)		350 μs @ 24 VDC	N/A
Response time drop-out		0.5 cycle + 500 μs @ 24 VDC	0.5 cycle + 40ms @ 230VAC/ 110VDC
Input current @ 40°C		See diagrams below	See diagrams below

10. DC control to be supplied by class 2 power source according to UL1310

11. For GL approved models control range for RGC1.23... is 4-32VDC and for RGC1.60... 5-32VDC

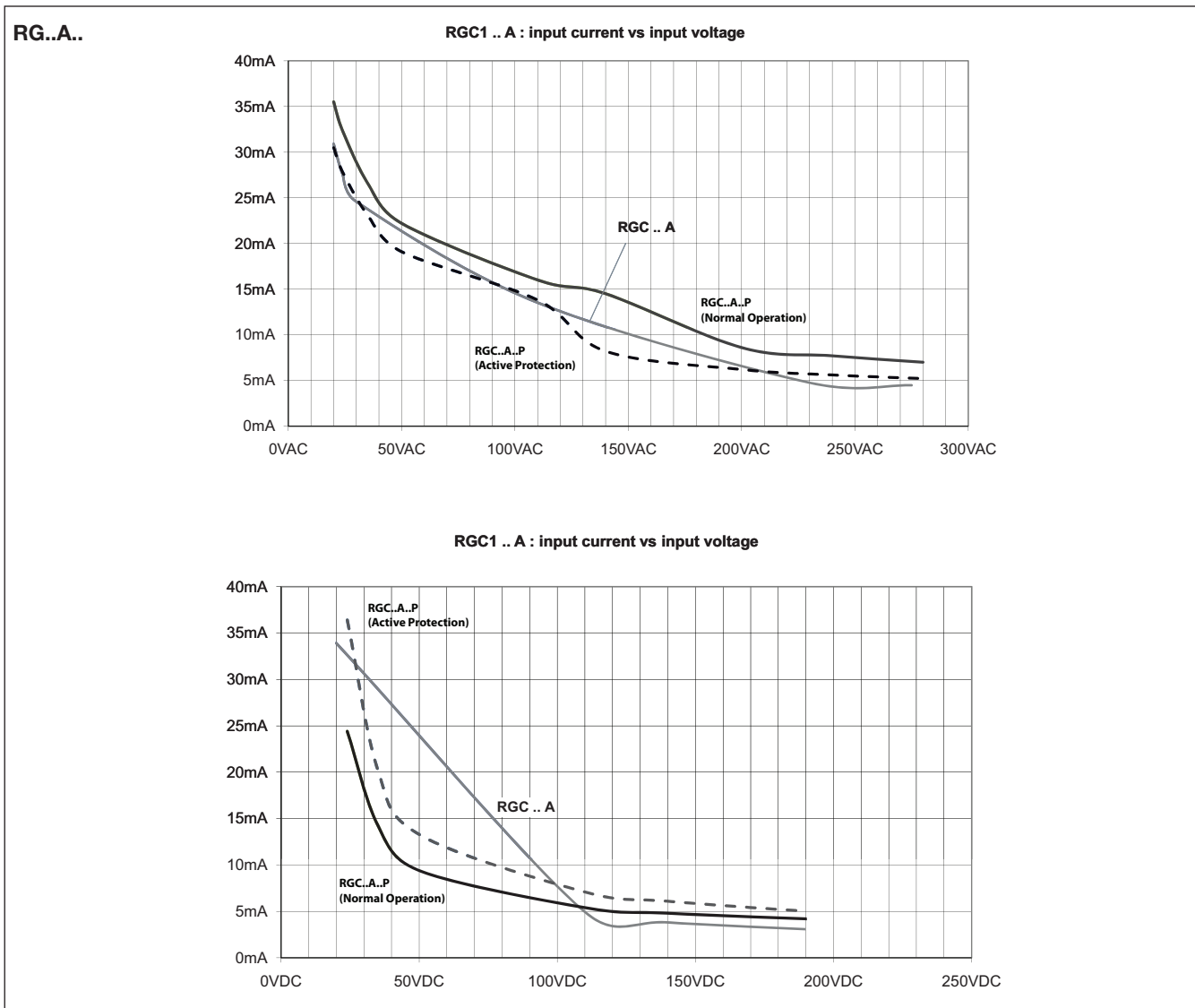

## Input Specifications (cont.)

RG..D..

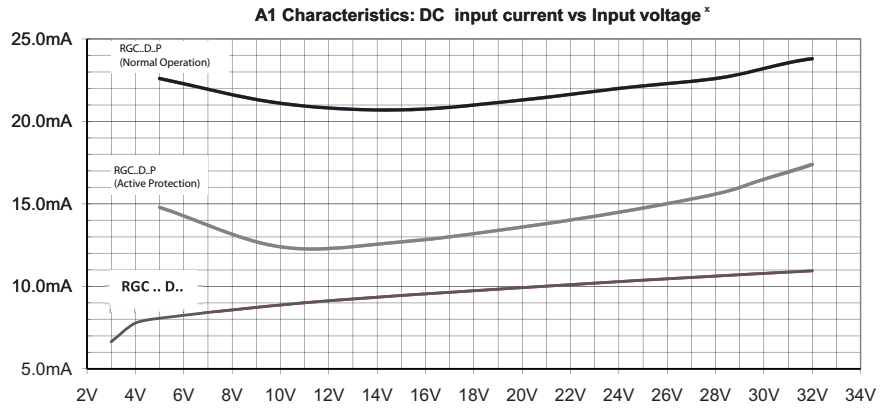

x: Input currents for RGC1..D15, RGC1..D20, RGC1..D25, RGC1..D30, RGC1..D4x, RGC1..D6x

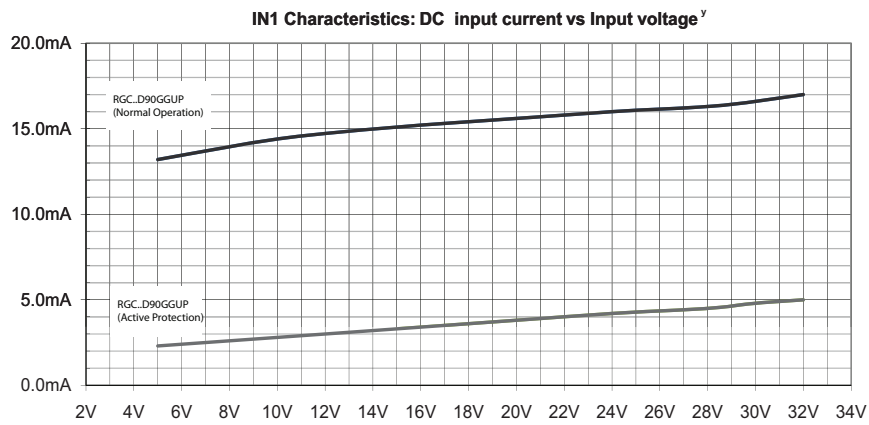

y: input currents valid only for RGC1..D90GGUP

### Motor Ratings: HP (UL508) / kW (EN/IEC60947-4-2) @ 40°C

	115 VAC	230 VAC	400 VAC	480 VAC	600 VAC
RGC..15	1/3 HP / 0.18 kW	1 HP / 0.37 kW	2HP / 0.75kW	3HP / 1.1kW	3HP / 1.5kW
RGC..20	1/2 HP / 0.18 kW	1 1/2 HP / 0.37 kW	2HP / 0.75kW	3HP / 1.1kW	3HP / 1.5kW
RGC..25	1/3 HP / 0.18 kW	1 HP / 0.37 kW	2HP / 0.75kW	3HP / 1.1kW	3HP / 1.5kW
RGC..30	3/4 HP / 0.37 kW	2 HP / 1.1 kW	3HP / 1.5kW	5HP / 2.2kW	5HP / 3.7kW
RGC..40	1 HP / 0.56 kW	3 HP / 1.5 kW	5HP / 2.2kW	5HP / 3.7kW	7 1/2HP / 4kW
RGC..42	1 1/2 HP / 0.56 kW	3 HP / 1.5 kW	5HP / 2.2kW	7 1/2HP / 3.7kW	10HP / 4kW
RGC..60	1 1/2 HP / 0.56 kW	3 HP / 1.5 kW	5HP / 3kW	7 1/2HP / 4kW	10HP / 4kW
RGC..62	2 HP / 0.75 kW	5 HP / 1.5 kW	7 1/2HP / 4kW	10HP / 4kW	15HP / 5.5kW
RGC..90	2 HP / 0.75 kW	5 HP / 1.5 kW	7 1/2HP / 4kW	10HP / 4kW	15HP / 5.5kW

### Detailed Over temperature Alarm Procedure (for RGC...P)

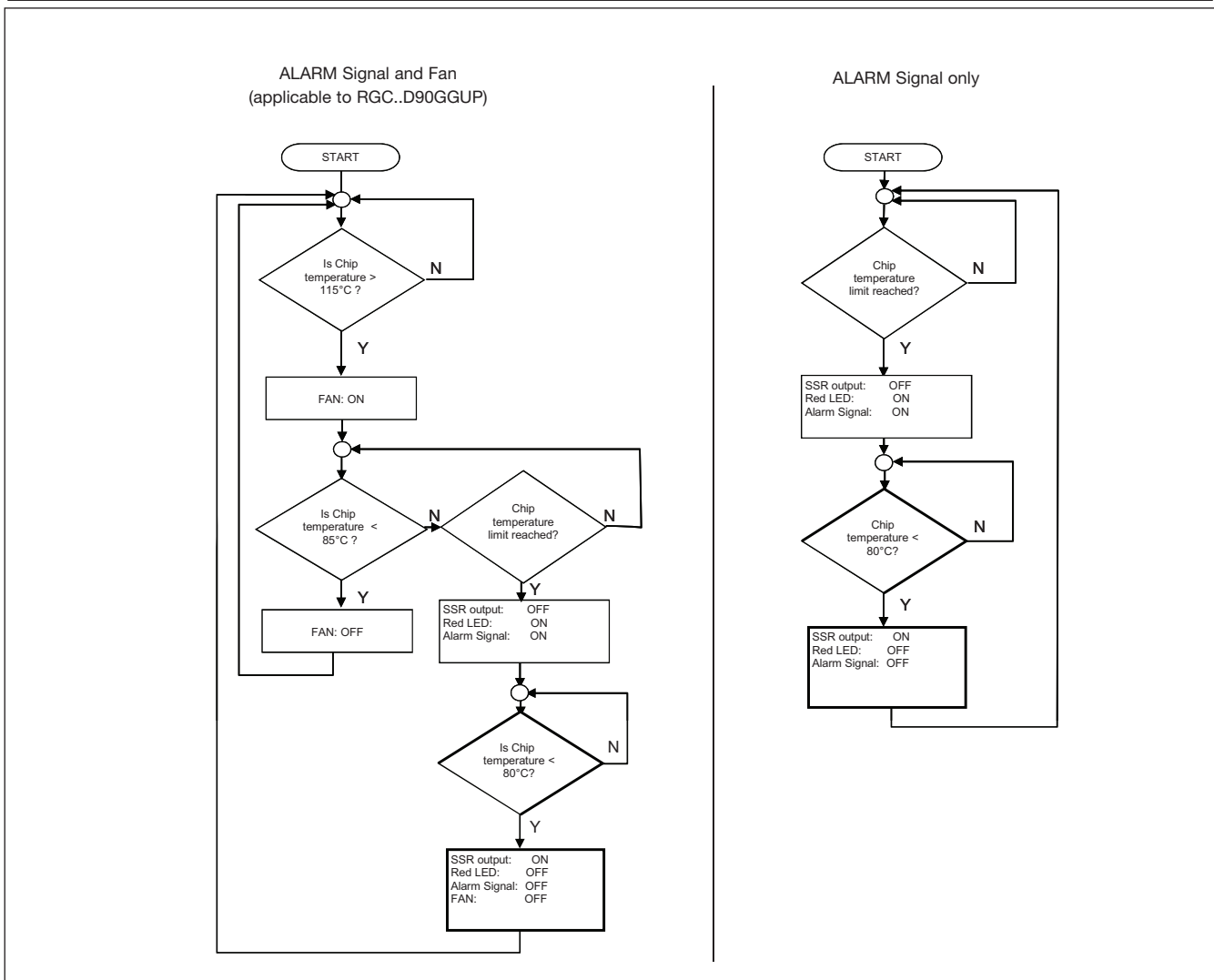

**CAUTION**

- Alarm condition resets whenever the voltage signal is removed from terminal A1 (+)
- In the case of RGC1AD90GGUP, if the voltage signal is not applied across A1(+) and A2 (-) terminals, the overtemperature detection and functionality is lost (including fan operation and alarm signalling)
- In the case of RGC1A60A90GGUP it is necessary to supply IN2 and IN3 with 24VDC for fan operation.
- Alarm procedure for RGC1A60A90GGUP follows 'Alarm signal only' flow since fan is continuously operating.
- Alarm condition automatically resets ONLY when power semiconductor temperature < 80°C
- Temperatures indicated are typical figures.

## Output Power Dissipation

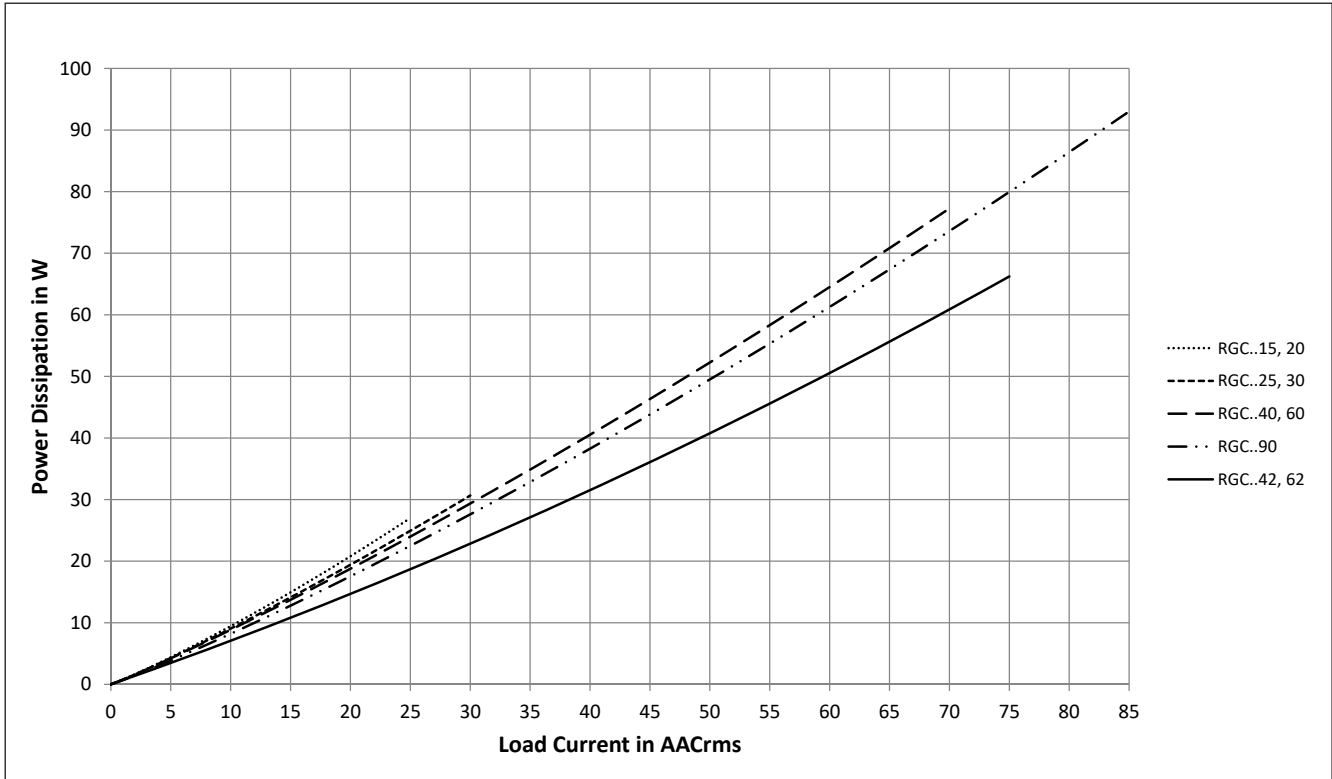

## Current Derating (UL508)

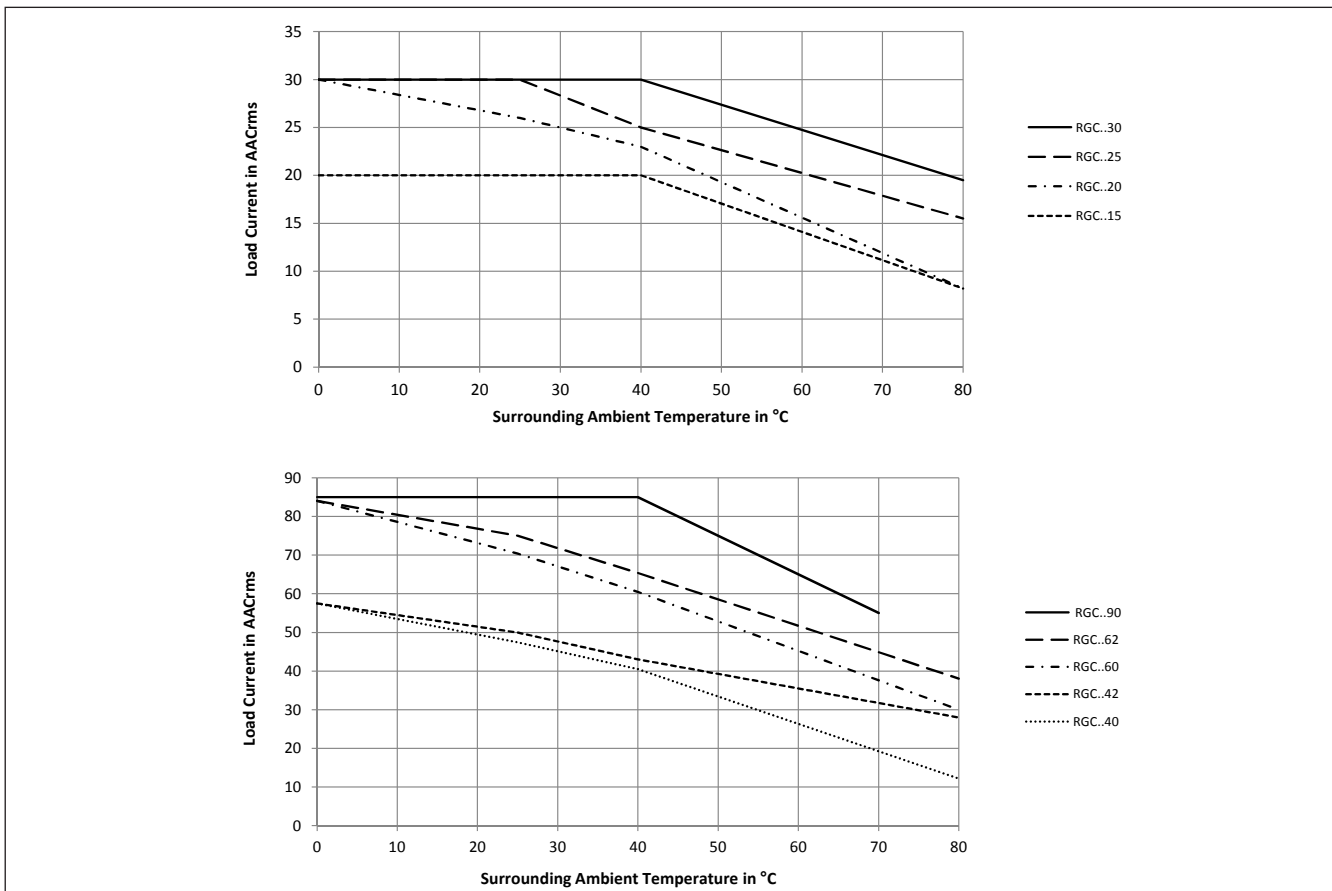

RGC...P models max. operating temperature is + 70°C



## Derating vs. Spacing Curves

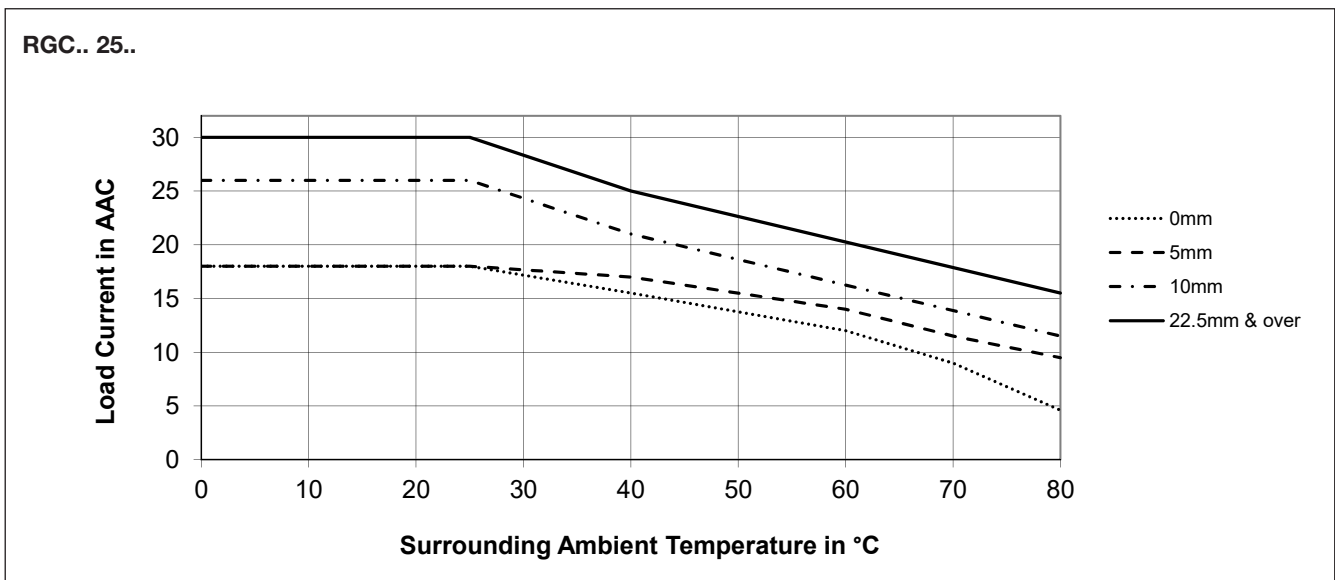
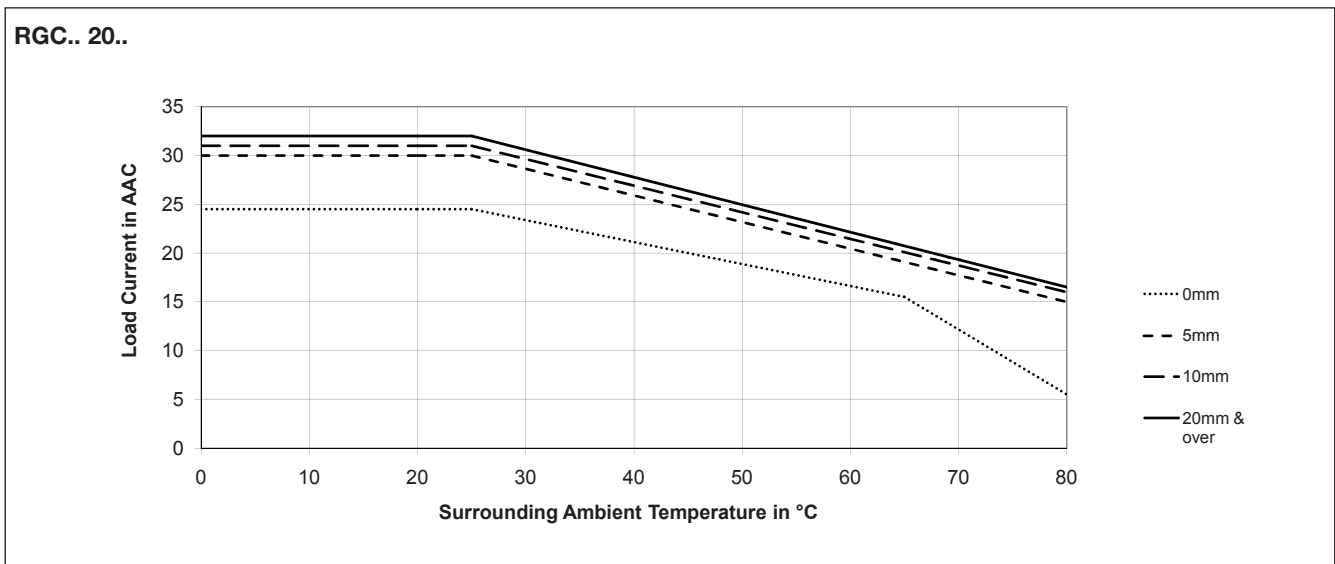
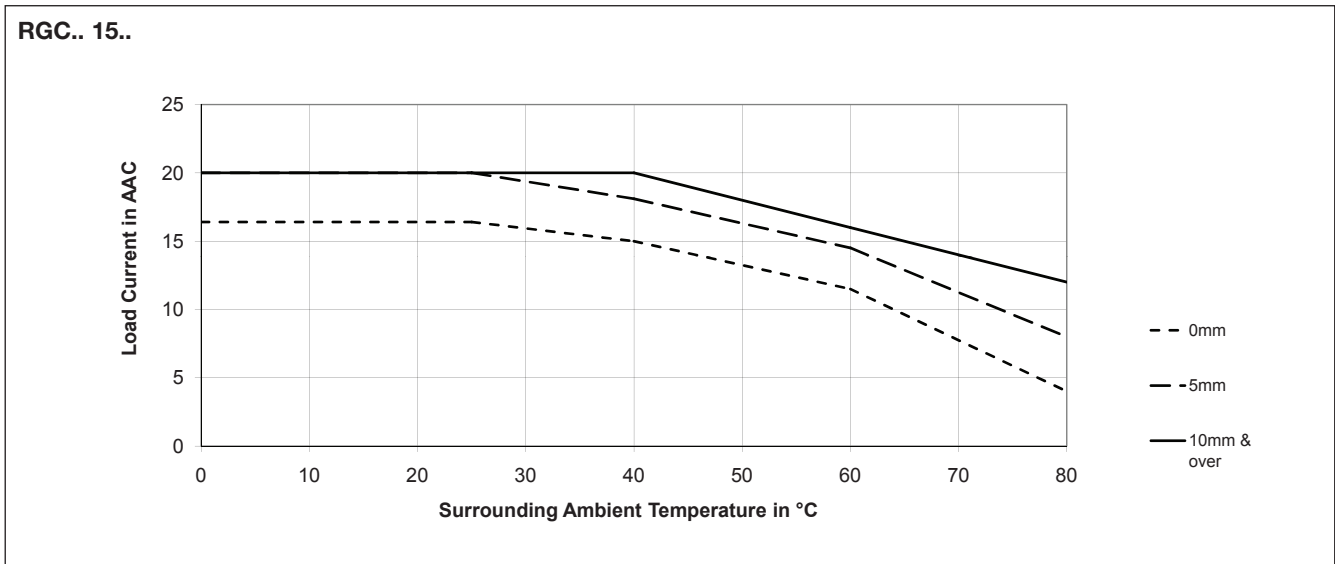

## Derating vs. Spacing Curves (cont.)

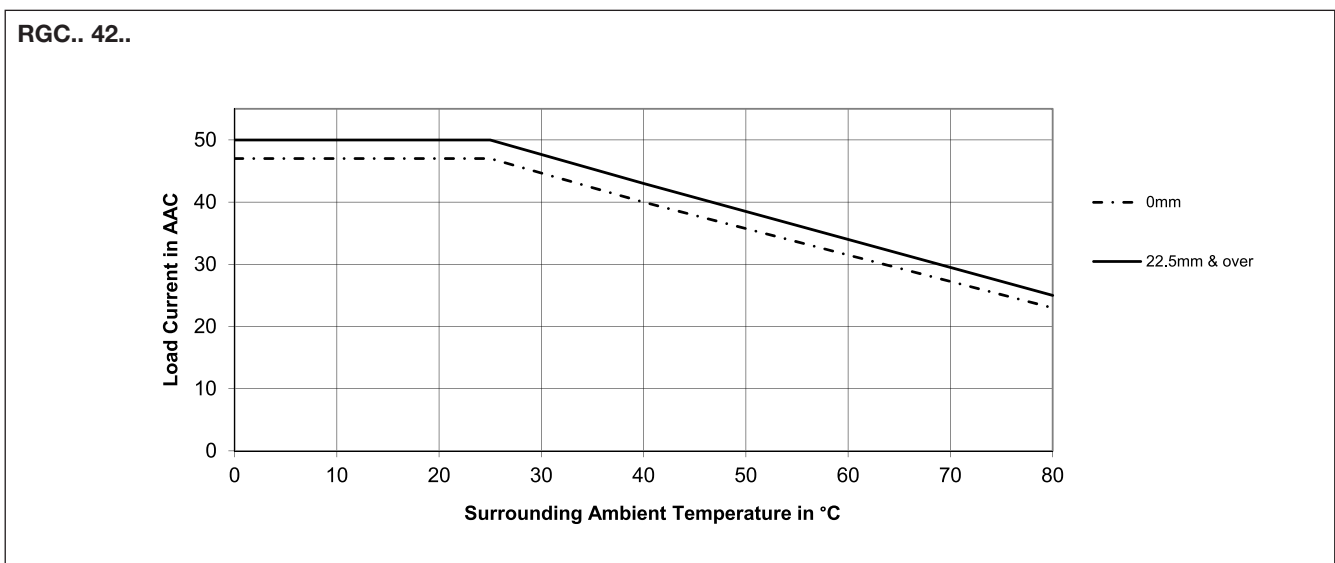
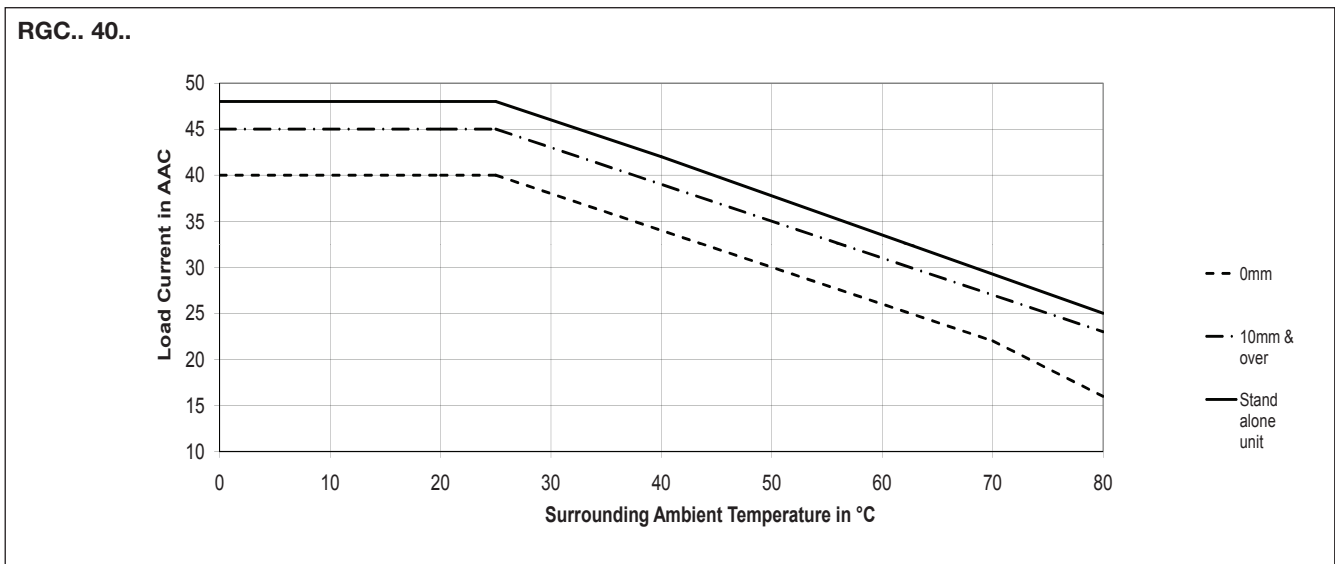
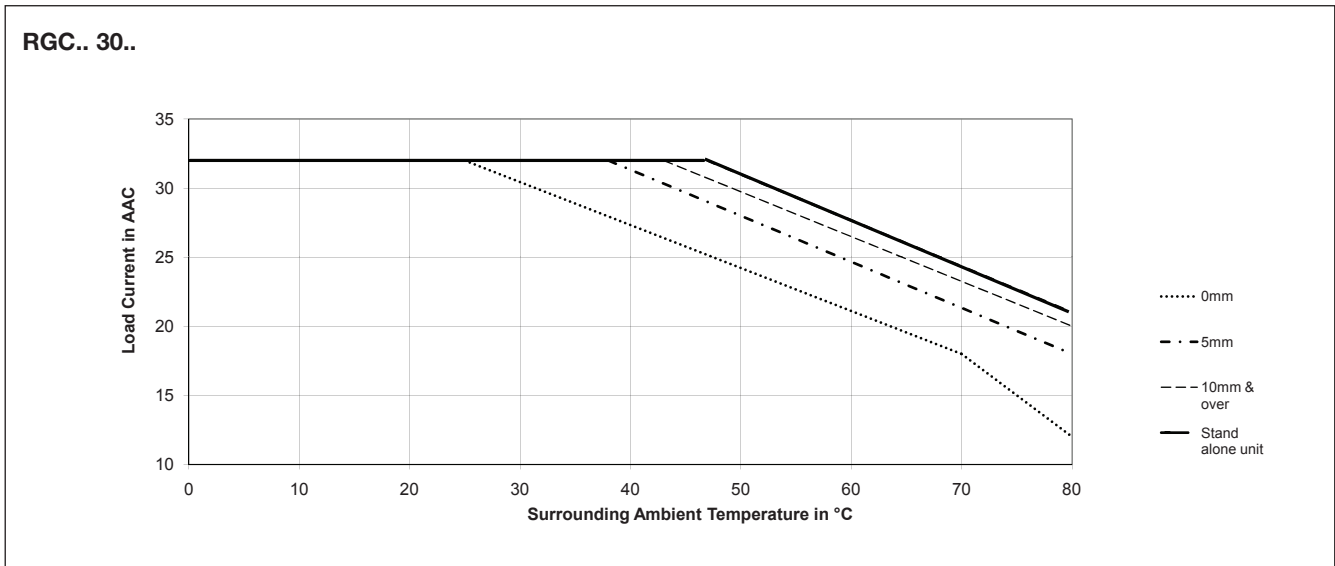

### Derating vs. Spacing Curves (cont.)

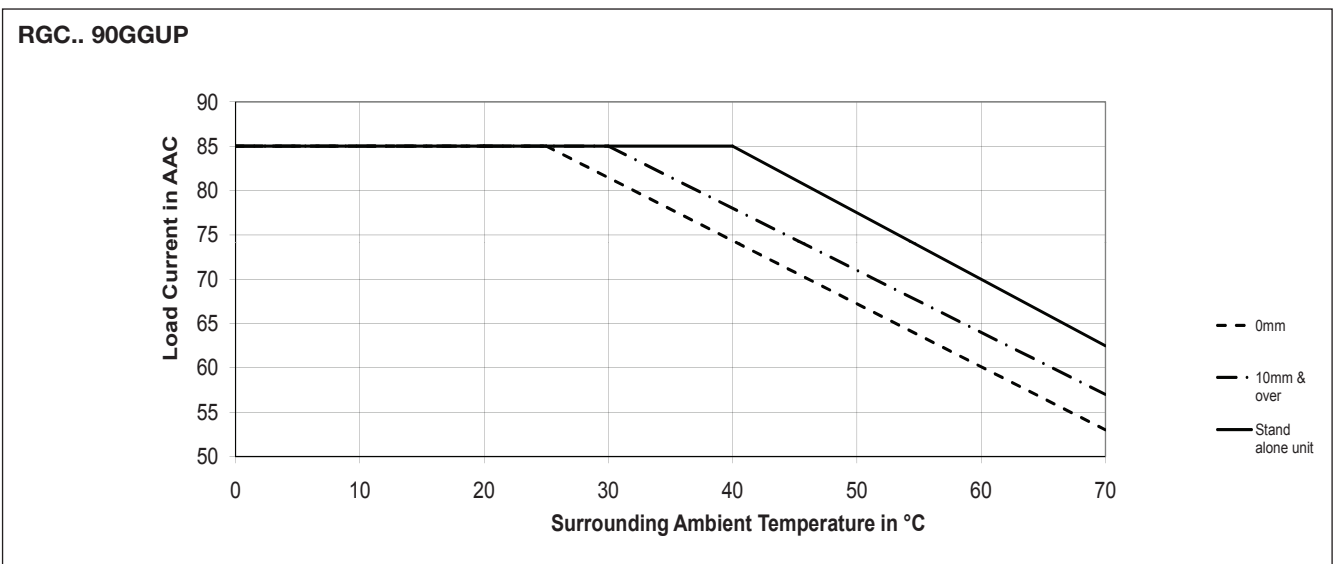
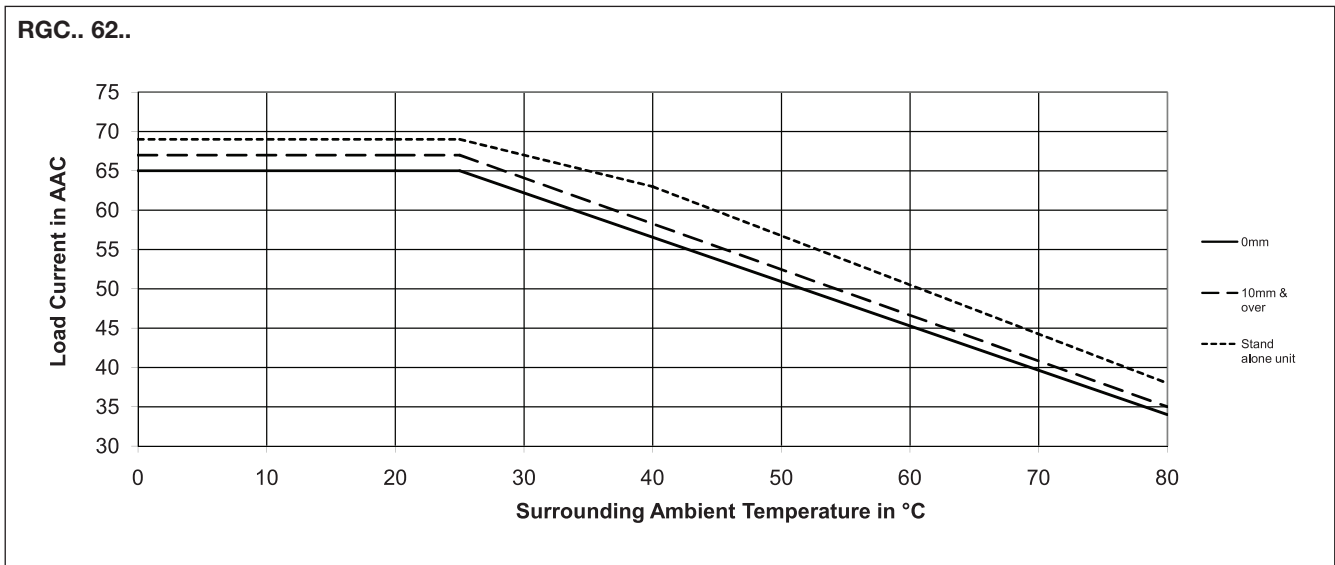
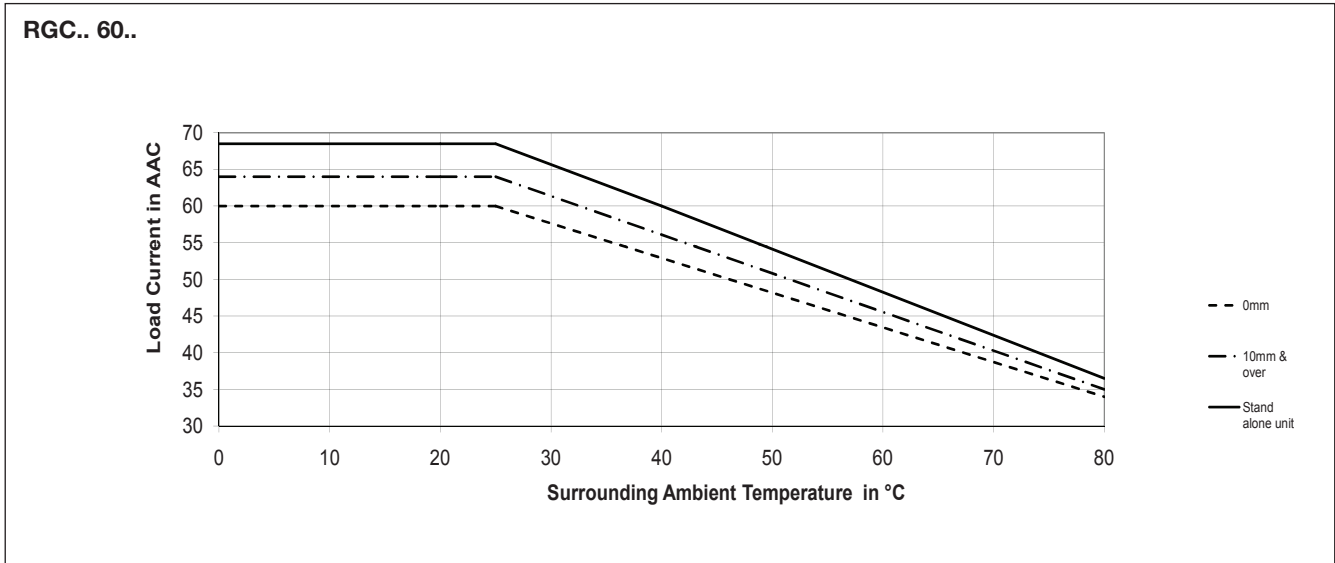

## Agency Approvals and Conformances

<b>Conformance</b>	IEC/EN 62314 IEC/EN 60947-4-2 IEC/EN 60947-4-3	<b>Agency Approvals</b>	UL508 Listed (E172877) cUL Listed (E172877) VDE 0660-109 GL <sup>13</sup>
		<b>Short Circuit Current Rating</b>	100kA, UL508



## Electromagnetic Compatibility

<b>EMC Immunity</b>	EN 60947-4-3	<b>Electrical Surge Immunity (for RGC...UP)</b>	IEC/EN 61000-4-5
<b>Electrostatic Discharge (ESD) Immunity</b>	IEC/EN 61000-4-2	Output, line to line, 1kV	Performance Criteria 1
Air discharge, 8kV	Performance Criteria 1	Output, line to earth, 2kV	Performance Criteria 1
Contact, 4kV	Performance Criteria 1	DC lines, line to line, 500V	Performance Criteria 2
<b>Electrical Fast Transient (Burst) Immunity</b>	IEC/EN 61000-4-4	DC lines, line to earth, 500V	Performance Criteria 2
Output: 2kV, 5kHz	Performance Criteria 1	Signal lines, line to earth, 1kV	Performance Criteria 2
Input: 1kV, 5kHz	Performance Criteria 1	<b>Radiated Radio Frequency Immunity</b>	IEC/EN 61000-4-3
<b>Electrical Surge Immunity (for RGC...U)</b>	IEC/EN 61000-4-5	10V/m, 80 - 1000 MHz	Performance Criteria 1
Output, line to line, 1kV	Performance Criteria 1	10V/m, 1.4 - 2 GHz	Performance Criteria 1
Output, line to earth, 2kV	Performance Criteria 1	3V/m, 2 - 2.7 GHz	Performance Criteria 1
Input, line to line, 1kV	Performance Criteria 2	<b>Conducted Radio Frequency Immunity</b>	IEC/EN 61000-4-6
Input, line to earth, 2kV	Performance Criteria 2	10V/m, 0.15 - 80 MHz	Performance Criteria 1
<b>EMC Emission</b>	EN 60947-4-3	<b>Voltage Dips Immunity</b>	IEC/EN 61000-4-11
<b>Radio Interference</b>		0% for 0.5, 1 cycle	Performance Criteria 2
<b>Voltage Emission (Conducted) 0.15 - 30 MHz</b>	IEC/EN 55011 Class A (industrial) with filters - see filter information	40% for 10 cycles	Performance Criteria 2
		70% for 25 cycles	Performance Criteria 2
		80% for 250 cycles	Performance Criteria 2
		<b>Voltage Interruptions Immunity</b>	IEC/EN 61000-4-11
		0% for 5000ms	Performance Criteria 2
		<b>Radio Interference Field Emission (Radiated) 30 - 1000 MHz</b>	IEC/EN 55011 Class A (industrial)

## Environmental Specifications

Operating Temperature <sup>12</sup>	-40°C to 80°C (-40°F to +176°F)	Relative humidity	95% non-condensing @ 40°C
Storage Temperature	-40°C to 100°C (-40°F to +212°F)	UL flammability rating (housing)	UL 94 V0 Glow wire ignition temperature and Glow wire flammability index conform to EN 60335-1 requirements
EU RoHS compliant	Yes	Installation altitude	0 - 1000m. Above 1000m derate linearly by 1% of FLC per 100m up to maximum of 2000m
China RoHS compliant	Refer to Environmental Information (page 22)		
Impact resistance (EN50155, EN61373)	15/11 g/ms		
Vibration resistance (2-100Hz, IEC60068-2- 6, EN50155, EN61373)	2g per axis		
Weight		RGC..30	approx 375g
RGC..15	approx 260g	RGC..4x (P)	approx 515g (581g)
RGC..20	approx 315g	RGC..6x (P)	approx 972g (1020g)
RGC..25	approx 260g	RGC..90 P	approx 1100g

12. Operating temperature range for RGC..P (overttemperature protection) is -30°C to 70°C (-22°F to 158°F)

13. Applicable to models RGC1...15KGU, RGC1...20KGU, RGC1...25KGU and RGC1...30KGU

## Filtering - EN / IEC 55011 Class A compliance (for class B compliance contact us)

Part Number	Suggested filter for compliance	Maximum Heater current
RGC1A23..15	68 nF / 275 V / X1	20 A
RGC1A23..20	68 nF / 275 V / X1	20 A
RGC1A23..25, RGC1A23..30	220 nF / 275 V / X1	30 A
RGC1A60..15	100 nF / 760 V / X1	20 A
RGC1A60..20	100 nF / 760 V / X1	20 A
RGC1A60..25, RGC1A60..30	220 nF / 760 V / X1	30 A
RGC1A60..40	220 nF / 760 V / X1 330 nF / 760 V / X1	25 A 45 A
RGC1A60..60	220 nF / 760 V / X1 330 nF / 760 V / X1	25 A 45 A
RGC1A60..42, RGC1A...62, RGC1A...90	330 nF / 760 V / X1 680 nF / 760 V / X1	40 A 65 A

Note:

- Control input lines must be installed together to maintain products' susceptibility to Radio Frequency interference.
- Use of AC solid state relays may, according to the application and the load current, cause conducted radio interferences. Use of mains filters may be necessary for cases where the user must meet E.M.C requirements. The capacitor values given inside the filtering specification tables should be taken only as indications, the filter attenuation will depend on the final application.
- Performance Criteria 1: No degradation of performance or loss of function is allowed when the product is operated as intended.
- Performance Criteria 2: During the test, degradation of performance or partial loss of function is allowed. However when the test is complete the product should return operating as intended by itself.
- Performance Criteria 3: Temporary loss of function is allowed, provided the function can be restored by manual operation of the controls.

## Filter Connection Diagrams

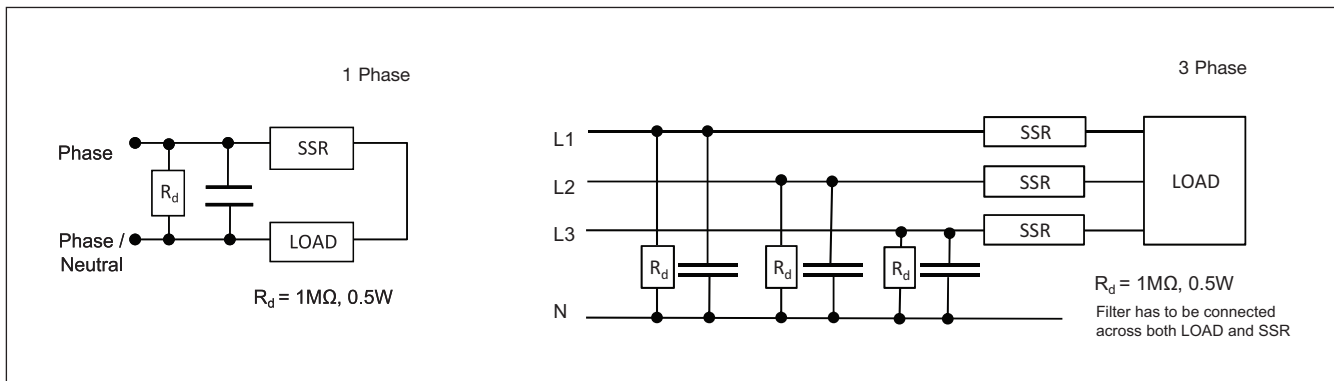

## Connection Diagram (Without OTP)

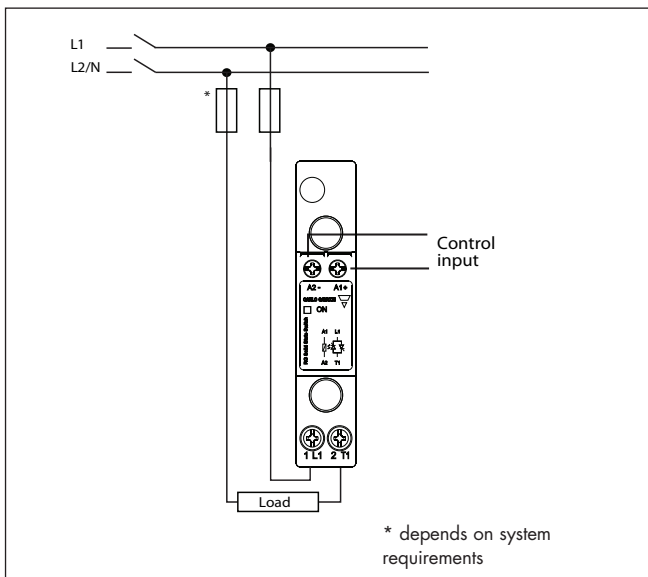

## Functional Diagram (Without OTP)

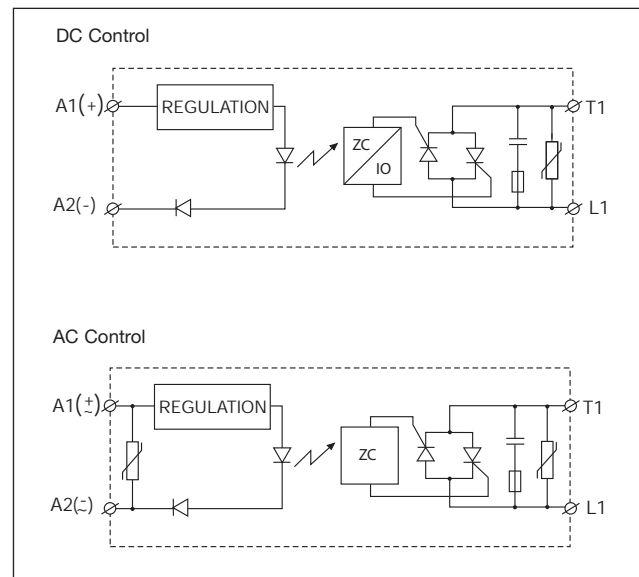

## Connection Diagram (with OTP)

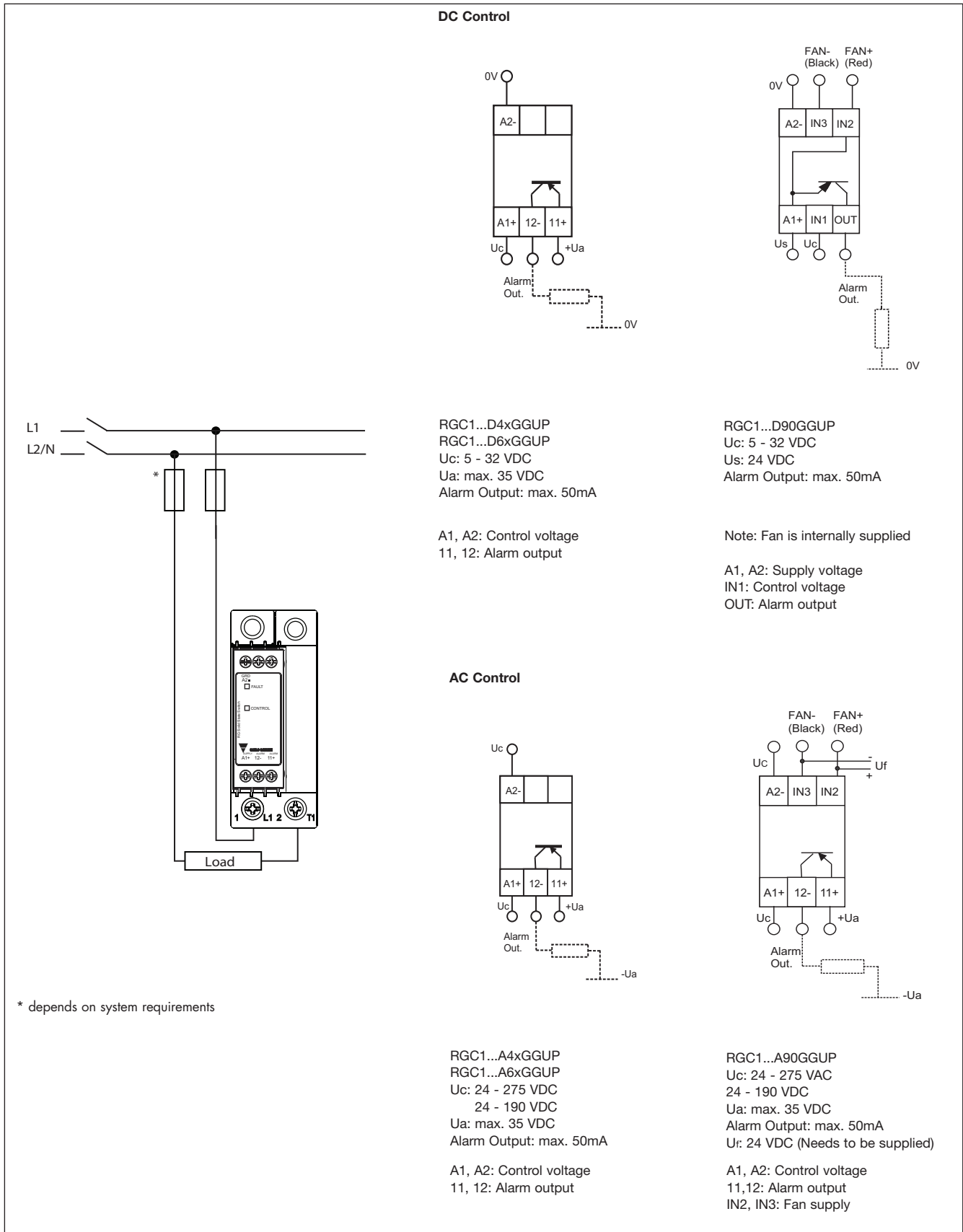

# Terminal Layout and Dimensions

RGC...15KGU, RGC...25KGU

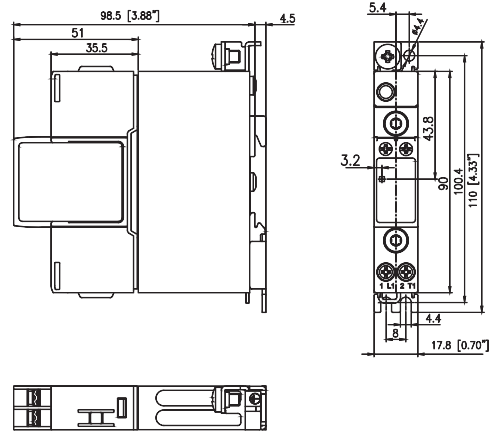
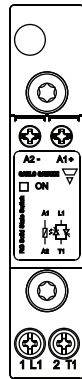

RGC...20KGU

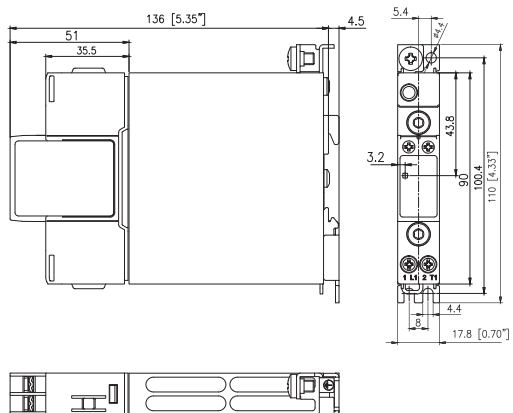
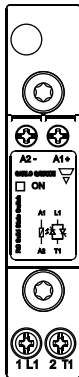

RGC...30KGU

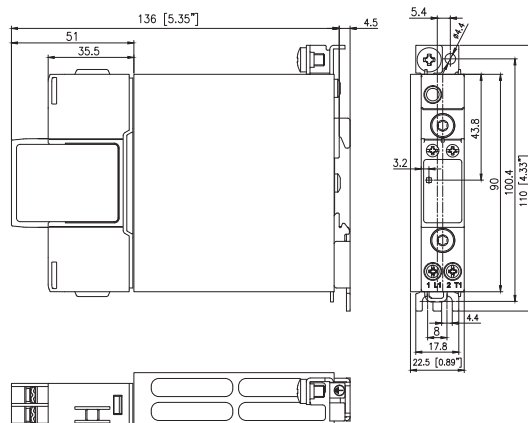
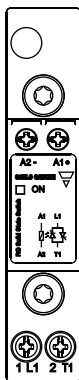

1/L1: Supply connection  
 2/T1: Load connection  
 A1 (+): Positive control signal  
 A2 (-): Control ground

⊕ : Protective earth

Housing width tolerance +0.5mm, -0mm...as per DIN43880.  
 All other tolerances ± 0.5mm. All dimensions in mm.

## Terminal Layout and Dimensions

RGC...40KGU, RGC...42KGU

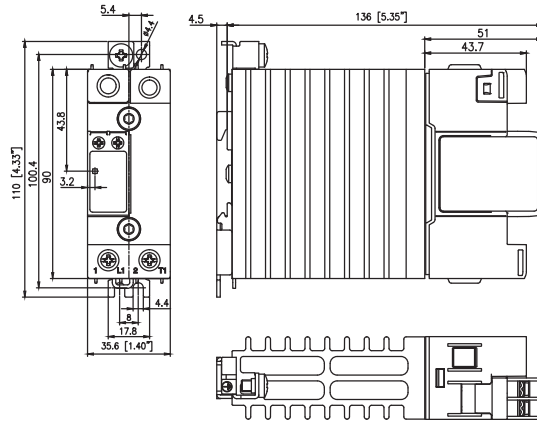
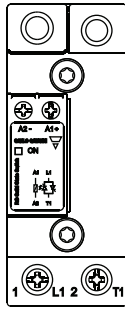

RGC...60KGU, RGC...62KGU

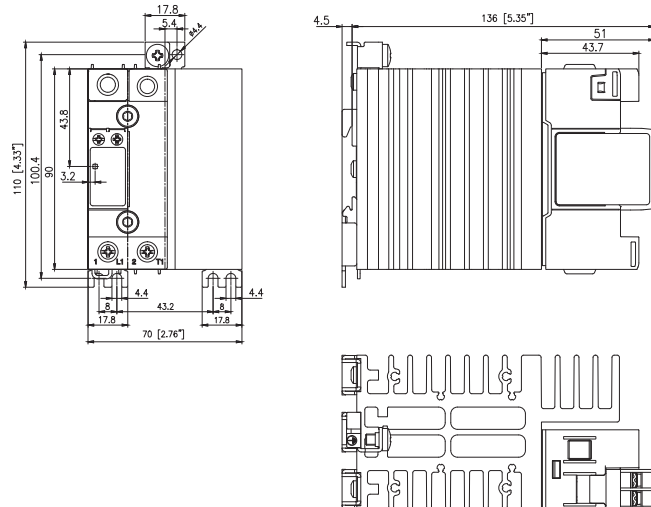
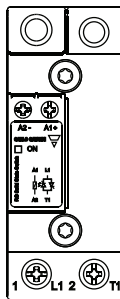

- 1/L1: Supply connection
- 2/T1: Load connection
- A1 (+): Positive control signal
- A2 (-): Control ground

 : Protective earth

Housing width tolerance +0.5mm, -0mm...as per DIN43880.  
All other tolerances ± 0.5mm. All dimensions in mm.



## Terminal Layout and Dimensions (cont.)

### RGC...40GGUP

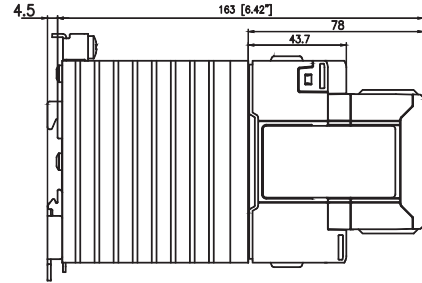
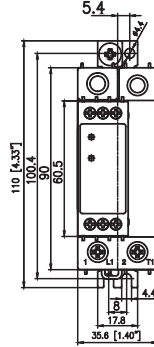
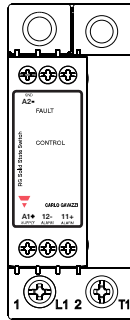

### RGC...60GGUP

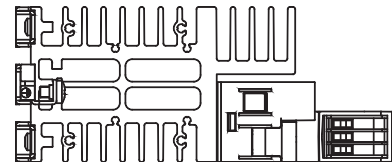
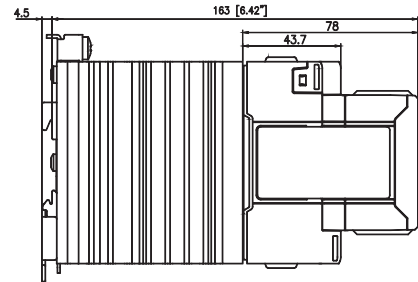
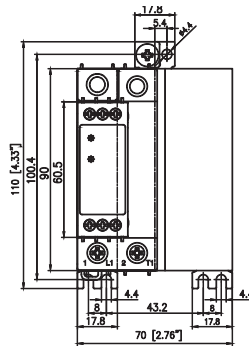
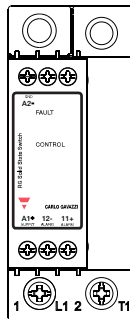

### RGC...90GGUP

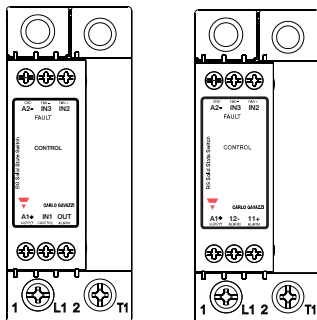

RGC..D90GGUP

RGC..A90GGUP

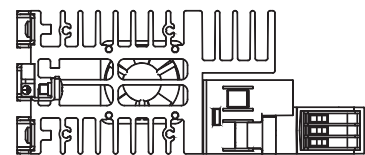
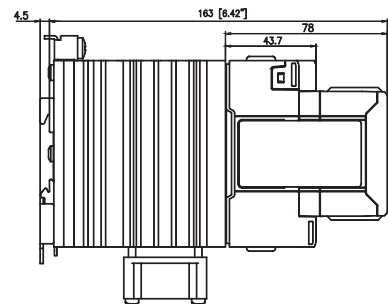
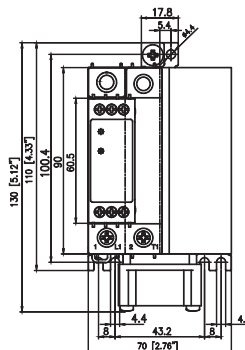

- 1/L1: Supply connection
- 2/T1: Load connection
- A1 (+): Positive control signal  
(Positive supply in case of RGC1A60D90GGUP)
- A2 (-): Control ground
- IN1: Control signal (only for RGC1A60D90GGUP)
- IN2: Fan + supply (only for RGC1A60A90GGUP)
- IN3: Fan - supply (only for RGC1A60A90GGUP)
- 11 + : Alarm output (+)
- OUT, 12 - : Alarm output (-)







: Protective earth

Housing width tolerance +0.5mm, -0mm...as per DIN43880.  
All other tolerances ± 0.5mm. All dimensions in mm.

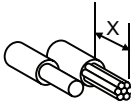
## Connection Specifications

### POWER CONNECTIONS: 1/L1, 2 /T1

Use 75°C copper (Cu) conductors

	<b>RG..KGU</b> (RG..15, 20, 25, 30)	<b>RG..KGU, RG..GGUP</b> (RG..40, 42, 60, 62, 90)
<b>Stripping Length (X)</b>	12 mm	11 mm
<b>Connection type</b>	M3.5 screw with box clamp	M5 screw with box clamp
<b>Rigid (Solid &amp; Stranded)</b> UL/ cUL rated data	 1 x 1..6 mm <sup>2</sup> 1 x 18.. 10 AWG	 1 x 2.5..25 mm <sup>2</sup> 1 x 14...3 AWG
<b>Flexible with end sleeve</b>	 1 x 0.5..2.5 mm <sup>2</sup> 1 x 20.. 14 AWG	 1 x 2.5..16 mm <sup>2</sup> 1 x 14.. 6 AWG
<b>Flexible without end sleeve</b>	 1 x 1.. 4 mm <sup>2</sup> 1 x 18.. 12 AWG	 1 x 4.. 25 mm <sup>2</sup> 1 x 12.. 3 AWG
<b>Torque specifications</b>	 Pozidriv 1 UL: 1.0 Nm (8.85 lb-in) IEC: 0.9 - 1.1 Nm (8 - 9.7 lb-in)	 Pozidriv 2 UL: 2.5 Nm (22 lb-in) IEC: 2.5 - 3.0 Nm (22 - 26.6 lb-in)
<b>Protective Earth (PE) Connection</b>	 1.5 Nm (13.3 lb-in)	

Note: M5 PE screw not provided with SSR. PE connection required when product is intended to be used in Class 1 applications according to EN/IEC 61140.

### CONTROL CONNECTIONS: A1(+), A2(-)

Use 60/75°C copper (Cu) conductor

#### Torque specifications

#### RG...KGU

M3, Pozidri v 1  
UL: 0.5 Nm (4.4lb-in)  
IEC: 0.5 - 0.6 Nm (4.4 - 5.3 lb-in)

#### Stripping Length (X)

8 mm

#### Rigid (Solid & Stranded)

UL/ cUL rated data

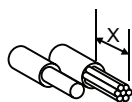

  
2 x 0.5..2.5 mm<sup>2</sup>    1 x 0.5..2.5 mm<sup>2</sup>  
2 x 18..12 AWG    1 x 18..12 AWG

#### Flexible with end sleeve



2 x 0.5..2.5 mm<sup>2</sup>    1 x 0.5..2.5 mm<sup>2</sup>  
 2 x 18..12 AWG    1 x 18..12 AWG

### CONTROL CONNECTIONS: A1(+), A2(-), IN1, IN2, IN3, 11 (+), 12(-), OUT

Use 60/75°C copper (Cu) conductors

#### Torque specifications

#### RG...GGUP

M3, Pozidriv 1  
UL: 0.5 Nm (4.4 lb-in)  
IEC: 0.4 - 0.5 Nm (3.5 - 4.4 lb-in)

#### Stripping Length (X)

6 mm

#### Rigid (Solid & Stranded)

UL/ cUL rated data

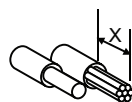



  
2 x 1.0..2.5 mm<sup>2</sup>    1 x 1.0..2.5 mm<sup>2</sup>  
2 x 18..14 AWG    1 x 18..14 AWG

#### Flexible with end sleeve

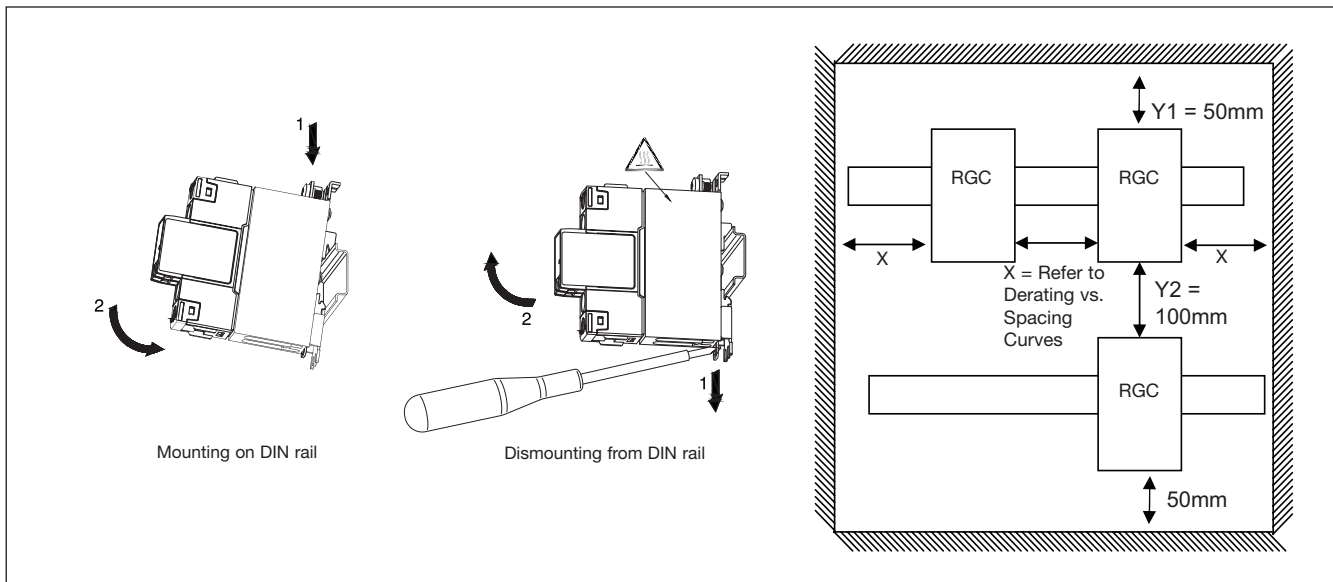

2 x 1.0..2.5 mm<sup>2</sup>    1 x 1.0..2.5 mm<sup>2</sup>  
 2 x 18..14 AWG    1 x 18..14 AWG

## Installation Instructions



## Short Circuit Protection

### Protection Co-ordination, Type 1 vs Type 2:

Type 1 protection implies that after a short circuit, the device under test will no longer be in a functioning state. In type 2 co-ordination the device under test will still be functional after the short circuit. In both cases, however the short circuit has to be interrupted. The fuse between enclosure and supply shall not open. The door or cover of the enclosure shall not be blown open. There shall be no damage to conductors or terminals and the conductors shall not separate from terminals. There shall be no breakage or cracking of insulating bases to the extent that the integrity of the mounting of live parts is impaired. Discharge of parts or any risk of fire shall not occur.

The product variants listed in the table hereunder are suitable for use on a circuit capable of delivering not more than 100,000A rms Symmetrical Amperes, 600 Volts maximum when protected by fuses. Tests at 100,000A were performed with Class J fuses, fast acting; please refer to the table below for maximum allowed ampere rating of the fuse. Use fuses only.

Tests with class J fuses are representative of Class CC fuses.

## Co-ordination type 1 (UL508)

Part No.	Prospective short circuit current [kArms]	Max. fuse size [A]	Class	Voltage [VAC]
RGC..15	100	10	J	max. 600
	100	15	CC	max. 600
RGC..20	100	10	J	max. 600
	100	15	CC	max. 600
RGC..25	100	30	J or CC	max. 600
RGC..30	100	30	J or CC	max. 600
RGC..40	100	40	J	max. 600
RGC..42	100	90	J	max. 600
RGC..60	100	40	J	max. 600
RGC..62	100	90	J	max. 600
RGC..90	100	40	J	max. 600

## Co-ordination type 2 (IEC EN 60947-4-2/ -4-3)

Part No.	Prospective short circuit current [kArms]	Mersen (Ferraz Shawmut)		Siba		Voltage [VAC]
		Max fuse size [A]	Part number	Max fuse size [A]	Part number	
RGC..15	10	25	6.9xx CP GRC 14x51 /25	32	50 142 06.32	max. 600
	100	25	6.9xx CP GRC 14x51 /25	32	50 142 06.32	max. 600
RGC..20	10	40	6.6xx CP URD 22x58 /40	32	50 142 06.32	max. 600
	100	40	6.6xx CP URD 22x58 /40	32	50 142 06.32	max. 600
RGC..25	10	40	6.9xx CP GRC 22x58 /40	32	50 142 06.32	max. 600
	100	40	6.6xx CP URD 22x58 /40	32	50 142 06.32	max. 600
RGC..30	10	40	6.9xx CP GRC 22x58 /40	32	50 142 06.32	max. 600
	100	40	6.6xx CP URD 22x58 /40	32	50 142 06.32	max. 600
RGC..40	10	63	6.621 CP URGD 27x60 /63	63	50 194 20.63	max. 600
	10	70	A70QS70-4	63	50 194 20.63	max. 600
	100	63	6.621 CP URQ 27x60 /63	63	50 194 20.63	max. 600
RGC..42	10	63	6.9xx CP URC 14x51 /63	80	50 194 20.80	max. 600
	10	70	A70QS70-4	80	50 194 20.80	max. 600
	100	63	6.9xx CP URC 14x51 /63	80	50 194 20.80	max. 600
	100	70	A70QS70-4	80	50 194 20.80	max. 600
RGC..60 up to 65AAC	10	80	6.621 CP URQ 27x60 /80	80	50 194 20.80	max. 600
	100	n/a	n/a	80	50 194 20.80	max. 600
RGC..62	10	100	6.9xx CP GRC 22x58 /100	100	50 194 20.100	max. 600
	10	100	A70QS100-4	100	50 194 20.100	max. 600
	100	100	6.621 CP URGD 27x60 /100	100	50 194 20.100	max. 600
	100	100	A70QS100-4	100	50 194 20.100	max. 600
RGC..90 up to 80AAC	10	100	6.621 CP URQ 27x60 /100	100	50 194 20.100	max. 600
	10	100	A70QS100-4	100	50 194 20.100	max. 600
	100	n/a	n/a	100	50 194 20.100	max. 600

## Type 2 Protection with Miniature Circuit Breakers (M.C.B.s)

Solid State Relay type	ABB Model no. for Z - type M. C. B. (rated current)	ABB Model no. for B - type M. C. B. (rated current)	Wire cross sectional area [mm <sup>2</sup> ]	Minimum length of Cu wire conductor [m] <sup>14</sup>	
<b>RGC..15</b> <b>RGC..20</b> (525 A <sup>2</sup> s)	1 pole				
	S201 - Z4 (4A)	S201 - B2 (2A)	1.0	21.0	
	S201 - Z6 UC (6A)	S201 - B2 (2A)	1.0 1.5	21.0 31.5	
<b>RGC..25</b> <b>RGC..30</b> (1800 A <sup>2</sup> s)	1 pole				
	S201 - Z10 (10A)	S201-B4 (4A)	1.0 1.5 2.5	7.6 11.4 19.0	
	S201 - Z16 (16A)	S201-B6 (6A)	1.0 1.5 2.5 4.0	5.2 7.8 13.0 20.8	
	S201 - Z20 (20A)	S201-B10 (10A)	1.5 2.5	12.6 21.0	
	S201 - Z25 (25A)	S201-B13 (13A)	2.5 4.0	25.0 40.0	
	2 pole				
	S202 - Z25 (25A)	S202-B13 (13A)	2.5 4.0	19.0 30.4	
	<b>RGC..40</b> (3200 A <sup>2</sup> s)	1 pole			
		S201 - Z25 (25A)	S201-B13 (13A)	2.5 4.0 6.0	7.0 11.2 16.8
		<b>RGC..60</b> (3200 A <sup>2</sup> s)	1 pole		
	S201 - Z25 (25A)		S201-B13 (13A)	2.5 4.0 6.0	7.0 11.2 16.8
	<b>RGC..90GGUP</b> (6600 A <sup>2</sup> s)		1 pole		
S201 - Z20 (20A)		S201-B10 (10A)	1.5 2.5 4.0	4.2 7.0 11.2	
S201 - Z32 (32A)		S201-B16 (16A)	2.5 4.0 6.0	13.0 20.8 31.2	
2 pole					
S202 - Z20 (20A)		S202-B10 (10A)	1.5 2.5 4.0	1.8 3.0 4.8	
S202 - Z32 (32A)		S202-B16 (16A)	2.5 4.0 6.0 10.0	5.0 8.0 12.0 20.0	
S202 - Z50 (50A)		S202-B25 (25A)	4.0 6.0 10.0	14.8 22.2 37.0	
<b>RGC..42</b> <b>RGC..62</b> (18000 A <sup>2</sup> s)		1 pole			
		S201-Z32 (32A)	S201-B16 (16A)	2.5 4.0 6.0	3.0 4.8 7.2
		S201-Z50 (50A)	S201-B25 (25A)	4.0 6.0 10.0 16.0	4.8 7.2 12.0 19.2
		S201-Z63 (63A)	S201-B32 (32A)	6.0 10.0 16.0	7.2 12.0 19.2

14. Between MCB and Load (including return path which goes back to the mains).

Note: A prospective current of 6kA and a 230/400V power supply system is assumed for the above suggested specifications. For cables with different cross section than those mentioned above please consult Carlo Gavazzi's Technical Support Group.

## Environmental Information

The declaration in this section is prepared in compliance with People's Republic of China Electronic Industry Standard SJ/T11364-2014: Marking for the Restricted Use of Hazardous Substances in Electronic and Electrical Products.

Part Name	Toxic or Harardous Substances and Elements					
	Lead (Pb)	Mercury (Hg)	Cadmium (Cd)	Hexavalent Chromium (Cr(VI))	Polybrominated biphenyls (PBB)	Polybrominated diphenyl ethers (PBDE)
Power Unit Assembly	x	○	○	○	○	○

O: Indicates that said hazardous substance contained in homogeneous materials for this part are below the limit requirement of GB/T 26572.

X: Indicates that said hazardous substance contained in one of the homogeneous materials used for this part is above the limit requirement of GB/T 26572.

## 环境特性

这份申明根据中华人民共和国电子工业标准 SJ/T11364-2014：标注在电子电气产品中限定使用的有害物质

零件名称	有毒或有害物质与元素					
	铅 (Pb)	汞 (Hg)	镉 (Cd)	六价铬 (Cr(VI))	多溴化联苯 (PBB)	多溴联苯醚 (PBDE)
功率单元	x	○	○	○	○	○

O: 此零件所有材料中含有的该有害物低于GB/T 26572的限定。

X: 此零件某种材料中含有的该有害物高于GB/T 26572的限定。



## Accessories

---

### Packaging



### Ordering Key

---

Bulk packing of 20 pcs.

**RGC...X20**

Applicable only to RGC..15 and  
RGC..25 models