

KEMET Part Number: R82EC1680DQ50K
(82EC1680DQ50K)

KEMET

a YAGEO company

R82, Film, Metallized Polyester Stacked, Automotive Grade, 6800 pF, 10%, 100 VDC, 85°C, Lead Spacing = 5mm

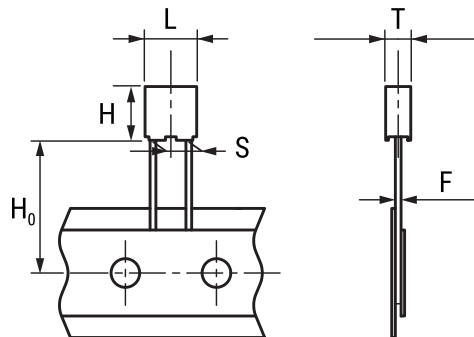

Dimensions

L	7.2mm +0.2mm
H	6.5mm +0.1mm
T	2.5mm +0.1mm
S	5mm +0.6/-0.1mm
H0	18.5mm +/-0.5mm
F	0.5mm +/-0.05mm

Packaging Specifications

Packaging:	Ammo, 360x340x59mm, Box
Packaging Quantity:	3500

General Information

Series:	R82
Dielectric:	Metallized Polyester Stacked
Style:	Radial
Features:	Automotive Grade, DC Multipurpose Applications
RoHS:	Yes
Lead:	Wire Leads
Qualifications:	AEC-Q200
AEC-Q200:	Yes
Component Weight:	0.331 g
Miscellaneous:	Above 85C DC And AC Voltage Derating Is 1.25%/C.

Specifications

Capacitance:	6800 pF
Capacitance Tolerance:	10%
Voltage AC:	63 VAC
Voltage DC:	100 VDC
Temperature Range:	-55/+105°C
Rated Temperature:	85°C
Dissipation Factor:	0.8% 1kHz, 1.2% 10kHz, 2.5% 100kHz
Insulation Resistance:	15 GOhms
Max dV/dt:	200 V/us
Inductance:	7 nH

Statements of suitability for certain applications are based on our knowledge of typical operating conditions for such applications, but are not intended to constitute - and we specifically disclaim - any warranty concerning suitability for a specific customer application or use. This Information is intended for use only by customers who have the requisite experience and capability to determine the correct products for their application. Any technical advice inferred from this Information or otherwise provided by us with reference to the use of our products is given gratis, and we assume no obligation or liability for the advice given or results obtained.

KEMET

a YAGEO company