

R1966 SERIES ROCKER SWITCH

ANTI-VANDAL SWITCHES
DETECTOR SWITCHES
DIP SWITCHES
KEYLOCK SWITCHES
NAVIGATION SWITCHES
PUSHBUTTON SWITCHES
ROCKER SWITCHES
ROTARY SWITCHES
SLIDE SWITCHES
SNAP ACTION SWITCHES
TACTILE SWITCHES
TOGGLE SWITCHES
CAP OPTIONS

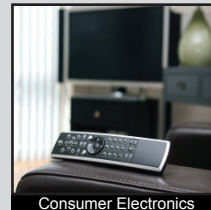

APPLICATIONS / MARKETS

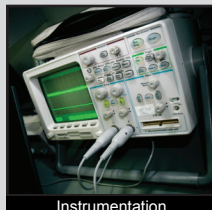
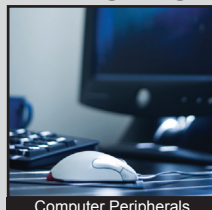

RoHS

SPECIFICATIONS

Contact Rating: 15A @ 125VAC UR, cUR
8A @ 250VAC UR, cUR
6A @ 250VAC VDE

Contact Arrangement: SPST, SPDT

Electrical Life: 10,000 cycles

Mechanical Life: 30,000 cycles

Insulation Resistance: >1000 MΩ

Dielectric Strength: 1,500VAC for 1 minute

Operating Temperature: -30°C to 65°C

Storage Temperature: -30°C to 80°C

Panel Thickness: 0.7mm to 3.0mm

FEATURES & BENEFITS

- Agency approvals: cURus, VDE
- SPST and SPDT
- LED Illumination options
- Multiple circuit functions
- Multiple termination options
- Actuator marking available

PART NUMBER CONFIGURATOR

Series	Circuit	Housing Color	Actuator Color	Marking (see chart)	Termination	LED Color*
<input type="text" value="R"/> <input type="text" value="1"/> <input type="text" value="9"/> <input type="text" value="6"/> <input type="text" value="6"/>	<input type="text" value="A"/>	<input type="text" value="B"/> <input type="text" value="L"/> <input type="text" value="K"/>	<input type="text" value="B"/> <input type="text" value="L"/> <input type="text" value="W"/>	<input type="text" value="A"/>	<input type="text" value="F"/>	<input type="text" value="R"/>
R1966	A - SPST, On-Off C - SPDT, On-On D - SPDT, On-Off-On E - SPST, On-(Off) F - SPST, Off-(On) G - SPDT, On-(On) H - SPDT, On-Off-(On) I - SPDT, (On)-Off-(On)	BLK - Black WHT - White GRY - Grey	BLK - Black RED - Red WHT - White	A B C D E F G H I	F - 0.187 QC .031 thk G - 0.187 QC .020 thk S - Solder Lug P - PCB Pins R - Right Angle PCB Pins L - Left Angle PCB Pins	RED - Red GRN - Green BLU - Blue YEL - Yellow

NOTES:

* LED Color option only available with the "A" circuit option
From the "A" circuit option with either the "R" or "L" terminal option, the LED terminals are solder lug terminals and are not bent in either the right or left angle terminal direction as the switch terminals. They protrude straight out from the switch body.

Specifications subject to change without notice



E-SWITCH®

www.e-switch.com

800.867.2717

1

R1966 SERIES ROCKER SWITCH

BODY DIMENSIONS

ILLUMINATED

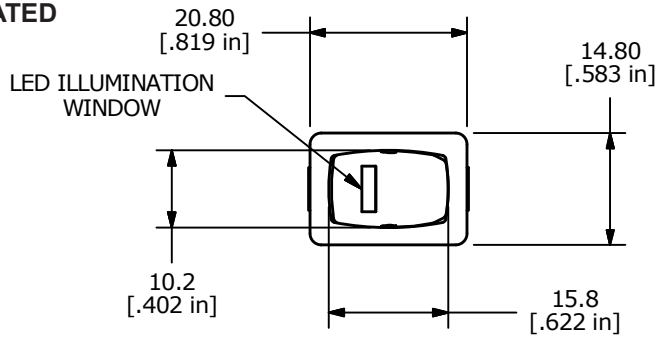

WHEN LED IS USED WITH TRMINALS	DIM "Y"
F, G, P, L, R	6.1 (0.24)
S	1.7 (0.07)

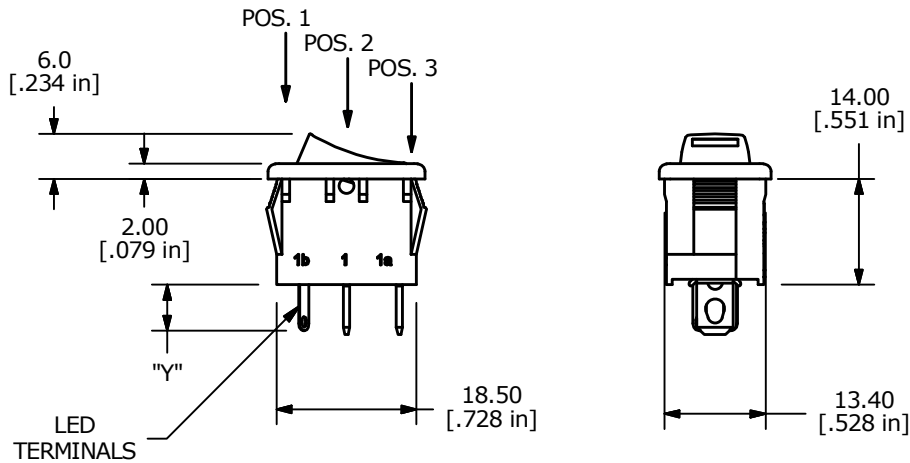

BODY DIMENSIONS

NON ILLUMINATED

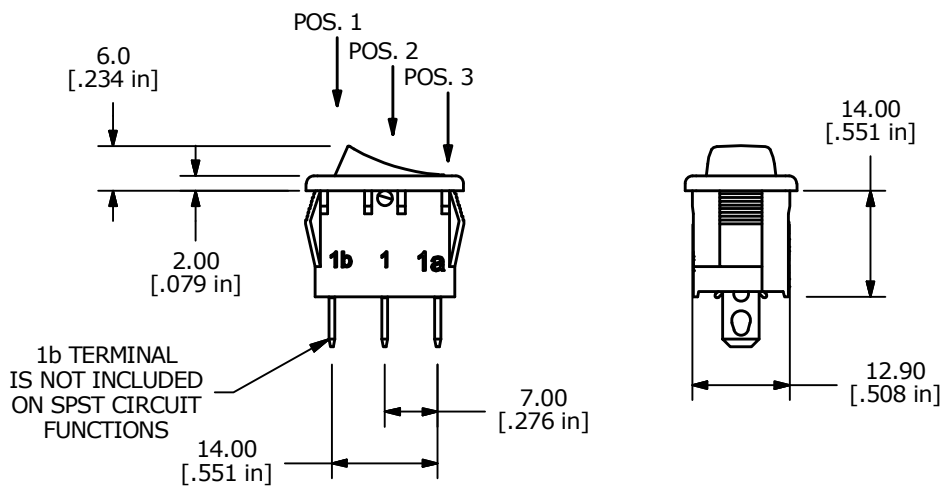
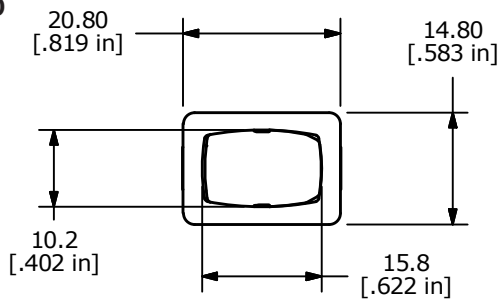

ANTI-VANDAL SWITCHES
 DETECTOR SWITCHES
 DIP SWITCHES
 KEYLOCK SWITCHES
 NAVIGATION SWITCHES
 PUSHBUTTON SWITCHES
ROCKER SWITCHES
 ROTARY SWITCHES
 SLIDE SWITCHES
 SNAP ACTION SWITCHES
 TACTILE SWITCHES
 TOGGLE SWITCHES
 CAP OPTIONS

R1966 SERIES ROCKER SWITCH

TERMINATION OPTIONS

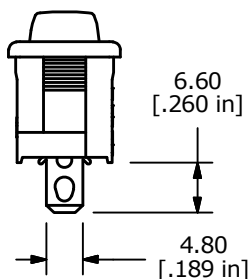
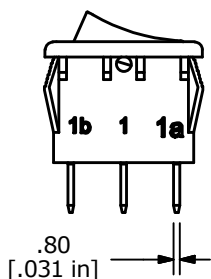

"F" TERMINAL

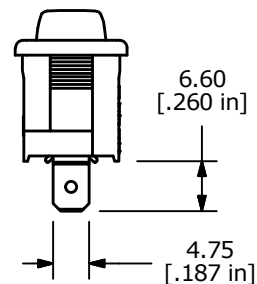
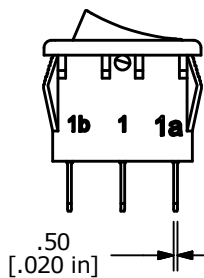

"G" TERMINAL

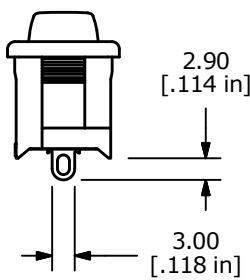
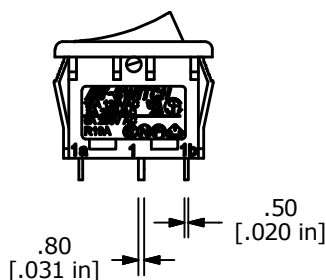

"S" TERMINAL

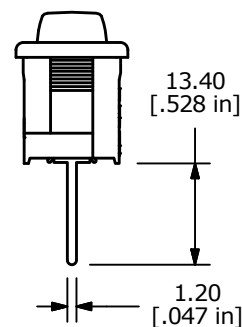
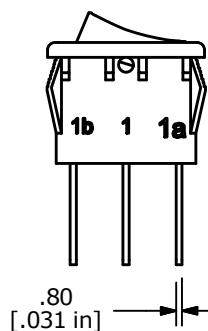

"P" TERMINAL

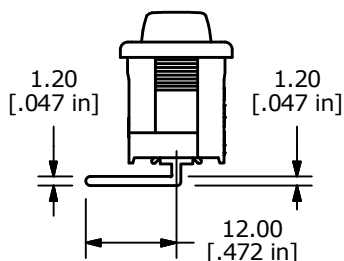
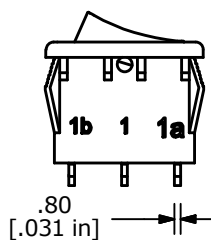

"R" TERMINAL

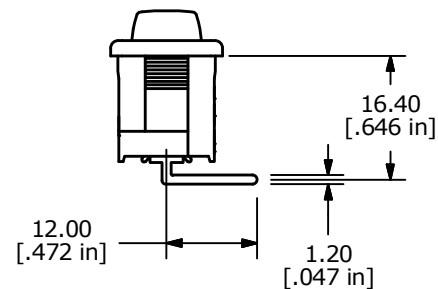
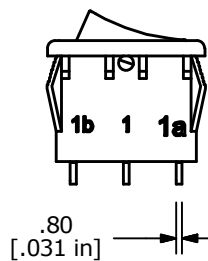

"R" TERMINAL

FUNCTION CHART

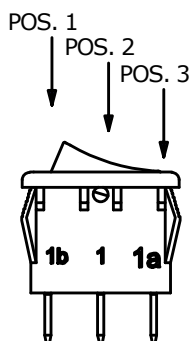

R1966 - SINGLE POLE TERMINAL CHART				
VERSION	FUNCTION OPTION	POS. 1	POS. 2	POS. 3
SPST	A - 1 POLE	ON	NONE	OFF
SPDT	C - 1 POLE	ON	NONE	ON
SPDT	D - 1 POLE	ON	OFF	ON
SPST	E - 1 POLE	ON	NONE	(OFF)
SPST	F - 1 POLE	OFF	NONE	(ON)
SPDT	G - 1 POLE	ON	NONE	(ON)
SPDT	H - 1 POLE	ON	OFF	(ON)
SPDT	I - 1 POLE	(ON)	OFF	(ON)
SPST	TERMINAL CLOSURE	1a-1	OPEN	N/A
SPDT	TERMINAL CLOSURE	1a-1	OPEN	1-1b

() DENOTES = MOMENTARY



R1966 SERIES ROCKER SWITCH

MARKING OPTIONS

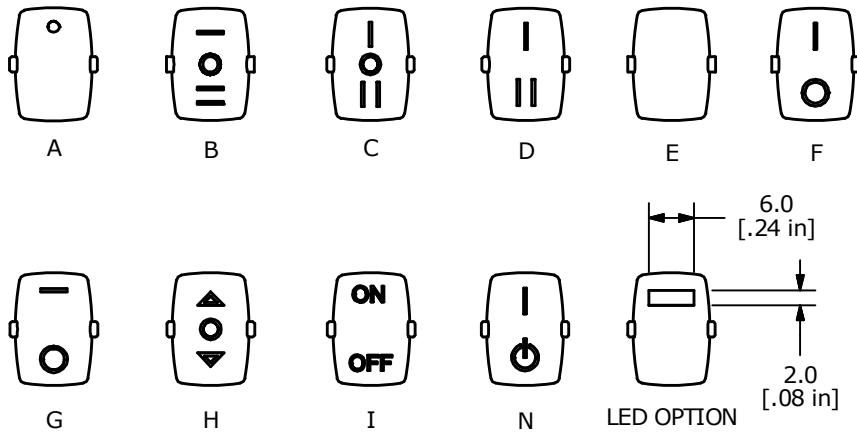

SCHEMATICS & LAYOUTS

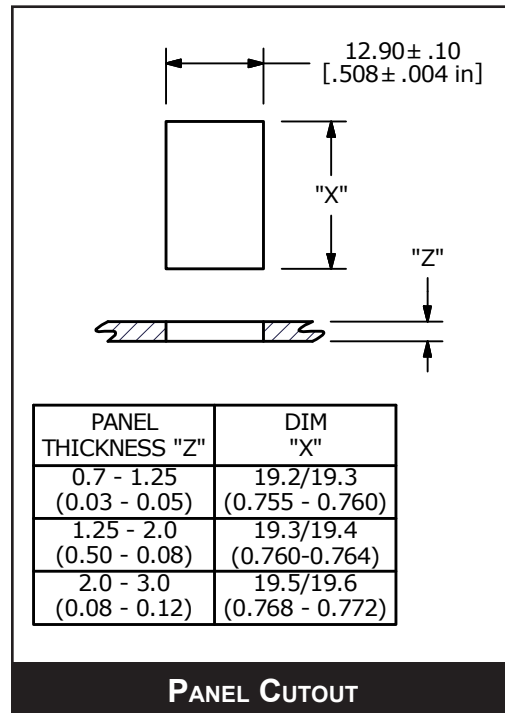
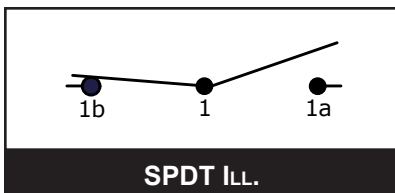
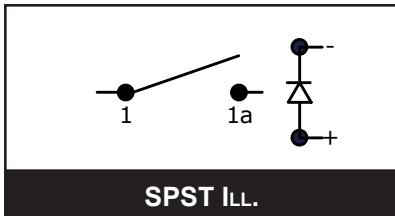
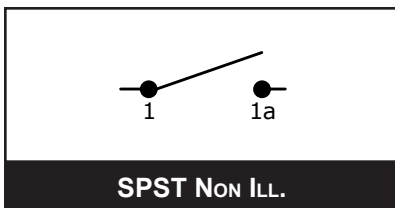
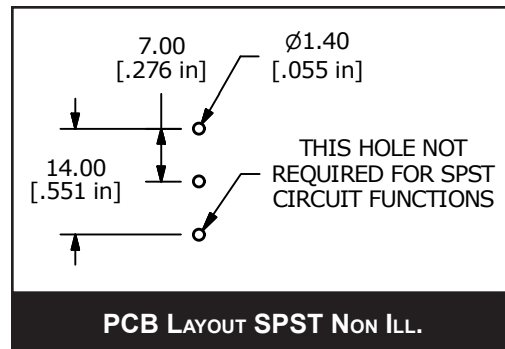
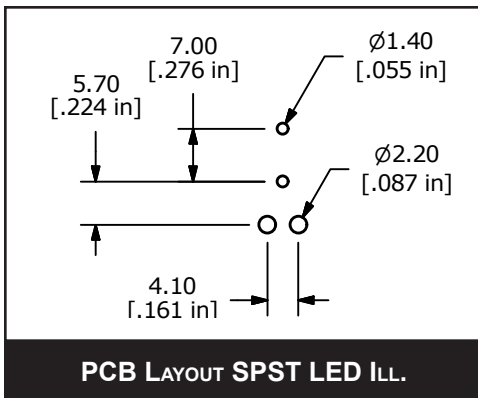

ANTI-VANDAL SWITCHES
DETECTOR SWITCHES
DIP SWITCHES
KEYLOCK SWITCHES
NAVIGATION SWITCHES
PUSHBUTTON SWITCHES
ROCKER SWITCHES
ROTARY SWITCHES
SLIDE SWITCHES
SNAP ACTION SWITCHES
TACTILE SWITCHES
TOGGLE SWITCHES
CAP OPTIONS