

Datasheet

Miniature self-contained photoelectric sensors in universal housing



- Easily fits (or retrofits) almost any mounting situation
- Exceptional optical performance, comparable to larger "MINI-style" or barrel sensors
- 10 to 30 V dc operation, with complementary (SPDT) NPN or PNP outputs, depending on model
- Bright LED operating status indicators are visible from 360°
- Rugged sealed housing, protected circuitry
- Models available with or without 18 mm threaded "nose"
- Less than 1 millisecond output response for excellent sensing repeatability
- Choose 2 m (6.5 ft) or 9 m (30 ft) cable or 150 mm (6 inch) Pico-style pigtail QD



WARNING: Not To Be Used for Personnel Protection

Never use this device as a sensing device for personnel protection. Doing so could lead to serious injury or death. This device does not include the self-checking redundant circuitry necessary to allow its use in personnel safety applications. A sensor failure or malfunction can cause either an energized or de-energized sensor output condition.







Models

To order the 9 m (30 ft) cable models, add the suffix "W/30" to the cabled model number.

QD Models. For 4-pin integral Euro-style QD, add suffix "Q8" (for example, QS186EQ8). For 4-pin integral Pico-style QD, add suffix "Q7" (for example, QS186EQ7). For 4-pin 150 mm (6 in) Euro-style pigtail, add suffix "Q5" (for example, QS186EQ5). For 4-pin 150 mm (6 in) Pico-style pigtail, add suffix "Q" (for example, QS186EQ).

Opposed Mode	Model	Range	Output
Effective beam: 13 mm (0.5 inch) 	QS186EV (624 nm Visible Red)	20 m (66 ft)	N/A
	QS186E (940 nm Infrared)		N/A
	QS18VN6R		NPN
	QS18VP6R		PNP
Effective beam: 13 mm (0.5 inch) 	QS186EB (940 nm Infrared)	3 m (10 ft)	N/A
	QS18VN6RB		NPN
	QS18VP6RB		PNP
Polarized Retroreflective Mode	Model	Range	Output
630 nm Visible Red 	QS18VN6LP	3.5 m (12 ft)	NPN
	QS18VP6LP		PNP
Retroreflective Mode	Model	Range	Output
628 nm Visible Red 	QS18VN6LV	6.5 m (21 ft)	NPN
	QS18VP6LV		PNP



Convergent Mode	Model	Range	Output
630 nm Visible Red 	QS18VN6CV15	16 mm (0.63 in)	NPN
	QS18VP6CV15		PNP
	QS18VN6CV45	43 mm (1.7 in)	NPN
	QS18VP6CV45		PNP
Diffuse Mode	Model	Range	Output
940 nm Infrared 	QS18VN6D	450 mm (18 in)	NPN
	QS18VP6D		PNP
	QS18VN6DB (Diffuse, wide)		NPN
	QS18VP6DB (Diffuse, wide)		PNP
Divergent Mode	Model	Range	Output
940 nm Infrared 	QS18VN6W	100 mm (4 in)	NPN
	QS18VP6W		PNP
Fixed Field Mode	Model	Range	Output
660 nm Visible Red 	QS18VN6FF50	50 mm (2 in)	NPN
	QS18VP6FF50		PNP
	QS18VN6FF100	100 mm (4 in)	NPN
	QS18VP6FF100		PNP
Plastic Fiber Optic Mode	Model	Range	Output
660 nm Visible Red 	QS18VN6FP	Range varies by sensing mode and fiber optics used	NPN
	QS18VP6FP		PNP
Glass Fiber Optic Mode	Model	Range	Output
940 nm Infrared 	QS18VN6F	Range varies by sensing mode and fiber optics used	NPN
	QS18VP6F		PNP

Wiring Diagrams

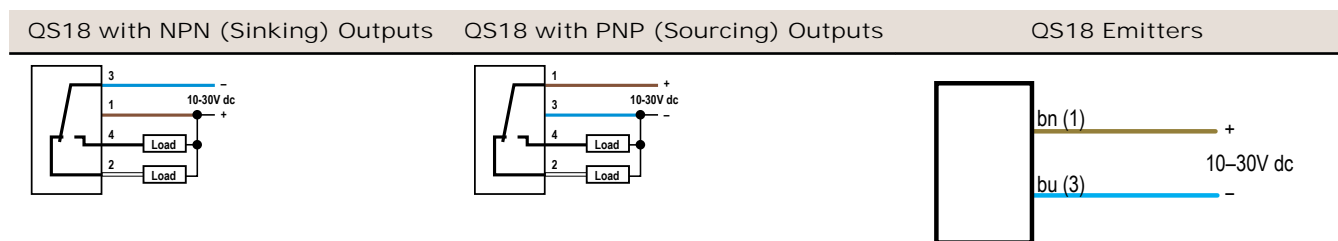

Installing Fibers

Cutting Unterminated Plastic Fibers QS18V..6FP

Unterminated plastic fibers are designed to be cut by the user to the length required for the application.

To facilitate cutting, a Banner model PFC-1 cutting device is supplied with the fiber. Cut the fiber as follows:

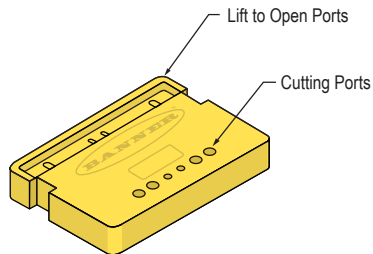

Figure 1. PFC-1 Cutting Device

Use small ports for fiber sizes:

- 0.25 mm (0.01 inches)
- 0.5 mm (0.02 inches)

Use large ports for fiber sizes:

- 0.75 mm (0.03 inches)
- 1.0 mm (0.04 inches)
- 1.5 mm (0.06 inches)

1. Locate the control end of the fiber (the unfinished end).
2. Determine the length of fiber required for the application. If using a bifurcated fiber, separate the two halves of the fiber at least 51 mm (2 inches) beyond the fiber cutting location.
3. Lift the top (blade) of the cutter to open the cutting ports.
4. Insert one of the control ends through one of the cutting ports on the cutter so that the excess fiber protrudes from the back of the cutter.
5. Double-check the fiber length, and close the cutter until the fiber is cut.
6. Using a different cutting port, cut the second control end to the required length.



NOTE: To ensure a clean cut each time, do not use a cutting port more than once.

7. Gently wipe the cut ends of the fiber with a clean, dry cloth to remove any contamination. Do not use solvents or abrasives on any exposed optical fiber.

Installing Plastic Fibers QS18V..6FP

Follow these steps to install the plastic fibers.

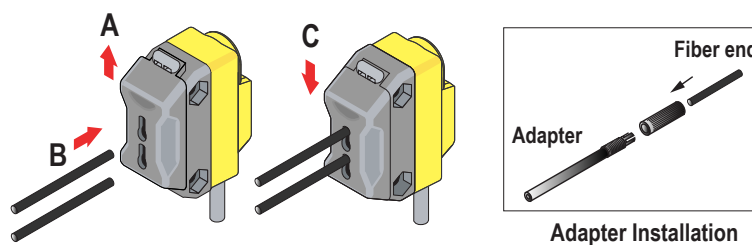

Figure 2. Installing Plastic Fibers

1. Slide the fiber gripper up to unlock it (A).
2. If using 0.25 mm or 0.5 mm core fibers, slide the plastic fiber adapters onto the fibers, flush with the fiber ends.
3. Carefully insert the prepared plastic fiber ends into the ports (B) as far as possible without applying extra force.
4. Slide the fiber gripper down to lock the fibers in place (C).

Installing Glass Fibers QS18V..6F

Follow these steps to install the glass fibers.

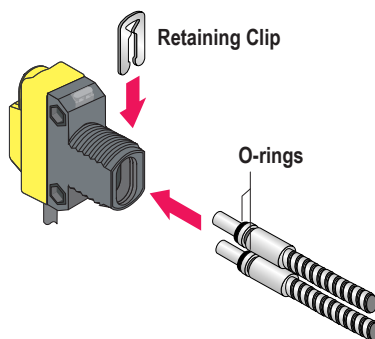

Figure 3. Installing Glass Fibers

1. Slide the supplied o-ring on the sensor end of the fibers, as shown.
2. Press the fiber ends firmly into the ports located on the front of the sensor.
3. Slide the supplied u-shaped retaining clip into the slot in the sensor's barrel until the clip snaps into place.

Specifications

Supply Voltage

10 to 30 V dc (10% maximum ripple) at less than 25 mA, exclusive of load;
Protected against reverse polarity and transient voltages

Light Source

Glass Fiber Optic, Opposed and Diffuse mode models: Infrared, 940 nm
Plastic Fiber Optic, Retroreflective, Convergent and FF mode models: Visible red, 660 nm

Adjustments

Glass Fiber Optic, Plastic Fiber Optic, Convergent, Diffuse, and Retroreflective mode models (only): Single-turn sensitivity (Gain) adjustment potentiometer

Indicators

2 LED indicators on sensor top:
Green solid: Power on
Amber solid: Light sensed
Green flashing: Output overloaded
Amber flashing: Marginal excess gain (1 to 1.5x excess gain)
Note: Prior to date code 0223, the output indicator was red.

Required Overcurrent Protection



WARNING: Electrical connections must be made by qualified personnel in accordance with local and national electrical codes and regulations.

Overcurrent protection is required to be provided by end product application per the supplied table.

Overcurrent protection may be provided with external fusing or via Current Limiting, Class 2 Power Supply.

Supply wiring leads < 24 AWG shall not be spliced.

For additional product support, go to <http://www.bannerengineering.com>.

Supply Wiring	Required Overcurrent Protection
20	5.0 Amps
22	3.0 Amps
24	2.0 Amps
26	1.0 Amps
28	0.8 Amps
30	0.5 Amps

Repeatability

Opposed Mode: 100 microseconds
FF Mode: 160 microseconds
All others: 150 microseconds

Output Configuration

Solid-state complementary (SPDT): NPN or PNP (current sinking or sourcing), depending on model;
Rating: 100 mA maximum each output at 25 °C
Off-state Leakage Current (FF Mode): less than 200 µA @ 30V dc
Off-state Leakage Current (All others): less than 50 µA @ 30V dc
ON-state Saturation Voltage: less than 1 V @ 10 mA; less than 1.5 V @ 100 mA
Protected against false pulse on power-up and continuous overload or short circuit of outputs

Output Response

Opposed Mode: 750 microseconds ON; 375 microseconds OFF
FF Mode: 850 microseconds ON/OFF
All others: 600 microseconds ON/OFF
Note: 100 millisecond delay on power-up; outputs do not conduct during this time

Construction

ABS housing
3 mm mounting hardware included

Connections

2 m (6.5 ft) 4-wire PVC cable, 9 m (30 ft) 4-wire PVC cable, 4-pin Pico-style or Euro-style QD, 4-pin Pico-style or Euro-style 150 mm (6 in) pigtail QD, depending on model

Environmental

IEC IP67; NEMA 6

Operating Conditions

Temperature: -20 °C to 70 °C (-4 °F to 158 °F)
Relative Humidity: 90% @ 50 °C (non-condensing)

Certifications—All models



Certifications—QS18Vx6FFxxx models



Dimensions and Features

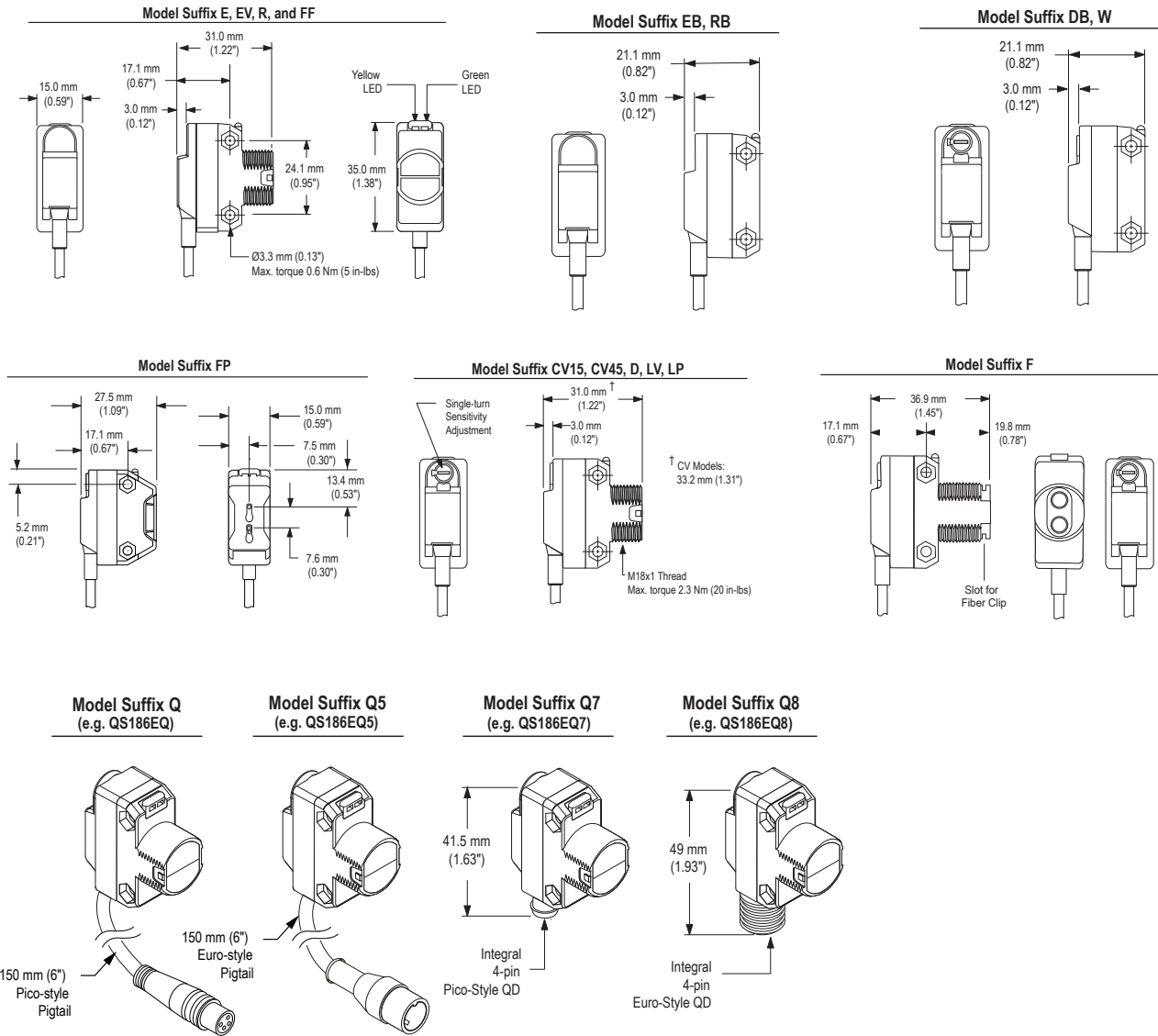

M18 x 1 Jam Nut

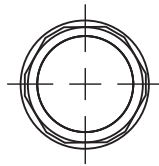
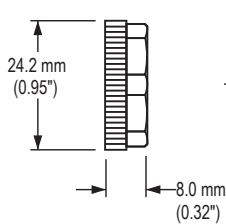

M3 hardware packet contents:

- 2 - M3 x 0.5 x 20 mm stainless steel screw
- 2 - M3 x 0.5 stainless steel hex nut
- 2 - M3 stainless steel washer

Packing List

- Sensor
- M18 x 1 jam nut
- M3 hardware packet
- Installation sheet, p/n 63687

Performance Curves

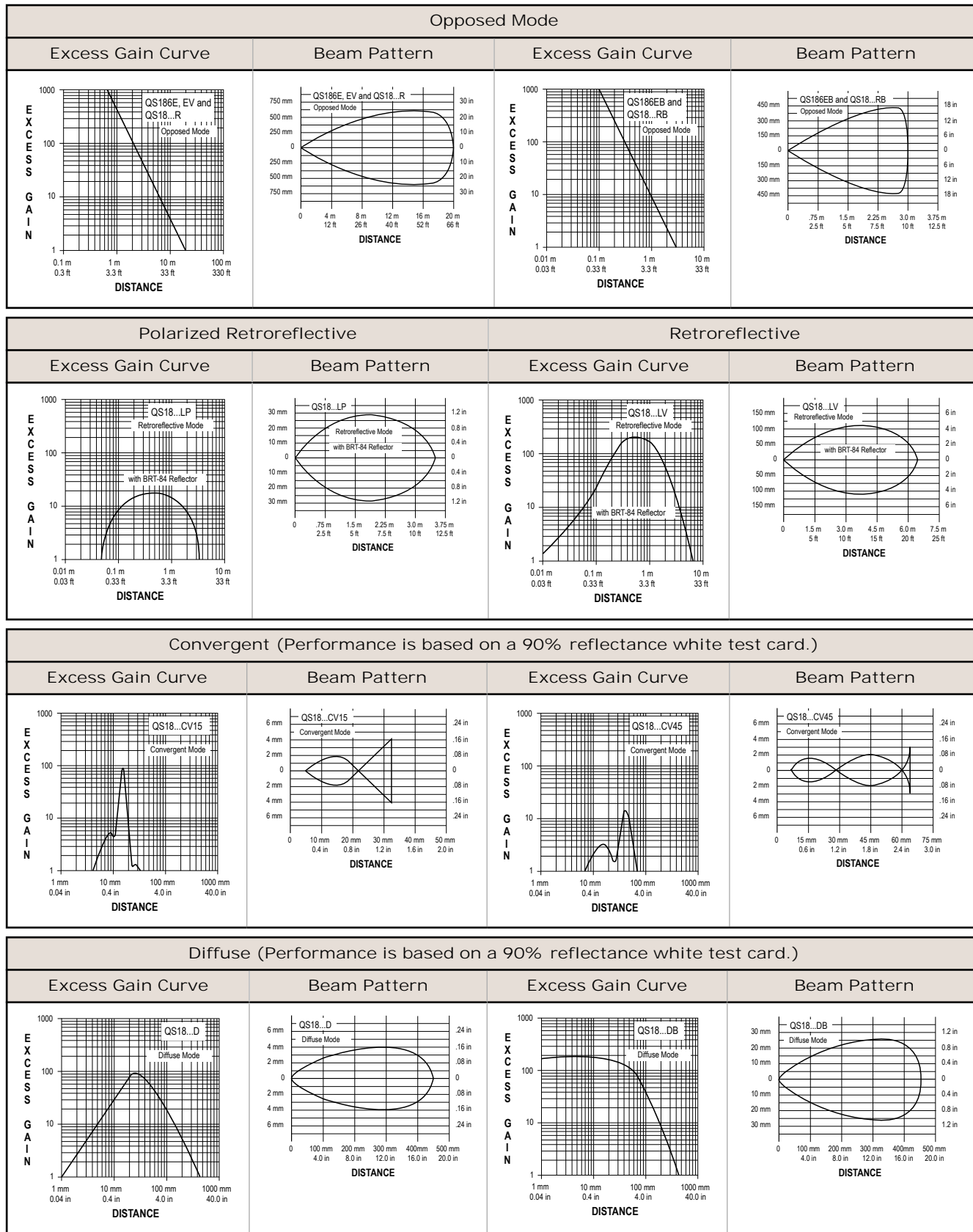

Divergent (Performance is based on a 90% reflectance white test card.)

Excess Gain Curve

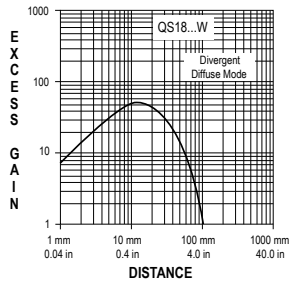

Beam Pattern

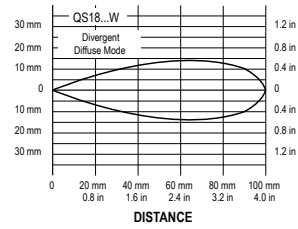

Fixed Field - 50 mm

Excess Gain Curve

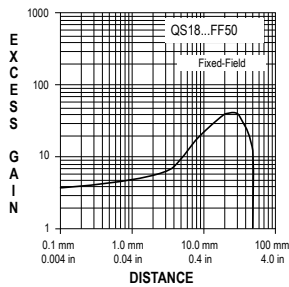

Spot Sizes

At 25 mm: 7.5 × 5.7 mm
At 50 mm: 6.3 × 4.9 mm

Fixed Field - 100 mm

Excess Gain Curve

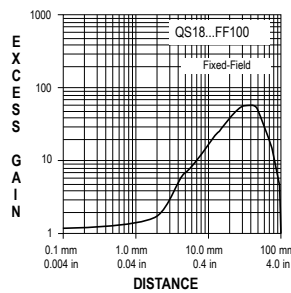

Spot Sizes

At 50 mm: 6.1 × 4.6 mm
At 100 mm: 2.9 × 2.9 mm

Opposed - Plastic Fiber

Excess Gain Curve

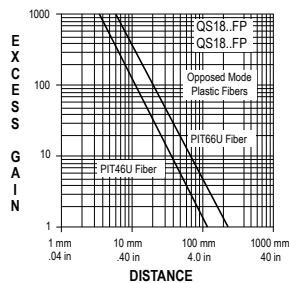

Beam Pattern

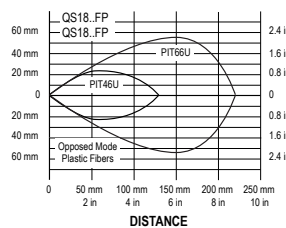

Bifurcated - Plastic Fiber (Performance is based on a 90% reflectance white test card.)

Excess Gain Curve

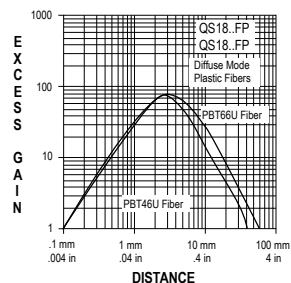

Beam Pattern

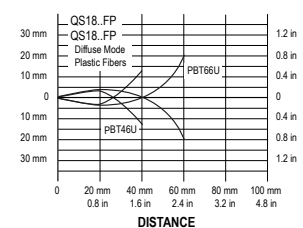

Opposed - Glass Fiber (Performance is based on a 90% reflectance white test card.)

Excess Gain Curve

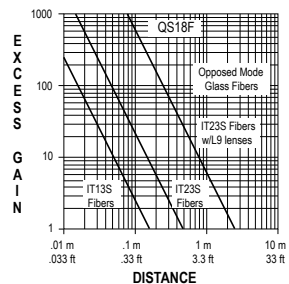

Beam Pattern

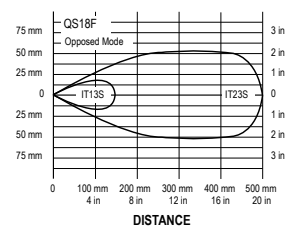

Bifurcated - Glass Fiber (Performance is based on a 90% reflectance white test card.)

Excess Gain Curve

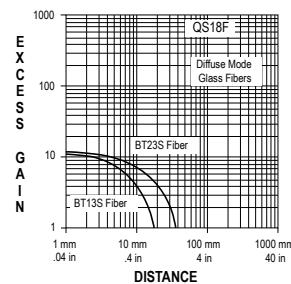

Beam Pattern

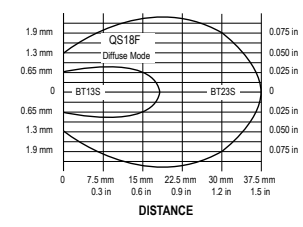

Accessories

Cordsets

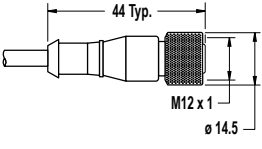
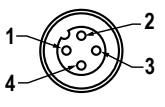
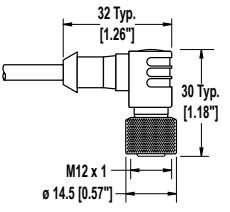
4-Pin Threaded M12/Euro-Style Cordsets				
Model	Length	Style	Dimensions	Pinout (Female)
MQDC-406	1.83 m (6 ft)	Straight		
MQDC-415	4.57 m (15 ft)			
MQDC-430	9.14 m (30 ft)			
MQDC-450	15.2 m (50 ft)			
MQDC-406RA	1.83 m (6 ft)	Right-Angle		1 = Brown 2 = White 3 = Blue 4 = Black
MQDC-415RA	4.57 m (15 ft)			
MQDC-430RA	9.14 m (30 ft)			
MQDC-450RA	15.2 m (50 ft)			

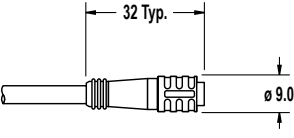
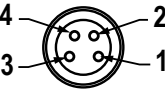
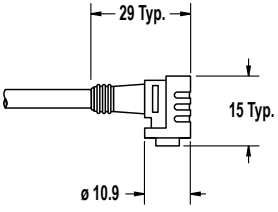
4-Pin Snap-on M8/Pico-Style Cordsets				
Model	Length	Style	Dimensions	Pinout (Female)
PKG4-2	2 m (6.56 ft)	Straight		
PKW4Z-2	2 m (6.56 ft)	Right-Angle		

WORLD-BEAM QS18 Brackets

SMB18A

- Right-angle mounting bracket with a curved slot for versatile orientation
- 12-ga. stainless steel
- 18 mm sensor mounting hole
- Clearance for M4 (#8) hardware

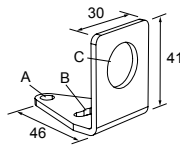

Hole center spacing: A to B = 24.2
 Hole size: A = ø 4.6, B = 17.0 x 4.6, C = ø 18.5

SMB312S

- Stainless steel 2-axis, side-mount bracket

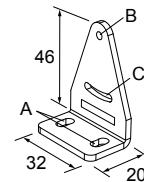

A = 4.3 x 7.5, B = diam. 3, C = 3 x 15.3

All measurements are in millimeters.

Retroreflective Targets

See the Accessories section of your current Banner Engineering Corp catalog for complete information.



NOTE: Polarized sensors require corner cube type retroreflective targets only.

Plastic and Glass Fiber Optics

See the Accessories section of your current Banner Engineering Corp catalog for a list of plastic and glass fiber optic cables.

Banner Engineering Corp Limited Warranty

Banner Engineering Corp. warrants its products to be free from defects in material and workmanship for one year following the date of shipment. Banner Engineering Corp. will repair or replace, free of charge, any product of its manufacture which, at the time it is returned to the factory, is found to have been defective during the warranty period. This warranty does not cover damage or liability for misuse, abuse, or the improper application or installation of the Banner product.

THIS LIMITED WARRANTY IS EXCLUSIVE AND IN LIEU OF ALL OTHER WARRANTIES WHETHER EXPRESS OR IMPLIED (INCLUDING, WITHOUT LIMITATION, ANY WARRANTY OF MERCHANTABILITY OR FITNESS FOR A PARTICULAR PURPOSE), AND WHETHER ARISING UNDER COURSE OF PERFORMANCE, COURSE OF DEALING OR TRADE USAGE.

This Warranty is exclusive and limited to repair or, at the discretion of Banner Engineering Corp., replacement. IN NO EVENT SHALL BANNER ENGINEERING CORP. BE LIABLE TO BUYER OR ANY OTHER PERSON OR ENTITY FOR ANY EXTRA COSTS, EXPENSES, LOSSES, LOSS OF PROFITS, OR ANY INCIDENTAL, CONSEQUENTIAL OR SPECIAL DAMAGES RESULTING FROM ANY PRODUCT DEFECT OR FROM THE USE OR INABILITY TO USE THE PRODUCT, WHETHER ARISING IN CONTRACT OR WARRANTY, STATUTE, TORT, STRICT LIABILITY, NEGLIGENCE, OR OTHERWISE.

Banner Engineering Corp. reserves the right to change, modify or improve the design of the product without assuming any obligations or liabilities relating to any product previously manufactured by Banner Engineering Corp.