



P.O. Box 2956 • Syracuse • New York • 13220
 Phone: (315) 433-1150 Fax: (315) 433-1521
 Toll Free US & Canada (800) 334-0837
 Email: sales@infitec.com

Q SERIES DIGITAL ENCAPSULATED TIME DELAY MODULES

FEATURES

- C/MOS Digital Circuitry
- Time Delays To 1000 Minutes
- No First Cycle Effect
- Fully Solid State And Encapsulated
- 0.5% Repeat Accuracy
- Seven Different Modes Of Operation
- Output Rated at 1 Ampere Continuous, 10 Amperes Inrush
- Fixed, Local Or Externally Adjustable Time Delays
- Small Size
- UL/cUL Recognized

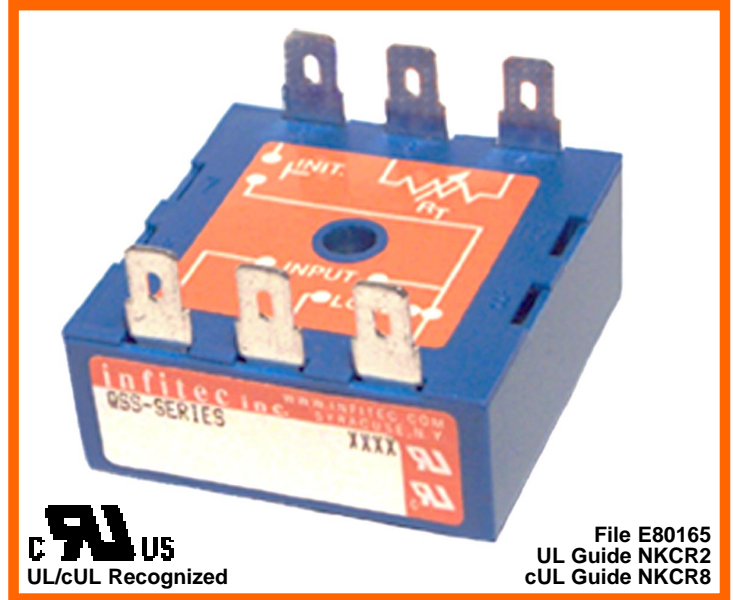

UL
UL/cUL Recognized

File E80165
UL Guide NKCR2
cUL Guide NKCR8

SPECIFICATIONS

1. Time Delay.

- 1.1 Type: C/MOS digital circuitry
- 1.2 Range: From 0.05 seconds to 1000 minutes.
Fixed delays available (see time delay chart)
- 1.3 Repeat accuracy: $\pm 0.5\%$ under fixed conditions
- 1.4 Setting accuracy: $\pm 10\%$
- 1.5 Reset time: 50 milliseconds maximum
- 1.6 Recycle time: 100 milliseconds during timing,
50 milliseconds after timing
- 1.7 Time delay vs. voltage and temperature: $\pm 2\%$

2. Input.

- 2.1 Operating voltage: 24, 120 & 230 VAC, 12 & 24/28 VDC
- 2.2 Tolerance: $\pm 20\%$ of nominal
- 2.3 Frequency: 50 - 60 Hertz

3. Output.

- 3.1 Type: Solid state
- 3.2 Form: SPST
- 3.3 Rating: 1 amp steady state, (10 amp inrush, 20 mA. min.)
- 3.4 Life: 100,000,000 operations minimum under full load

4. Protection.

- 4.1 Transient: ± 1500 volts for 150 microseconds
- 4.2 Polarity: DC units are reverse polarity protected
- 4.3 Dielectric breakdown: 1500 volts RMS minimum

5. Mechanical.

- 5.1 Mounting: One #8 or #10 screw
- 5.2 Termination: 1/4" quick connect terminals
- 5.3 Style: Surface mount encapsulated

6. Environmental.

- 6.1 Operating temperature: -20°C to $+80^{\circ}\text{C}$
- 6.2 Storage temperature: -30°C to $+85^{\circ}\text{C}$
- 6.3 Humidity: 95% relative non-condensing

MODE OF OPERATION - SERIES

DELAY ON MAKE - QMS, QMSA

Upon application of power to the input terminals, the time delay begins. At the completion of the pre-selected time delay, the output contact transfers. Reset is accomplished by removal of input power. There is no false output when reset during timing.

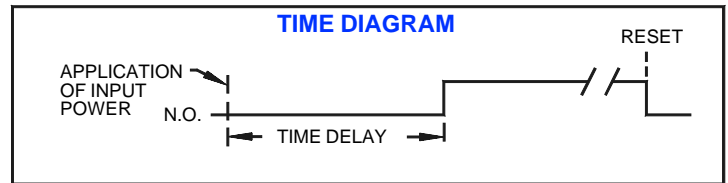

INTERVAL - QIS

Upon application of power to the input terminals, the output contact immediately transfers and the time delay begins. At the completion of the pre-selected time delay, the output contact reverts to its original position. Reset is accomplished by removal of input power.

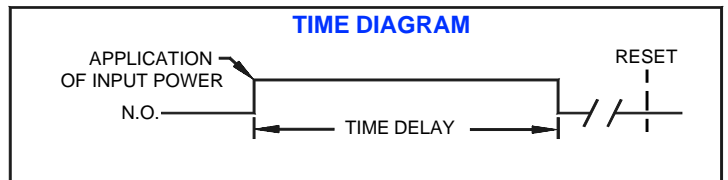

SINGLE SHOT - QSS

Power must be applied to the input at all times prior to and during timing. Upon closure of the initiate switch (momentary or maintained) the output contact transfers and the time delay begins. At the completion of the pre-selected delay period, the output contact reverts to its original position. Removal of input power will reset the control.

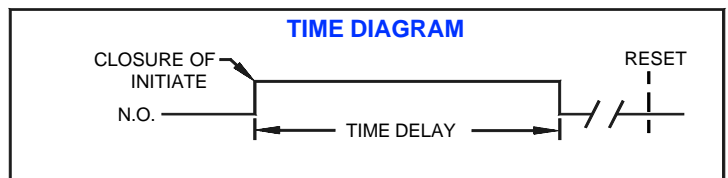

DELAY ON MAKE, NORMALLY CLOSED - QCS

The output is in a normally closed state. Upon application of power to the input terminals, the output contact transfers and the time delay begins. At the completion of the time delay the output contact drops out. Removal of input power from terminal 3 resets the delay and the output contact reverts to its original closed position.

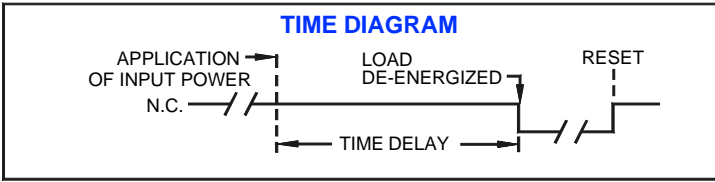

RETRIGGERABLE ONE-SHOT - QOS

Power must be applied to the input at all times prior to and during timing. Upon closure of the initiate switch (momentary or maintained) the output contact transfers and the time delay begins. At the completion of the pre-selected delay period, the output contact reverts to its original position. **NOTE:** Momentary or maintained closure of initiate switch during timing will reset the time delay.

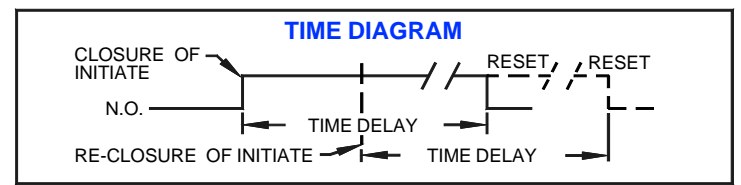

DELAY ON BREAK - QBS/QTS *

Power must be applied to the input at all times prior to and during timing. Upon closure of the initiate switch, the output contact transfers and remains transferred if no further action is taken. When the initiate switch is opened, the time delay begins. At the completion of the pre-selected delay period the output contact reverts to its original position. Closure of initiate during timing will reset the delay period. Removal of input power will reset the control.

*QTS is the same except it is trailing edge triggered. Load energizes when initiate switch is opened.

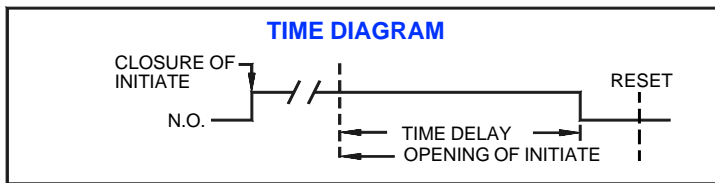

DIMENSIONS

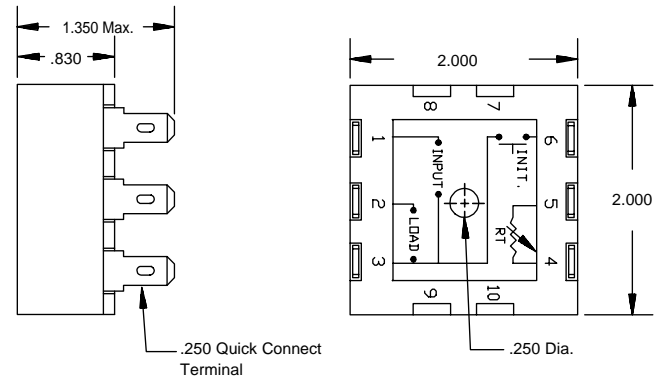

CONNECTION DIAGRAMS

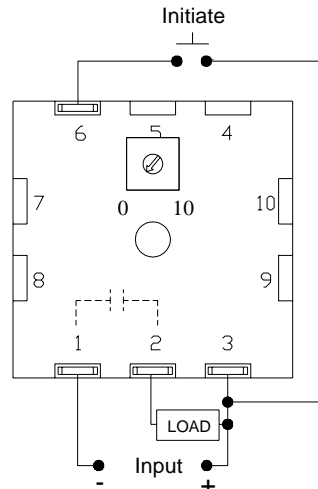

QBS/QOS/QSS/QTS
(Local Adjustment Shown)

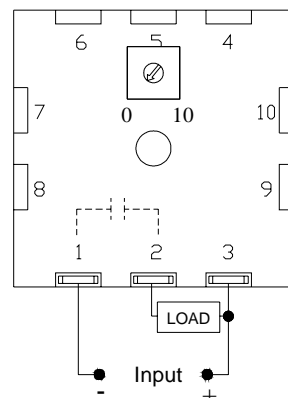

QIS/QMSA
(Local Adjustment Shown)

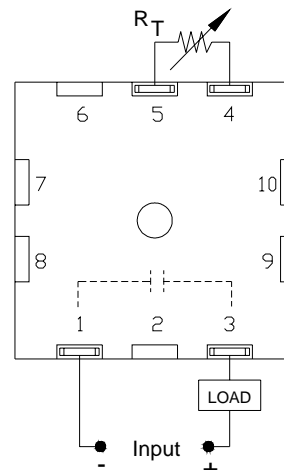

QMS
(External Adjustment Shown)

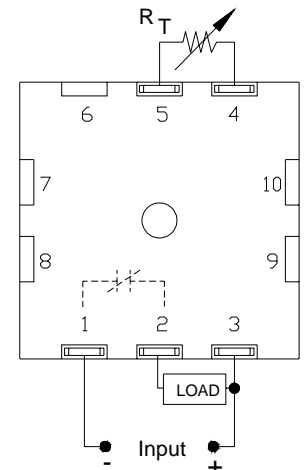

QCS
(External Adjustment Shown)

ORDERING INFORMATION

SERIES	INPUT VOLTAGE	ADJUSTMENT	TIME DELAY RANGE
QBS QCS QIS QMS QMSA QOS QSS QTS	1 - 12 VDC 2 - 24/28 VDC 4 - 24 VAC 5 - 120 VAC 6 - 230 VAC	0 - Local Adjust 1 - Fixed 2 - External Adjust	See Time Delay Range Chart