

# Q16 series

Ø16 mm panel mount LED indicators



## DISTINCTIVE FEATURES

Secret until lit polycarbonate decals or custom engraving  
 10 mm colored diffused epoxy lens or 10 mm water clear super bright LEDs  
 (2.8 x 0.8) solder lug/faston terminals, pins or (200 mm long) wire terminations  
 Available in RGB



## ENVIRONMENTAL SPECIFICATIONS

- IP67 sealing option (EN60529)
- Operating & Storage Temperature Range:  
**Rear plastic body:** -30 ° C to +65° C ( -22 °F to +149 °F)  
**Rear epoxy body:** -40 ° C to +85° C ( -40 °F to +185 °F)



## GENERAL SPECIFICATIONS

- Max Reverse Voltage: 5 V
- Viewing Angle: 30–100° (dependant on model)
- Life Expectancy: 100,000 hours
- Torque: 75 cNm
- Maximum panel thickness 11 mm



## MATERIALS

- Plated brass bezel finished in bright chrome, black or satin grey and moulded polycarbonate rear body



## MOUNTING

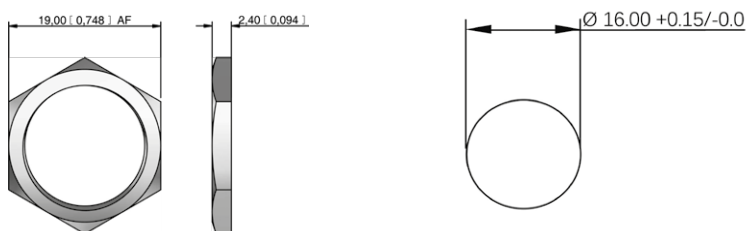

The company reserves the right to change specifications without notice.

All LED characteristics are dependent upon environmental conditions. Therefore published data should be considered nominal and subject to variations.



# Q16 series

Ø16 mm panel mount LED indicators



## ELECTRICAL SPECIFICATIONS

### STANDARD LED INTENSITY

LED COMPONENT SPECIFICATIONS			
	Prominent and Recessed	Flush	Forward Voltage
HE Red	80 mcd	10 mcd	2.0 V
Green	60 mcd	5 mcd	2.2 V
Yellow	50 mcd	4 mcd	2.1 V
Blue	540 mcd	100 mcd	3.3 V
White	1,000 mcd	150 mcd	3.3 V
Orange	80 mcd	200 mcd	2.2 V
Bi-color (Typical) (Red/Green)	15/15 mcd	14/10 mcd	2.0 V/2.2 V
Tri-color (Typical) (Red/Green/Yellow)	60/50/50 mcd	15/10/30 mcd	2.0 V/2.2 V/2.1 V

Bi-color - The color is changed by reversing the polarity of the supply voltage.  
Tri-color - The indicator has red and green LEDs, when both connected yellow is produced.

### SUPER BRIGHT LED INTENSITY

LED COMPONENT SPECIFICATIONS			
	Prominent and Recessed	Flush	Forward Voltage
HE Red	17,000 mcd	2000 mcd	2.2 V
Green	11,000 mcd	680 mcd	3.5 V
Yellow	4,000 mcd	350 mcd	2.3 V
Blue	2,500 mcd	250 mcd	3.3 V
White	4,400 mcd	250 mcd	3.3 V
Orange	2,800 mcd	300 mcd	2.1 V

### HYPER BRIGHT LED INTENSITY

LED COMPONENT SPECIFICATIONS			
	Prominent and Recessed	Flush	Forward Voltage
HE Red	2,800 mcd	800 mcd	2.0 V
Green	2,200 mcd	250 mcd	3.2 V
Yellow	1,300 mcd	250 mcd	2.0 V
Orange	850 mcd	200 mcd	2.1 V

### RGB LED INTENSITY

ITEM	SYMBOL	CONDITION	TYP.
DC Forward Voltage	$V_F(R)$	IF=20 mA	2.1
	$V_F(B/G)$	IF=20 mA	2.1
Luminous Intensity	$I_v(\text{Red})$		220 mdc
	$I_v(\text{Green})$		500 mdc
	$I_v(\text{Blue})$		100 mdc

Voltage	Operating Voltage	Operating Current
	(Min to Max)	(Typical All Types)
02 (No Resistor)	1.8 to 3.3 VDC	20 mA max*
6 VDC	5.4 to 6.6 VDC	20 mA
12 VDC	10.8 to 13.2 VDC	20 mA
24 VDC	21.6 to 26.4 VDC	20 mA
28 VDC	25.2 to 30.8 VDC	20 mA
110 VAC	99 to 121 VAC	6 mA
220 VAC	207 to 235 VAC	3 mA

\* Customer to supply resistor for desired operating current.

### ADDITIONAL INFORMATION ON LED COMPONENTS

- Bi-color leds, by connecting the gold faston (+) one color is produced, by reversing the supply voltage another color is produced – bi-colors are available up to 28 VDC
- The tri-color led has red and green leds when both are connected yellow is produced.
- The operating voltage must not be exceeded by more than 10% as this will result in reduced life expectancy
- Luminous intensity is measured at 20 mA on a discrete led unless otherwise stated.
- Luminous intensities and color shades of white LEDs may vary within a batch.
- Luminous intensity will be reduced with lower operating current.



## CONNECTIONS

### REAR EPOXY WIRES FOR RGB OPTION

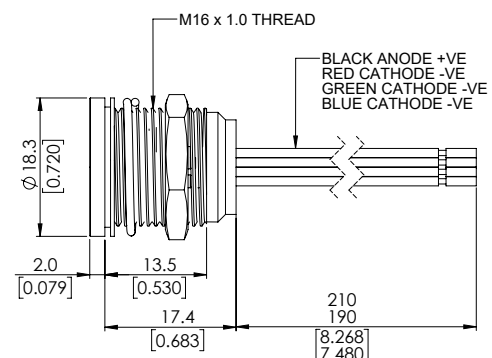

# Q16 series

Ø16 mm panel mount LED indicators



## BUILD YOUR PART NUMBER

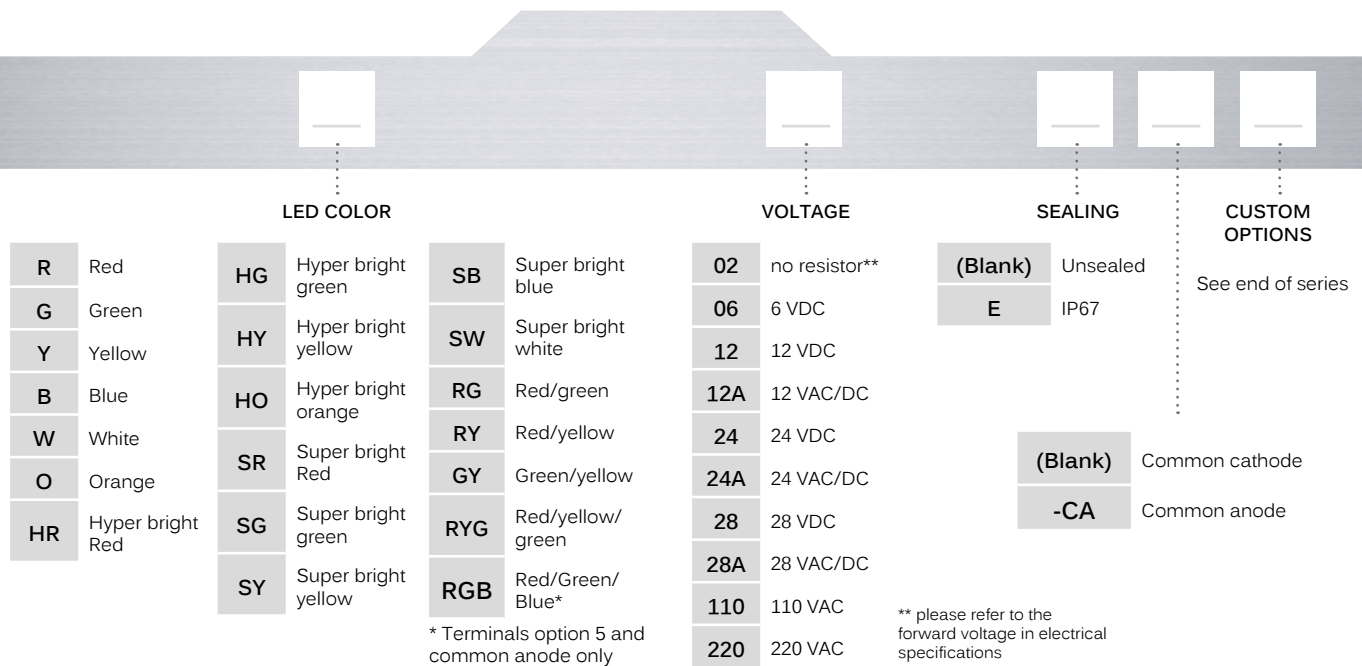
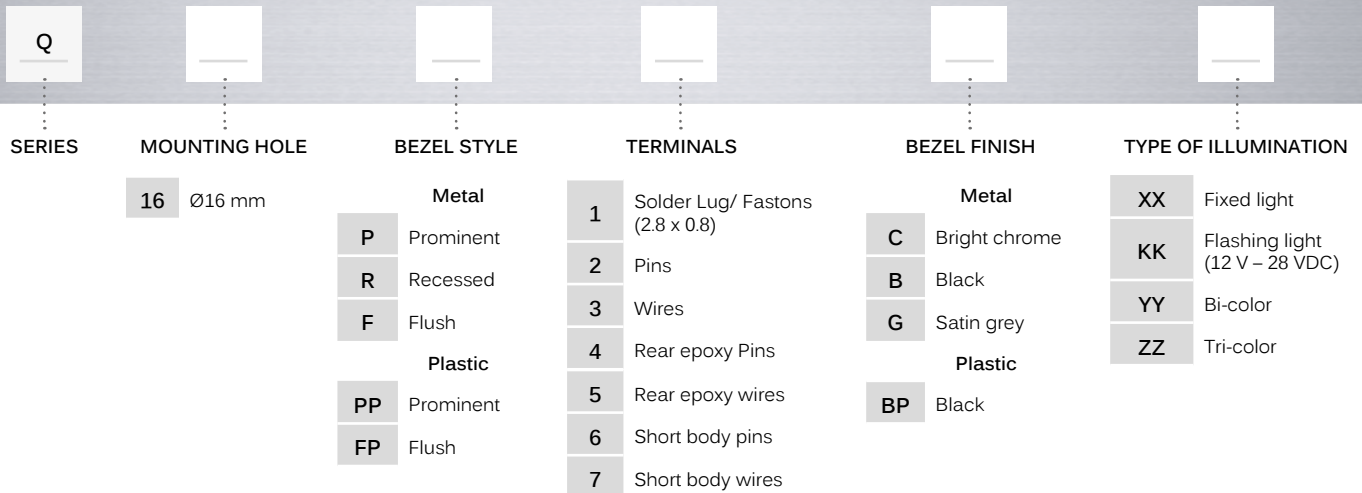

## ABOUT THIS SERIES

- Notice:** please note that not all combinations of above numbers are available.
- Gold faston terminal denotes anode (+), silver terminal denotes cathode (-)
  - Standard wire length is 200 mm, 22 AWG UL1007, red wire denotes anode (+), black wire denotes cathode (-) for other wire lengths consult APEM
  - Take care when soldering to the faston terminals (recommended solder temperature 300 °C - 3 sec)
  - Short body pins and wires are only available up to 28 VDC
  - Standard tri-color faston terminals are two anodes (+) and one cathode (-)
  - Tri-color wires are one red (+) and one green (+) anode and one black (-) cathode
  - Tri-color pins are center (-) cathode, shortest (+) anode pin green, longest (+) anode pin red
  - We recommend using hyperbright or superbright leds for use at 110 VAC and 220 VAC
  - For leds with alternative voltages and for multi-voltage options please consult APEM

# Q16 series

Ø16 mm panel mount LED indicators

## PROMINENT BEZEL



## WIRES

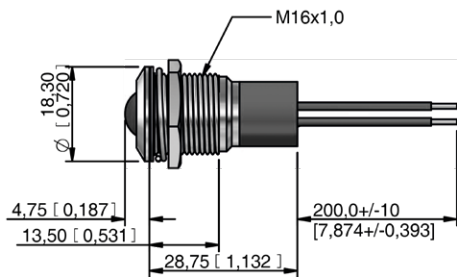

## REAR EPOXY WIRES

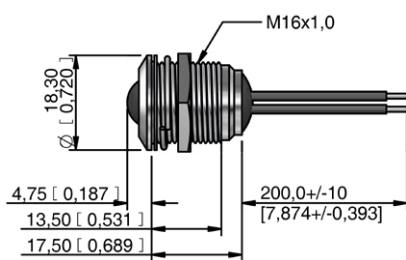

## SHORT BODY WIRES

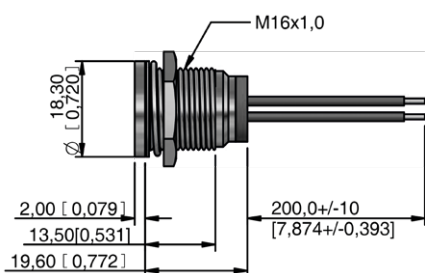

## SOLDER LUG/FASTON

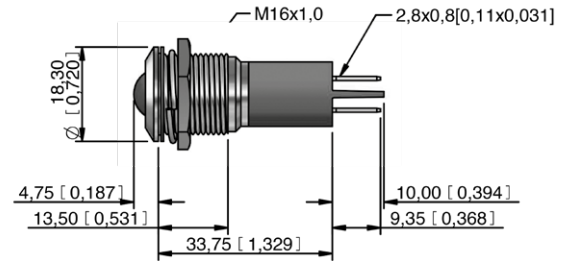

## PINS

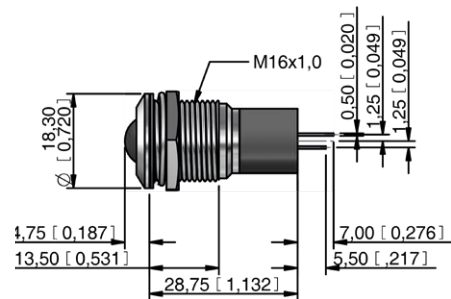

## REAR EPOXY PINS

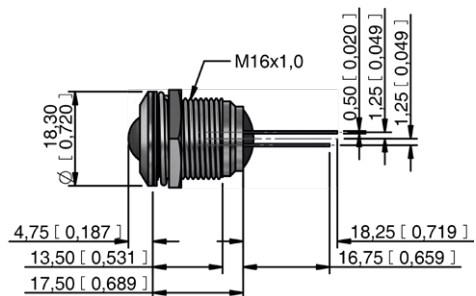

## SHORT BODY PINS

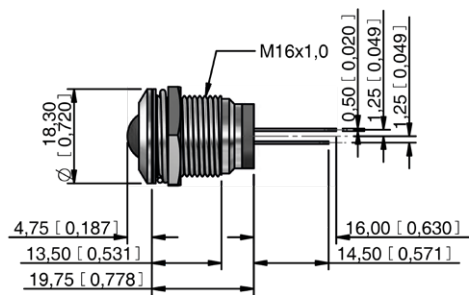

# Q16 series

Ø16 mm panel mount LED indicators

## FLUSH BEZEL



## WIRES

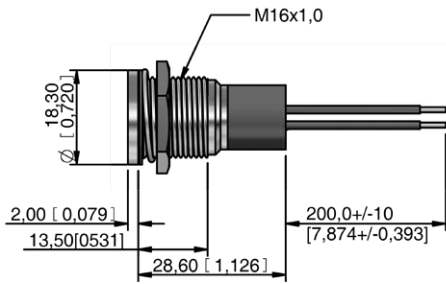

## REAR EPOXY WIRES

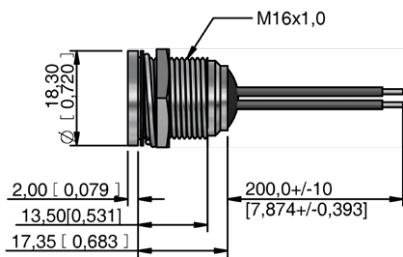

## SHORT BODY WIRES

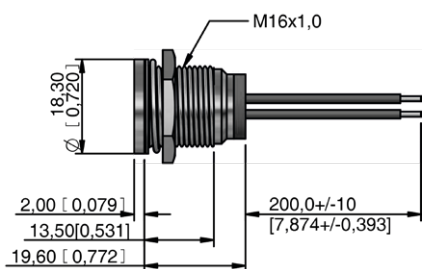

## SOLDER LUG/FASTON

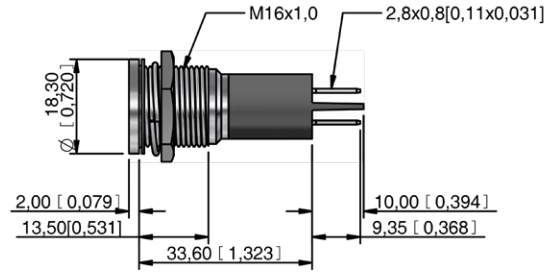

## PINS

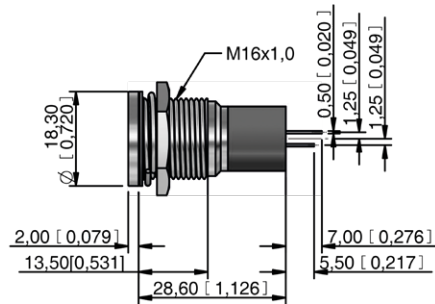

## REAR EPOXY PINS

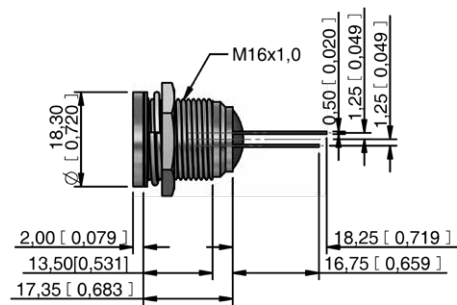

## SHORT BODY PINS

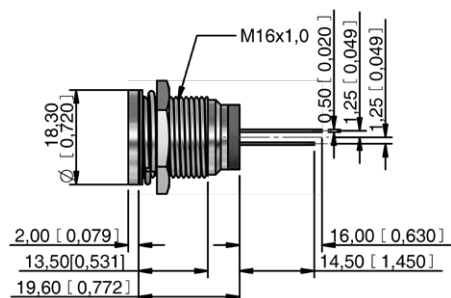

# Q16 series

Ø16 mm panel mount LED indicators

## RECESSED BEZEL



## WIRES

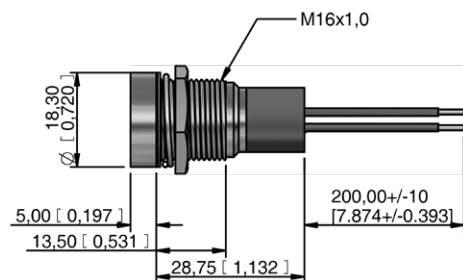

## REAR EPOXY WIRES

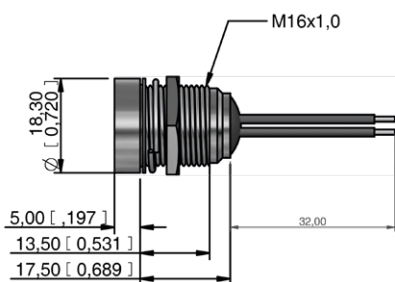

## SHORT BODY WIRES

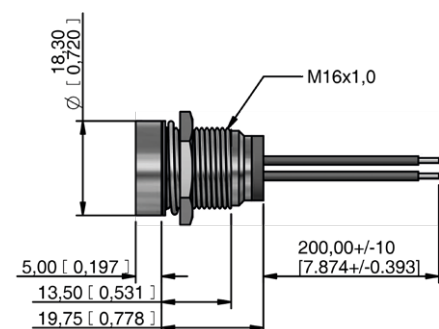

## SOLDER LUG/FASTON

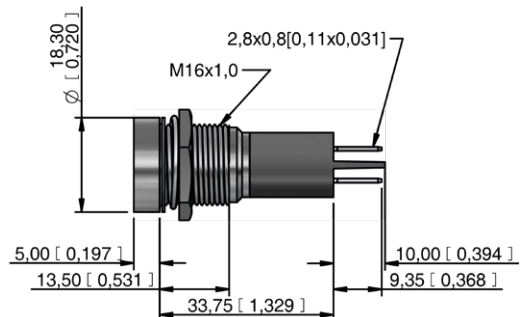

## PINS

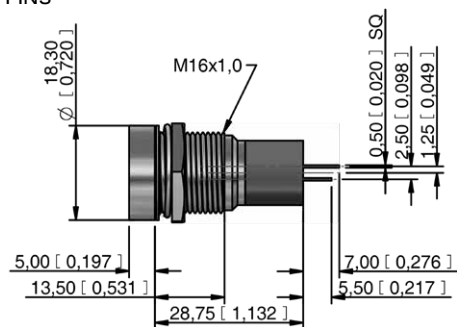

## REAR EPOXY PINS

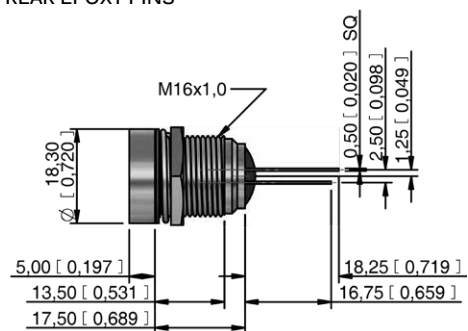



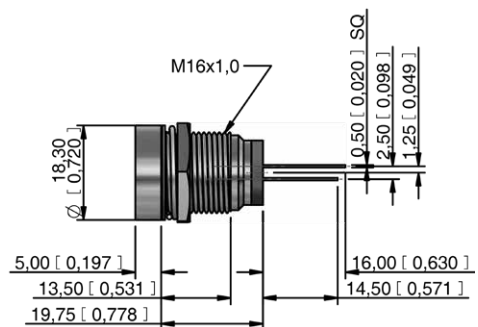





















## SHORT BODY PINS



## CUSTOM ENGRAVING

Some common codes are listed above, for your custom requirements please contact APEM.  
Unless specified standard engraving with white infill will be supplied.  
Suffix the part number with legend code :

						
High beam -0AJ	Low beam -097	Rear fog -027	Front fog -026	Windscreen wiper -021	Windscreen washer -022	Ventilator fan -023
						
Turn Signal -0AH	Side lights -098	Horn -041	Hazard warning -013	Heating -018	Brake test -0BU	Arrow -0K6
						
Battery -0AG	Oil can -0GP	Windscreen heating -020	ABS -086	Engine coil -0EL	Seat belt -0SB	USB connection -0UB
						
Steam -0ST	ECU -0EU	Side step -0AD	Air con -012	Engine -040	Boot/Trunk Release -0BR	



# Q16 series

Ø16 mm panel mount LED indicators



## SECRET UNTIL LIT POLYCARBONATE INSERTS

Some common codes are listed above, for your custom requirements please contact APEM. Please note Secret until lit inserts only available with flush metal bezel (Option F)  
Suffix the part number with legend code :



## CABLE LENGTH AND CONNECTOR



For custom cable length and connectors contact APEM.