

# Remote Type Pressure Sensors/Pressure Sensor Controllers

## PSE Series

Compact Pneumatic Pressure Sensor **PSE530** ▶P.134



The image shows two views of the PSE530 sensor: a side view of the cylindrical metal body with a cable, and a front view of the sensor head with a pressure port and a cable connector.

Compact Pneumatic Pressure Sensor **PSE540** ▶P.137



The image displays several variants of the PSE540 sensor, including different cable lengths and connector types, all featuring a compact cylindrical design.

Low Differential Pressure Sensor **PSE550** ▶P.140



The image shows the PSE550 sensor, which has a rectangular white plastic housing with a cable and a small pressure port on top.

Pressure Sensor for General Fluids **PSE560** ▶P.143



The image shows the PSE560 sensor, a cylindrical metal body with a threaded pressure port and a cable connector.

Pressure Sensor for General Fluids **PSE570** ▶P.146



The image shows the PSE570 sensor, similar to the PSE560 but with a different cable connector design.

Multi-Channel Digital Pressure Sensor Controller **PSE200** ▶P.149



The image shows the PSE200 controller with a digital display showing '-50.7' and '2 CH'. It has buttons for 'SET' and 'CH' and is labeled 'OUT1' and 'OUT2'.

2-Color Display Digital Pressure Sensor Controller **PSE300** ▶P.155



The image shows the PSE300 controller with a digital display showing '-94.0'. It has buttons for 'SET' and 'OUT1'/'OUT2' and is labeled 'OUT1' and 'OUT2'.







**PSE200** DIN rail/Terminal block type



The image shows the PSE200 controller mounted on a DIN rail with terminal blocks for wiring.

- ZSE20 ISE20
- ZSE30 ISE30
- ZSE40 ISE40
- ZSE10 ISE10
- ISE70
- ZSE80 ISE80
- PS
- ISA3
- ISA2
- ISE35
- PSE**
- IS
- ISG
- ZSM1

# PSE Series Variations

Model	Pressure Sensors					Controllers	
	PSE530  P.134	PSE540  P.137	PSE550  P.140	PSE560  P.143	PSE570  P.146	PSE200  P.149	PSE300  P.155

Basic Specifications	Fluid	Air			General fluids		
	Rated pressure range (Minimum display)						
	Repeatability	±1 % (F.S.)	±0.2 % (F.S.)	±0.3 % (F.S.)	±0.2 % (F.S.)	±0.2% (F.S.) PSE570/573/574 ±0.5% (F.S.) PSE575/576/577	±0.1 % (F.S.)
	Voltage	12 to 24 VDC					
	No. of outputs for switch					5 outputs	2 outputs
	Analog output	1 to 5 V		1 to 5 V 4 to 20 mA			1 to 5 V 4 to 20 mA
	Operating temp.	0 to 50°C			-10 to 60°C		0 to 50°C

Functions	Digital display				1-color		2-color	
	Enclosure	IP40			IP65		Front face IP65 Others IP40	IP40
	Wiring	Connector	Grommet		Connector	Connector		
	Major setting function						Keylock, Peak/Bottom values holding, Auto-preset, Auto-shift, Display calibration, Anti-chattering	

Others	Connection threads	M reducer	M R, NPT reducer	Resin piping	R, NPT, Rc URJ, TSJ*	R		
	Int'l standards	CE	CE, UL, CSA			CE	CE	CE, UL, CSA
	Wiring	e-con	●	●	●	●	●	●
		Flexible cable		●	●			●
	Mounting	Direct	●	●	●	●		●
		With bracket		●				●
		Panel mount					●	●
DIN rail							●	

\* URJ: Face seal fitting, TSJ: Compression fitting

Pressure Sensors/*PSE5* Series

		PSE53	PSE54	PSE55	PSE56	PSE57
Vacuum	-101 kPa to 0	PSE531	PSE541	—	PSE561	—
Compound pressure	-100 kPa to 100 kPa	PSE533	PSE543	—	PSE563	PSE573
Positive pressure	0 to 100 kPa	PSE532	—	—	—	—
	0 to 500 kPa	—	—	—	PSE564	PSE574
	0 to 1 MPa	PSE530	PSE540	—	PSE560	PSE570
	0 to 2 MPa	—	—	—	—	PSE575
	0 to 5 MPa	—	—	—	—	PSE576
Low differential pressure	0 to 10 MPa	—	—	—	—	PSE577
	0 to 2 kPa	—	—	PSE550	—	—

Pressure Sensor Controllers/*PSE200/300* Series

PSE200	PSE300	Input/Output specifications
		<ul style="list-style-type: none"> <li>• NPN 2 outputs + 1-5 V output</li> <li>• NPN 2 outputs + 4-20 mA output</li> <li>• NPN 2 outputs + auto-shift input</li> <li>• PNP 2 outputs + 1-5 V output</li> <li>• PNP 2 outputs + 4-20 mA output</li> <li>• PNP 2 outputs + auto-shift input</li> </ul>
<b>Input/Output specifications</b> <ul style="list-style-type: none"> <li>• NPN 5 outputs + auto-shift input</li> <li>• PNP 5 outputs + auto-shift input</li> </ul>		

Applicable pressure sensor model					Set/Display resolution	
PSE531	PSE541	—	PSE561	—	0.1 kPa	0.1 kPa
PSE533	PSE543	—	PSE563	PSE573	0.1 kPa	0.2 kPa
PSE532	—	—	—	—	0.1 kPa	0.1 kPa
—	—	—	PSE564	PSE574	—	1 kPa
PSE530	PSE540	—	PSE560	PSE570	0.001 MPa	0.001 MPa
—	—	PSE550	—	—	—	0.01 kPa

**Main Functions** (For details, refer to pages 162 to 164.)

<b>Keylock</b>	Locks the keys from functioning.
<b>Peak/Bottom values holding</b>	Displays the maximum and minimum values being set and can keep those values on the display.
<b>Auto-preset</b>	Able to set the pressure automatically. In the case of suction verification, it memorizes the pressure when adsorbed and released. By repeating several times, the optimum values are calculated automatically.
<b>Auto-shift</b>	Stable switch output is available even though the supply pressure may fluctuate. Automatically corrects the set value in accordance with the fluctuations in the supply pressure.
<b>Display calibration</b>	Able to adjust the displayed value (±5%) and justify distribution of the values displayed on respective pressure switch.
<b>Anti-chattering</b>	Prevents malfunction due to sharp pressure fluctuations. The detection of momentary pressure fluctuation as abnormal pressure can be prevented by changing the setting of the response time.

ZSE20  
ISE20  
ZSE30  
ISE30  
ZSE40  
ISE40  
ZSE10  
ISE10  
ISE70  
ZSE80  
ISE80  
PS  
ISA3  
ISA2  
ISE35  
PSE  
IS  
ISG  
ZSM1

# Compact Pneumatic Pressure Sensor

## PSE530 Series



RoHS

Series	Rated pressure range				
	-100 kPa	0	100 kPa	500 kPa	1 MPa
PSE530		0	1 MPa		
PSE531	-101 kPa	0			
PSE532		0	101 kPa		
PSE533	-101 kPa		101 kPa		

### Connector type

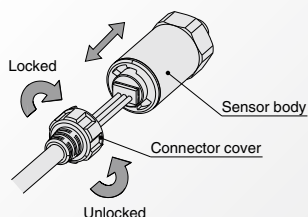

### Application example

#### Leak test of radiator PSE532 + PSE300 Series

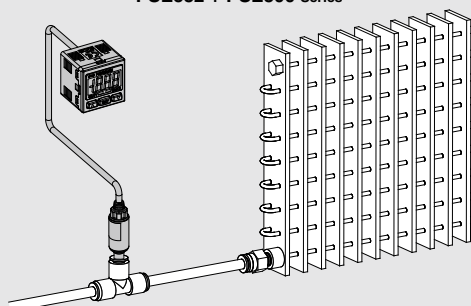

Low pressure sensor (PSE532-□) is used to detect minute differentiations. Auto-shift function reduces influence of fluctuations in the supply pressure.

*Applications*

# Pressure Sensor **PSE530 Series**



## How to Order

PSE53 **0** - **M5** -   

### Sensor range

<b>0</b>	Positive pressure [0 to 1 MPa]
<b>1</b>	Vacuum [0 to -101 kPa]
<b>2</b>	Low pressure [0 to 101 kPa]
<b>3</b>	Compound pressure [-101 to 101 kPa]

### Port size

<b>M5</b>	M5 x 0.8
<b>R06</b>	ø6 reducer
<b>R07</b>	1/4 inch reducer

### Option

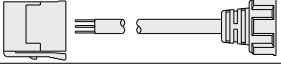
<b>Nil</b>	None
<b>L</b>	Sensor cable (3 m) 
<b>C2L</b>	Connector for pressure sensor controller (1 pc.) + Sensor cable (3 m) 

Note) The connector is not attached to the cable, but is included with the shipment.

## Option/Part No.

When only optional parts are required, order using the part numbers listed below.

Description	Part no.	Note
Connector for pressure sensor controller	ZS-28-C	1 pc. per set
Sensor cable	ZS-26-F	Cable length: 3 m
Connector for pressure sensor controller + Sensor cable	ZS-26-J	Cable length: 3 m The connector is not attached to the cable at the time of shipment.

Refer to pages 11 and 12 for Pressure Switch Precautions. For details about the Specific Product Precautions, refer to the Operation Manual on the SMC website, <http://www.smcworld.com> Click [here](#) for details.

## Specifications

Model	PSE530 (Positive pressure)	PSE531 (Vacuum)	PSE532 (Low pressure)	PSE533 (Compound pressure)
<b>Rated pressure range</b>	0 to 1 MPa	0 to -101 kPa	0 to 101 kPa	-101 to 101 kPa
<b>Extension analog output range</b>	-0.1 to 0 MPa	10.1 to 0 kPa	-10.1 to 0 kPa	—
<b>Proof pressure</b>	1.5 MPa		500 kPa	
<b>Applicable fluid</b>	Air/Non-corrosive gas/Non-flammable gas			
<b>Power supply voltage</b>	12 to 24 VDC ±10%, Ripple (p-p) 10% or less (with reverse connection protection)			
<b>Current consumption</b>	15 mA or less (with no load)			
<b>Output specifications</b>	Analog output 1 to 5 V (within rated pressure range), 0.6 to 1 V (within extension analog output range), Output impedance: Approx. 1 kΩ			
<b>Accuracy (Ambient temperature at 25°C)</b>	±2% F.S. (within rated pressure range), ±5% F.S. (within extension analog output range)			
<b>Linearity</b>	±1% F.S.			
<b>Repeatability</b>	±1% F.S.			
<b>Power supply voltage effect</b>	±1% F.S. based on the analog output at 18 V ranging from 12 to 24 VDC			
<b>Environment</b>	<b>Enclosure</b>	IP40		
	<b>Temperature range</b>	Operating: 0 to 50°C; Stored: -10 to 70°C (No freezing or condensation)		
	<b>Withstand voltage</b>	1000 VAC (in 50/60 Hz) for 1 minute between terminals and housing		
	<b>Insulation resistance</b>	5 MΩ or more (500 VDC measured via megohmmeter) between terminals and housing		
<b>Temperature characteristics</b>	±2% F.S. (25°C reference)			
<b>Sensor cable/Option</b>	Halogen-free heavy-duty cable, 3 cores, ø2.7, 3 m, Conductor area: 0.15 mm <sup>2</sup> , Insulator O.D.: 0.8 mm			
<b>Standards</b>	CE, RoHS			

## Piping Specifications

Model	M5	R06	R07
<b>Port size</b>	M5 x 0.8 male thread	ø6 reducer type	1/4 inch reducer type
<b>Materials of parts in contact with fluid</b>	Pressure sensor: Silicon, O-ring: NBR		
	Body: Stainless steel 304	Body: PBT	
<b>Weight</b>	With sensor cable (3 m)	41 g	38 g
	Without sensor cable	7 g	3.8 g

ZSE20  
ISE20  
ZSE30  
ISE30  
ZSE40  
ISE40  
ZSE10  
ISE10  
ISE70  
ZSE80  
ISE80  
PS  
ISA3  
ISA2  
ISE35  
PSE  
IS  
ISG  
ZSM1

# PSE530 Series

## Internal Circuit and Wiring Example

### PSE53□

Voltage output type  
1 to 5 V  
Output impedance  
Approx. 1 k $\Omega$

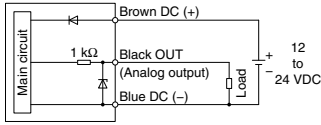

## Analog Output

1 to 5 VDC

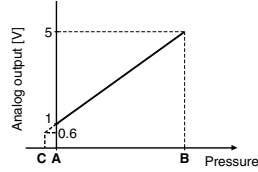

Range	Rated pressure range	A	B	C
For vacuum	0 to -101 kPa	0	-101 kPa	10.1 kPa
For compound pressure	-101 kPa to 101 kPa	-101 kPa	101 kPa	—
For low pressure	0 to 101 kPa	0	101 kPa	-10.1 kPa
For positive pressure	0 to 1 MPa	0	1 MPa	-0.1 MPa

## Dimensions

### PSE53□-M5

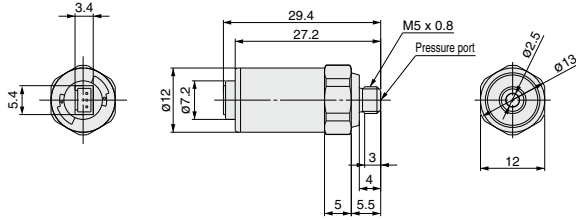

### PSE53□-R06 R07

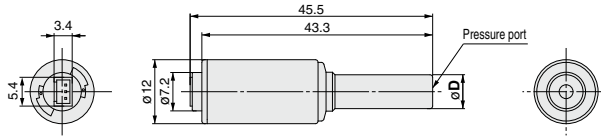

Model	Applicable fitting size (D)
PSE53□-R06	6
PSE53□-R07	1/4"

### With sensor cable

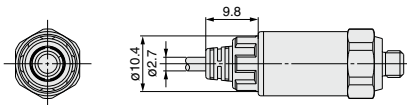

# Compact Pneumatic Pressure Sensor

## PSE540 Series

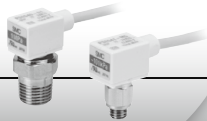

Series	Rated pressure range				
	-100 kPa	0	100 kPa	500 kPa	1 MPa
PSE540		0	1 MPa		
PSE541	-101 kPa	0			
PSE543	-100 kPa		100 kPa		

- Weight: 2.9 g
- Head size: 9.6 x 20.8 x 18 mm

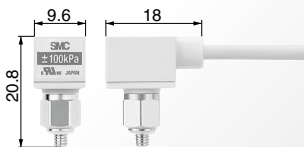

For PSE54□-M3

### Application examples

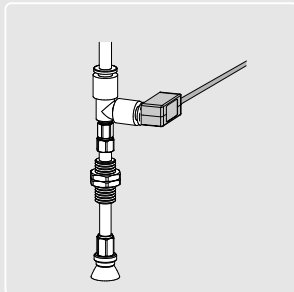

**Pads can be directly mounted.**

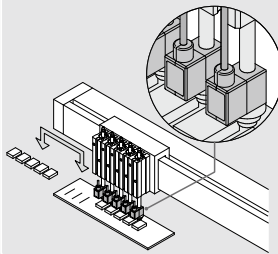

**Manifolding is possible.**

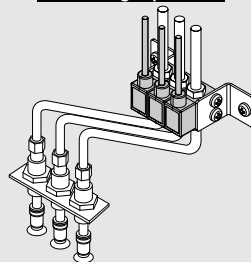

*Applications*

ZSE20  
ISE20

ZSE30  
ISE30

ZSE40  
ISE40

ZSE10  
ISE10

ISE70

ZSE80  
ISE80

PS

ISA3

ISA2

ISE35

**PSE**

IS

ISG

ZSM1

# Compact Pneumatic Pressure Sensor

## PSE540 Series



### How to Order



Sensor range	
0	Positive pressure [0 to 1 MPa]
1	Negative pressure [0 to -101 kPa]
3	Compound pressure [-100 to 100 kPa]

Accuracy	
Nil	±2% F.S.
A	±1% F.S.









#### Option (Connector)

Option (Connector)	
Nil	None
C2	Connector for pressure sensor controller (1 pc.) 

Note) The connector is not attached to the cable, but is included with the shipment.

PSE54 **1** - **M3** -

#### Port size

M3	M3 x 0.5		IM5	M5 female thread, through type	
M5	M5 x 0.8		IM5H	M5 female thread, through type (with mounting hole)	
01	R1/8 (with M5 female thread)				
N01	NPT1/8 (with M5 female thread)				
R04	ø4 reducer				
R06	ø6 reducer				

### Option/Part No.

Description	Part no.	Note
Connector for pressure sensor controller	ZS-28-C	1 pc.

### Specifications

Refer to pages 11 and 12 for Pressure Switch Precautions. For details about the Specific Product Precautions, refer to the Operation Manual on the SMC website, <http://www.smworld.com> Click [here](#) for details.

Model		PSE540	PSE541	PSE543
Rated pressure range		0 to 1 MPa	0 to -101 kPa	-100 to 100 kPa
Extension analog output range		-0.1 to 0 MPa	10.1 to 0 kPa	—
Proof pressure		1.5 MPa	500 kPa	
Applicable fluid		Air/Non-corrosive gas/Non-flammable gas		
Power supply voltage		12 to 24 VDC ±10%, Ripple (p-p) 10% or less (with reverse connection protection)		
Current consumption		15 mA or less		
Output specifications		Analog output 1 to 5 V (within rated pressure range), 0.6 to 1 V (within extension analog output range), Output impedance: Approx. 1 kΩ		
Accuracy (Ambient temperature at 25°C)		PSE54□: ±2% F.S. (within rated pressure range), ±5% F.S. (within extension analog output range) PSE54□A: ±1% F.S. (within rated pressure range), ±3% F.S. (within extension analog output range)		
Linearity		±0.7% F.S. or less	±0.4% F.S.	
Repeatability		±0.2% F.S.		
Power supply voltage effect		±0.8% F.S.		
Environment	Enclosure	IP40		
	Operating temperature range	Operating: 0 to 50°C, Stored: -20 to 70°C (No freezing or condensation)		
	Operating humidity range	Operating/Stored: 35 to 85% RH (No condensation)		
	Withstand voltage	1000 VAC (in 50/60 Hz) for 1 minute between terminals and housing		
Insulation resistance		50 MΩ or more (500 VDC measured via megohmmeter) between terminals and housing		
Temperature characteristics		±2% F.S. (25°C reference)		
Sensor cable		Oilproof heavy-duty vinyl cable (ellipse), 3 cores, 2.7 x 3.2, 3 m, Conductor area: 0.15 mm <sup>2</sup> , Insulator O.D.: 0.9 mm		
Standards		CE, UL/CSA (E216656), RoHS		

### Piping Specifications

Model		M3	M5	01	N01	R04	R06	IM5	IM5H
Port size		M3 x 0.5	M5 x 0.8	R1/8 M5 x 0.8	NPT1/8 M5 x 0.8	ø4 reducer	ø6 reducer	M5 female thread, through type	M5 female thread, through type (with mounting hole)
Material	Case	Resin case: PBT Fitting: Stainless steel 303		Resin case: PBT Fitting: C3604BD		PBT		Resin case: PBT Fitting: A6063S-T5	
	Pressure sensing section	Pressure sensor: Silicon, O-ring: NBR							
Weight	With sensor cable	42.4 g	42.7 g	49.3 g	41.4 g	41.6 g	43.3 g	44.1 g	
	Without sensor cable	2.9 g	3.2 g	9.8 g	1.9 g	2.1 g	3.8 g	4.6 g	



## Internal Circuit and Wiring Example

### PSE54□

Voltage output type  
1 to 5 V  
Output impedance  
Approx. 1 k $\Omega$

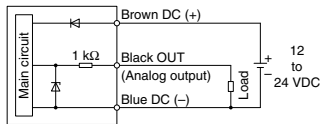

## Analog Output

1 to 5 VDC

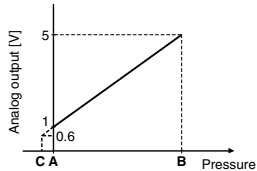

Range	Rated pressure range	A	B	C
For vacuum	0 to -101 kPa	0	-101 kPa	10.1 kPa
For compound pressure	-100 kPa to 100 kPa	-100 kPa	100 kPa	—
For positive pressure	0 to 1 MPa	0	1 MPa	-0.1 MPa

## Dimensions

### PSE54□-M3 M5

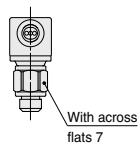
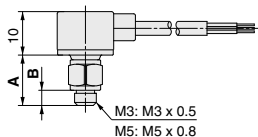

	PSE54□-M3	PSE54□-M5
A	10.8	11.5
B	3	3.5

### PSE54□-R04 R06

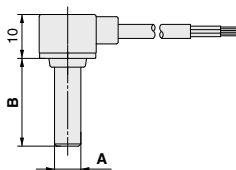

	PSE54□-R04	PSE54□-R06
A	10	11.5
B	18	20

## Common Dimensions

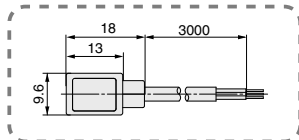

### PSE54□-IM5

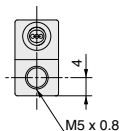
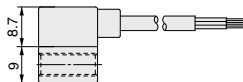

### PSE54□-01 N01

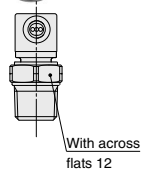
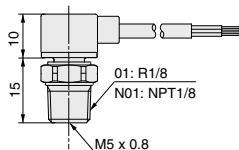

### PSE54□-IM5H

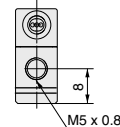
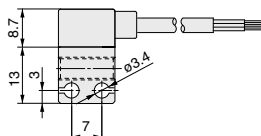

ZSE20  
ISE20  
ZSE30  
ISE30  
ZSE40  
ISE40

ZSE10  
ISE10

ISE70

ZSE80  
ISE80

PS

ISA3

ISA2

ISE35

**PSE**

IS

ISG

ZSM1



# Low Differential Pressure Sensor

## PSE550 Series



Series	Rated pressure range		
	0	1 kPa	2 kPa
PSE550	0	2 kPa	

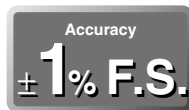
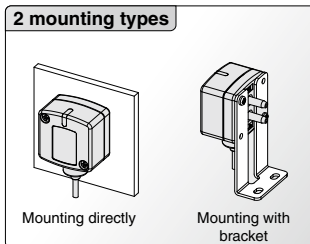
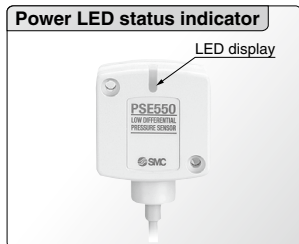

### Application examples

**Flow control**  
PSE550 Series

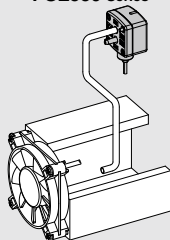

Can control air flow by monitoring the flow rate inside the duct.

**Filter clogging monitoring**  
PSE550 Series

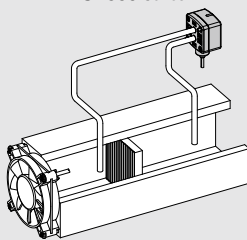

Can control filtration and replacement periods by monitoring the clogging of the filter.

**Liquid level detection**  
PSE550 Series

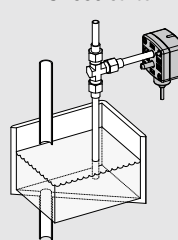

Can detect the liquid level through changes in the purge pressure.

### Applications

# Low Differential Pressure Sensor

# PSE550 Series



## How to Order

PSE550 - [ ] - [ ] - [ ]

### Output specifications

<b>Nil</b>	Voltage output type 1 to 5 V
<b>28</b>	Current output type 4 to 20 mA

### Option 2 (Connector)

<b>Nil</b>	None
<b>C2</b>	Connector for pressure sensor controller (1 pc.)



Note 1) Not applicable to the PSE200 series.

Note 2) The connector is not attached to the cable, but is included with the shipment.

### Option 1 (Bracket)

<b>Nil</b>	None
<b>A</b>	Bracket

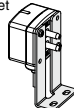

Note) The bracket is not attached to the product, but is included with the shipment.

## Option/Part No.

Description	Part no.	Note
Bracket	ZS-30-A	With M3 x 5L (2 pcs.)
Connector for pressure sensor controller	ZS-28-C	1 pc.

Refer to pages 11 and 12 for Pressure Switch Precautions. For details about the Specific Product Precautions, refer to the Operation Manual on the SMC website, <http://www.smcworld.com> Click [here](#) for details.

## Specifications

Model	PSE550	PSE550-28
Rated differential pressure range	0 to 2 kPa	
Operating pressure range	-50 to 50 kPa <sup>Note)</sup>	
Extension analog output range	-0.2 to 0 kPa	—
Proof pressure	65 kPa	
Applicable fluid	Air/Non-corrosive gas/Non-flammable gas	
Power supply voltage	12 to 24 VDC ±10%, Ripple (p-p) 10% or less (with reverse connection protection)	
Current consumption	15 mA or less	—
Output specifications	Analog output: 1 to 5 VDC (within rated differential pressure range) 0.6 to 1 VDC (within extension analog output range) Output impedance: Approx. 1 kΩ	Analog output: 4 to 20 mA DC (within rated differential pressure range) Maximum load impedance: 500 Ω or less (at 24 VDC) 100 Ω or less (at 12 VDC)
Accuracy (Operating temperature at 25°C)	±1% F.S. (within rated differential pressure range), ±3% F.S. (within extension analog output range)	
Linearity	±0.5% F.S.	
Repeatability	±0.3% F.S.	
Indicator light	Orange light is turned on. (When energized)	
Environment	Enclosure	IP40
	Operating temperature range	Operating: 0 to 50°C, Stored: -20 to 70°C (No freezing or condensation)
	Operating humidity range	Operating/Stored: 35 to 85% RH (No condensation)
	Withstand voltage	1000 VAC (in 50/60 Hz) for 1 minute between terminals and housing
Insulation resistance	50 MΩ or more (500 VDC measured via megohmmeter) between terminals and housing	
Temperature characteristics	±3% F.S. (25°C reference)	
Port size	ø4.8 (ø4.4 in the end) resin piping (Applicable to I.D. ø4 air tubing)	
Materials of parts in contact with fluid	Resin pipe: Nylon, Piston area of sensor: Silicon	
Sensor cable	Oilproof heavy-duty vinyl cable (ellipse), 3 cores, 2.7 x 3.2, 3 m Conductor area: 0.15 mm <sup>2</sup> , Insulator O.D.: 0.9 mm	Oilproof heavy-duty vinyl cable (ellipse), 2 cores, 2.7 x 3.2, 3 m Conductor area: 0.15 mm <sup>2</sup> , Insulator O.D.: 0.9 mm
Weight	With sensor cable	75 g
	Without sensor cable	35 g
Standards	CE, UL/CSA (E216656), RoHS	

Note) Can detect differential pressure from 0 to 2 kPa within the range of -50 to 50 kPa.

ZSE20  
ISE20  
ZSE30  
ISE30  
ZSE40  
ISE40  
ZSE10  
ISE10  
ISE70  
ZSE80  
ISE80  
PS  
ISA3  
ISA2  
ISE35  
PSE  
IS  
ISG  
ZSM1

# PSE550 Series

## Internal Circuit and Wiring Example

### PSE550

Voltage output type  
1 to 5 V  
Output impedance  
Approx. 1 k $\Omega$

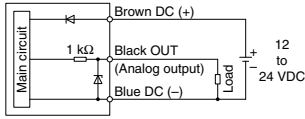

### PSE550-28

Current output type  
4 to 20 mA  
Allowable load impedance  
500  $\Omega$  or less (at 24 VDC)  
100  $\Omega$  or less (at 12 VDC)

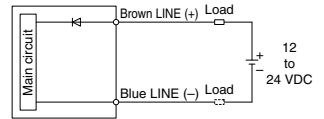

\* Install the load either on the LINE (+) or LINE (-) side.

## Analog Output

### 1 to 5 VDC

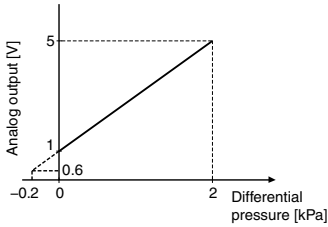

### 4 to 20 mA DC

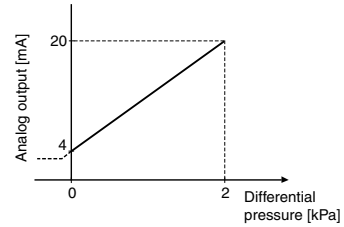

## Dimensions

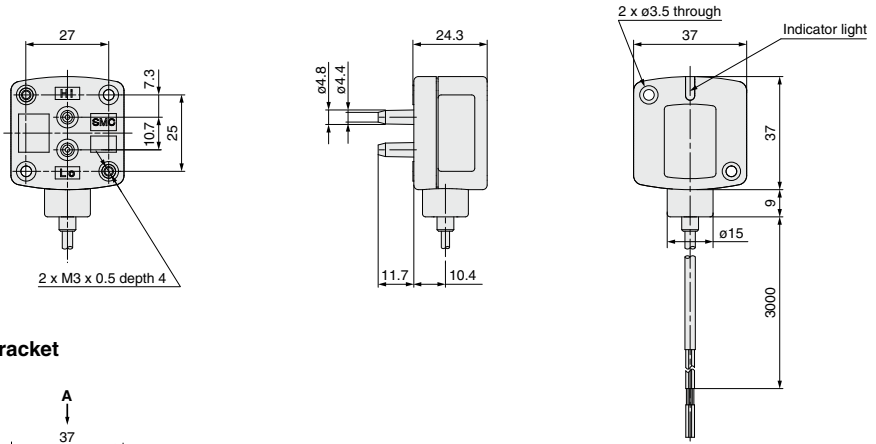

### With bracket

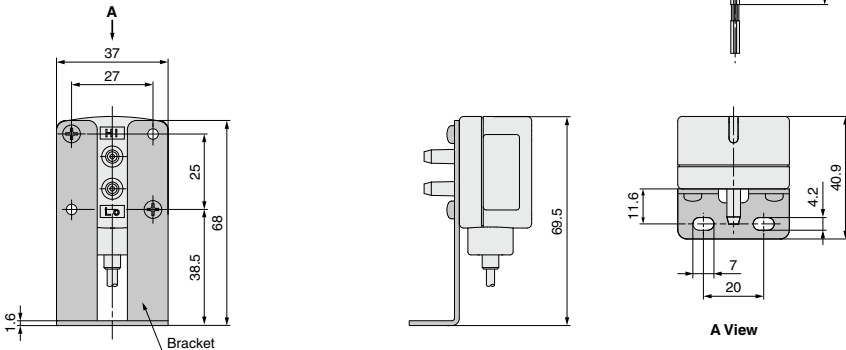



# Pressure Sensor For General Fluids

## PSE560 Series



RoHS

Series	Rated pressure range				
	-100 kPa	0	100 kPa	500 kPa	1 MPa
PSE560		0	1 MPa		
PSE561	-101 kPa	0			
PSE563	-100 kPa		100 kPa		
PSE564		0		500 kPa	

### Applicable fluids example

- Argon
- Air-containing drainage
- Refrigerant
- Nitrogen
- Hydraulic oil
- Silicone oil
- Water
- Carbon dioxide
- Lubricant
- Fluorocarbon
- Air

Material of parts  
in contact with fluid  
**Stainless steel 316L**

**IP65**

**Copper-free  
Fluorine-free**

**Oil-free**  
(Single diaphragm construction)

### Variations

Port type	Thread type	Special fitting type for semiconductors
Port size	R1/8, R1/4, Rc1/8, NPT1/8, NPT1/4	URJ1/4, TSJ1/4*
Leakage	$1 \times 10^{-5} \text{Pa} \cdot \text{m}^3/\text{s}$	$1 \times 10^{-10} \text{Pa} \cdot \text{m}^3/\text{s}$
Analog output	1 to 5 V voltage output	
	4 to 20 mA current output	

\* For URJ1/4, TSJ1/4, refer to "Glossary of Terms/Technical Information" on pages 182 to 196.

### Application examples

#### Cleaning lines

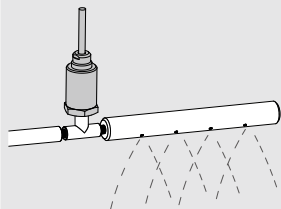

#### Check for working pressure for hydraulic cylinders

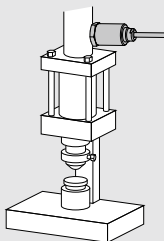

#### Suction verification of workpieces containing moisture

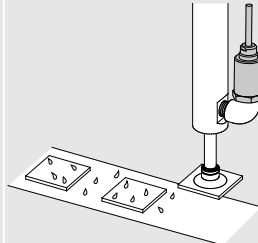

Note: When vacuum is released, take precautions to avoid water collision with inertia force. (An adapter with restrictor (ZS-31-X175) is available to prevent water collision with rush inertia.) (Refer to "NOTE" on the Operation Manual at SMC website for details.)

Applications

ZSE20  
ISE20  
ZSE30  
ISE30  
ZSE40  
ISE40  
ZSE10  
ISE10  
ISE70  
ZSE80  
ISE80  
PS  
ISA3  
ISA2  
ISE35  
PSE  
IS  
ISG  
ZSM1

# Pressure Sensor For General Fluids

# PSE560 Series



## How to Order

### Sensor range

0	Positive pressure [0 to 1 MPa]
1	Vacuum [0 to -101 kPa]
3	Compound pressure [-100 to 100 kPa]
4	Positive pressure [0 to 500 kPa]

PSE56 0-01-

### Port size

01	R1/8 (with M5 female thread)
02	R1/4 (with M5 female thread)
C01	Rc1/8
N01	NPT1/8 (with M5 female thread)
N02	NPT1/4 (with M5 female thread)
A2	URJ1/4 (Face seal fitting)
B2	TSJ1/4 (Compression fitting)

### Output specifications

Nil	Voltage output type 1 to 5 V
28	Current output type 4 to 20 mA

### Option (Connector)

Nil	None
C2	Connector for pressure sensor controller (1 pc.)



Note 1) Current output type cannot be connected to the PSE200 series.  
Note 2) The connector is not attached to the cable, but is included with the shipment.

## Option/Part No.

Description	Part no.	Material	Note
Connector for pressure sensor controller	ZS-28-C	—	1 pc.
Adapter with restrictor Rc1/4	ZS-31-X175	—	1 pc.
Adapter with restrictor NPT1/4	ZS-31-X186	Stainless steel 304	1 pc.
Adapter with restrictor Rc1/8	ZS-31-X188	—	1 pc.
Adapter with restrictor NPT1/8	ZS-31-X189	—	1 pc.
Orifice M5	ZS-48-A	Stainless steel 303	1 pc.

Refer to pages 11 and 12 for Pressure Switch Precautions. For details about the Specific Product Precautions, refer to the Operation Manual on the SMC website, <http://www.smcworld.com> Click [here](#) for details.

## Specifications

Model	PSE560 (Positive pressure)	PSE561 (Vacuum)	PSE563 (Compound pressure)	PSE564 (Positive pressure)
Rated pressure range	0 to 1 MPa	0 to -101 kPa	-100 to 100 kPa	0 to 500 kPa
Extension analog output range	-0.1 to 0 MPa	10.1 to 0 kPa	—	-50 to 0 kPa
Proof pressure	1.5 MPa	500 kPa	500 kPa	750 kPa

Model	PSE56□-□	PSE56□-□-28
Applicable fluid	Liquid or gas that will not corrode or attack stainless steel 316L	
Power supply voltage	12 to 24 VDC ±10%, Ripple (p-p) 10% or less (with reverse connection protection)	
Current consumption	10 mA or less	—
Output specifications	Analog output: 1 to 5 V (within rated pressure range) 0.6 to 1 V (within extension analog output range) Output impedance: Approx. 1 kΩ	Analog output: 4 to 20 mA DC (within rated pressure range) Maximum load impedance: 500 Ω or less (at 24 VDC) 100 Ω or less (at 12 VDC)
Accuracy (Ambient temperature at 25°C)	±1% F.S. (within rated pressure range), ±3% F.S. (within extension analog output range)	
Linearity	±0.5% F.S.	
Repeatability	±0.2% F.S.	
Power supply voltage effect	±0.3% F.S.	
Environment	Enclosure	IP65
	Operating temperature range	Operating: -10 to 60°C, Stored: -20 to 70°C (No freezing or condensation)
	Operating humidity range	Operating/Stored: 35 to 85% RH (No condensation)
	Withstand voltage	250 VAC for 1 minute between terminals and housing
Insulation resistance	50 MΩ or more (50 VDC measured via megohmmeter) between terminals and housing	
Temperature characteristics	±2% F.S. (0 to 50°C; 25°C reference), ±3% F.S. (-10 to 60°C; 25°C reference)	
Sensor cable	PSE56□-□: Oilproof heavy-duty vinyl cable with air tubing, 3 cores, ø5.1, 3 m, Conductor area: 0.2 mm <sup>2</sup> , Insulator O.D.: 1.12 mm PSE56□-□-28: Oilproof heavy-duty vinyl cable with air tubing, 2 cores, ø5.1, 3 m, Conductor area: 0.2 mm <sup>2</sup> , Insulator O.D.: 1.12 mm	
Standards	CE marking (EMC directive/RoHS directive), UL/CSA (E216656)	

## Piping Specifications

Model	01	02	N01	N02	C01	A2	B2	
Port size	R1/8 M5 x 0.8	R1/4 M5 x 0.8	NPT1/8 M5 x 0.8	NPT1/4 M5 x 0.8	Rc1/8	URJ1/4	TSJ1/4	
Material	Case: C3604 + Nickel plating, Piping port/Pressure sensor: Stainless steel 316L							
Weight	With sensor cable	193 g	200 g	194 g	201 g	187 g	203 g	193 g
	Without sensor cable	101 g	108 g	102 g	109 g	95 g	111 g	101 g

## Internal Circuit and Wiring Example

### PSE56□-□

Voltage output type  
1 to 5 V  
Output impedance  
Approx. 1 kΩ

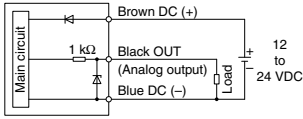

### PSE56□-□-28

Current output type  
4 to 20 mA  
Allowable load impedance  
500 Ω or less (at 24 VDC)  
100 Ω or less (at 12 VDC)

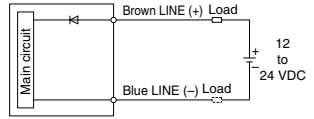

\* Install the load either on the LINE (+) or LINE (-) side.

## Analog Output

1 to 5 VDC

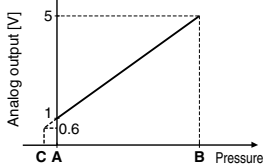

4 to 20 mA DC

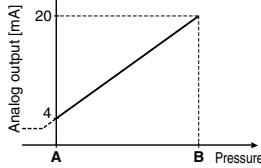

Range	Rated pressure range	A	B	C
For vacuum	0 to -101 kPa	0	-101 kPa	10.1 kPa
For compound pressure	-100 kPa to 100 kPa	-100 kPa	100 kPa	—
For positive pressure	0 to 1 MPa	0	1 MPa	-0.1 MPa
	0 to 500 kPa	0	500 kPa	-50 kPa

## Dimensions

### PSE56□-01, PSE56□-N01 02, PSE56□-N02

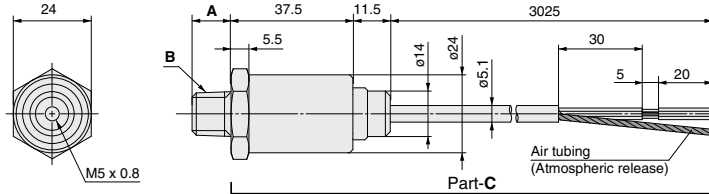

\* The dimensions of part C are common to all PSE56□ models.

Be sure to release the air in the air tubing of the cable to the atmosphere. If the air tubing is restricted, or left in environments where it is exposed to water or oil, it cannot be detected normally.

### PSE56□-C01

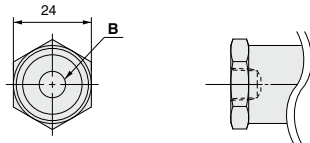

### PSE56□-A2

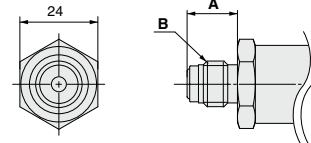

### PSE56□-B2

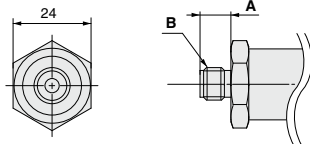

### Adapter with restrictor

#### ZS-31-X□□□

Material:  
Stainless steel 304

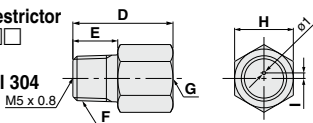

### Orifice ZS-48-A

Material:  
Stainless steel 303

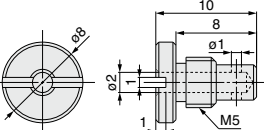

Model	A	B
PSE56□-01	8.2	R1/8
PSE56□-02	12	R1/4
PSE56□-N01	9.2	NPT1/8
PSE56□-N02	12.2	NPT1/4
PSE56□-C01	—	Rc1/8
PSE56□-A2	15.5	URJ1/4
PSE56□-B2	9.5	TSJ1/4

Part no.	D	E	F	G	H	I
ZS-31-X188	20	9	R1/8	Rc1/8	14	1.5
ZS-31-X189	20	9	NPT1/8	NPT1/8	14	1.5
ZS-31-X175	29	13	R1/4	Rc1/4	17	1.6
ZS-31-X186	29	13	NPT1/4	NPT1/4	17	1.6

Note) If it is predicted that the pressure, such as the water hammer or surge pressure fluctuates rapidly, refer to the Precautions stated in the Operation Manual at SMC website (<http://www.smccworld.com>).



# Pressure Sensor For General Fluids

## PSE570 Series



Series	Rated pressure range						
	0	100 kPa	500 kPa	1 MPa	2 MPa	5 MPa	10 MPa
PSE570		0	1 MPa				
PSE573	-100 kPa	100 kPa					
PSE574		0	500 kPa				
PSE575		0	2 MPa				
PSE576		0	5 MPa				
PSE577		0	10 MPa				

### M12 connector



#### Materials of Parts in Contact with Fluid

	PSE570/573/574	PSE575/576/577
Piping port*	C3604 + Nickel plating	
Pressure sensor*	Al <sub>2</sub> O <sub>3</sub> (Alumina 96%)	
Sensor seal	FKM + Grease	FKM

\* Stainless steel 316L is used for the PSE560.  
For details, refer to page 143.

**Withstand  
voltage**

**500 VAC**

<Twice that of the PSE560>

**IP65**

### Application examples

#### Liquid coolant pressure control

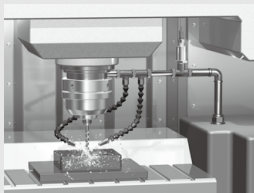

#### PET bottle molding machines

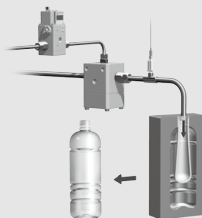

#### Liquid pressure control of gun drills

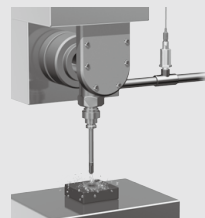

*Applications*



# Pressure Sensor for General Fluids

# PSE570 Series



## How to Order

PSE57 0 - 01 - [ ] - [ ]

### Sensor range

0	Positive pressure [0 to 1 MPa]
3	Compound pressure [-100 to 100 kPa]
4	Positive pressure [0 to 500 kPa]
5	Positive pressure [0 to 2 MPa]
6	Positive pressure [0 to 5 MPa]
7	Positive pressure [0 to 10 MPa]

### Option (Lead wire)

Nil	Lead wire and M12 connector (3 m), Straight	
L	Lead wire and M12 connector (3 m), Right angle	
N	None	

\* See page 164-5 for connection to the PSE300AC.

### Output specification

Nil	Voltage output type 1 to 5 V
2B	Current output type 4 to 20 mA

### Port size

Symbol	Port size	Model					
		PSE570	PSE573	PSE574	PSE575	PSE576	PSE577
01	R1/8 (with M5 female thread)	●	●	●	●	●	●
02	R1/4 (with M5 female thread)	●	●	●	●	●	●

## Options/Part Nos.

	Description	Part no.	Material	Note
①	Lead wire and M12 connector (3 m), Straight	ZS-37-A	—	1 pc.
②	Lead wire and M12 connector (3 m), Right angle	ZS-37-B	—	1 pc.
③	Assembly-type connector	PCA-1557743	—	1 pc.
④	Adapter with restrictor Rc1/4	ZS-31-X175	Stainless steel 304	1 pc.
⑤	Adapter with restrictor Rc1/8	ZS-31-X188	—	1 pc.
⑥	Orifice M5	ZS-48-A	Stainless steel 303	1 pc.
⑦	① + ③	ZS-37-A-X448	—	The lead wire and connector are shipped together. (but not assembled)
⑧	② + ③	ZS-37-B-X448	—	
⑨	Connector for pressure sensor controller connection	ZS-28-CA-4	—	1 pc.

## Specifications

For pressure switch precautions and specific product precautions, refer to the "Operation Manual" on the SMC website. [Click here](#) for details.

Model		PSE570	PSE573	PSE574	PSE575	PSE576	PSE577
<b>Fluid</b>	<b>Applicable fluid</b>	Gas or liquid that will not corrode materials of parts in contact with fluid					
<b>Pressure</b>	<b>Rated pressure range</b>	0 to 1 MPa	-100 to 100 kPa	0 to 500 kPa	0 to 2 MPa	0 to 5 MPa	0 to 10 MPa
	<b>Proof pressure</b>	3.0 MPa	600 kPa	1.5 MPa	5.0 MPa	12.5 MPa	30 MPa
<b>Electrical</b>	<b>Power supply voltage</b>	12 to 24 VDC ±10% with 10% voltage ripple or less					
	<b>Current consumption</b>	10 mA or less					
	<b>Protection</b>	Reverse connection protection					
<b>Accuracy</b>	<b>Analog output accuracy (Ambient temperature at 25°C)</b>	±1.0% F.S.				±2.5% F.S.	
	<b>Linearity</b>	±0.5% F.S.				±0.5% F.S.	
	<b>Repeatability (Ambient temperature at 25°C)</b>	±0.2% F.S.				±0.5% F.S.	
	<b>Temperature characteristics (25°C reference)</b>	±2%F.S. (0 to 50°C) ±3%F.S. (-10 to 60°C)	±3% F.S. (0 to 50°C) ±4% F.S. (-10 to 60°C)		±5% F.S. (-10 to 60°C)		
<b>Environment</b>	<b>Enclosure</b>	IP65					
	<b>Withstand voltage</b>	500 VAC for 1 minute between terminals and housing					
	<b>Insulation resistance</b>	100 MΩ or more (500 VDC measured via megohmmeter) between terminals and housing					
	<b>Operating temperature range</b>	Operating: -10 to 60°C, Stored: -20 to 70°C (No freezing or condensation)					
<b>Standards</b>	<b>Operating humidity range</b>	Operating/Stored: 35 to 85% RH (No condensation)					
	<b>Materials of parts in contact with fluid</b>	Piping port: C3604 + Nickel plating, Pressure sensor: Al <sub>2</sub> O <sub>3</sub> (Alumina 96%), Sensor seal: FKM + Grease			Piping port: C3604 + Nickel plating, Pressure sensor: Al <sub>2</sub> O <sub>3</sub> (Alumina 96%), Sensor seal: FKM		
<b>Analog output</b>	<b>Model</b>	PSE57□□□□			PSE57□□□□-2B		
	<b>Output</b>	Voltage output: 1 to 5 V			Current output: 4 to 20 mA		
	<b>Impedance</b>	Output impedance: Approx. 1 kΩ			Maximum load impedance: 500 Ω or less (at 24 VDC) 100 Ω or less (at 12 VDC)		

## Piping Specifications

Part no.		PSE570/573/574-01	PSE570/573/574-02	PSE575/576/577-02
<b>Port size</b>		R1/8 M5 x 0.8	R1/4 M5 x 0.8	R1/4 M5 x 0.8
	<b>Materials of parts in contact with fluid</b>	Piping port: C3604 + Nickel plating Pressure sensor: Al <sub>2</sub> O <sub>3</sub> (Alumina 96%) Sensor seal: FKM + Grease		Piping port: C3604 + Nickel plating Pressure sensor: Al <sub>2</sub> O <sub>3</sub> (Alumina 96%) Sensor seal: FKM
<b>Weight</b>	Without lead wire and M12 connector	88 g	95 g	103 g
	With lead wire and M12 connector	175 g	182 g	191 g

## Cable Specifications

<b>Conductor</b>	<b>Nominal cross section</b>	AWG23
	<b>Outside diameter</b>	0.72 mm
<b>Insulator</b>	<b>Material</b>	Cross-linked vinyl chloride
	<b>Outside diameter</b>	1.14 mm
<b>Sheath</b>	<b>Material</b>	Brown, Blue, Black, White
	<b>Oil resistant vinyl chloride</b>	
<b>Finished O.D.</b>	ø4	
<b>Length</b>	3 m	

# PSE570 Series

## Internal Circuits and Wiring Examples

### PSE57□-□

Voltage output type  
1 to 5 V  
Output impedance  
Approx. 1 k $\Omega$

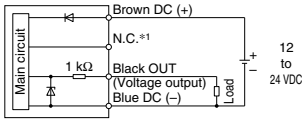

### PSE57□-□-28

Current output type  
4 to 20 mA  
Allowable load impedance  
500  $\Omega$  or less (at 24 VDC)  
100  $\Omega$  or less (at 12 VDC)

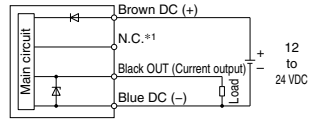

\*1 The unconnected terminals are used in SMC, so please do not connect them.

## Analog Output

### 1 to 5 VDC

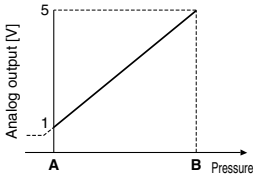

### 4 to 20 mA DC

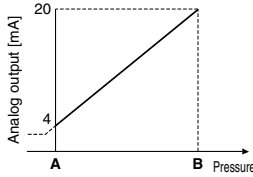

Model	Rated pressure range	A	B
PSE570	0 to 1 MPa	0 MPa	1 MPa
PSE573	-100 to 100 kPa	-100 kPa	100 kPa
PSE574	0 to 500 kPa	0 kPa	500 kPa
PSE575	0 to 2 MPa	0 MPa	2 MPa
PSE576	0 to 5 MPa	0 MPa	5 MPa
PSE577	0 to 10 MPa	0 MPa	10 MPa

## Dimensions

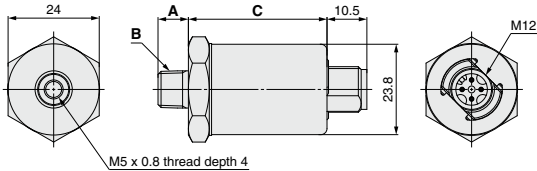

Part no.	[mm]		
	A	B	C
PSE570/573/574-01	8	R1/8	36.5
PSE570/573/574-02	12	R1/4	36.5
PSE575/576/577-02	12	R1/4	39.7

## Lead wire and M12 connector

### ZS-37-A

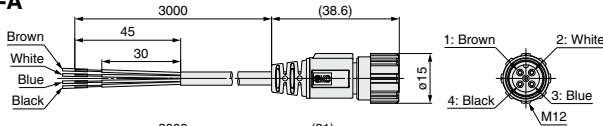

Pin no.	Lead wire color	Description
1	Brown	DC (+)
2	White	N.C.*1
3	Blue	DC (-)
4	Black	OUT1

\*1 The unconnected terminals are used in SMC, so please do not connect them.

### ZS-37-B

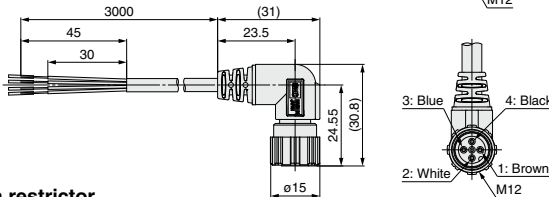

Part no.	Description
ZS-37-A	Straight type 3 m
ZS-37-B	Right angle type 3 m

## Adapter with restrictor

### ZS-31-X□□□

Material:  
Stainless steel 304

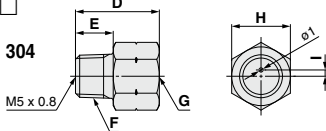

Part no.	[mm]					
	D	E	F	G	H	I
ZS-31-X188	20	9	R1/8	Rc1/8	14	1.5
ZS-31-X175	29	13	R1/4	Rc1/4	17	1.6

## Orifice

### ZS-48-A

Material:  
Stainless steel 303

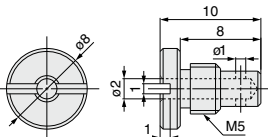

\* If it is expected that the pressure, such as the water hammer or surge pressure will fluctuate rapidly, refer to the Precautions in the Operation Manual on the SMC website (<http://www.smcworld.com>).

# Multi-Channel Digital Pressure Sensor Controller

## PSE200 Series



RoHS

Applicable sensors					Rated pressure range				Set/Display resolution
PSE53□	PSE54□	PSE55□	PSE56□	PSE57□	-100 kPa	0	100 kPa	1 MPa	
PSE531	PSE541	—	PSE561	—	-101 kPa	0			0.1 kPa
PSE533	PSE543	—	PSE563	PSE573	-101 kPa		101 kPa		0.1 kPa
PSE530	PSE540	—	PSE560	PSE570		0		1 MPa	0.001 MPa
PSE532		—		—		0	101 kPa		0.1 kPa

### ● A single controller monitors up to 4 pressure sensors.

- Sensor input: 4 inputs
- Switch output: 5 outputs (2 outputs for 1ch, 1 output for 2 to 4ch)

### ● Functions

- Auto-shift function
- Auto-preset function
- Auto-identification function
- Copy function
- Channel scan function
- Zero-clear function
- Keylock function
- Peak/Bottom values holding/display function
- Display unit switching function
- Display calibration function
- Anti-chattering function

76% reduction in installation space (Compared with the panel mounted ZSE40/ISE40)

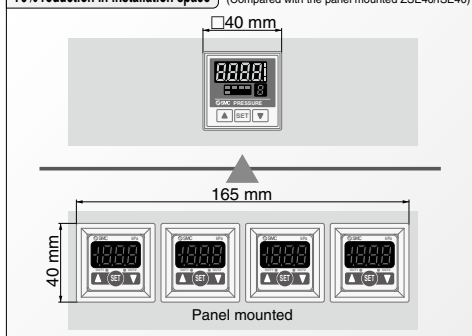

### Connector type

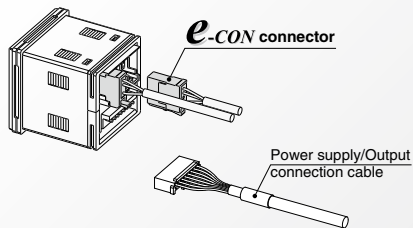

### A single controller monitors various applications.

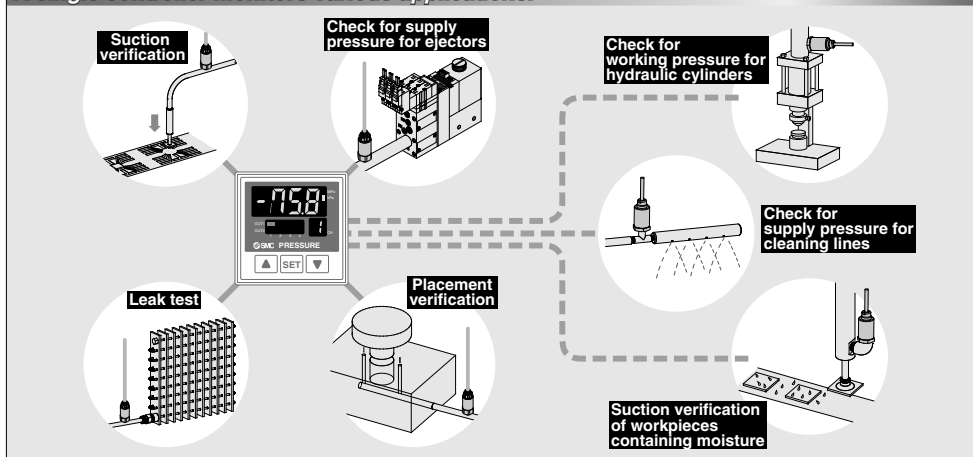

# Multi-Channel Controller **PSE200 Series**



## How to Order

PSE20 **0** - **M** □ □

### Input/Output specifications

<b>0</b>	NPN 5 outputs + Auto-shift input
<b>1</b>	PNP 5 outputs + Auto-shift input

### Unit specifications

<b>Nil</b>	With display unit switching function <small>Note 1)</small>
<b>M</b>	Fixed SI unit <small>Note 2)</small>

Note 1) Under the New Measurement Law, sales of switches with the unit switching function are not allowed for use in Japan.

Note 2) Fixed unit  
For vacuum, low pressure and compound pressure: kPa  
For positive pressure: MPa

### Accessory: Power supply/Output connection cable (2 m)

Included with the controller.

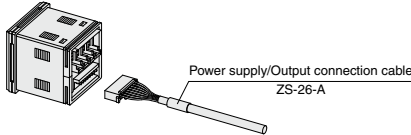

### Option 2

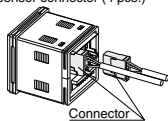
<b>Nil</b>	None
<b>4C</b>	Sensor connector (4 pcs.) 

Note) This connector cannot be used with the PSE570 series.

### Option 1

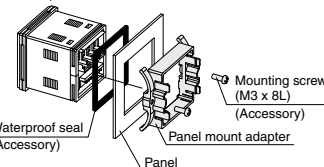
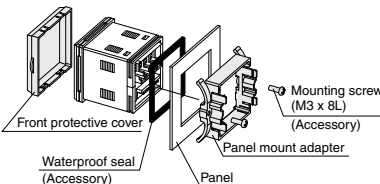
<b>Nil</b>	None
<b>A</b>	Panel mount adapter  Waterproof seal (Accessory) Mounting screw (M3 x 8L) (Accessory) Panel
<b>B</b>	Front protective cover + Panel mount adapter  Front protective cover Waterproof seal (Accessory) Mounting screw (M3 x 8L) (Accessory) Panel

## Option/Part No.

When only optional parts are required, order with the part numbers listed below.

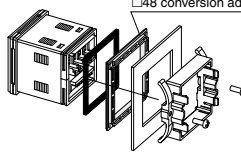
Description	Part no.	Note
Panel mount adapter	ZS-26-B	Waterproof seal, mounting screws M3 x 8L (2 pcs.) included
Front protective cover + Panel mount adapter	ZS-26-C	Waterproof seal, mounting screws M3 x 8L (2 pcs.) included
□48 conversion adapter  * This adapter is used to mount the PSE200 series on the panel fitting of the PSE100 series.	ZS-26-D  	□48 conversion adapter  Order panel mount adapter separately.
Front protective cover	ZS-26-01	
Sensor connector (1 pc. per set)	ZS-28-C ZS-28-CA-4	For the PSE□□ series (Excludes the PSE570 series) For PSE570 series

## Specifications

Refer to pages 11 and 12 for Pressure Switch Precautions. For details about the Specific Product Precautions, refer to the Operation Manual on the SMC website, <http://www.smcworld.com> Click [here](#) for details.

Model		PSE200	PSE201
<b>Power supply voltage</b>		12 to 24 VDC $\pm 10\%$ , Ripple (p-p) 10% or less (with reverse connection protection)	
<b>Current consumption</b>		55 mA or less (Current consumption for sensor is not included.)	
<b>Power supply voltage for sensor</b>		[Power supply voltage] -1.5 V	
<b>Power supply current for sensor</b> <sup>Note 1)</sup>		Maximum 40 mA (100 mA maximum for the total power supply current when 4 sensors are input.)	
<b>Sensor input</b>		1 to 5 VDC (Input impedance: Approx. 800 k $\Omega$ )	
	<b>Number of inputs</b>	4 inputs	
	<b>Input protection</b>	With excess voltage protection (Up to 26.4 V)	
<b>Switch output</b>		NPN open collector output: 5 outputs (Sensor input CH1: 2 outputs, CH2 to 4: 1 output)	PNP open collector output: 5 outputs (Sensor input CH1: 2 outputs, CH2 to 4: 1 output)
	<b>Maximum load current</b>	80 mA	
	<b>Maximum load voltage</b>	30 V	
	<b>Residual voltage</b>	1 V or less (with load current of 80 mA)	
	<b>Response time</b>	5 ms or less (Response time selections with anti-chattering function: 20 ms, 160 ms, 640 ms)	
	<b>Short circuit protection</b>	With short circuit protection	
<b>Repeatability</b>		$\pm 0.1\%$ F.S. $\pm 1$ digit	
<b>Hysteresis</b>	<b>Hysteresis mode</b>	Adjustable (can be set from 0)	
	<b>Window comparator mode</b>	Fixed (3 digits)	
<b>Display</b>		For measured value display: 4-digit, 7-segment indicator, Display color: Orange (Sampling frequency: 4 times/sec) For channel display: 1-digit, 7-segment indicator, Display color: Red	
<b>Display accuracy (Operating temperature at 25°C)</b>		$\pm 0.5\%$ F.S. $\pm 1$ digit	
<b>Indicator light</b>		Red (Lights up when output is turned ON.)	
<b>Auto-shift input</b>		Non-voltage input (Reed or Solid state), Input 10 ms or more, Independently controllable auto-shift function ON/OFF	
<b>Auto-identification function</b>		With auto-identification function <sup>Note 2)</sup>	
<b>Environment</b>	<b>Enclosure</b>	Front face: IP65 (when panel-mounted), Others: IP40 <sup>Note 3)</sup>	
	<b>Ambient temperature range</b>	Operating: 0 to 50°C, Stored: -10 to 60°C (No freezing or condensation)	
	<b>Ambient humidity range</b>	Operating/Stored: 35 to 85% RH (No condensation)	
<b>Temperature characteristics</b>		$\pm 0.5\%$ F.S. (25°C reference)	
<b>Connection</b>		Power supply/Output connection: 8P connector, Sensor connection: e-con connector	
<b>Material</b>		Housing: PBT; Display: Transparent nylon; Back rubber cover: CR	
<b>Weight</b>		Approx. 60 g (Excluding power supply/output cable)	
<b>Power supply/Output connection cable</b>		Heat resistant heavy-duty cable, 8 cores, $\phi 4.8$ , 2 m, Connector area: 0.15 mm <sup>2</sup> , Insulator O.D.: 0.9 mm	
<b>Standards</b>		CE, RoHS	

Note 1) If the Vcc and 0 V side of the sensor input connector are short circuited, the inside of the controller will be damaged.

Note 2) Auto-identification function comes with "the PSE53□ series" pressure sensor only. Other SMC series (PSE540, 560, 570) are not equipped with this function.

Note 3) IP40 when using the □48 conversion adapter.

## Applicable Pressure Sensor

Applicable sensor					Rated pressure range				Set/Display resolution
PSE53□	PSE54□	PSE55□	PSE56□	PSE57□	-100 kPa	0	100 kPa	1 MPa	
PSE531	PSE541	-	PSE561	-	-101 kPa	0			0.1 kPa
PSE533	PSE543	-	PSE563	PSE573	-101 kPa		101 kPa		0.1 kPa
PSE530	PSE540	-	PSE560	PSE570		0		1 MPa	0.001 MPa
PSE532		-		-		0	101 kPa		0.1 kPa

# PSE200 Series

## Internal Circuit and Wiring Example

### PSE200-(M)□

· NPN open collector 5 outputs + Auto-shift 1 input

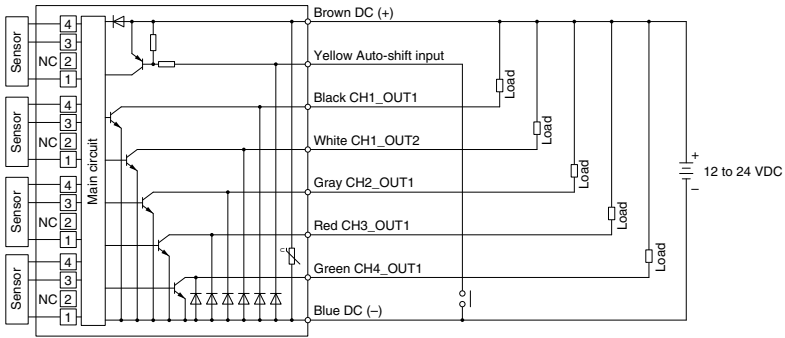

### PSE201-(M)□

· PNP open collector 5 outputs + Auto-shift 1 input

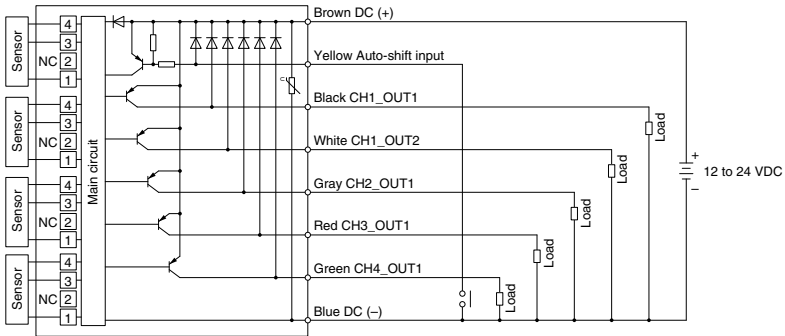

**Dimensions**

**PSE200/201**

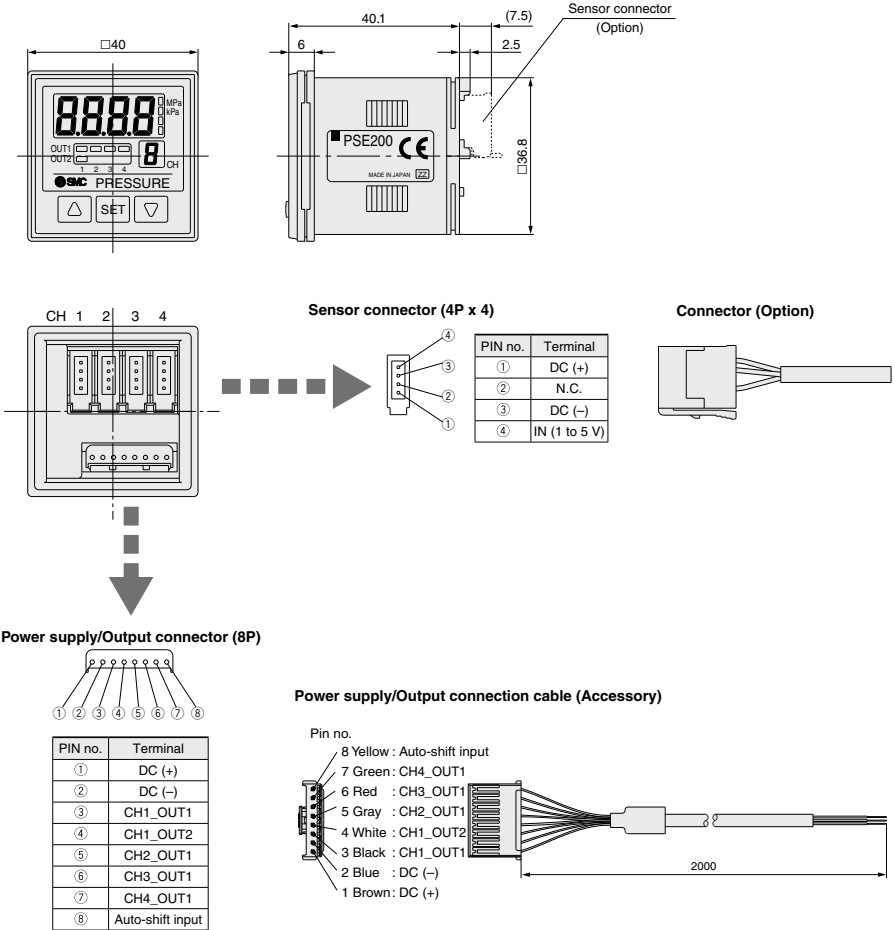

ZSE20
ISE20
ZSE30
ISE30
ZSE40
ISE40
ZSE10
ISE10
ISE70
ZSE80
ISE80
PS
ISA3
ISA2
ISE35
<b>PSE</b>
IS
ISG
ZSM1

# PSE200 Series

## Dimensions

Front protective cover + Panel mount adapter

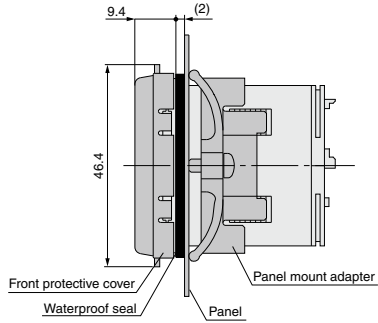
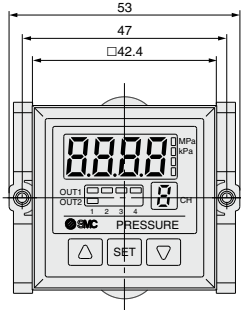

□48 conversion adapter + Panel mount adapter

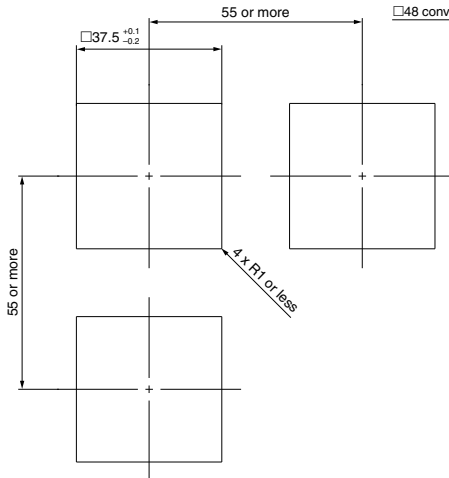
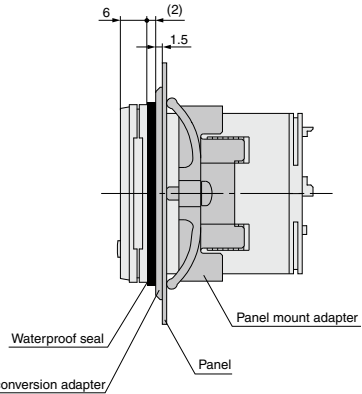
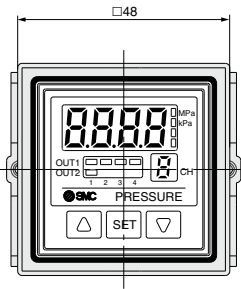

Panel fitting dimensions  
Applicable panel thickness: 0.5 to 8 mm





# 2-Color Display Digital Pressure Sensor Controller

## PSE300 Series



RoHS

Applicable sensors					Rated pressure range					Set/Display resolution
PSE53□	PSE54□	PSE55□	PSE56□	PSE57□	-100 kPa	0	100 kPa	500 kPa	1 MPa	
PSE531	PSE541	—	PSE561	—	-101 kPa	0				0.1 kPa
PSE533	PSE543	—	PSE563	PSE573	-100 kPa		100 kPa			0.2 kPa
PSE530	PSE540	—	PSE560	PSE570		0			1 MPa	0.001 MPa
PSE532	—	—	—	—		0	100 kPa			0.1 kPa
—	—	—	PSE564	PSE574		0		500 kPa		1 kPa
—	—	PSE550	—	—		0	2 kPa			0.01 kPa

### 2-color display (Red/Green)

Possible to set 4 patterns of display color.

Pattern	ON	OFF
①	Red	Green
②	Green	Red
③	Red	Red
④	Green	Green

Can be mounted in close proximity with each other either horizontally or vertically.

Possible to reduce panel fitting labor.

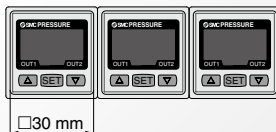

Response time

**1 ms**

### Connector type

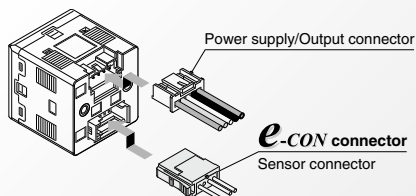

### ● Functions

- Auto-shift function
- Auto-preset function
- Display calibration function
- Peak/Bottom values holding/display function
- Keylock function
- Zero-clear function
- Error indication function
- Display unit switching function
- Anti-chattering function

### DIN rail/Terminal block type

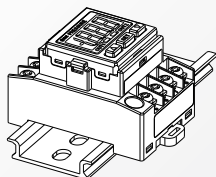

### Current input type

Electrical current input (4 to 20 mA DC) is added to the sensor input.

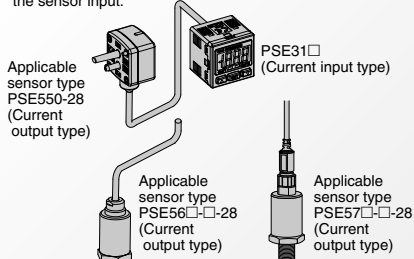

ZSE20  
ISE20  
ZSE30  
ISE30  
ZSE40  
ISE40  
ZSE10  
ISE10  
ISE70  
ZSE80  
ISE80  
PS  
ISA3  
ISA2  
ISE35  
PSE  
IS  
ISG  
ZSM1

# Pressure Sensor Controller

# PSE300 Series



## How to Order



DIN rail/Terminal block type

PSE3 0 0 T - M

Connector type

PSE3 0 0 - M



### Input specifications

0	Voltage input
1	Current input

### Input/Output specifications

0	NPN 2 outputs + 1-5 V output
1	NPN 2 outputs + 4-20 mA output
2	NPN 2 outputs + Auto-shift input
3	PNP 2 outputs + 1-5 V output
4	PNP 2 outputs + 4-20 mA output
5	PNP 2 outputs + Auto-shift input

### Unit specifications

NII	With display unit switching function <sup>Note 1)</sup>
M	Fixed SI unit <sup>Note 2)</sup>

Note 1) Under the New Measurement Law, sales of switches with the unit switching function are not allowed for use in Japan.

Note 2) Fixed unit  
 For vacuum, low pressure, low differential pressure and compound pressure: kPa  
 For positive pressure: MPa (For 1 MPa)  
 kPa (For 500 kPa)

### Option 1

NII	None
L	Power supply/Output connection cable

Note) The cable is not attached to the product, but is included with the shipment.

Order DIN rail separately. Refer to page 161.

## Option/Part No.

Description	Part no.	Note
Power supply/Output connection cable (2 m)	ZS-28-A	
Bracket	ZS-28-B	With M3 x 5L (2 pcs.)
Sensor connector (1 pc. per set)	ZS-28-C	For the PSE300 series (Excludes the PSE570 series)
	ZS-28-CA-4	For PSE570 series
Panel mount adapter	ZS-27-C	With M3 x 8L (2 pcs.)
Panel mount adapter + Front protective cover	ZS-27-D	With M3 x 8L (2 pcs.)
Front protective cover	ZS-27-01	1 pc.

### Option

NII	None
E	Front protective cover

### Option 3

NII	None
C	Sensor connector

Note) The connector is not attached to the cable, but is included with the shipment.

Note) This connector cannot be used with the PSE570 series.

### Option 2

NII	None
A	Bracket
B	Panel mount adapter
D	Panel mount adapter + Front protective cover

Note) These options are not attached to products, but are included with the shipment.

## Specifications

Refer to pages 11 and 12 for Pressure Switch Precautions. For details about the Specific Product Precautions, refer to the Operation Manual on the SMC website, <http://www.smcworld.com> Click [here](#) for details.

Model	PSE3□□					
Applicable pressure sensor	PSE533 PSE543 PSE563 PSE573	PSE531 PSE541 PSE561	PSE532	PSE530 PSE540 PSE560 PSE570	PSE564 PSE574	PSE550
Display/Set pressure (differential pressure) range	-101 to 101 kPa	10 to -101 kPa	-10 to 100 kPa	-0.1 to 1 MPa	-50 to 500 kPa	-0.2 to 2 kPa
Display/Set resolution	0.2 kPa	0.1 kPa	0.1 kPa	0.001 MPa	1 kPa	0.01 kPa
Pressure range <sup>Note 1)</sup>	For compound pressure	For vacuum	For low pressure	For positive pressure		For low differential pressure
Rated pressure (differential pressure) range	-100 to 100 kPa	0 to -101 kPa	0 to 100 kPa	0 to 1 MPa	0 to 500 kPa	0 to 2 kPa
Extension analog output range <sup>Note 2)</sup>	—	10.1 to 0 kPa	-10 to 0 kPa	-0.1 to 0 MPa	-50 to 0 kPa	-0.2 to 0 kPa
Power supply voltage	12 to 24 VDC ±10%, Ripple (p-p) 10% or less (with reverse connection protection)					
Current consumption	50 mA or less (Current consumption for sensor is not included.)					
Sensor input	PSE30□: Voltage input 1 to 5 VDC (Input impedance: 1 MΩ) PSE31□: Current input 4 to 20 mA DC (Input impedance: 100 Ω)					
	Number of inputs	1 input				
	Input protection	With excess voltage protection (Up to 26.4 V)				
Hysteresis	Hysteresis mode: Variable, Window comparator mode: Variable					
Switch output	NPN or PNP open collector output: 2 outputs					
	Maximum load current	80 mA				
	Maximum load voltage	30 VDC (at NPN output)				
	Residual voltage	1 V or less (with load current of 80 mA)				
Output protection	With short circuit protection					
Response time	1 ms or less					
Anti-chattering function	Response time settings for anti-chattering function: 20 ms, 160 ms, 640 ms, 1280 ms					
Repeatability	±0.1% F.S.					
Analog output	Voltage output <sup>Note 2)</sup>	Output voltage: 1 to 5 V (within rated pressure (differential pressure) range), 0.6 to 1 V (within extension analog output range) Output impedance: Approx. 1 kΩ, Linearity: ±0.2% F.S. (Not including sensor accuracy), Response speed: 150 ms or less				
	Accuracy (To display value) (25°C)	±0.6% F.S.		±1.0% F.S.		±1.5% F.S.
	Current output <sup>Note 2)</sup>	Output current: 4 to 20 mA (within rated pressure (differential pressure) range), 2.4 to 4 mA (within extension analog output range) Maximum load impedance: 300 Ω (at 12 VDC), 600 Ω (at 24 VDC), Minimum load impedance: 50 Ω Linearity: ±0.2% F.S. (Not including sensor accuracy), Response time: 150 ms or less				
	Accuracy (To display value) (25°C)	±1.0% F.S.		±1.5% F.S.		±2.0% F.S.
Display accuracy (Ambient temperature at 25°C)	±0.5% F.S. ±2 digits	±0.5% F.S. ±1 digit				
Display	3 + 1/2 digit, 7 segment indicator, 2-color display (Red/Green), Sampling frequency: 5 times/sec					
Indicator light	OUT1: Lights up when turned ON (Green), OUT2: Lights up when turned ON (Red)					
Auto-shift input <sup>Note 2)</sup>	Non-voltage input (Reed or Solid state), Low level input: 5 ms or more, Low level: 0.4 V or less					
Environment	Enclosure	IP40				
	Operating temperature range	Operating: 0 to 50°C, Stored: -10 to 60°C (No freezing or condensation)				
	Operating humidity range	Operating/Stored: 35 to 85% RH (No condensation)				
	Withstand voltage	1000 VAC for 1 minute between terminals and housing				
	Insulation resistance	50 MΩ or more (500 VDC measured via megohmmeter) between terminals and housing				
Temperature characteristics	±0.5% F.S. (25°C reference)					
Connection	PSE30□□: Power supply/Output connection: 5P connector, Sensor connection: 4P connector PSE31□□: Terminal block					
Material	Front case: PBT, Rear case: PBT (PSE30□□), Modified PPE (PSE31□□)					
Weight	With power supply/Output connection cable	PSE30□□: 85 g				
	Without power supply/Output connection cable	PSE30□□: 30 g, PSE31□□: 50 g				
Power supply/Output connection cable	Oilproof heavy-duty vinyl cable, 5 cores, ø4.1, 2 m, Conductor area: 0.2 mm <sup>2</sup> Insulator O.D.: 1.12 mm					
Standards	CE, UL/CSA (E216656), RoHS					

Note 1) Pressure range can be selected during initial setting.

Note 2) Auto-shift function is not available when analog output option is selected.

Also, analog output option is not available when auto-shift function is selected.  
Extension analog output is not available for the PSE570 series.

Note 3) The following units can be selected with display unit switching function:

For vacuum & compound pressure: kPa·kgf/cm<sup>2</sup>·bar·psi·mmHg·in·Hg  
For positive pressure & low pressure: MPa·kPa·kgf/cm<sup>2</sup>·bar·psi  
For low differential pressure: kPa·mmH<sub>2</sub>O

## Analog Output

### 1 to 5 VDC

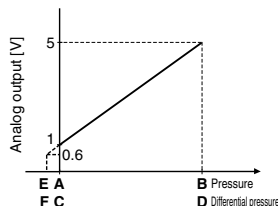

### 4 to 20 mA DC

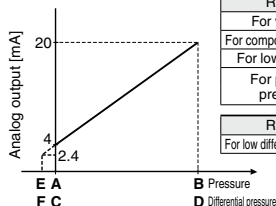

Range	Rated pressure range	A	B	E
For vacuum	0 to -101 kPa	0	-101 kPa	10.1 kPa
For compound pressure	-100 kPa to 100 kPa	-100 kPa	100 kPa	—
For low pressure	0 to 100 kPa	0	100 kPa	-10 kPa
For positive pressure	0 to 1 MPa	0	1 MPa	-0.1 MPa
	0 to 500 kPa	0	500 kPa	-50 kPa
Range	Rated pressure range	C	D	F
For low differential pressure	0 to 2 kPa	0	2 kPa	-0.2 kPa

# PSE300 Series

## Internal Circuit and Wiring Example

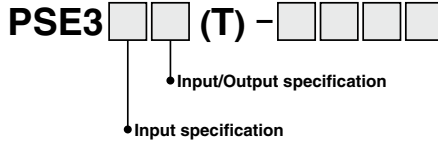

### PSE30(T)

NPN (2 outputs) + Analog voltage output

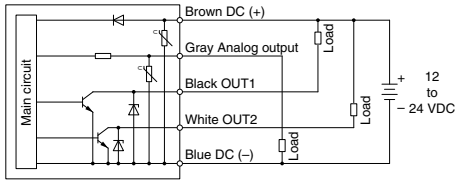

### PSE31(T)

NPN (2 outputs) + Analog current output

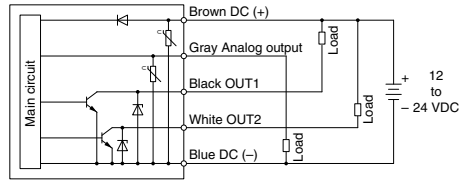

### PSE32(T)

NPN (2 outputs) + Auto-shift 1 input

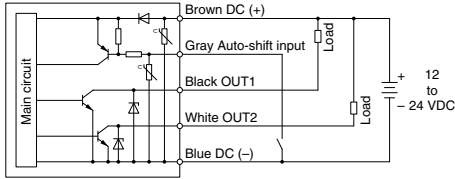

### PSE33(T)

PNP (2 outputs) + Analog voltage output

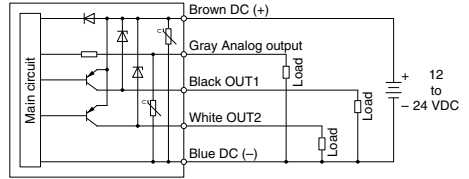

### PSE34(T)

PNP (2 outputs) + Analog current output

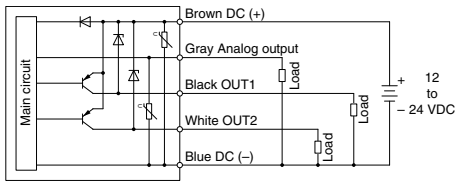

### PSE35(T)

PNP (2 outputs) + Auto-shift 1 input

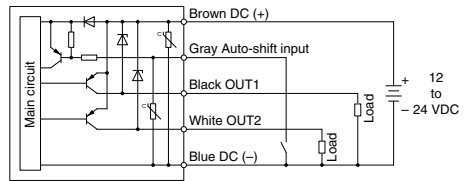

## Connector for Sensor Connection

PIN no.	Terminal		
	PSE30 <input type="checkbox"/> (Voltage input)	PSE31 <input type="checkbox"/> (Current input)	
		Pressure sensor 2-wire type	Pressure sensor 3-wire type
1	DC (+) (Brown)	DC (+) (Brown)	DC (+) (Brown)
2	N.C.	N.C.	N.C.
3	DC (-) (Blue)	N.C.	DC (-) (Blue)
4	IN (1 to 5 V) (Black)	IN (4 to 20 mA) (Blue)	IN (4 to 20 mA) (Black)

Note: The colors in ( ) indicate the wire color of the PSE5 series.

## Dimensions

PSE3□□

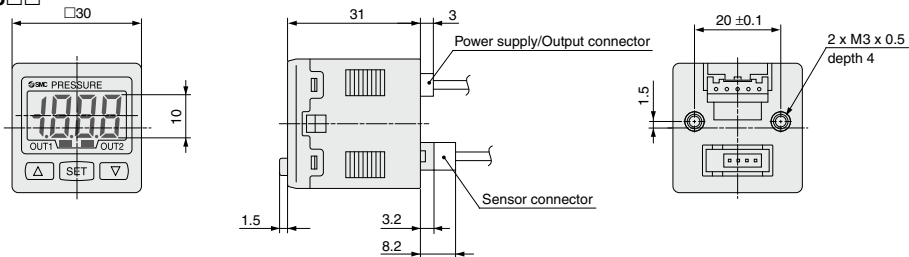

### Power supply/Output connection cable (ZS-28-A)

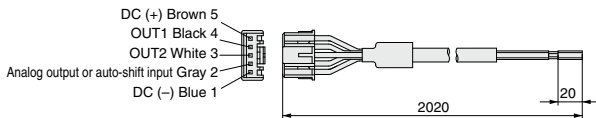

### Sensor connector

PIN no.	Terminal	
	PSE30□	PSE31□
1	DC(+)(Brown)	DC(+)(Brown)
2	N.C.	N.C.
3	DC(-)(Blue)	N.C.
4	IN (1 to 5 V) (Black)	IN (4 to 20 mA) (Blue)

Note: The colors in ( ) indicate the wire color of the PSE5□□ series.

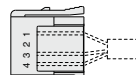

### With bracket

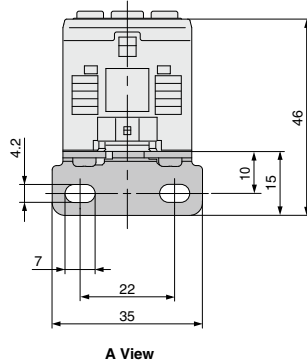
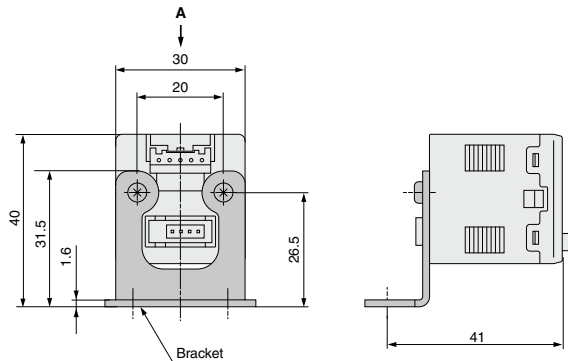

### With panel mount adapter

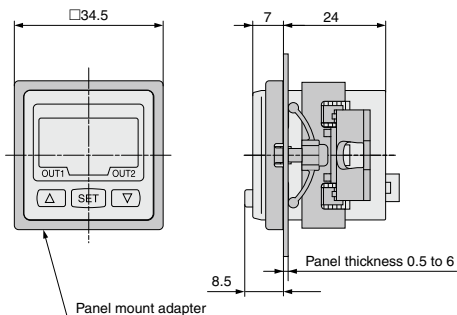

### With panel mount adapter + Front protective cover

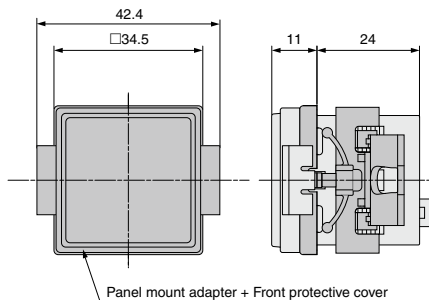

- ZSE20  
ISE20
- ZSE30  
ISE30
- ZSE40  
ISE40
- ZSE10  
ISE10
- ISE70
- ZSE80  
ISE80
- PS
- ISA3
- ISA2
- ISE35
- PSE
- IS
- ISG
- ZSM1

# PSE300 Series

## Dimensions

### Panel fitting dimensions

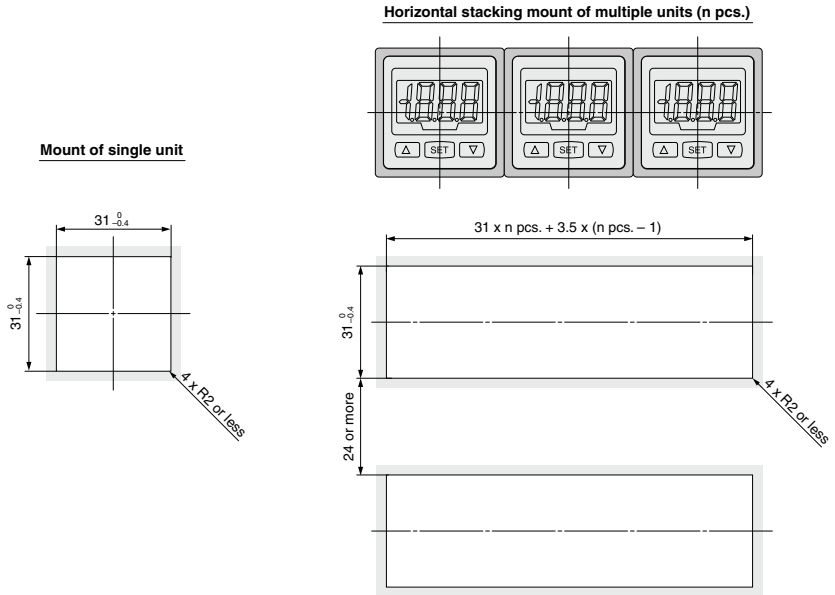

### Vertical stacking mount of multiple units (n pcs.)

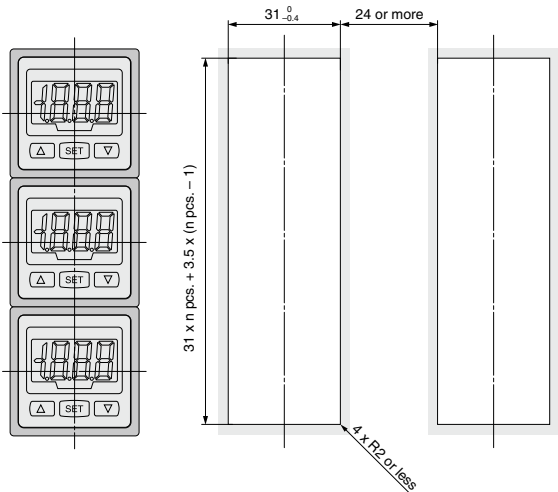

## Dimensions

### PSE3□□T

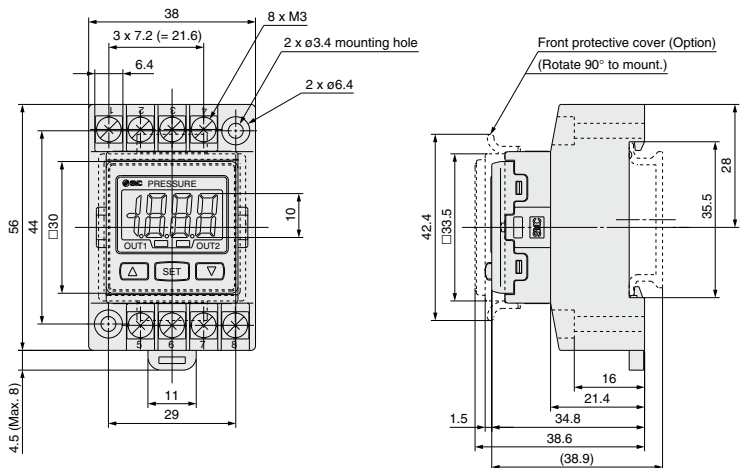

## Connections

### PSE3□□T

(Voltage input, Current input: Pressure sensor 3-wire type)

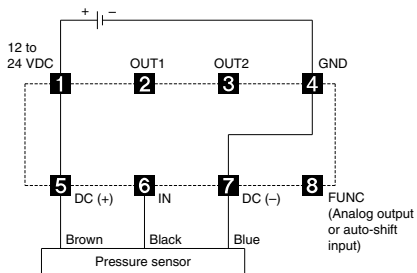

### PSE31□T

(Current input: Pressure sensor 2-wire type)

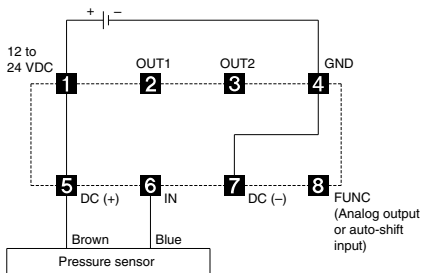

## DIN Rail

### ISA-5-□

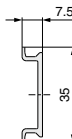
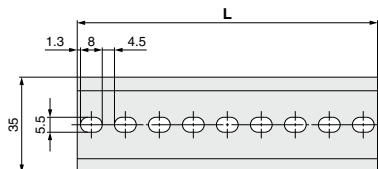

Part no.	L
ISA-5-1	73.0
ISA-5-2	135.5
ISA-5-3	173.0
ISA-5-4	210.5
ISA-5-5	248.0
ISA-5-6	285.5
ISA-5-7	323.0

## Function Details

### A Auto-shift function

When there are large fluctuations in the supply pressure, the switch may fail to operate correctly. The auto-shift function compensates such supply pressure fluctuations. It measures the (differential) pressure at the time of auto-shift signal input and uses it as the reference (differential) pressure to correct the set value on the switch.

#### Set value correction by auto-shift function

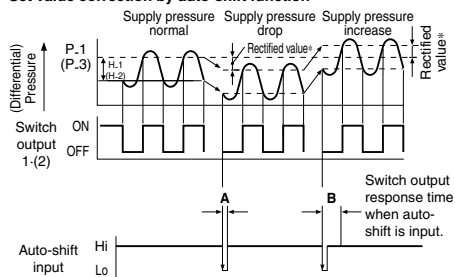

	A Auto-shift input time	B Switch output response time at time of auto-shift input
<b>PSE200</b>	10 ms or more	15 ms or less
<b>PSE300</b>	5 ms or more	10 ms or less

#### \* Rectified value

When the auto-shift is selected, "ooo" will be displayed for approximately 1 second, and the pressure value at that point will be saved as a rectified value "C\_5" (for CH1 of PSE200 and PSE300) or "C\_3" (for CH2 to 4 for PSE200). Based on the saved rectified values (Note), the set value "P\_1" to "P\_4" (for PSE200) or "P\_1", "H\_1", "P\_3", "H\_2" (for PSE300) will likewise be rectified.

Note) When an output is reversed, "n\_1" to "n\_4" (for PSE200) or "n\_1", "H\_1", "n\_3", "H\_2" (for PSE300) will be rectified.

#### Settable Range for Auto-Shift Input

PSE200	Set pressure (differential pressure) range	Settable range
Compound pressure	-101.0 to 101.0 kPa	-101.0 to 101.0 kPa
Vacuum	10.0 to -101.0 kPa	101.0 to -101.0 kPa
Low pressure	-10.0 to 101.0 kPa	-100.0 to 101.0 kPa
Positive pressure	-0.1 to 1.000 MPa	-1.000 to 1.000 MPa
Low differential pressure	—	—

PSE300	Set pressure (differential pressure) range	Settable range
Compound pressure	-101.0 to 101.0 kPa	-101.0 to 101.0 kPa
Vacuum	10.0 to -101.0 kPa	101.0 to -101.0 kPa
Low pressure	-10 to 100.0 kPa	-100.0 to 100.0 kPa
Positive pressure	-0.1 to 1.000 MPa	-1.000 to 1.000 MPa
	-50 to 500 kPa	-500 to 500 kPa
Low differential pressure	-0.2 to 2.00 kPa	-2.00 to 2.00 kPa

#### Auto-shift zero (PSE300 series only)

The basic function of auto-shift zero is the same as the function for auto-shift. Also, it corrects values on the display, based on a pressure value of 0, when the auto-shift is selected.

### Auto-shift circuit

#### PSE□□2

PNP open collector output: 2 outputs

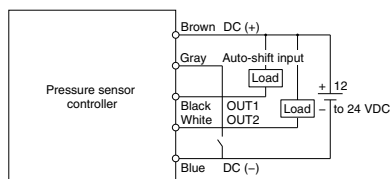

#### PSE□□5

PNP open collector output: 2 outputs

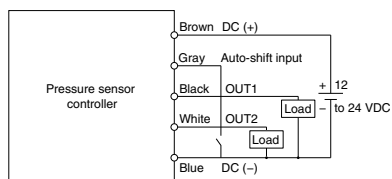

Note) The colors in the circuit diagram indicate the color of the lead wire when it is connected to the power supply/output connection cable (ZS-28-A).

### B Auto-preset function

Auto-preset function, when selected in the initial setting, calculates and stores the set-value from the measured (differential) pressure. The optimum set-value is determined automatically by repeating vacuum and break with the target workpiece several times.

#### Suction Verification

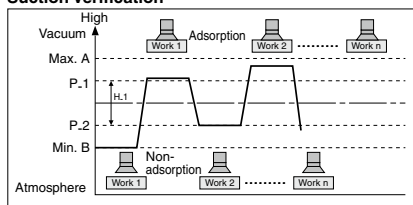

#### Formula for Obtaining the Set Value

	P_1 or P_3	P_2(H_1) or P_4(H_2)
<b>PSE200</b>		$P_2(P_4)=B+(A-B)/4$
<b>PSE300</b>	$P_1(P_3)=A-(A-B)/4$	$H_1(H_2)=(A-B)/2$



## Function Details

### C Display calibration function

Fine adjustment of the indicated value of the pressure sensor can be made within the range of  $\pm 5\%$  of the read value.  
(The scattering of the indicated value can be eliminated.)

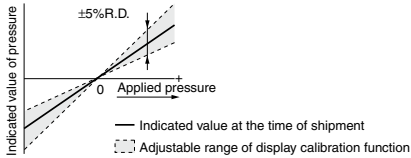

(Note) When the display calibration function is used, the set pressure value may change  $\pm 1$  digit.

### D Peak/Bottom values holding/display function

This function constantly detects and updates the maximum and minimum values and allows to hold the display value.  
For PSE300, when the  $\Delta \nabla$  are simultaneously pressed for 1 second or longer, while "holding", the hold value will be reset.

### E Keylock function

Prevents operation errors such as accidentally changing setting values.

### F Zero-clear function

This function clears and resets the zero value on the display of measured (differential) pressure within  $\pm 7\%$  F.S. of the factory adjusted value.

### G Error indication function

Error name	Error code		Description
	PSE200	PSE300	
Overcurrent error	Er 1	Er 1	Load current of 80 mA or more is applied to the switch output (OUT1).
	Er 2	Er 2	Load current of 80 mA or more is applied to the switch output (OUT2).
Residual pressure error	Er 3	Er 3	Pressure applied during the zero reset operation exceeds $\pm 7\%$ F.S. * After displaying the error code for 3 seconds, the switch automatically returns to the measuring mode. Due to individual product differences, the setting range varies $\pm 4$ digits.
Applied pressure error	---	HHH	Supply pressure exceeds the maximum set (differential) pressure or upper limit of the display pressure.
	----	LLL	A sensor may be disconnected or mis-wired. Or, supply pressure is below the minimum set (differential) pressure or lower limit of the display pressure.
Auto-shift error	/	or	The value measured at the time of auto-shift input is outside the set (differential) pressure range. * After displaying the error code for one second, the switch returns to the measuring mode.
System error	Er 5	Er 4	Internal data error
	Er 6	Er 6	Internal data error
	Er 7	Er 7	Internal data error
	Er 8	Er 8	Internal data error

### H Copy function (PSE200 series only)

Information that can be copied includes the following: ① Pressure set values, ② Range settings, ③ Display units, ④ Output modes, ⑤ Response times.

- When CH1 is copied to CH2, CH3, and CH4, information of OUT1 in CH1 will be copied.
- When CH2, CH3, or CH4 is copied to CH1, information of OUT1 in CH2, CH3, or CH4 will be copied only to OUT1 in CH1.

(Note) When the copy function is used, the regulating pressure value of the copied channel may change  $\pm 1$  digit.

### I Auto-identification function (PSE200 series only)

This function automatically identifies the pressure range of the pressure sensor that is connected to the multi-channel pressure sensor controller, thus eliminating the need of having to reset the range again after replacing the sensor. This function will be activated either when "Aon" is set in the auto-identification mode or when the power is turned back on in that condition. However, this function only works in conjunction with specific pressure sensors (SMC PSE53□ series). When other pressure sensors are used, this function will not work. When using other types of pressure sensors, first set the auto-identification mode to "AoF", and then proceed to setting the range. Turning the power back on while in the "Aon" setting can cause a malfunction.

### J Anti-chattering function

A large bore cylinder or ejector consumes a large volume of air in operation and may experience a temporary drop in the supply pressure. This function prevents detection of such temporary drops in the supply pressure as an error.

	Available response time settings
PSE200	20 ms, 160 ms, 640 ms
PSE300	20 ms, 160 ms, 640 ms, 1280 ms

<Principle>

This function averages pressure values measured during the response time set by the user and then compares the average pressure value with the pressure set point value to output the result on the switch.

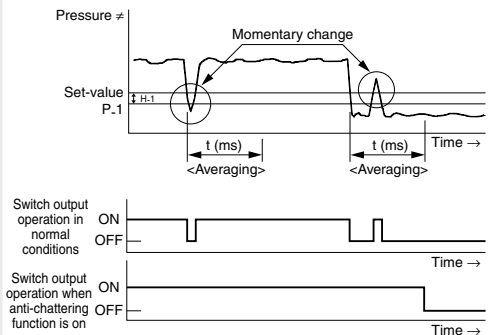

### K Channel selection function (PSE200 series only)

Pressure value for the selected channel is displayed.

### L Channel scan function (PSE200 series only)

Pressure values for each channel are displayed by turns at 2-second intervals.

ZSE20  
ISE20

ZSE30  
ISE30

ZSE40  
ISE40

ZSE10  
ISE10

ISE70

ZSE80  
ISE80

PS

ISA3

ISA2

ISE35

PSE

IS

ISG

ZSM1

# PSE200/300 Series

## Function Details

### M Display unit switching function

Display units can be switched with this function. Units that can be displayed vary depending on the range of the pressure sensors connected to the controller.

#### PSE200

Pressure range	For compound pressure	For vacuum	For low pressure	For positive pressure	
Applicable pressure sensor	PSE533 PSE543 PSE563 PSE573	PSE531 PSE541 PSE561	PSE532	PSE530 PSE540 PSE560 PSE570	
Set pressure (differential pressure) range	-101 to 101 kPa	10 to -101 kPa	-10 to 101 kPa	-0.1 to 1 MPa	
P <sub>R</sub>	kPa	0.1	0.1	0.1	—
	MPa	—	—	—	0.001
G <sub>F</sub>	kgf/cm <sup>2</sup>	0.001	0.001	0.001	0.01
b <sub>R</sub> r	bar	0.001	0.001	0.001	0.01
P <sub>S</sub> i	psi	0.02	0.01	0.01	0.1
i <sub>n</sub> H	inHg	0.1	0.1	—	—
n <sub>n</sub> H	mmHg	1	1	—	—

#### PSE300

Pressure range	For compound pressure	For vacuum	For low pressure	For positive pressure	For low differential pressure		
Applicable pressure sensor	PSE533 PSE543 PSE563 PSE573	PSE531 PSE541 PSE561	PSE532	PSE530 PSE540 PSE560 PSE570	PSE564 PSE574 PSE550		
Set pressure (differential pressure) range	-101 to 101 kPa	10 to -101 kPa	-10 to 100 kPa	-0.1 to 1 MPa	-50 to 500 kPa	-0.2 to 2.00 kPa	
P <sub>R</sub>	kPa	0.2	0.1	0.1	—	1	0.01
	MPa	—	—	—	0.001	—	—
G <sub>F</sub>	kgf/cm <sup>2</sup>	0.002	0.001	0.001	0.01	0.01	—
b <sub>R</sub> r	bar	0.002	0.001	0.001	0.01	0.01	—
P <sub>S</sub> i	psi	0.05	0.02	0.02	0.2	0.1	—
i <sub>n</sub> H	inHg	0.1	0.1	—	—	—	—
n <sub>n</sub> H	mmHg	2	1	—	—	—	1 mmH <sub>2</sub> O

# 3-Screen Display Sensor Monitor

# PSE300AC Series



## How to Order



PSE3 **0** **0** OAC - **AB** - **M** - **□**

### Input specification

0	Voltage input
1	Current input

### Output specification

**AB** | 2 output type (NPN or PNP switching type)

### Option (Power supply/output lead wire)

<b>NH</b>	Straight lead wire
<b>L</b>	Right angle lead wire
<b>N</b>	None

## Options/Part Nos.

Description	Part no.	Note
Power supply/output lead wire	ZS-31-B	Straight (5 m) 1 pc.
	ZS-31-C	Right angle (5 m) 1 pc.

\* For details on the lead wire with M12 connector and the assembly type connector for connecting to the sensor, refer to page 147.

### Unit specification

<b>NH</b>	With unit selection function*1
<b>M</b>	SI unit only*2
<b>P</b>	With unit selection function (Initial value psi)*1

\*1 Under the new Measurement Act, sales of switches with the unit selection function have not been allowed for use in Japan.

\*2 Fixed unit: Pa, kPa, MPa

For pressure switch precautions and specific product precautions, refer to the "Operation Manual" on the SMC website. Click [here](#) for details.

## Specifications

### M12 Connector Type

Series		PSE300AC								
Applicable SMC pressure sensor		PSE550	PSE531/PSE541 PSE561	PSE533/PSE543 PSE563/PSE573	PSE532	PSE564 PSE574	PSE530/PSE540 PSE560/PSE570	PSE575	PSE576	PSE577
<b>Rated pressure range</b>		0 to 2 kPa	0 to -101 kPa	-100 to 100 kPa	0 to 100 kPa	0 to 500 kPa	0 to 1 MPa	0 to 2 MPa	0 to 5 MPa	0 to 10 MPa
<b>Display/Set pressure range</b>		-0.2 to 2.1 kPa	10 to -105 kPa	-105 to 105 kPa	-10 to 105 kPa	-50 to 525 kPa	-0.105 to 1.05 MPa	-0.105 to 2.1 MPa	-0.1 to 5.25 MPa	-0.1 to 10.5 MPa
<b>Display/Smallest settable increment</b>		0.001 kPa	0.1 kPa	0.1 kPa	0.1 kPa	1 kPa	0.001 MPa	0.001 MPa	0.01 MPa	0.01 MPa
<b>Electrical</b>	<b>Power supply voltage</b>	12 to 24 VDC (±10%) with 10% voltage ripple or less								
	<b>Current consumption</b>	25 mA or less								
<b>Accuracy</b>	<b>Protection</b>	Reverse connection protection								
	<b>Display accuracy</b>	±0.5% F.S. ±Min. display unit (Ambient temperature at 25°C)								
	<b>Repeatability</b>	±0.1% F.S. ±Min. display unit (Ambient temperature at 25°C)								
	<b>Temperature characteristics</b>	±0.5% F.S. (Ambient temperature of 0 to 50°C, 25°C reference)								
<b>Switch output</b>	<b>Output type</b>	Select from NPN or PNP open collector output.								
	<b>Output mode</b>	Select from hysteresis mode, window comparator mode, error output or switch output OFF.								
	<b>Switch operation</b>	Select from normal output or reverse output.								
	<b>Max. load current</b>	20 mA								
	<b>Max. applied voltage (NPN only)</b>	30 VDC								
	<b>Internal voltage drop (Residual voltage)</b>	1 V or less (with load current of 20 mA)								
	<b>Delay time</b> *1	1 ms or less (with anti-chattering function: 20, 100, 500, 1000, 2000, 5000 ms)								
<b>Sensor input</b>	<b>Hysteresis</b>	Variable from 0**2								
	<b>Protection</b>	Over current protection								
	<b>Input type</b>	Voltage input: 1 to 5 VDC (Input impedance: 1 MΩ), Current input: 4 to 20 mA DC (Input impedance: 51 Ω)								
	<b>Number of inputs</b>	1 input								
<b>Display</b>	<b>Connection method</b>	M12-4 pin connector								
	<b>Protection</b>	Over voltage protection (up to a voltage of 26.4 VDC)								
	<b>Unit</b> *3	MPa, kPa, Pa, kgf/cm <sup>2</sup> , bar, mbar, psi, inHg, mmHg, mmHzO								
	<b>Display type</b>	LCD								
	<b>Number of screens</b>	3-screen display (Main screen, Sub screen x 2)								
<b>Digital filter</b> *4	<b>Display color</b>	1) Main screen: Red/Green, 2) Sub screen: Orange								
	<b>Number of display digits</b>	1) Main screen: 4-digit (7-segment), 2) Sub screen: 4-digit (Upper 1-digit 11-segment, 7-segment for other)								
	<b>Indicator light</b>	Lights up when switch output is turned ON. OUT1/OUT2: Orange								
<b>Environment</b>	<b>Enclosure</b>	IP65								
	<b>Withstand voltage</b>	1000 VAC for 1 minute between terminals and housing								
	<b>Insulation resistance</b>	50 MΩ or more (500 VDC measured via megohmmeter) between terminals and housing								
	<b>Operating temperature range</b>	Operating: 0 to 50°C, Stored: -10 to 60°C (No freezing or condensation)								
	<b>Operating humidity range</b>	Operating/Stored: 35 to 85% RH (No condensation)								
<b>Standards</b>	CE (EMC directive/RoHS directive)									
<b>Weight</b>	55.4 g (without power supply or output lead wires)									

\*1 Value without digital filter (at 0 ms)

\*2 If the applied pressure fluctuates around the set value, the hysteresis must be set to a value more than the amount of fluctuation, or chattering will occur.

\*3 This setting is only available for models with the unit selection function.

Only MPa, kPa or Pa is available for models without this function.

\*4 The response time indicates when the set value is 90% in relation to the step input.

**Internal Circuits and Wiring Examples**

Setting of NPN open collector 2 outputs: Pressure sensor 3-wire type

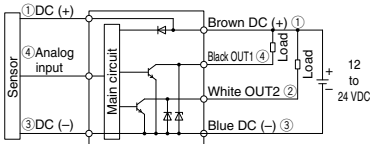

Setting of PNP open collector 2 outputs: Pressure sensor 3-wire type

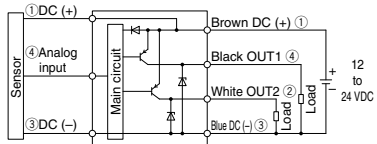

Setting of NPN open collector 2 outputs: Pressure sensor 2-wire type

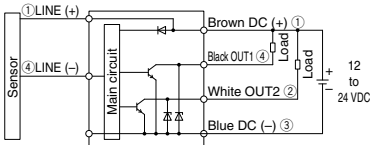

Setting of PNP open collector 2 outputs: Pressure sensor 2-wire type

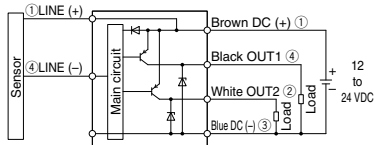

- \* The output type can be changed in the function selection mode.
- \* Numbers in the figures show the connector pin layout.

**Dimensions**

Power supply/output connector pin no.

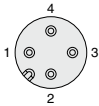

Pin no.	Description
1	DC (+)
2	OUT2
3	DC (-)
4	OUT1

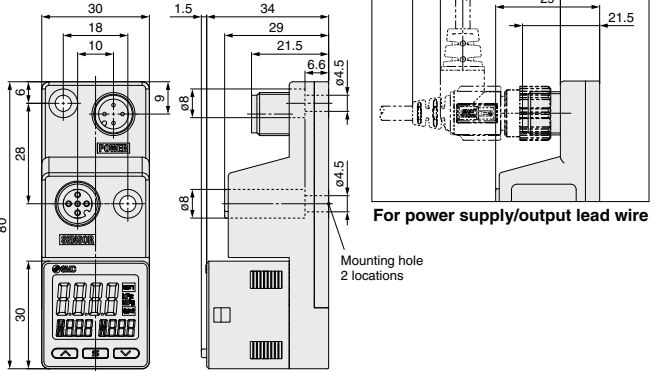

Sensor connector pin no.

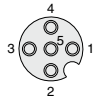

Pin no.	Description
1	DC (+)
2	N.C.
3	DC (-)
4	Sensor input (1 to 5 V, 4 to 20 mA)
5	N.C.

For power supply/output lead wire

Power supply/output lead wire  
**ZS-31-B**

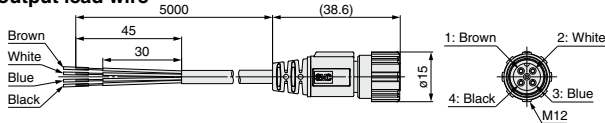

**ZS-31-C**

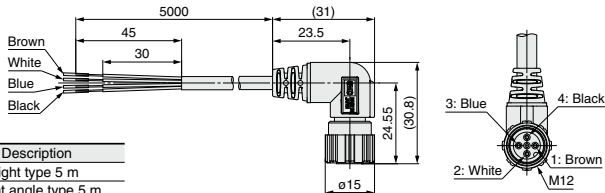

Pin no.	Lead wire color	Description
1	Brown	DC (+)
2	White	OUT2
3	Blue	DC (-)
4	Black	OUT1

Part no.	Description
ZS-31-B	Straight type 5 m
ZS-31-C	Right angle type 5 m

ZSE20
ISE20
ZSE30
ISE30
ZSE40
ISE40
ZSE10
ISE10
ISE70
ZSE80
ISE80
PS
ISA3
ISA2
ISE35
PSE
IS
ISG
ZSM1

## Function Details

### A Auto-preset function (F4)

Auto-preset function, when selected in the initial setting, calculates and stores the set value from the measured pressure. For example, if this function is used for suction verification, the optimum set value is determined automatically by repeating vacuum and break with the target workpiece several times.

#### Suction Verification

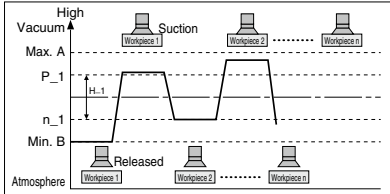

#### Formula for Obtaining the Set Value

P_1 or P_2	H_1 or H_2
$P_1 (P_2) = A - (A-B)/4$	$H_1 (H_2) = [(A-B)/2]$
$n_1 (n_2) = B + (A-B)/4$	

### B Display value fine adjustment function (F6)

Fine adjustment of the indicated value of the pressure sensor can be made within the range of  $\pm 5\%$  of the read value. (The scattering of the indicated value can be eliminated.)

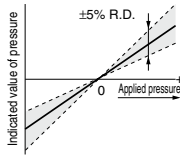

— Indicated value at the time of shipment  
 - - - Adjustable range of display value fine adjustment function

Note) When the display value fine adjustment function is used, the set pressure value may change  $\pm 1$  digit.

### C Peak/Bottom value indication function

This function constantly detects and updates the maximum (minimum) pressure when the power is supplied, and allows to hold the maximum (minimum) pressure value.

The held value is maintained even if the power supply is cut. When the buttons are simultaneously pressed for 1 second or longer, while "holding", the held value will be reset.

### D Keylock function

Prevents operation errors such as accidentally changing setting values.

### E Zero-clear function

This function clears and resets the zero value on the display of measured pressure.

The indicated value can be adjusted within  $\pm 7\%$  F.S. of the pressure when ex-factory. ( $\pm 3.5\%$  F.S. for compound pressure)

### F Error indication function

This function is to display error location and content when a problem or error has occurred.

Error name	Error code	Description	Action
Over current error		Load current of 20 mA or more is applied to the switch output.	Turn the power off and remove the cause of the over current. Then supply the power again.
Residual pressure error		During zero-clear operation, pressure over $\pm 7\%$ F.S. ( $\pm 3.5\%$ F.S. for compound pressure) is present. Note that the mode is returned to measurement mode automatically 1 second later. The zero clear range varies by $\pm 1\%$ F.S. due to variation between individual products.	Perform zero-clear operation again after restoring the applied pressure to an atmospheric pressure condition.
Applied pressure error		Supply pressure exceeds the maximum set pressure.	Reset applied pressure to a level within the set pressure range.
		Supply pressure is below the minimum set pressure.	
System error	  	Internal data error	Turn off the power supply and then turn on it again. If the failure cannot be solved, please contact SMC for investigation.

If the error cannot be reset after the above measures are taken, or errors other than above are displayed, please contact SMC.

## Function Details

### G Anti-chattering function (Simple setting mode or F1)

A large bore cylinder or ejector consumes a large volume of air in operation and may experience a temporary drop in the supply pressure. This function prevents detection of such temporary drops in the supply pressure as an error by changing the delay time setting.

Available delay time settings
1 ms or less, 20 ms, 100 ms, 500 ms, 1000 ms, 2000 ms, 5000 ms

<Principle>

This function averages pressure values measured during the response time set by the user and then compares the average pressure value with the pressure set point value to output the result on the switch.

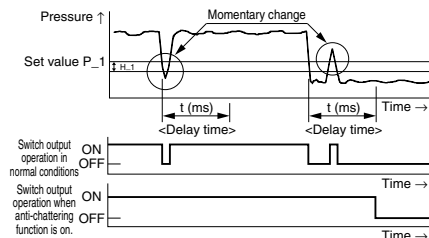

### H Unit selection function (F0)

Display units can be switched with this function.

Smallest settable increment	Display unit	Rated pressure range	MPa	kPa	Pa	kgf/cm <sup>2</sup>	bar	mbar	psi	inHg	mmHg	mmH <sub>2</sub> O
			MPa*1	kPa	Pa	kgf/cm <sup>2</sup>	bar	mbar	psi	inHg	mmHg	mmH <sub>2</sub> O
Applicable SMC pressure sensor	PSE550	0 to 2 kPa		0.001	1			0.01	0.001			0.1
	PSE531	0 to -101 kPa	0.001	0.1		0.001	0.001		0.01	0.1	1	
	PSE541											
	PSE561											
	PSE533	-100 to 100 kPa	0.001	0.1		0.001	0.001		0.02	0.1	1	
	PSE543											
	PSE563											
	PSE573											
	PSE532	0 to 100 kPa	0.001	0.1		0.001	0.001		0.01			
	PSE564	0 to 500 kPa	0.001	1		0.01	0.01		0.1			
PSE574												
PSE530	0 to 1 MPa	0.001	1		0.01	0.01		0.1				
PSE540												
PSE560												
PSE570												
PSE575	0 to 2 MPa	0.001	1		0.01	0.01		0.2				
PSE576	0 to 5 MPa	0.01			0.1	0.1		1				
PSE577	0 to 10 MPa	0.01			0.1	0.1		1				

\*1 The PSE5□1 (vacuum pressure), PSE5□2 (low pressure), and PSE5□3 (compound pressure) will have different setting and display resolution when the unit is set to MPa.

### I Power saving mode (F80)

Power saving mode can be selected.

It shifts to the power saving mode without button operation for 30 seconds.

It is set to the normal mode (Power saving mode is OFF.) when ex-factory.

(During power saving mode, [ECo] will flash in the sub screen and the operation light is ON (only when the switch is ON).)

### J Setting of secret code (F81)

Users can select whether a secret code must be entered to release key lock.

At the time of shipment from the factory, it is set such that the secret code is not required.

ZSE20  
ISE20

ZSE30  
ISE30

ZSE40  
ISE40

ZSE10  
ISE10

ISE70

ZSE80  
ISE80

PS

ISA3

ISA2

ISE35

PSE

IS

ISG

ZSM1

# Options / Connection Examples

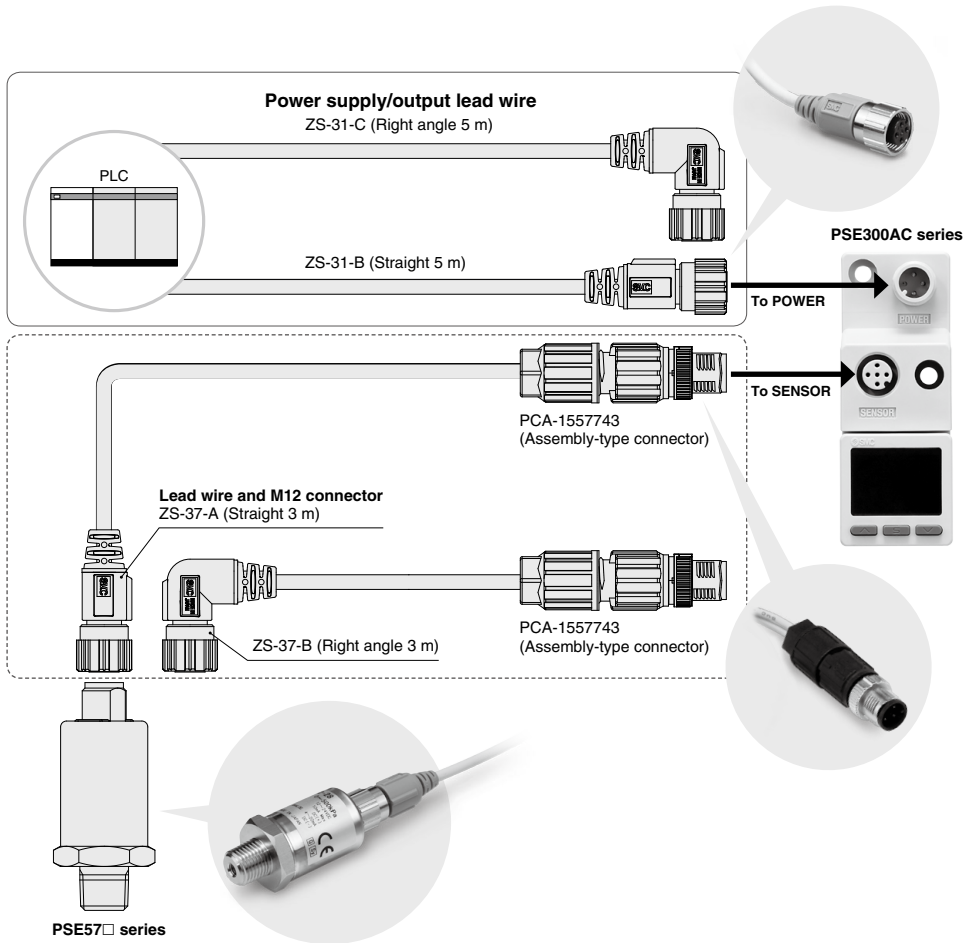

## Lead wire and M12 connector + Assembly-type connector Set part no.

ZS-37-A-X448	Straight 3 m	One lead wire with M12 connector and one assembly type connector are shipped together. (but not assembled)
ZS-37-B-X449	Right angle 3 m	