

SERIES: PSE-3000 | DESCRIPTION: AC-DC HOT-SWAP POWER SUPPLY
FEATURES

- up to 3000 W continuous power
- 80 PLUS Platinum Efficiency
- PoE output isolation; (1500 Vrms to ground)
- high power density - 33.48 W/in³
- PMBus™ communication for monitoring & control
- dual fan forced cooling with speed control
- front to back (-F) and back to front (-B) airflow versions
- power factor correction
- 3.3 Vdc (2A) standby voltage
- redundant (N+1) operation
- blind mate connections for hot-swap
- constant power (CP) mode
- harmonic correction to EN61000-3-2, Class A
- DROOP current sharing
- single I/O connector for AC input, DC output & signals
- remote on/off control
- power good signal
- optional 19" four slot power shelf

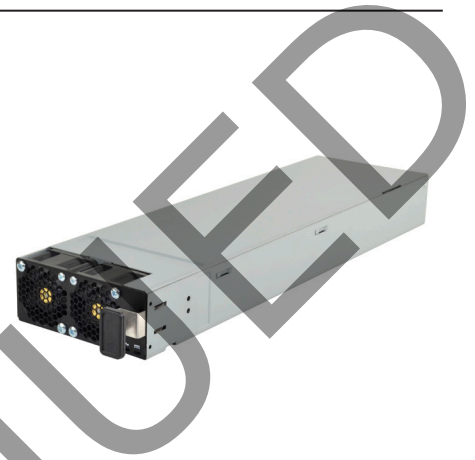

MODEL	output voltage	output current	output power ^{2,3}	ripple and noise ¹	efficiency ⁴
	(Vdc)	max (A)	max (W)	max (mVp-p)	typ (%)
PSE-3000-48-F	48	62.5	3000	480	94
PSE-3000-48-B	48	62.5	3000	480	94
PSE-3000-54-F	54	55.5	3000	540	94
PSE-3000-54-B	54	55.5	3000	540	94

Notes:

1. Measured at 20 MHz bandwidth at an oscilloscope jack on the output with 0.1 μ F ceramic and 10 μ F aluminum electrolytic capacitors.
2. At 90~180 Vac input, maximum of 1500 W.
3. At 180~264 Vac input, maximum of 3000 W.
4. At 230 Vac input, 3000 W. Meets 80 PLUS platinum efficiency requirements.
5. All specifications measured at: Ta=25°C and 220 Vac input voltage unless otherwise specified.

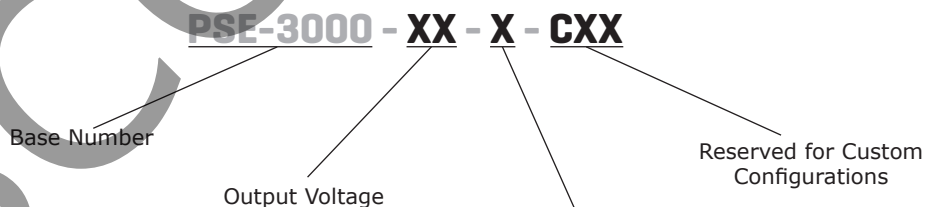
PART NUMBER KEY

Airflow Direction:

F = AC input connector to DC output connector
 B = DC output connector to AC input connector

INPUT

parameter	conditions/description	min	typ	max	units
voltage		90		264	Vac
frequency		47		63	Hz
current	at 90 Vac, 1500 W at 180 Vac, full load			20.2 18.5	Arms Arms
inrush current	at 115 Vac, cold start at 230 Vac, cold start		20 40		A A
leakage current				1.5	mArms
power factor correction	at 230 Vac, full load	0.99			

OUTPUT - V1 (MAIN OUTPUT)

parameter	conditions/description	min	typ	max	units
line regulation			±3		%
load regulation			±3		%
load capacitance				30,000	µF
transient response	50% step load, 1A/µs slew rate, recovery to 1% within 1 ms			3	%
start-up time				5	s
hold-up time	at 230 Vac, full load	12			ms
remote sense	between both output terminals		0.5		V
current share accuracy (Droop)	over 25% to 100% load		±10		%
LED indicator	AC OK: "green" to indicate AC above the lower limit that is required to sustain normal operation DC OK: "green" to indicate module in normal operating condition				

OUTPUT - V2 (STANDBY OUTPUT)

parameter	conditions/description	min	typ	max	units
output voltage			3.3		Vdc
output current		0		2	A
ripple and noise ¹				33	mVp-p
line regulation			±5		%
load regulation			±5		%
load capacitance				1000	µF
transient response	50% step load, 1A/µs slew rate, recovery to 1% within 1 ms			3	%
start-up time				5	s

Notes: 1. Measured at 20 MHz bandwidth at an oscilloscope jack on the output with 0.1 µF ceramic and 10 µF aluminum electrolytic capacitors.

PROTECTIONS

parameter	conditions/description	min	typ	max	units
over voltage protection	V1: latch off V2: latch off	110		60 120	Vdc %
over current protection	V1: constant current inception V2: hiccup			62.5 2.6	A A
over temperature protection	at full load, auto recovery		55		°C

SAFETY & COMPLIANCE

parameter	conditions/description	min	typ	max	units
insulation safety rating / test voltage	input to output, reinforced	3,000			Vrms
	input to chassis, basic	1,500			Vrms
isolation voltage	output to output	1,500			Vrms
	output to chassis	1,500			Vrms
	signals to chassis/ground	1,500			Vdc
	V2 to chassis/ground	100			Vdc
grounding	The main output V1 is "floating" and not referenced to chassis/ground. The output control and status signals are referenced to the V2 output return connection.				
safety approvals	EN60950-1:2006+A11+A1+A12, IEC60950-1:2005+Amd 1, CAN/CSA-C22.2 No.60950-1-07+A1:2011, UL 60950-1:2007 R12.11(NRTL Route), EEC/93/68/LVD, 2006/95/EC LVD				
conducted emissions	FCC 15 Sub Part B, EN55022, Class A: 3dB margin tested with resistive load				
radiated emissions	FCC 15 Sub Part B, EN55022, Class A: 3dB margin tested with resistive load				
harmonic compliance	EN/IEC 61000-3-2:2009, Class A Harmonic Limits Compliance Level: 230 Vac line voltage, 100% output load				
flicker	EN/IEC 61000-3-3:2009 limits as specified in the standard: flicker and voltage fluctuations				
electrostatic discharge	EN/IEC 61000-4-2, ±8 kV operational air discharge, ±8 kV contact discharge: all parameters to remain within limits, test set up to be defined				
RF electro-magnetic field. amplitude modulated	EN/IEC 61000-4-3 80~1000 MHz, 10V/m, 80% AM Modulation (1 kHz): all parameters to remain within limits, test set up to be defined				
immunity to fast transients	EN/IEC 61000-4-4 Power lines: ±2 kV: all parameters to remain within limits, test set up to be defined				
surges (mains)	EN/IEC 61000-4-5 ±1 kV line to line, ±2 kV line to earth, Criteria A: all parameters to remain within limits, test set up to be defined				
RF continuous conducted	EN/IEC 61000-4-6 150 kHz~80 MHz 3Vrms 80% AM (1 kHz), Criteria A: all parameters to remain within limits, test set up to be defined				
voltage dips/interruptions	IEC 61000-4-11 30% reduction for 10 ms, 60% reduction for 100 ms: Reset is permitted must be selfrecovering. Additionally, the PSU shall not latch up during any brownout condition.				
MTBF	as per Telcordia SR-332, Issue 2, Sept 2006 component stress method at Ta=25°C	916,000			hours
RoHS	2011/65/EU				
WEEE	2012/19/EU				

ENVIRONMENTAL

parameter	conditions/description	min	typ	max	units
operating temperature	full load, no derating	0		50	°C
storage temperature	non-condensing	-40		70	°C
operating humidity	non-condensing	10		90	%
storage humidity		5		90	%

ENVIRONMENTAL (CONTINUED)

parameter	conditions/description	min	typ	max	units
acoustic	ISO 7779-1999			60	dB LpAm
cold ¹	IEC 68 Part 2 – 1: at -10°C minimum for 4 hours				
dry heat	IEC 68 Part 2 – 2: at 50°C minimum for 4 hours				
damp heat, cyclic	IEC 68 Part 2 – 30: at 20~45°C, 30~95 %RH				
low air pressure (operating)	IEC 68 Part 2 – 13: at 10,000 feet, 697 mbar				
vibration (sinusoidal)	IEC 68 Part 2 – 6: at 10~58 Hz, 0.075 mm; 58~500 Hz, 10 m/s ² , 1 octave/minute, 10 cycles/ main axis		1		G
shock	IEC 68 Part 2 – 27: at 300 m/s ² , 11 ms, half sine wave 3 shocks/main axis		30		G
bump	IEC 68 Part 2 – 29: at 150 m/s ² , 6 ms, half sine wave 900 bumps/main axis		15		G

Notes: 1. The module shall start up at -10°C, however it is not required that the full specification is achieved until the operational internal temperature has risen to 0°C.

MECHANICAL

parameter	conditions/description	min	typ	max	units
dimensions	14.00 x 4.00 x 1.60 (355.6 x 101.6 x 40.6 mm)				inches
weight			2.01		kg
cooling / airflow	integral fans				
material flammability	UL 94V-0				
AC input	IEC320/C14				
DC output	FCI PwrBlade P/N 51939-661LF mates with FCI P/N 51915-351LF				

MECHANICAL DRAWING

units: inches [mm]
tolerance:
X.XX ±0.02 [0.50]
X.XXX ±0.010 [0.25]

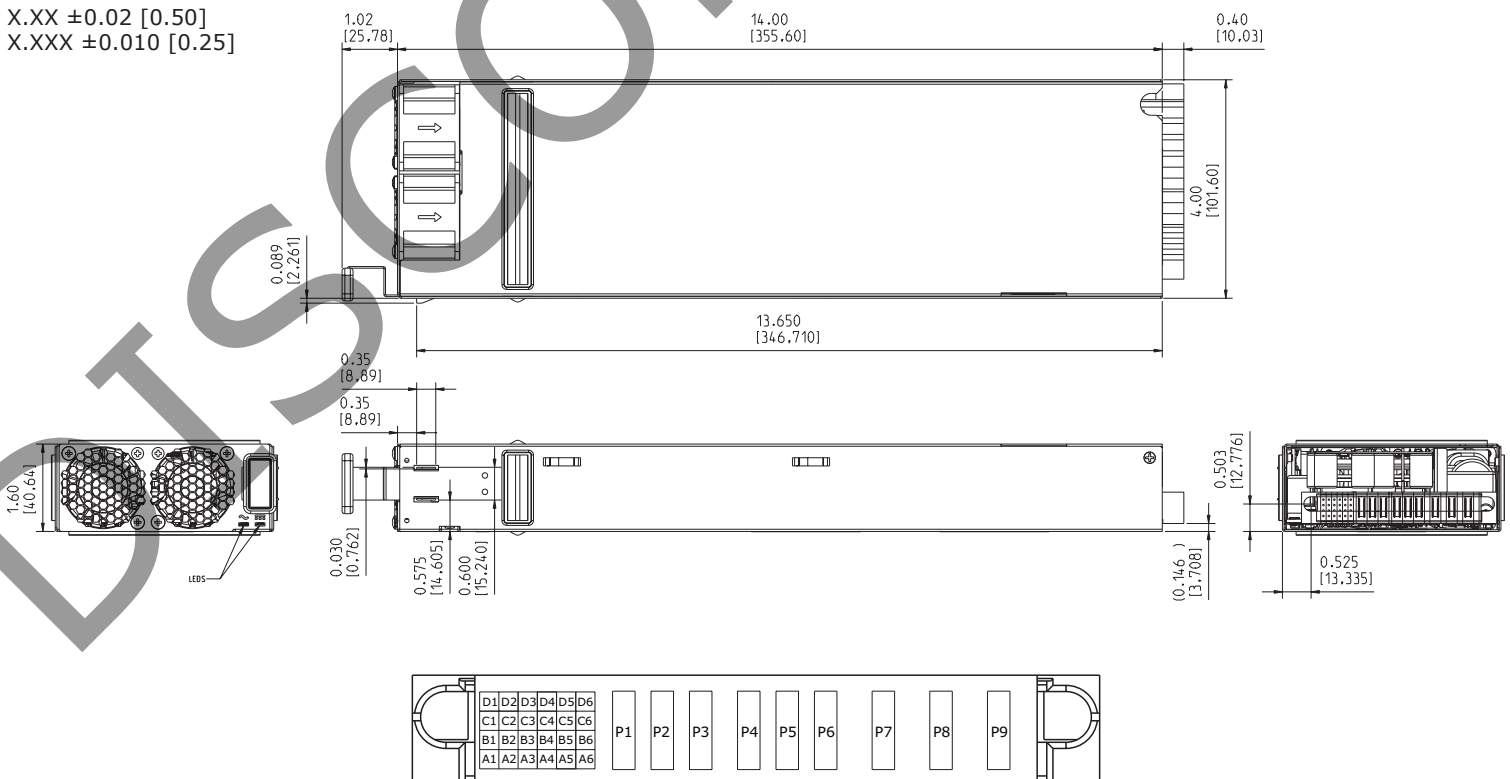

DC PIN ASSIGNMENTS

PIN		FUNCTION	DESCRIPTION	HIGH / LOW LEVEL	Imax	
P1, P2, P3		V (-VE/return)	V1 (-VE) output terminal			
P4, P5, P6		V (+VE)	V1 (+VE) output terminal			
P7		earth/chassis ground	protective/safety earth			
P8		neutral	neutral or AC line#2			
P9		line	hot/AC line#1			
signal pin column "1"	A1	I ² C address A0	I ² C address - LSB			
	B1	I ² C address A1	I ² C address bit			
	C1	I ² C address A2	I ² C address - MSB			
	D1	REMOTE_ON_L	internal pull up to 3.3 V			3.3 mA
			signal pin status	output status		
			open circuit	"off"		
logic "1"			"off"			
		logic "0"	"on"			
signal pin column "2"	A2	DC_OK_L	"L" to indicate DC output is within regulation, there is no internal pull up resistor and it should be provided externally to support VCEO ≤ 20 Vdc, Ic ≤ 5 mA dc	>2.1 V <0.4 V	-5 mA	
	B2	AC_OK_L	"L" to indicate AC above lower limit that is required for sustain normal operation, there is no internal pull up resistor and it should be provided externally to support VCEO ≤ 20 Vdc, Ic ≤ 5 mA dc	>2.1 V <0.4 V	-5 mA	
	C2	PS_PRESENT_L	detects presence of power supply, "low" when inserted, host system to provide pull up resistor capable of sourcing 5 mA	>2.1 V <0.4 V	-5 mA	
	D2	Vstandby (+VE)	V2 (+VE) output terminal			
signal pin column "3"	A3	I ² C/SMBus clock	external 3.32 kΩ pull-up needed to 3.3 V		-3 mA	
	B3	I ² C/SMBus data	external 3.32 kΩ pull-up needed to 3.3 V		-3 mA	
	C3	SMBALERT	communications (SMBus) alert	>2.1 V <0.4 V	-5 mA	
	D3	Vstandby (-VE)	V2 (-VE) output terminal			
signal pin column "4"	A4	n/a	reserved			
	B4	n/a	reserved			
	C4	OTP_OK_L	temperature "OK" signal	>2.1 V <0.4 V	-5 mA	
	D4	n/a	reserved			
signal pin column "5"	A5	Spare/Vpgm	analog VPGM signal			
	B5	n/a	reserved			
	C5	n/a	reserved			
	D5	n/a	reserved			
signal pin column "6"	A6	V1 -VE sense	V1 negative sense connection			
	B6	Ishare	V1 current share option			
	C6	n/a	reserved			
	D6	V1 +VE sense	V1 positive sense connection			

APPLICATION NOTES

Digital Communication Feature Set

The default method of digital communication shall utilize I²C hardware capable of operation at a minimum of 100 kHz clock (SCL) frequency. A mandatory feature of this module is that should either the module be disconnected from the incoming AC source (inserted in to a slot in an unpowered state); the module input fuse(s) fail; or the internal auxiliary supply (which derives the VCC of the I²C equipped device) fail, then any line associated with the I²C bus (SCL; SDA) should be disconnected (effectively tri-stated) from the I²C bus to prevent erroneous operation that may result from this unpowered condition. All I²C lines shall be "clean" and free from excessive spikes and common mode noise and comply with the requirements of the generic standard which defines I²C logic levels.

The I²C hardware should conform to the requirements of the NXP (formerly Philips Semiconductor) Standard: UM10204 I²C Bus Specification and User Manual; Rev 0.3; 19 June 2007.

The rectifier shall be capable of processing commands to monitor & control the rectifier via the digital bus by use of the following protocols:

- CUI's "standard" protocol – this shall be considered the "default" that shall be offered as a standard.
- The PMBus™ (Power Management Bus) Protocol – this shall be considered the "optional" offering.

I²C "Standard" Feature

The following features will be offered as "standard" by the base product:

Vital Product Data (VPD)

This feature shall provide write-protected Vital Product Data (VPD) which shall include the following:

- Revision level
- CUI Date Code and origin of manufacture
- CUI Serial number (from the product label) is the last 5 or 6 maximum numbers, and is padded with zeros to fit the PMBus™ variable as 8 bytes total

Slave Addresses

The product's 7-bit I²C slave address is formed by determining the logic state of the address pins A0, A1 and A2. A pull-up resistor shall be supplied within the product for each address pin. The values of A0, A1 and A2 are set in the backplane of the system. Thus the device can be set to respond to all 7-bit addresses in the range from binary 1011 000 to 1011 111.

The address pins shall be read once the micro-controllers have been initialized. To prevent hot swapping from latching the slave address to a specific slot in the enclosure, the software shall continuously read and update at an interval of 1 s the slave address accordingly.

Bit 7	Bit 6	Bit 5	Bit 4	Bit 3	Bit 2	Bit 1	Bit 0
1	0	1	1	A2	A1	A0	R/W

APPLICATION NOTES (CONTINUED)

Digital Interface

The product is provided with a digital communications interface that is based upon a subset of the SMBus™ & PMBus™ Protocols.

The communication interface is a Two Wire Interface (TWI) using devices hardware compatible with I²C.

The interface is based upon the I²C Protocol developed by Philips Semiconductors (now NXP). Reference to the "I²C Bus Specification and User Manual" UM10204 Rev.03 – 19 June 2007 is recommended.

General Information

Refer to the PMBus™/SMBus specification for details on read/write operations when dealing with Byte, Word or Block process calls. Packet Error Correction (PEC) and Address Resolution Protocol (ARP) are not supported.

If the PMBus™ master tries to read more bytes than the length of the data selected by the command code, the additional bytes will be sent as 0xFF.

The PMBus™ slave device may apply clock stretching by holding the clock line (SCL) low after a command to indicate that it is busy processing data. A master device on the PMBus™ bus may attempt to continue with the communications but must first wait until the clock line is released. Clock stretching times will vary depending on the data being processed and/or if there are any higher priority events occur during the response but shall not exceed 25 ms.

APPLICATION NOTES (CONTINUED)

PMBus™ COMMAND SUBSET

The following is subset of commands (extracted from the “PMBus™ Power System Management Protocol Specification; Part II Command Language; Rev 1.2, 6 September 2010”) and apply on a per module basis, (although certain commands could be applied “globally”). For a full definition of the individual command refer to the above referenced PMBus™ specification.

Opcode (HEX)	Command Name	No. of Bytes	Type	Read / Write	Command Description
01	OPERATION	1	Byte	W	The OPERATION command is used to turn the unit on & off in conjunction with the CONTROL (short; last make, first make pin).
03	CLEAR_FAULTS	0	N/A	W	Clear fault data latched at STATUS_WORD
19	CAPABILITY	1	Byte	R	Follows PMBus™ spec.
78	STATUS_BYTE	1	Byte	R	Lower byte returned from the STATUS_WORD
79	STATUS_WORD	2	Word	R	The command returns two bytes of data relating to the unit fault condition.
88	READ_VIN	2	Word	R	Provides the measured input voltage of the power module. (Divide decimal value by 100)
89	READ_IIN	2	Word	R	Provides the measured input current of the power module. (Divide decimal value by 100)
8B	READ_VOUT	2	Word	R	Provides the measured output voltage of the power module. (Divide decimal value by 100)
8C	READ_IOUT	2	Word	R	Provides the measured output current of the power module. (Divide decimal value by 100)
8D	READ_TEMPERATURE_1	2	Word	R	This command shall return the prevailing internal ambient of the power module, in degrees Celsius.
8E	READ_TEMPERATURE_2	2	Word	R	This command shall return a select component temperature used by the power module, in degrees Celsius.
8F	READ_TEMPERATURE_3	2	Word	R	This command shall return a select component temperature used by the power module, in degrees Celsius.
90	READ_FAN_SPEED_1	2	Word	R	Provides the measured fan speed (RPM) in the power module.
91	READ_FAN_SPEED_2	2	Word	R	Provides the measured fan speed (RPM) in the power module.
96	READ_POUT	2	Word	R	This command shall return the calculated output being delivered by the power module, in Watts. (Divide value by 10)
97	READ_PIN	2	Word	R	This command shall return the calculated input being drawn by the power module, in Watts. (Divide value by 10)
98	PMBus™_REVISION	1	Byte	R	PMBus™ Revision
99	MFR_ID	8	Block	R	The command returns the ASCII string for manufacturer's ID.
9A	MFR_MODEL	12	Block	R	The command returns the ASCII string manufacturer's model.
9B	MFR_REVISION	2	Block	R	The command returns the ASCII string manufacturer's revision (example case "A0").
9C	MFR_LOCATION	8	Block	R	The command returns the ASCII string manufacturer's revision (example case "TORONTO").
9D	MFR_DATE	4	Block	R	The command returns the ASCII string manufacturer's date code (example case "0913").
9E	MFR_SERIAL	8	Block	R	The command returns manufacturers serial number.

APPLICATION NOTES (CONTINUED)

PMBus™ Non-Standard Extended Command Subset

Opcode (HEX)	Command Name	No. of Bytes	Type	Read / Write	Command Description
16	FIRMWARE_REVISION	4	Block	R	Read vendor specific firmware revision (ASCII string). Example case "A100"
17	BUILD	4	Block	R	Read vendor specific Build (ASCII string)
20	AUXILIARY_VOLTAGE	2	Word	R	Provides the measured output auxiliary voltage of the power module. (Divide decimal value by 100)
8D	READ_TEMPERATURE_4	2	Word	R	This command shall return a select component temperature used by the power module, in degrees Celsius.
8E	READ_TEMPERATURE_5	2	Word	R	This command shall return a select component temperature used by the power module, in degrees Celsius.

Remote On/Off (PMBus™ Operation Command 0x01)

This command can be used to turn the unit on and off via the PMBus™ interface.

If D1 (REMOTE_ENABLE) is LOW (enabled) then the PMBus™ Remote On/Off function can turn the unit off and on. If D1 (REMOTE_ENABLE) is HIGH (disabled) then the PMBus™ Remote On/Off function cannot turn the unit on or off and can be ignored.

The bit encoding of the data byte of the command is as follows.

Bits [7:6]	Bits [5:4]	Bits [3:2]	Bits [1:0]	Unit State
00	XX	XX	XX	Off
01	XX	XX	XX	Off
10	00	XX	XX	On
10	01	00	XX	No change
10	01	11	XX	No change
10	01	01	XX	On
10	01	10	XX	On
10	10	01	XX	On
10	10	10	XX	On
10	10	11	XX	No change
10	11	XX	XX	No change
11	XX	XX	XX	No change

DEMO BOARD

Accessories		
Description	CUI Part Number	Vendor/Part Number
Demo Board ¹	01T-152501-1	
DC Output Mating Connector	22P-S00061-4	FCI 51915-351LF
I ² C dongle ²		Microchip DV164122
Demo Board AC power cord ³		CNC Tech 800-12-32D-BL-0003F

- Notes:
- This demo board is intended for user connection to evaluate the power supply in the laboratory by qualified personnel. Please take necessary safety precautions during product evaluation.
 - The PICKit Serial Analyzer is a USB-based tool used to direct communication between a PC and an external serial device. The kit comes complete with hardware (supporting I²C™, SMBus, SPI and USART protocols), an easy-to-use GUI (to configure and display communications) and a target demonstration board for out-of-the-box functionality. http://www.microchip.com/stellent/idcplg?IdcService=SS_GET_PAGE&nodeId=1406&dDocName=en028600
 - For North American use only

Demo Board Power Connections	
J1	+48V Output
J2	48V Return
J9	+ Standby Output
J8	Standby Output Return

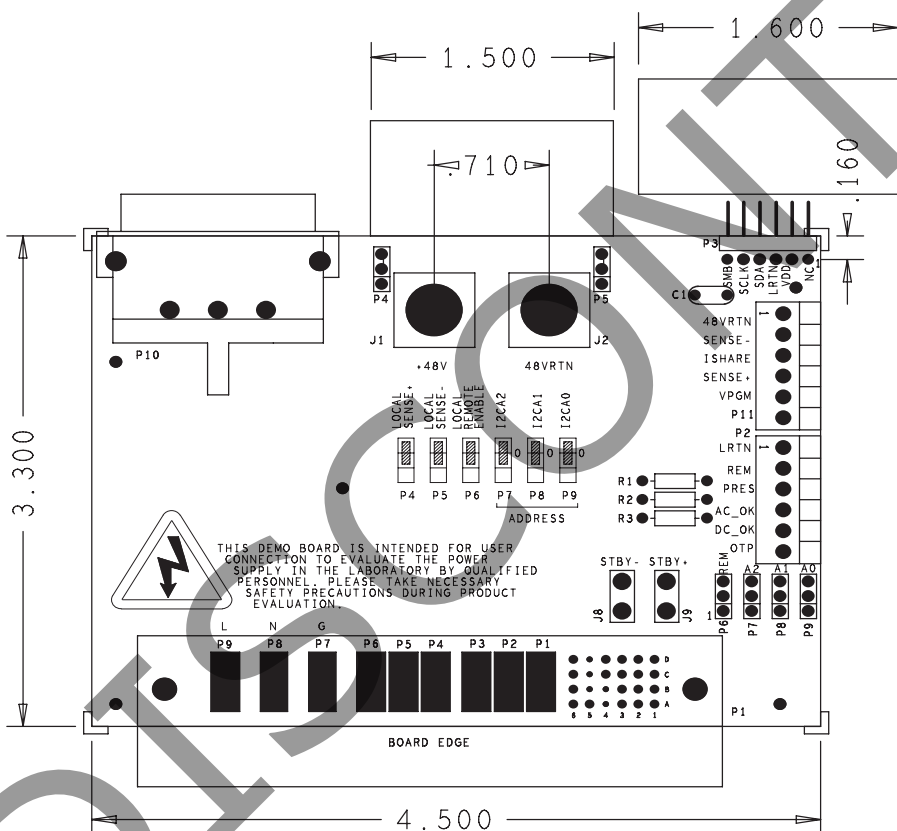

Demo Board Connections/Settings	
P1	AC & DC Mating Connector
P2	Control & Status Signals
1	Logical Return
2	Remote ON (override by P6)
3	Present
4	AC_OK
5	DC_OK
6	OTP
P3	I ² C Dongle Connection
1	SMB
2	SCL
3	SDA
4	Logical Return
5	VDD
6	NC
P4	Jumper to Local Sense+, remove jumper for remote sense
P5	Jumper to Local Sense-, remove jumper for remote sense
P6	Jumper to ON, remove jumper for Remote ON/OFF
P7	Jumper to set I ² C A2 = 0, remove jumper to set address by host
P8	Jumper to set I ² C A1 = 0, remove jumper to set address by host
P9	Jumper to set I ² C A0 = 0, remove jumper to set address by host
P11	Control & Status Signals
1	48V Return
2	SENSE- (override by P5)
3	ISHARE (optional force sharing)
4	SENSE+ (override by P4)
5	Vpgm
6	NC

POWER SHELF

Power Shelf Model Number	Power Module Model Number	Airflow Direction	Shelf Power		Standby Output	IEC Inlet Type
			110 Vin	220 Vin		
PPR-1U	PSE-3000-48-F or PSE-3000-54-F	Front to Back	6,000 W	12,000 W	All Parallel, dual polarity terminal block	C22
PPR-1U-A	PSE-3000-48-F or PSE-3000-54-F	Front to Back	6,000 W	12,000 W	A & B Feed, dual polarity terminal block	C22
PPR-1U-B	PSE-3000-48-B or PSE-3000-54-B	Back to Front	5,400 W	12,000 W	All Parallel, dual polarity terminal block	C20
PPR-1U-C	PSE-3000-48-B or PSE-3000-54-B	Back to Front	5,400 W	12,000 W	A & B Feed, dual polarity terminal block	C20
PPR-1U-D	PSE-3000-48-F or PSE-3000-54-F	Front to Back	6,000 W	12,000 W	All Parallel, single polarity terminal block	C22
PPR-1U-E	PSE-3000-48-B or PSE-3000-54-B	Back to Front	5,400 W	12,000 W	All Parallel, single polarity terminal block	C20

PPR-1U, PPR-1U-A, PPR-1U-D - FRONT TO BACK AIRFLOW

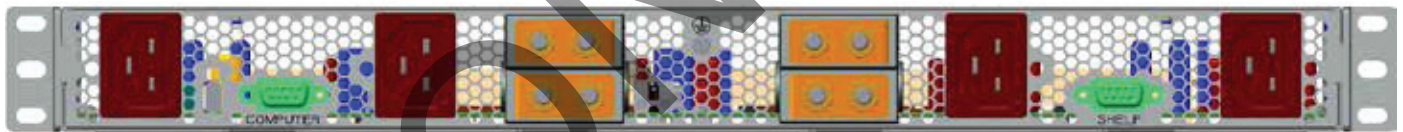

PPR-1U-B, PPR-1U-C, PPR-1U-E - BACK TO FRONT AIRFLOW



POWER SHELF (CONTINUED)

PPR-1U, PPR-1U-A, PPR-1U-D - FRONT TO BACK AIRFLOW

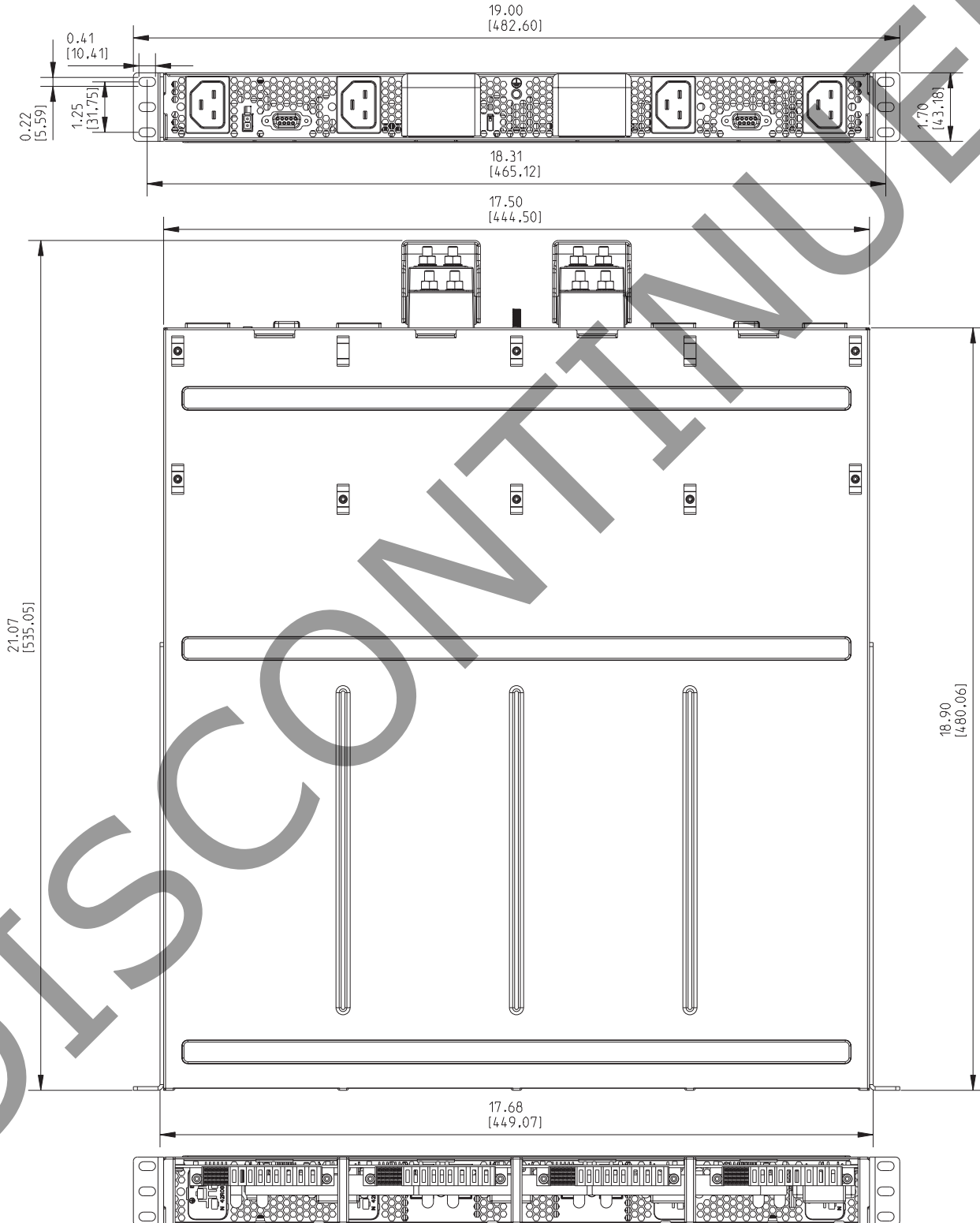

POWER SHELF (CONTINUED)

PPR-1U-B, PPR-1U-C, PPR-1U-E - BACK TO FRONT AIRFLOW

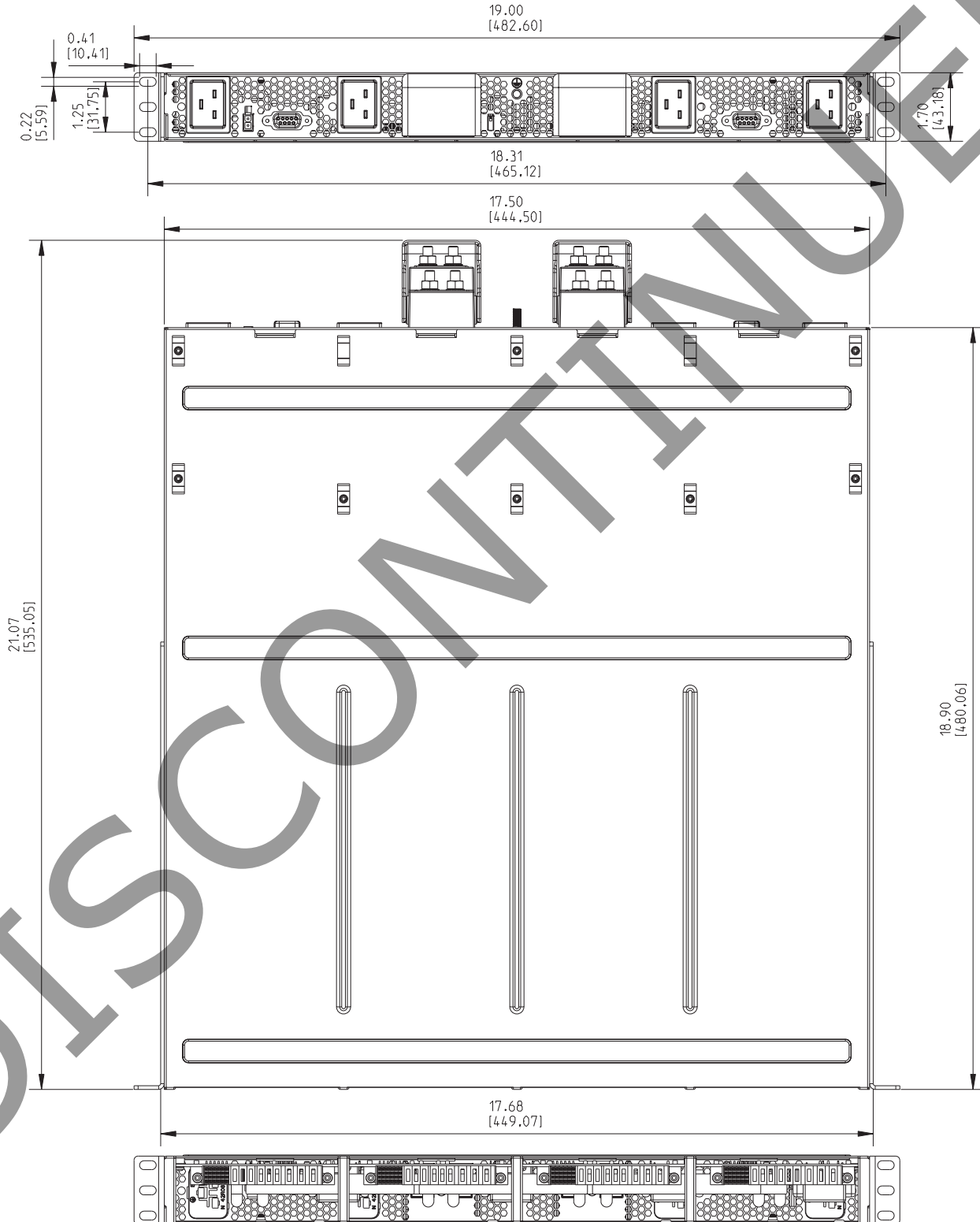

POWER SHELF (CONTINUED)

PPR-1U & PPR-1U-B Output Terminal Block Configuration

All 4 power modules wired in parallel inside the power shelf, 12 kW available from each output

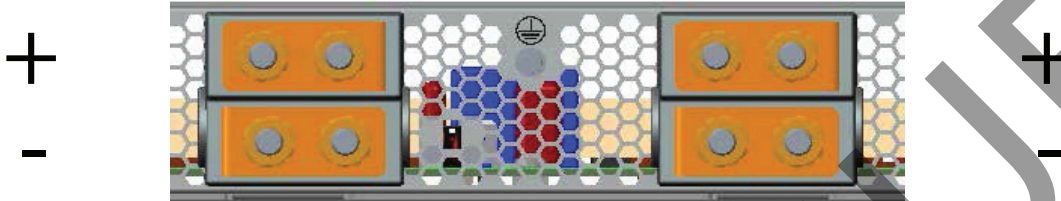

PPR-1U-A & PPR-1U-C Output Terminal Block Configuration

Each terminal block wired to 2 power modules, 6 kW available from each output

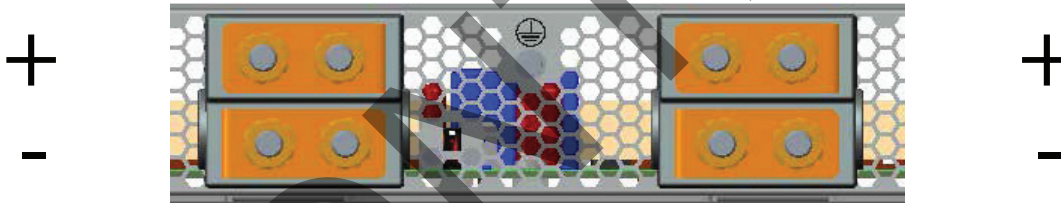

PPR-1U-D & PPR-1U-E Output Terminal Block Configuration

All 4 power modules wired in parallel inside the power shelf, one single output through both terminal block, 12 kW available from each output

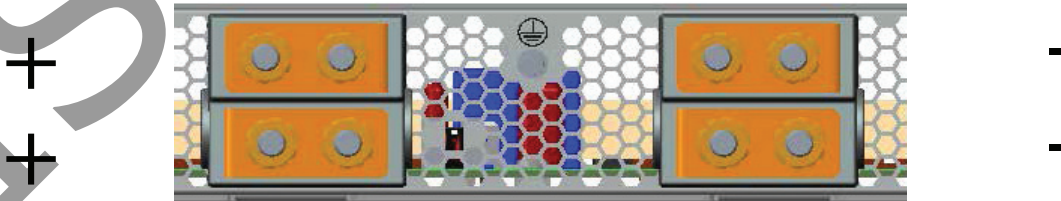

ASSEMBLY INSTRUCTIONS

Chassis Grounding

A ground stud is provided at the rear of the power shelf as shown below. Earth ground stud nut #10-32 to be torqued 16 to 19 in-lbs typical.

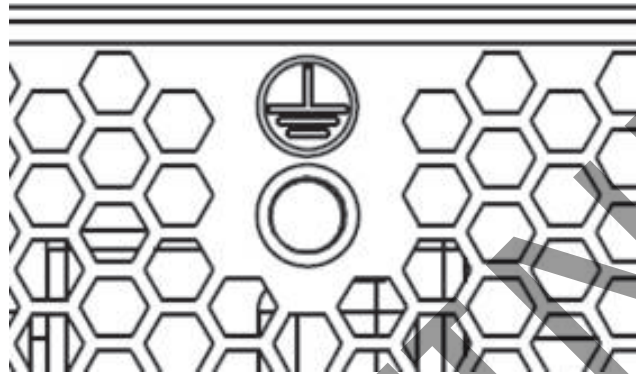

Bracket Attachment

The mounting brackets are factory attached in the flush position. The mounting brackets can be repositioned by customer, however the #6-32 mounting screws to be reattached with typical torque of 6 to 8 in-lbs.

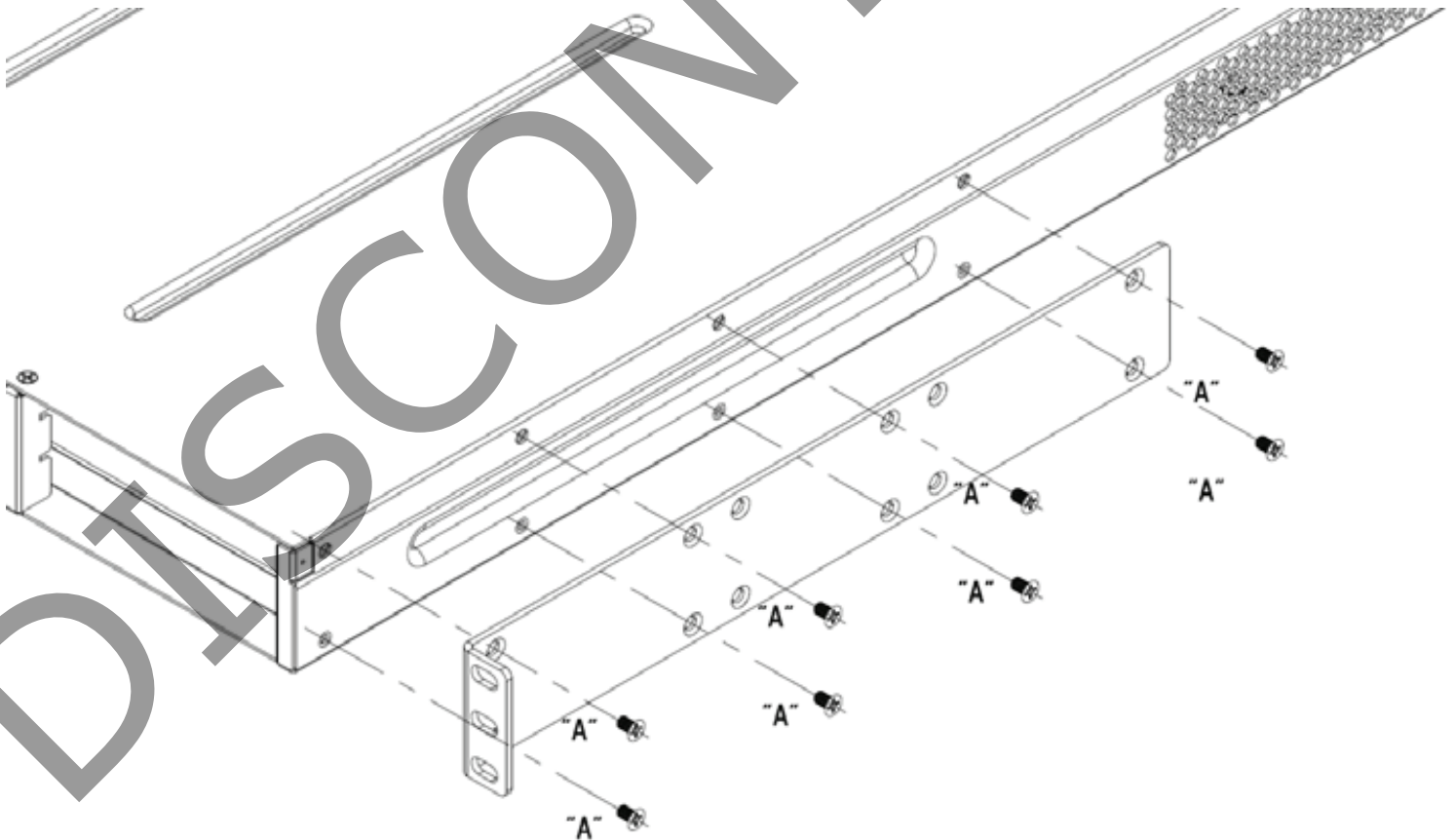

ASSEMBLY INSTRUCTIONS (CONTINUED)

Output Cable Connection

The Output and Return Cables (#2 AWG wire on 1/4" stud - not provided) to be A ground stud is provided at the rear of the power shelf as shown below.

Earth ground stud nut #10-32 to be torqued 16 to 19 in-lbs typical.

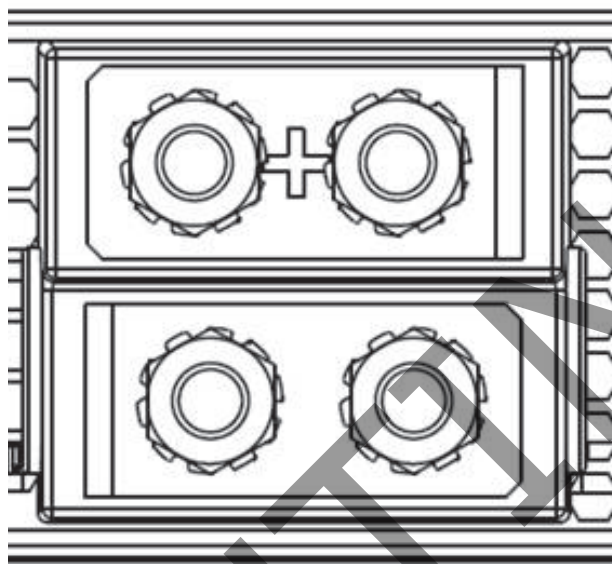

AC Line Cord Connection

The power shelf is not shipped with AC line cords and the customer is responsible to provide its own AC line cords to meet the respective local electrical code requirements.

ASSEMBLY INSTRUCTIONS (CONTINUED)

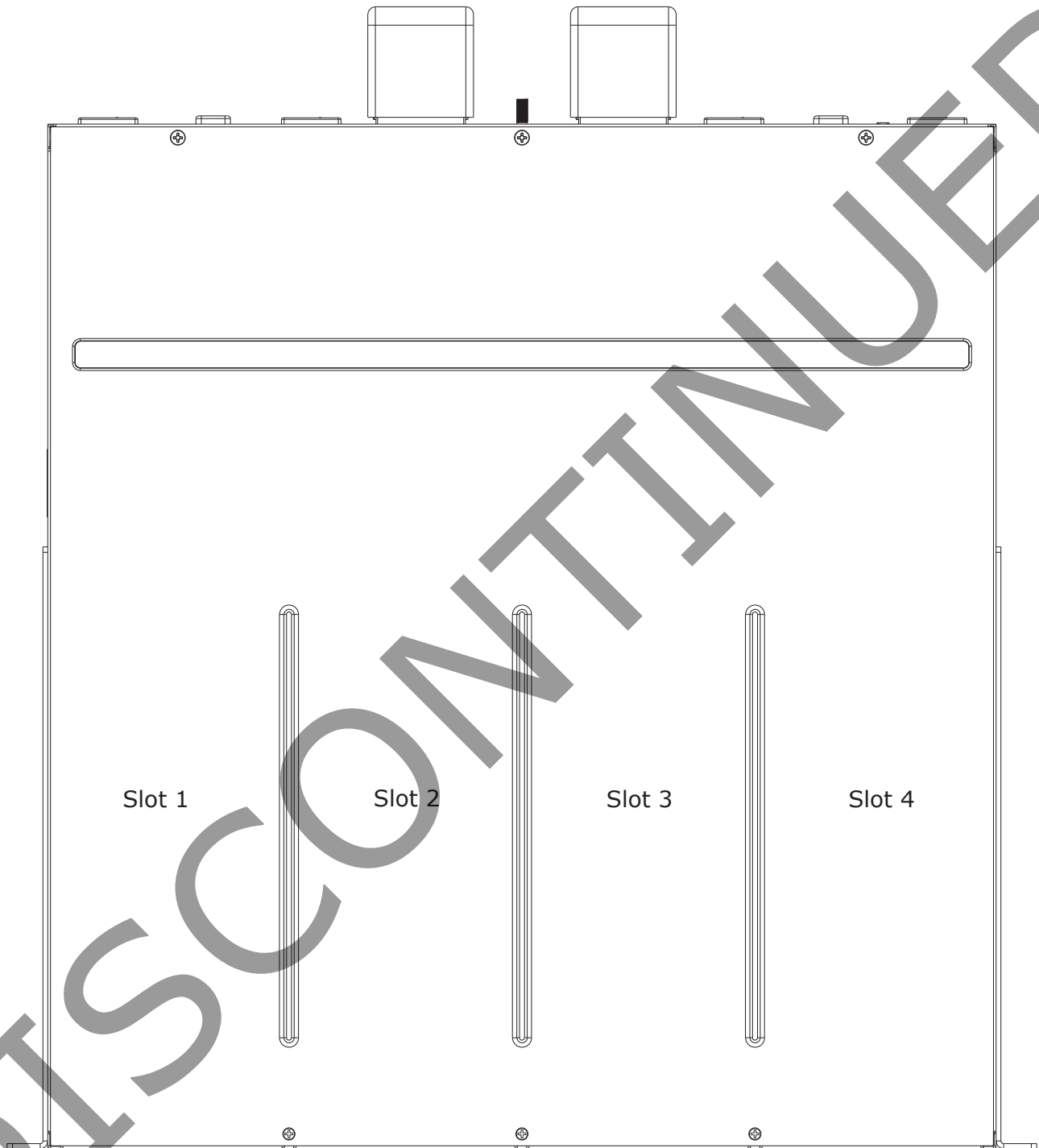

A2 Address Switch	Address			
	Slot 1	Slot 2	Slot 3	Slot 4
DOWN	000	001	010	011
UP	100	101	110	111

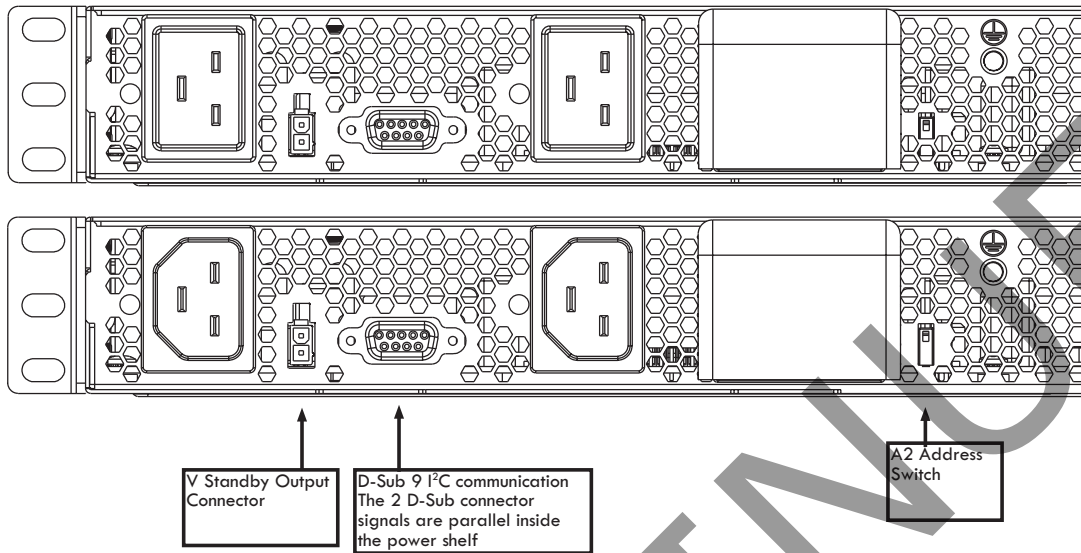
ASSEMBLY INSTRUCTIONS (CONTINUED)**V Standby Output Connector, Mating Connector Molex 39-01-2020, terminals 39-00-0038**

Connector - Pin#	Signal Name	Function
1 (lower position)	+3.3 STANDBY	+3.3 VDC +VE Output
2 (upper position)	+3.3 STANDBY RTN	+3.3 VDC -VE Output

System Interface Connection	D sub 9 pin (female)	System to Shelf	Shelf to Shelf
SDA	1	Yes	Yes
SCL	2	Yes	Yes
Not used	3		
Vpgm	4	Yes	Yes
Vpgm Return	5	Yes	Yes
Digital Return	6	Yes	Yes
SMB Alert	7	Yes	Yes
Not used	8		
I-Share	9	Yes	Yes

A2 Address Switch, UP position for "1", DOWN position for "0"

Accessories		
Description	CUI Part Number	Vendor/Part Number
D-Sub 9 male to male cable		Assmann WSW Components AK174-3
Vstandby Output Mating Connector		Molex 39-01-2020
I ² C dongle ¹		Microchip DV164122
I ² C dongle to D sub 9 cable	014-157401-4	

Notes: 1. The PICKit Serial Analyzer is an USB-based tool used to direct communication between a PC and an external serial device. The kit comes complete with hardware (supporting I²C™, SMBus, SPI and USART protocols), an easy-to-use GUI (to configure and display communications) and a target demonstration board for out-of-the-box functionality.

REVISION HISTORY

rev.	description	date
1.0	initial release	05/07/2015
1.01	updated datasheet	06/11/2015
1.02	updated datasheet	07/22/2015

The revision history provided is for informational purposes only and is believed to be accurate.



Headquarters
20050 SW 112th Ave.
Tualatin, OR 97062
800.275.4899

Fax 503.612.2383
cui.com
techsupport@cui.com

CUI offers a two (2) year limited warranty. Complete warranty information is listed on our website.

CUI reserves the right to make changes to the product at any time without notice. Information provided by CUI is believed to be accurate and reliable. However, no responsibility is assumed by CUI for its use, nor for any infringements of patents or other rights of third parties which may result from its use.

CUI products are not authorized or warranted for use as critical components in equipment that requires an extremely high level of reliability. A critical component is any component of a life support device or system whose failure to perform can be reasonably expected to cause the failure of the life support device or system, or to affect its safety or effectiveness.