

Base Mounting and Bulkhead

BASE MOUNTING

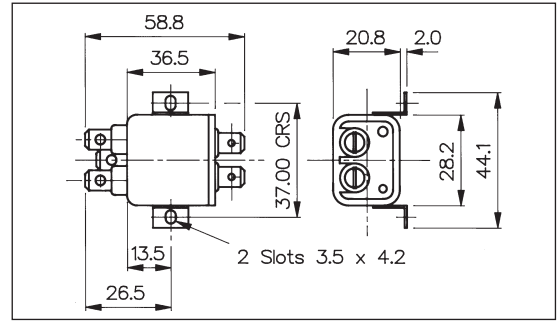

- 1, 3, 6 or 10 Amp Current Rating
- 3 Alternative Circuits
- Optional Additional Components
- 2.8 or 6.3mm tabs



BULKHEAD MOUNTING



- 1, 3, 6 or 10 Amp Current Rating
- 3 Alternative Circuits
- Optional Additional Components
- 2.8 or 6.3mm tabs

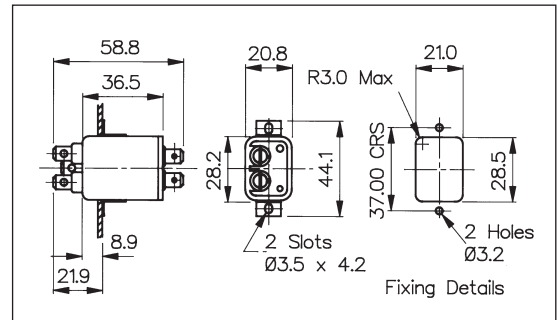

PS02 or PS03/Axx xx /xx

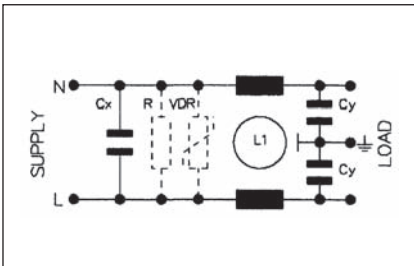

Series	Rating	L/C Circuit	Additional Components	Tag Type and Configuration
PS02/A	01 = 1A	1 = Version 1	0 = None	28 = 2.8mm
PS03/A	03 = 3A	2 = Version 2	1 = Bleed (R) Resistor	63 = 6.3mm tabs
	06 = 6A	3 = Version 3	2 = Surge (VDR) Protection	
	10 = 10A		3 = "R" plus "VDR"	

Specification	PS02/Axxxx/xx	PS03/Axxxx/xx	Part No. Example
Max. Working Voltage:	250V a.c. 50-400Hz	250V a.c. 50-400Hz	PS02/A0311/28 = PS02 series, standard base mounting filter, rated at 3 amperes. L/C circuit version 1, i.e. L1 = 2 x 0.75mH, Cx = 15nF, Cy = 2 x 2.2nF. with bleed resistor fitted, with 2.8mm tabs.
Earth Leakage Current:	<0.35mA (250V, 50Hz)	<0.35mA (250V, 50Hz)	
Temperature Range:	-25°C to +85°C	-25°C to +85°C	
Max. Ambient Temp.: (@ Full Load)	40°C (derate linearly to 0A @ 85°C)	40°C (derate linearly to 0A @ 85°C)	
Test Voltage:	2700V d.c. 2 secs. Lines to Earth 1100V d.c. 2 secs. Live to Neutral	2700V d.c. 2 secs. Lines to Earth 1100V d.c. 2 secs. Live to Neutral	
Approvals:			
	Compliant	Compliant	

IEC CONNECTORS

Rating & Version Table
PS02/Axxxx/xx & PS03/Axxxx/xx

Rating	Version	L1	Cx	Cy
1 AMP	1	2 x 2.8mH	1 x 15nF	2 x 2.2nF
"	2	2 x 10mH	1 x 15nF	2 x 2.2nF
"	3	2 x 10mH	1 x 47nF	2 x 2.2nF
3 AMP	1	2 x 0.75mH	1 x 15nF	2 x 2.2nF
"	2	2 x 1.8mH	1 x 15nF	2 x 2.2nF
"	3	2 x 1.8mH	1 x 47nF	2 x 2.2nF
6 AMP	1	2 x 0.3mH	1 x 15nF	2 x 2.2nF
"	2	2 x 0.7mH	1 x 15nF	2 x 2.2nF
"	3	2 x 0.7mH	1 x 47nF	2 x 2.2nF
10 AMP	1	2 x 0.17mH	1 x 15nF	2 x 2.2nF
"	2	2 x 0.35mH	1 x 15nF	2 x 2.2nF
"	3	2 x 0.17mH	1 x 47nF	2 x 2.2nF

Version 1

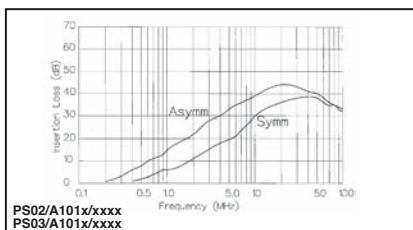
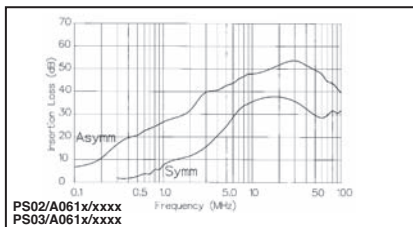
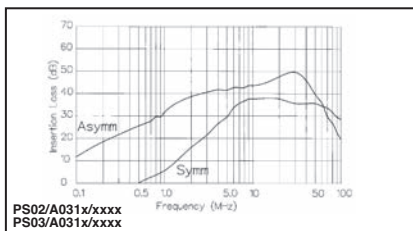
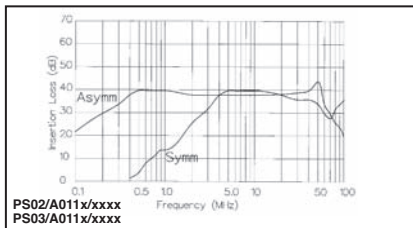

Version 2

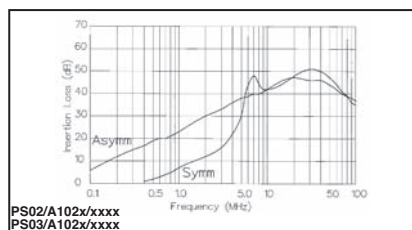
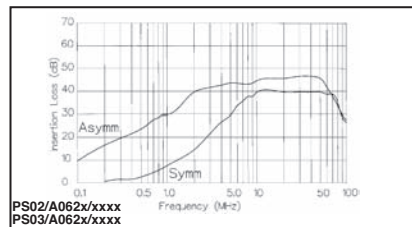
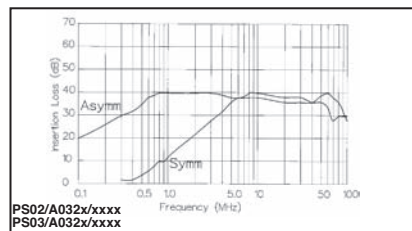
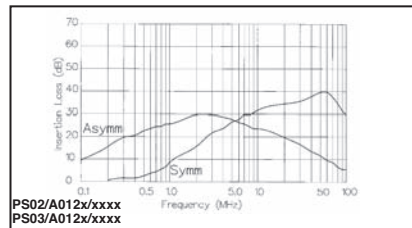

Version 3

