

CP Clare Company Overview**1****Product Selection Guide****2****Advanced Magnetic Products****3****Circuit Products****4****Reed Relay Products****5****Switch and Sensor Products****6****Surge Protection Products****7****Glossary****8****Index by Part Number****9**

Section 1 – CP Clare Company Overview

Overview 1

Section 2 – Product Selection Guide

Advanced Magnetic Products 3
 Circuit Products 9
 Reed Relay Products 16
 Switch and Sensor Products 24
 Surge Protection Products 25

Section 3 – Advanced Magnetic Products

Introduction 31

Modem Isolation Transformers/Couplers

MIT-101 – V.32 9.6k American Wet Coupler 32
 MIT-101V – V.32 9.6k American Wet Coupler with 5kV transient survival 34
 MIT-115 – Enhanced V.32 9.6k American Wet Coupler 36
 MIT-115V – Enhanced V.32 9.6k American Wet Coupler with 5kV transient survival 38
 MIT-125 – V.32 14.4k American Dry Coupler often adapted to V.34+ 33.6 and V.90 56k 40
 MIT-131 – Low-distortion V.34+ 33.6k American Dry coupler adaptable to V.90 56k 42
 MIT-139 – Very low-distortion V.34+ 33.6k American Dry coupler 44
 MIT-179 – Very low-distortion V.34+ 33.6k American Dry coupler cost-reduced 46
 MIT-205 – V.32bis 14.4k American Wet coupler adaptable to V.34+ 33.6k 48
 MIT-262 – V.90 56k American Dry coupler 50
 MIT-372 – V.90 56k American Dry coupler featuring low insertion loss 52
 MIT-538 – V.32bis 14.4k American Dry coupler featuring low insertion loss 54
 MIT-600 – V.32bis 9.6k American Wet coupler – small size 56
 MIT-3262 – Low distortion V.90 56k American Dry coupler – value engineered 58

Encapsulated Modem Isolation Transformers/Couplers

EMIT-101 – V.32 9.6k American Wet coupler with 4kV I/O isolation 60
 EMIT-600 – V.32 9.6k International Wet coupler for voice or modem 62
 EMIT-1200 – V.32 14.4k International Dry coupler 64
 EMIT-2001 – Low-distortion V.34+ 33.6k International Dry coupler 66
 EMIT-2020 – V.90 56k International Dry coupler “drop-in” upgrade from V.34+ 33.6k 68
 EMIT-3020 – Low-distortion V.90 56k International Dry coupler 70

Surface Mount Modem Isolation Transformers/Couplers

SMIT-204X – V.32bis 14.4k American Dry coupler for SMT or PCMCIA 72
 SMIT-304X – V.34+ 33.6k American Dry coupler for SMT or PCMCIA 74
 SMIT-314 – V.34+ 33.6k International Dry coupler for SMT or PCMCIA 76
 SMIT-2393 – Enhanced V.34+ 33.6 International Dry coupler for SMT or PCMCIA 78
 SMIT-2412 – V.34+ 33.6k American Dry coupler for PCMCIA – ultra small 80

Encapsulated Surface-Mount Modem Isolation Transformers/Couplers

ESMIT-100 – V.32bis 14.4k International Dry coupler for SMT or small footprint 82
 ESMIT-300 – V.34+ 33.6k International Dry coupler for SMT or small footprint 84

Advanced Magnetic Products Application Notes 86

Section 4 – Circuit Products

Single Pole OptoMOS® Relays

Product Introduction.....	91
LCA100 – 1-Form-A, 350V, 120mA, 25Ω	92
LCA110 – 1-Form-A, 350V, 120mA, 35Ω	98
XCA170 – 1-Form-A, 350V, 120mA, 50Ω	104
LCA120 – 1-Form-A, 250V,170mA, 20Ω	108
LCA125 – 1-Form-A, 300V,170mA, 16Ω	114
LCA126 – 1-Form-A, 250V,170mA, 15Ω	120
LCA127 – 1-Form-A, 250V, 200mA, 10Ω	124
LCA710 – 1-Form-A, 60V,1A, 0.5Ω	130
LCB110 – 1-Form-B, 350V,120mA, 35Ω	134
LCB120 – 1-Form-B, 250V, 170mA, 20Ω	138
LCB126 – 1-Form-B, 250V, 170mA, 15Ω	142
LCB127 – 1-Form-B, 250V, 200mA, 10Ω	146
OMA160 – 1-Form-A, 250V, 50mA, 100Ω	150
PLA110 – 1-Form-A, 400V,150mA, 22Ω	154
PLA140 – 1-Form-A, 400V,250mA, 8Ω	160
PLA160 – 1-Form-A, 300V, 50mA,100Ω	164

Dual Pole OptoMOS® Relays

Product Introduction.....	168
LAA110 – 2-Form-A, 350V, 120mA, 35Ω	169
XAA170 – 2-Form-A, 350V, 120mA, 50Ω	175
LAA120 – 2-Form-A, 250V, 170mA, 20Ω	179
LAA125 – 2-Form-A, 300V, 170mA, 16Ω	185
LAA126 – 2-Form-A, 250V, 170mA, 15Ω	191
LAA127 – 2-Form-A, 250V, 200mA, 10Ω	195
LBA110 – 1-Form-A/B, 350V, 120mA, 35Ω	201
XBA170 – 1-Form-A/B, 350V, 120mA, 50Ω	210
LBA120 – 1-Form-A/B, 250V, 170mA, 20Ω	215
LBA126 – 1-Form-A/B, 250V, 170mA, 15Ω	224
LBA127 – 1-Form-A/B, 250V, 200mA, 10Ω	230
LBB110 – 2-Form-B, 350V, 120mA, 35Ω	239
XBB170 – 2-Form-B, 350V, 120mA, 50Ω	243
LBB120 – 2-Form-B, 250V, 170mA, 20Ω	247
LBB126 – 2-Form-B, 250V, 170mA, 15Ω	251
LBB127 – 2-Form-B, 250V, 200mA, 10Ω	255
LCC110 – 1-Form-C, 350V, 120mA, 35Ω	259
LCC120 – 1-Form-C, 250V, 170mA, 20Ω	264
OAA160 – 2-Form-A, 250V, 50mA, 100Ω	269
PAA110 – 2-Form-A, 400V, 150mA, 22Ω	273
PAA140 – 2-Form-A, 400V, 250mA, 8Ω	279

Multifunction Telecom Switches

Product Introduction.....	283
TS112 – 1-Form-A, 350V, 120mA, 20Ω, hookswitch relay and optocoupler	284
TS117 – 1-Form-A, 350V, 120mA, 35Ω, hookswitch relay and optocoupler	288
XS170 – 1-Form-A, 350V, 120mA, 50Ω, hookswitch relay and optocoupler	294

TS118 – 1-Form-B, 350V, 120mA, 35Ω, hookswitch relay and optocoupler	298
TS120 – 1-Form-A, 350V, 120mA, 35Ω, hookswitch relay and optocoupler (Darlington)	302
TS122 – 1-Form-A, 250V, 170mA, 20Ω, hookswitch relay and optocoupler	306
TS190 – 1-Form-A, 400V, 150mA, 22Ω, hookswitch relay and optocoupler	310
Multifunction Integrated Products	
Product Introduction	316
ITC117P – Integrated Telecom Circuit; full-wave ring detection	317
ITC135P – Integrated Telecom Circuit; half-wave ring detection	317
ITC137P – Integrated Telecom Circuits; full-wave ring detection	317
IAA110P – 2-Form-A relays and 1 optocoupler multifunction switch	325
IAB110P – 1-Form-A relay, 1-Form-B relay, and 1 optocoupler multifunction switch	325
IBB110P – 2-Form-B relays and 1 optocoupler	325
IAD110P – 1-Form-A relay and 2 optocouplers	325
IAA170P – 2-Form-A relays and 1 optocoupler multifunction switch	338
IAD170P – 1-Form-A relay and 2 optocouplers	338
PLCA110 – 1-Form-A, 350V,120mA, 35Ω relay with surge protection	345
Linear Optocouplers and Linear Isolation Amplifiers	
Product Introduction	349
LOC110 – Single linear optocoupler	350
LOC111 – Single linear optocoupler	350
LOC112 – Single linear optocoupler	350
LOC210 – Dual linear optocoupler	353
LOC211 – Dual linear optocoupler	353
LIA100 – Linear Isolation Amplifier	356
LIA101 – Linear Isolation Amplifier	356
DAA Modules (Cybergate™ Series)	
Product Introduction	360
CYG20xx- Data Access Arrangement for use in USA, Canada, Japan and the Far East (28.8kbps, ring detect, hookswitch, and Surge Protection)	361
CYG21xx – European Data Access Arrangement (Designed to meet PTT regulations in 15 countries)	366
CYG2217 – Data Access Arrangement for use in USA, Canada, Japan, and the Far East (Built-in 2-4 wire converter)	370
CYG2911 – Data Access Arrangement for use in USA and Canada (Parallel phone off-hook signaling)	374
Solid State Current Sensors	
Product Introduction	377
LDA100 – Bi-directional optocoupler with single transistor output	378
LDA101 – Uni-directional optocoupler with single transistor output	378
LDA110 – Bi-directional optocoupler with Darlington transistor output	378
LDA111 – Uni-directional optocoupler with Darlington transistor output	378
LDA200 – Dual Bi-directional optocoupler with single transistor output	381
LDA201 – Dual Uni-directional optocoupler with single transistor output	381
LDA210 – Dual Bi-directional optocoupler with Darlington transistor output	381
LDA211 – Dual Uni-directional optocoupler with Darlington transistor output	381

TABLE OF CONTENTS

Hybrid Circuits

Product Introduction	384
PDxx01 – Zero Cross Circuitry, Dual Power SCR Outputs (1 Amp), AC Solid State DIP Relay	385
PSxx01 – Zero Cross Circuitry, Dual Power SCR Outputs (1 Amp), AC Solid State SIP Relay	388
PM12xx – Zero Cross Circuitry, Dual Power SCR Outputs (0.5 Amp), AC Solid State 6 pin DIP Relay	391
FDA215 – Mosfet Driver	394

Mechanical Dimensions	396
------------------------------------	------------

Circuit Products Application Notes

FCC Part 68	402
Current Limiting	403
Linear Optocouplers	404
Variable Speed Controllers	416
Medical Applications	418
Isolated Converters	419
PLCA-110 Solid State Relay and Surge Arrester	420
PLA160	423
TS117 Telecom Switch	426
ITC117P Integrated Telecom Circuit	427
Cybergate™ 20xx Series	430
Cybergate™ 21xx Series	437
Technical Notes	444

Section 5 – Reed Relay Products

Introduction	449
--------------------	-----

1"x0.1" Grid Relays

MRB	451
922A	451

ATE Series Reed Relays

ATE11A – 1-Form-A, E/S Shield	459
ATE21A – 1-Form-A, Coaxial Shield	459
ATE31C – 1-Form-C, Dry Reed	459
ATE41A – 1-Form-A, High Reliability	459
ATE61A – 1-Form-A, High Voltage	459
ATE71A – 1-Form-A, 500Ω Coil Resistance	459

CUP Series Reed Relays

CUPC – Metal cover, no encapsulation	464
CUPE – Plastic cover, fully sealed	464
CUPP – Metal cover, fully sealed	464
CUPV – High Input/Output Isolation	464

DIP Series Reed Relay

DIP31C – 1-Form-C, standard ruthenium contact	471
DIP41A – 1-Form-A, Mini-DYAD™ ruthenium contact	471
DIP61A – 1-Form-A, high voltage ruthenium contact	471
DIP100 – 1-Form-A, Mini-DYAD™ current sensing	471

DIP 14 Series Reed Relays
 PRMA – Molded 8 pin, Form A, B and C dry reed 476
 DSS7 – Molded 4 pin dry reed 476
 PRME – Molded 8 pin, low profile dry reed 476

DIP 16 Series Reed Relays
 LSR – 2-Form-C, dry reed 483

MLR Series Reed Relays
 MLR31C – 1-Form-C, standard ruthenium contact 486
 MLR41A – 1-Form-A, DYAD® ruthenium contact 486
 MLR61A – 1-Form-A, high voltage ruthenium contact 486
 MLR100 – 1-Form-A, current sensing 486

MRBS Series Reed Relays
 MRBS – 1-Form-A 491
 MRBS2 – 1-Form-A, current sensing 491

MRF Series Reed Relays
 MRF4 – 1-Form-A, surface mount relay 494
 MRF8 – 1-Form-A, coaxial shield, high frequency, surface mount relay 494

SIP Series Reed Relays
 SIL4 – Instrument grade molded SIP relay 498
 DSS4 – General purpose molded SIP relay 498

SMR Series Reed Relays
 SMR4 – 1-Form-A, surface mount relay 504
 SMR6 – 1-Form-A, coaxial shielded, surface mount relay 504

TFT Series Reed Relays
 TFT31C – 1-Form-C, standard ruthenium contact 507
 TFT41A – 1-Form-A, DYAD® ruthenium contact 507
 TFT61A – 1-Form-A, high voltage 507
 TFT71A – 1-Form-A, high power, rhodium contact 507
 TFT91A – 1-Form-A, 1-Amp, 800V dielectric ruthenium contact 507

EMR Series Reed Relays
 LQ – 2-Form-C, 10 pin DIP 512
 LM – 2-Form-C, 16 pin DIP 512
 LX – 2-Form-C, 16 pin DIP 512

Section 6 – Switch and Sensor Products

Product Introduction 515
 MN1 – Mini-DYAD™ Form-A 516
 FR2 – DYAD® Form-A 516

Switch and Sensor Application Notes
 Reed Switches 523

Section 7 – Surge Protection Products

Gas Discharge Tube (GDT) Surge Arresters

Product Introduction	527
AC Series – Two electrode AC line protectors (120V)	528
CG/CG2 Series – Two electrode GDTs (75V – 1kV)	530
CG/CG2 SN Series – Two electrode, non-radioactive GDTs (90V – 470V)	533
CG3 Series – Two electrode, high voltage GDTs (1kV – 8.5kV)	536
CG5 Series – Two electrode, mini GDT (90-350V)	539
CG820 – Two electrode, gas filled, non-radioactive GDT (90V-350V)	541
PMT3(310) Series – Three electrode GDTs (150V-500V)	543
PMT8 Series – Three electrode, non-radioactive GDTs (90V – 350V)	546

High Energy Gas Discharge Tubes

Product Introduction	548
PMT/UMT(275) Series – High speed, high current surge protectors (350V – 2.5kV)	549
PMT(301) Series – High speed, high current surge protectors (350V – 3.5kV)	552
Sparkgaps – Two electrode high energy spark gaps (400V – 40kV)	555
Triggeregaps – High energy triggered spark gaps (1kV – 60kV)	558
UNI-IMPS – High speed transient surge protectors (550V – 20kV)	561
TG Legacy Series – High energy spark gap devices (345V – 60kV)	564
TD/TN Series – Microwave noise tubes and noise sources (0.2 – 220 GHz)	571

Surge Protection Products Application Notes

Why Use Surge Protection	576
A Comparison of Surge Protection Technologies	577
Basic Construction and Theory of Gas Discharge Tubes	581
Surge Protection of Main Distribution Frame	583
Surge Protection of AC Power Lines	588
Spark Gaps for Energy Transfer Applications	592
Use of Energy Transfer Switches	593
IEC-1000-4 Application Note	594
How to Test Spark Gaps	605
Use of Triggered Spark Gaps	607
Use of Microwave Noise Sources	609

Section 8 – Glossary 617

Section 9 – Index By Part Number 621

Partnerships in Quality

Worldwide, leading electronics engineers specify CP Clare products every working day for their critical applications. Partnerships in quality are the result, based on the CP Clare commitment to provide components that are consistently reliable, cost-effective and innovative.

Functioning at the critical interface between electrical power and sophisticated electronic devices are the following CP Clare product families: Circuits, Switches and Sensors, Reed Relays, Surge Protection devices and Advanced Magnetic Products. All of these products meet the most stringent requirements of manufacturers in the fields of data communications, wireless peripherals, telecommunications, automotive electronics, commercial aviation, industrial and process control, security, and test and measurement. Where quality components are needed to make a technological reality of a design engineer's dream, CP Clare products are specified.

Established in 1937, CP Clare has ISO 9001-certified production facilities in the U.S. and Mexico, plus a new state-of-the-art wafer fab in Beverly, Massachusetts. These facilities, together with CP Clare's research and development team, produce a constant stream of new components and applications that are directed at solving customer problems or building solutions to otherwise intractable electronics challenges. Quality, reliability, innovation and customization are the hallmarks of CP Clare products.

Circuits Products

The Circuits product family offers a broad range of relays, switches, optocouplers, integrated products and Data Access Arrangement (DAA) modules. Two types of relays are used: MOSFETs which can switch either AC or DC current signals in a small-size, highly reliable package; and AC relays that can switch much stronger output signals with better noise immunity. Optocouplers permit the transmission of a signal by optical rather than electrical means. This capability is critical, based on different operating voltages, for example. The small size of CP Clare's optocoupler makes it invaluable, in applications such as credit card-sized PCMCIA modems separating the telephone line system from the modem's more sensitive electronic components.

Switch and Sensor Products

CP Clare's DYAD® dry reed switches were the first commercially available switches to have surface mount capabilities. Inherently rugged, surface mounted switches

mean lower manufacturing and maintenance costs. In addition, they can be manufactured in high volumes and they function through millions of operations with low resistance. Dry reed switches are crucial components in cellular phones, automotive sensors, commercial and home security applications, and position and fluid level sensors.

Reed Relay Products

CP Clare introduced the first commercial reed relay in 1937. Since then our Reed Relay product family has expanded into a broad offering of relay solutions available in a variety of packaging options from single or dual in-line, through hole packages to several different surface mount configurations. CP Clare reed relays are key components for applications ranging from RF, telephone switching and cellular phones to automatic test equipment and commercial security.

Advanced Magnetic Products

CP Clare's Advanced Magnetic Products group includes DataLink® modem isolation transformers as well as custom and turnkey solutions, ranging from small coil windings to magnetic subassemblies including solenoids for use in lighting, power supply, automotive and computer industries. The DataLink® family of modem isolation transformers delivers high performance and superior economies achieved through superb design and process engineering for communications applications such as fax and modem.

Surge Protection Products

CP Clare offers a wide range of components that are used to provide continuous circuit protection from transient voltage spikes caused by lightning, inductive switching and electrostatic discharge. CP Clare's primary products are hermetically-sealed, gas-filled ceramic tubes (GDTs). Because of their high current handling capability, GDTs are used extensively to protect telecom equipment and operating personnel at both the central office and subscriber sites.

Quality Solutions for Customer Problems – On Time and On Budget





CP Clare is dedicated to helping its customers solve their toughest challenges. If no product from existing inventory meets customer requirements, CP Clare will collaborate with the customer in designing a new solution. And if the component is needed in record time, that challenge will also be met, so that CP Clare customers can best meet their own customer needs.









Product Name	MIT-101	New MIT-101V	MIT-115	New MIT-115V	MIT-125
Product Type	Wet Couplers	Wet Couplers	Wet Couplers	Wet Couplers	Dry Couplers
ITU Standard	V.32 bis @ 9.6kbps	V.32 bis @ 9.6kbps	V.32 bis @ 9.6kbps	V.32 bis @ 9.6kbps	V.32 bis @ 14.4kbps
Dimensions mm (LxWxH) (inches)	24.00 x 23.00 x 12.00 (0.945 x 0.906 x 0.472)	24.00 x 23.00 x 12.00 (0.945 x 0.906 x 0.472)	24.00 x 23.00 x 12.00 (0.945 x 0.906 x 0.472)	24.00 x 23.00 x 12.00 (0.945 x 0.906 x 0.472)	26.00 x 24.00 x 12.00 (1.024 x 0.945 x 0.472)
Total Harmonic Distortion (dB max.)	-	-	-	-	-76 (@ 600 Hz, -10 dBm)
Input/Output Isolation (V _{RMS})	1250 (min)	1250 (min)	1250 (min)	1250 (min)	1250 (min)
Insertion Loss (dB)	2.50 (@ 1kHz, 30 mADC)	2.50 (@ 1kHz, 30 mADC)	1.50 to 2.50 (@ 1kHz, 0 mADC) 2.75 (@1kHz, 100 mADC)	1.50 to 2.50 (@ 1kHz, 0 mADC) 2.75 (@1kHz, 100 mADC)	1.75 to 2.25 (@ 1kHz)
Return Loss (dB min.)	5.00 (200Hz - 500Hz) 8.00 (500Hz - 4000Hz)	5.00 (200Hz - 500Hz) 8.00 (500Hz - 4000Hz)	5.00 (200Hz - 1000Hz) 12.00 (1000Hz - 4000Hz)	5.00 (200Hz - 1000Hz) 12.00 (1000Hz - 4000Hz)	27 (200Hz - 1000Hz) 20 (1000Hz - 3000Hz)
Frequency Response (dB)	±4.00 (300Hz - 600Hz) ±1.00 (600Hz - 3500Hz)	±4.00 (300Hz - 600Hz) ±1.00 (600Hz - 3500Hz)	±2.50 (300Hz - 600Hz) ±0.65 (600Hz - 3500Hz)	±2.50 (300Hz - 600Hz) ±0.65 (600Hz - 3500Hz)	±0.25 (200Hz - 4000Hz)
Longitudinal Balance (dB min.)	60 (60Hz - 1000Hz) 40 (1000Hz - 4000Hz)	60 (60Hz - 1000Hz) 40 (1000Hz - 4000Hz)	60 (60Hz - 1000Hz) 40 (1000Hz - 4000Hz)	60 (60Hz - 1000Hz) 40 (1000Hz - 4000Hz)	60 (200Hz-1000Hz) 40 (1000Hz - 4000Hz)
Primary Impedance (Ω)	600	600	600	600	600
Secondary Load (Ω)	470	470	470	470	374
DC Resistance (Ω)	108 ±10% (Pri) 120 ±10% (Sec)	108 ±10% (Pri) 120 ±10% (Sec)	108 ±10% (Pri) 120 ±10% (Sec)	108 ±10% (Pri) 120 ±10% (Sec)	108 ±10% (Pri) 120 ±10% (Sec)
DC Current in Primary (mADC)	100	100	100	100	-
Turns Ratio (Turns)	1.00: 1.00 ±2%	1.00: 1.00 ±2%	1.00: 1.00 ±2%	1.00: 1.00 ±2%	1.00: 1.00 ±2%
Approvals	UL/C-UL: E171120	UL/C-UL: E171120	UL/C-UL: E171120	UL/C-UL: E171120	UL/C-UL: E171120
Page Numbers	32-33	34-35	36-37	38-39	40-41



Product Name	MIT-131	MIT-139	New MIT-179	New MIT-205	New MIT-262
					
Product Type	Dry Couplers	Dry Couplers	Dry Couplers	Wet Couplers	Dry Couplers
ITU Standard	V.34 bis @ 33.6kbps	V.34 bis @ 33.6kbps	V.34 bis @ 33.6kbps	V.34 bis @ 33.6kbps	V.90 bis @ 56kbps
Dimensions mm (LxWxH) (inches)	26.00 x 24.00 x 12.00 (1.024 x 0.945 x 0.472)	26.00 x 24.00 x 12.00 (1.024 x 0.945 x 0.472)	26.00 x 24.00 x 12.00 (1.024 x 0.945 x 0.472)	24.00 x 23.00 x 12.00 (0.945 x 0.906 x 0.472)	23.70 x 19.70 x 11.80 (0.933 x 0.775 x 0.465)
Total Harmonic Distortion (dB max.)	-82 (@ 600Hz, -10dBm)	-86 (@ 600Hz, -10dBm)	-86 (@ 600Hz, -10dBm)	-75 (@ 600Hz, -10dBm)	-82 (@ 600Hz, -10dBm)
Input/Output Isolation (V_{RMS})	1250 (min)	1250 (min)	1250 (min)	1250 (min)	1250 (min)
Insertion Loss (dB)	1.75 to 2.25 (@ 1kHz)	2.50 to 3.50 (@ 1kHz)	2.50 to 3.50 (@ 1kHz)	1.50 to 2.50 (@ 1kHz, 100mADC)	1.75 to 2.25 (@ 1kHz)
Return Loss (dB min.)	20 (300Hz - 3000Hz)	20 (300Hz - 3000Hz)	30 (1000Hz)	14.00 (1000Hz)	15.00 (300Hz - 3000Hz)
Frequency Response (dB)	± 0.25 (200Hz - 4000Hz)	± 0.25 (200 Hz - 4000 Hz)	± 0.25 (200Hz - 4000Hz)	-1.50 (min) (200Hz - 400Hz) -0.70 (min) (400Hz - 600Hz) -0.40 (min) (600Hz - 1000Hz) 0.25 (max) (1000Hz - 4000Hz)	± 0.20 (200 Hz - 4000 Hz)
Longitudinal Balance (dB min.)	60 (200Hz - 1000Hz) 40 (1000Hz - 4000Hz)	60 (200Hz - 1000Hz) 40 (1000Hz - 4000Hz)	60 (60Hz - 1000Hz) 40 (1000Hz - 4000Hz)	66 (60Hz - 1000Hz) 46 (1000Hz - 4000Hz)	60 (60Hz - 1000Hz) 40 (1000Hz - 4000Hz)
Primary Impedance (Ω)	600	600	600	600	600
Secondary Load (Ω)	374	301	301	470	374
DC Resistance (Ω)	108 $\pm 10\%$ (Pri) 120 $\pm 10\%$ (Sec)	150 $\pm 10\%$ (Pri) 150 $\pm 10\%$ (Sec)	150 $\pm 10\%$ (Pri) 150 $\pm 10\%$ (Sec)	108 $\pm 10\%$ (Pri) 120 $\pm 10\%$ (Sec)	108 $\pm 10\%$ (Pri) 120 $\pm 10\%$ (Sec)
DC Current in Primary (mADC)	-	-	0	100	0
Turns Ratio (Turns)	1.00: 1.00 $\pm 2\%$	1.00: 1.00 $\pm 2\%$	1.00: 1.00 $\pm 2\%$	1.00: 1.00 $\pm 2\%$	1.00: 1.00 $\pm 2\%$
Approvals	UL/C-UL: E171120	UL/C-UL: E171120	UL/C-UL: Pending	UL/C-UL: E171120	UL/C-UL: E171120
Page Numbers	42-43	44-45	46-47	48-49	50-51



Product Name	New MIT-372	New MIT-538	New MIT-600	New MIT-3262	SMIT-204
					
Product Type	Dry Couplers	Dry Couplers	Wet Couplers	Dry Couplers	Dry Couplers PCMCIA
ITU Standard	V.90 bis @ 56 kbps	V.32 bis @ 14.4 kbps	V.32 bis @ 9.6 kbps	V.90 bis @ 56 kbps	V.32 bis @ 14.4 kbps
Dimensions mm (LxWxH) (inches)	26.00 x 24.00 x 12.00 (1.024 x 0.945 x 0.472)	23.70 x 19.70 x 11.80 (0.933 x 0.775 x 0.465)	19.68 x 18.3 x 10.42 (0.775 x 0.720 x 0.410)	26.00 x 20.00 x 12.20 (1.024 x 0.787 x 0.480)	19.80 x 16.26 x 4.32 (0.780 x 0.640 x 0.170)
Total Harmonic Distortion (dB max.)	-82 (@ 600Hz, -10dBm)	-72 (@ 600Hz, -10dBm)	-	-80 (max) (@ 150Hz, -3dBm) -82 (max) (@ 600Hz, -10dBm)	-76 (@ 600Hz, -10dBm)
Input/Output Isolation (V _{RMS})	1250 (min)	1250 (min)	3750 (min)	1250 (min)	1250 (min)
Insertion Loss (dB)	1.00 (@1kHz)	0.85 (@1kHz)	2.5 (@ 2000Hz)	1.75 to 2.25 (@1kHz)	2.90 to 3.40 (@1kHz)
Return Loss (dB min.)	25.00 (200Hz - 4000Hz)	25.00 (300Hz - 3000Hz)	8.00 (1000Hz)	18.00 (600Hz - 3000Hz)	25 (300Hz - 4000Hz)
Frequency Response (dB)	±0.20 (200Hz - 4000Hz)	±0.20 (200Hz - 4000Hz)	±6.00 (300Hz - 600Hz) ±1.00 (600Hz - 4000Hz)	±0.20 (200Hz - 4000Hz)	±0.25 (200Hz - 4000Hz)
Longitudinal Balance (dB min.)	60 (60Hz-1000Hz) 40 (1000Hz-4000Hz)	60 (60Hz-1000Hz) 40 (1000Hz-4000Hz)	60 (60Hz-1000Hz) 40 (1000Hz-4000Hz)	60 (60Hz-1000Hz) 40 (1000Hz-4000Hz)	60 (200Hz-1000Hz) 40 (1000Hz-4000Hz)
Primary Impedance (Ω)	600	600	600	600	600
Secondary Load (Ω)	530	536	560	374	294
DC Resistance (Ω)	43 ±10% (Pri) 43 ±10% (Sec)	43 ±10% (Pri) 43 ±10% (Sec)	70 ±10% (Pri) 70 ±10% (Sec)	108 ±10% (Pri) 120 ±10% (Sec)	156 ±10% (Pri) 145 ±10% (Sec)
DC Current in Primary (mADC)	0	0	50	0	0
Tums Ratio (Turns)	1.00: 1.00 ±2%	1.00: 1.00 ±2%	1.00: 1.00 ±2%	1.00: 1.00 ±2%	1.00: 1.00 ±2%
Approvals	UL/C-UL File: Pending	UL/C-UL File: Pending	UL/C-UL File: E171120	UL/C-UL File: E171120	UL/C-UL File: E171120
Page Numbers	52-53	54-55	56-57	58-59	72-73





SELECTION GUIDE

Advanced Magnetic Products









Product Name	SMIT-304	New SMIT-314	New SMIT-2393	New SMIT-2412	New EMIT-101
					
Product Type	Dry Couplers PCMCIA	Dry Couplers	Dry Couplers	Dry Couplers	Wet Couplers
ITU Standard	V.34 bis @ 33.6kbps	V.34 bis @ 33.6kbps	V.34 bis @ 33.6kbps	V.34 bis @ 33.6kbps	V.32 bis @ 9.6kbps
Dimensions mm (LxWxH) inches)	19.80 x 16.26 x 4.32 (0.780 x 0.640 x 0.170)	19.80 x 16.26 x 4.32 (0.780 x 0.640 x 0.170)	19.80 x 16.52 x 4.32 (0.780 x 0.650 x 0.170)	19.80 x 8.25 x 4.31 (0.615 x 0.325 x 0.170)	25.20 x 24.00 x 14.00 (0.992 x 0.945 x 0.551)
Total Harmonic Distortion (dB max.)	-82 (@ 600Hz, -10dBm)	-80 (@ 600Hz, -10dBm)	-82 (@ 600Hz, -10dBm)	-80 (@ 600Hz, -10dBm)	-
Input/Output Isolation (V _{RMS})	1250 (min)	2000 (min)	2000 (min)	1250 (min)	4000 (min)
Insertion Loss (dB)	2.90 to 3.40 (@ 1kHz)	3.00 to 4.00 (@ 1kHz)	2.95 to 3.45 (@ 1kHz)	3.05 to 3.55 (@ 1kHz)	2.50 (@ 1kHz)
Return Loss (dB min.)	25 (300Hz - 4000Hz)	15.00 (300Hz - 3000Hz)	20.00 (300Hz - 3500Hz)	25 (300Hz - 3500Hz)	5.00 (200Hz - 500Hz) 8.00 (500Hz - 4000Hz)
Frequency Response (dB)	±0.25 (200Hz - 4000Hz)	±0.25 (200Hz - 4000Hz)	±0.25 (200Hz - 4000Hz)	±0.15 (300Hz - 3500Hz)	±4.00 (300Hz - 600Hz) ±1.00 (600Hz - 4000Hz)
Longitudinal Balance (dB min.)	60 (200Hz-1000Hz) 40 (1000Hz-4000Hz)	60 (60Hz-1000Hz) 40 (1000Hz-4000Hz)	60 (300Hz-1000Hz) 40 (1000Hz-4000Hz)	60 (200Hz-1000Hz) 40 (1000Hz-4000Hz)	66 (60Hz-1000Hz) 46 (1000Hz-4000Hz)
Primary Impedance (Ω)	600	600	600	600	600
Secondary Load (Ω)	294	294	294	301	470
DC Resistance (Ω)	156 ±10% (Pri) 145 ±10% (Sec)	270 ±10% (Pri) 295 ±10% (Sec)	145 ±10% (Pri) 160 ±10% (Sec)	140 ±10% (Pri) 160 ±10% (Sec)	108 ±10% (Pri) 120 ±10% (Sec)
DC Current in Primary (mADC)	0	0	0	0	100
Turns Ratio (Turns)	1.00: 1.00 ±2%	1.00: 1.00 ±2%	1.00: 1.00 ±2%	1.00: 1.00 ±2%	1.00: 1.00 ±2%
Approvals	UL/C-UL File: E171120	UL/C-UL File: Pending BSI Cert: 8122	UL/C-UL File: Pending	UL/C-UL File: Pending	UL/C-UL File: E171120
Page Numbers	74-75	76-77	78-79	80-81	60-61



Product Name	New EMIT-600	EMIT-1200	EMIT-2001	New EMIT-2020	New EMIT-3020
					
Product Type	Wet Couplers	Dry Couplers Encapsulated	Dry Couplers Encapsulated	Dry Couplers	Dry Couplers
ITU Standard	V.32 bis @ 9.6kbps	V.32 bis @ 14.4kbps	V.34 bis @ 33.6kbps	V.34 bis @ 33.6kbps	V.90 bis @ 56kbps
Dimensions mm (LxWxH) (inches)	21.50 x 18.30 x 13.80 (0.846 x 0.720 x 0.545)	18.30 x 18.30 x 13.80 (0.720 x 0.720 x 0.545)	18.30 x 18.30 x 13.80 (0.720 x 0.720 x 0.545)	18.30 x 18.30 x 13.80 (0.720 x 0.720 x 0.545)	18.30 x 18.30 x 13.80 (0.720 x 0.720 x 0.545)
Total Harmonic Distortion (dB max.)	-	-76 (@ 600Hz, -10dBm)	-82 (@ 600Hz, -10dBm)	-86 (@ 600Hz, -10dBm)	-75 (@ 150Hz, -3 dBm) -90 (@ 600Hz, -10dBm)
Input/Output Isolation (V_{RMS})	3750 (min)	3750 (min)	3750 (min)	3750 (min)	3750 (min)
Insertion Loss (dB)	2.50 (@ 2000Hz)	1.5 (@ 2kHz, $R_L=560 \Omega$)	1.5 (@ 2kHz, $R_L=560 \Omega$)	1.5 (@ 2kHz, $R_L=560 \Omega$)	2.0 (@ 2kHz, $R_L=560 \Omega$)
Return Loss (dB min.)	8.00 (@ 1kHz)	18 (200 Hz - 4000 Hz)	18 (200 Hz - 4000 Hz)	18-24 (200 Hz - 4000 Hz)	18 (1000 Hz - 4000 Hz)
Frequency Response (dB)	± 6.00 (300Hz - 600Hz) ± 1.00 (600Hz - 4000Hz)	± 0.2 (200Hz - 4000Hz)	± 0.2 (200Hz - 4000Hz)	± 0.2 (200Hz - 4000Hz)	± 0.4 (200Hz - 4000Hz)
Longitudinal Balance (dB min.)	60 (60Hz-1000Hz) 40 (1000Hz - 4000Hz)	60 (200Hz - 1000Hz) 40 (1000Hz - 4000Hz)	60 (200Hz - 1000Hz) 40 (1000Hz - 4000Hz)	60 (200Hz - 1000Hz) 40 (1000Hz - 4000Hz)	60 (200Hz - 1000Hz) 40 (1000Hz - 4000Hz)
Primary Impedance (Ω)	600	600 (& complex)	600 (& complex)	600	600
Secondary Load (Ω)	560	560	560	560	560
DC Resistance (Ω)	67 $\pm 10\%$ (Pri) 67 $\pm 10\%$ (Sec)	67 $\pm 10\%$ (Pri) 67 $\pm 10\%$ (Sec)	67 $\pm 10\%$ (Pri) 67 $\pm 10\%$ (Sec)	67 $\pm 10\%$ (Pri) 67 $\pm 10\%$ (Sec)	100 $\pm 10\%$ (Pri) 100 $\pm 10\%$ (Sec)
DC Current in Primary (mA DC)	50	-	-	0	0
Turns Ratio (Turns)	1.00: 1.00 $\pm 2\%$	1.00: 1.00 $\pm 2\%$	1.00: 1.00 $\pm 2\%$	1.00: 1.00 $\pm 2\%$	1.00: 1.00 $\pm 2\%$
Approvals	UL/C-UL File: E171120	UL/C-UL File: E171120 BSI for Austel 8047 for BS 415 / EN60950 BSI 8048 for BS 7002 / EN41003	UL/C-UL File: E171120 BSI for Austel 8047 for BS 415 / EN60950 BSI 8048 for BS 7002 / EN41003	UL/C-UL File: E171120 BSI Cert: 8047, 8048	UL/C-UL File: E171120 BSI Cert: 8047, 8048
Page Numbers	62-63	64-65	66-67	68-69	70-71



Product Name	New ESMIT-100	New ESMIT-300
		
Product Type	Dry Couplers	Dry Couplers
ITU Standard	V.32 bis @ 14.4kbps	V.34 bis @ 33.6kbps
Dimensions (LxWxH)	mm (inches) 12.40 x 9.60 x 7.00 (0.488 x 0.378 x 0.276)	mm (inches) 12.40 x 9.60 x 7.00 (0.488 x 0.378 x 0.276)
Total Harmonic Distortion (dB max.)	-76 (@ 600Hz, -10dBm)	-82 (@ 600Hz, -10dBm)
Input/Output Isolation (V_{RMS})	4600 (min)	4600 (min)
Insertion Loss (dB)	2.0 (@ 2000Hz)	2.5 (@ 2000Hz)
Return Loss (dB min.)	24.00 (200Hz - 4000Hz)	24.00 (200Hz - 4000Hz)
Frequency Response (dB)	± 0.25 (200Hz - 4000Hz)	± 0.20 (200Hz - 4000Hz)
Longitudinal Balance (dB min.)	80 (60Hz - 4000Hz)	80 (60Hz - 4000Hz)
Primary Impedance (Ω)	600	600
Secondary Load (Ω)	330	330
DC Resistance (Ω)	115 $\pm 15\%$ (Pri) 115 $\pm 15\%$ (Sec)	150 $\pm 15\%$ (Pri) 150 $\pm 15\%$ (Sec)
DC Current in Primary (mADC)	0	0
Turns Ratio (Turns)	1.00: 1.00 $\pm 2\%$	1.00: 1.00 $\pm 2\%$
Approvals	UL/C-UL File: Pending BSI Cert: 8264	UL/C-UL File: Pending BSI Cert: 8264
Page Numbers	82-83	84-85

Product Series	New LCA/XCA	LCB	OMA	PLA	New LAA/XAA																																													
																																																		
Product Type	Single Pole OptoMOS® Relay	Single Pole OptoMOS® Relay	Single Pole OptoMOS® Relay	Single Pole OptoMOS® Relay	Dual Pole OptoMOS® Relay																																													
Package Type	6 Pin	6 Pin	6 Pin	6 Pin	8 Pin																																													
Contact Form	1-Form-A	1-Form-B	1-Form-A	1-Form-A	2-Form-A																																													
Features	<ul style="list-style-type: none"> • AC/DC Switching • 3750 V_{RMS} I/O Isolation • Machine Insertable, Wave Solderable • Optically Isolated I/O • Low Drive Current 	<ul style="list-style-type: none"> • AC/DC Switching • 3750 V_{RMS} I/O Isolation • Machine Insertable, Wave Solderable • Optically Isolated I/O • Low Drive Current 	<ul style="list-style-type: none"> • AC/DC Switching • 3750 V_{RMS} I/O Isolation • Machine Insertable, Wave Solderable • Optically Isolated I/O • Low Drive Current • Fast Switching Speeds 	<ul style="list-style-type: none"> • AC/DC Switching • 3750 V_{RMS} I/O Isolation • Machine Insertable, Wave Solderable • Optically Isolated I/O • Low Drive Current 	<ul style="list-style-type: none"> • AC/DC Switching • 3750 V_{RMS} I/O Isolation • Machine Insertable, Wave Solderable • Optically Isolated I/O • Low Drive Current 																																													
Dimensions*	<table border="1"> <tr><td>a</td><td>b</td><td>c</td></tr> <tr><td>8.38 x 9.144 x 7.239</td><td></td><td></td></tr> <tr><td>(0.330 x 0.360 x 0.285)</td><td></td><td></td></tr> </table>	a	b	c	8.38 x 9.144 x 7.239			(0.330 x 0.360 x 0.285)			<table border="1"> <tr><td>a</td><td>b</td><td>c</td></tr> <tr><td>8.38 x 9.144 x 7.239</td><td></td><td></td></tr> <tr><td>(0.330 x 0.360 x 0.285)</td><td></td><td></td></tr> </table>	a	b	c	8.38 x 9.144 x 7.239			(0.330 x 0.360 x 0.285)			<table border="1"> <tr><td>a</td><td>b</td><td>c</td></tr> <tr><td>8.38 x 9.144 x 7.239</td><td></td><td></td></tr> <tr><td>(0.330 x 0.360 x 0.285)</td><td></td><td></td></tr> </table>	a	b	c	8.38 x 9.144 x 7.239			(0.330 x 0.360 x 0.285)			<table border="1"> <tr><td>a</td><td>b</td><td>c</td></tr> <tr><td>8.38 x 9.144 x 7.239</td><td></td><td></td></tr> <tr><td>(0.330 x 0.360 x 0.285)</td><td></td><td></td></tr> </table>	a	b	c	8.38 x 9.144 x 7.239			(0.330 x 0.360 x 0.285)			<table border="1"> <tr><td>a</td><td>b</td><td>c</td></tr> <tr><td>9.652 x 9.144 x 7.239</td><td></td><td></td></tr> <tr><td>(0.380 x 0.360 x 0.285)</td><td></td><td></td></tr> </table>	a	b	c	9.652 x 9.144 x 7.239			(0.380 x 0.360 x 0.285)		
a	b	c																																																
8.38 x 9.144 x 7.239																																																		
(0.330 x 0.360 x 0.285)																																																		
a	b	c																																																
8.38 x 9.144 x 7.239																																																		
(0.330 x 0.360 x 0.285)																																																		
a	b	c																																																
8.38 x 9.144 x 7.239																																																		
(0.330 x 0.360 x 0.285)																																																		
a	b	c																																																
8.38 x 9.144 x 7.239																																																		
(0.330 x 0.360 x 0.285)																																																		
a	b	c																																																
9.652 x 9.144 x 7.239																																																		
(0.380 x 0.360 x 0.285)																																																		
Load Voltage	60-350 V	250-350V	250V	250-400V	250-350V																																													
Load Current	100-1000mA	120-170mA	50mA	150-250mA	100-170mA																																													
Input Control Current	2-50mA	5-50mA	10-50mA	0.5-50mA	5-50mA																																													
On Resistance (@ rated load current)	0.5-50Ω	10-35Ω	4-100Ω	7-100Ω	10-50Ω																																													
Current Limiting Available	Yes	No	Yes	Yes	Yes																																													
Mounting Options	Through Hole, Surface Mount, Tape & Reel	Through Hole, Surface Mount, Tape & Reel	Through Hole, Surface Mount, Tape & Reel	Through Hole, Surface Mount, Tape & Reel	Through Hole, Surface Mount, Flatpack, Tape & Reel																																													
Approvals	CSA File: LR43639 BSI Cert: 7344, 7896	CSA File: LR43639 BSI Cert: 7344	CSA File: LR43639 BSI Cert: 7344	CSA File: LR43639 BSI Cert: 7344	CSA File: LR43639 BSI Cert: 7344, 7727 & 7896																																													
Page Numbers	92-133	134-149	150-153	154-167	169-200																																													





* Dimensions are approximate

Key: a–Length

b–Width

c–Height

Circuit Products







Product Series	New LBA/XBA	New LBB/XBB	LCC	OAA	PAA
					
Product Type	Dual Pole OptoMOS® Relay	Dual Pole OptoMOS® Relay	Dual Pole OptoMOS® Relay	Dual Pole OptoMOS® Relay	Dual Pole OptoMOS® Relay
Package Type	8 Pin	8 Pin	8 Pin	8 Pin	8 Pin
Contact Form	1-Form-B/1-Form-A	2-Form-B	1-Form-C	2-Form-A	2-Form-A
Features	<ul style="list-style-type: none"> • AC/DC Switching • 3750 V_{RMS} I/O Isolation • Machine Insertable, Wave Solderable • Optically Isolated I/O • Low Drive Current 	<ul style="list-style-type: none"> • AC/DC Switching • 3750 V_{RMS} I/O Isolation • Machine Insertable, Wave Solderable • Optically Isolated I/O • Low Drive Current 	<ul style="list-style-type: none"> • AC/DC Switching • 3750 V_{RMS} I/O Isolation • Machine Insertable, Wave Solderable • Optically Isolated I/O • Low Drive Current 	<ul style="list-style-type: none"> • AC/DC Switching • 3750 V_{RMS} I/O Isolation • Machine Insertable, Wave Solderable • Optically Isolated I/O • Low Drive Current • Fast Switching Speeds 	<ul style="list-style-type: none"> • AC/DC Switching • 3750 V_{RMS} I/O Isolation • Machine Insertable, Wave Solderable • Optically Isolated I/O • Low Drive Current
Dimensions*	a b c	a b c	a b c	a b c	a b c
mm	9.652 x 9.144 x 7.239	9.652 x 9.144 x 7.239	9.652 x 9.144 x 7.239	9.652 x 9.144 x 7.239	9.652 x 9.144 x 7.239
(LxWxH)	(0.380 x 0.360 x 0.285)	(0.380 x 0.360 x 0.285)	(0.380 x 0.360 x 0.285)	(0.380 x 0.360 x 0.285)	(0.380 x 0.360 x 0.285)
Load Voltage	250-350V	250-350V	250-350V	250V	250-400V
Load Current	100-170mA	100-170mA	120-170mA	50mA	150-250mA
Input Control Current	5-50mA	5-50mA	10-50mA	10-50mA	5-50mA
On Resistance (@ rated load current)	10-50Ω	10-50Ω	20-35Ω	4-100Ω	7-100Ω
Current Limiting Available	Yes (Form A Pole Only)	No	No	No	Yes
Mounting Options	Through Hole, Surface Mount, Flatpack, Tape & Reel	Through Hole, Surface Mount, Flatpack, Tape & Reel	Through Hole, Surface Mount, Flatpack, Tape & Reel	Through Hole, Surface Mount, Flatpack, Tape & Reel	Through Hole, Surface Mount, Flatpack, Tape & Reel
Approvals	UL File: E76270 CSA File: LR 43639 BSI Cert: 7344, 7727 & 7896	CSA File LR43639 BSI Cert: 7344, 7896	CSA File: LR 43639 BSI Cert: 7344 & 7896	UL File: E76270 CSA File: LR43639 BSI Cert: 7344 & 7896	UL File: E76270 CSA File: LR43639 BSI Cert: 7344 & 7727
Page Numbers	201-238	239-258	259-268	269-272	273-282

* Dimensions are approximate

Key: a—Length

b—Width

c—Height

Product Series	New TS/XS	ITC	New IAA/IAB/IBB	New IAD	PLCA
	 			 	
Product Type	Multifunction OptoMOS® Relay	SSR with Optocoupler & Bridge Darlington	Two SSR's with Optocoupler	SSR with Two Optocouplers	SSR with Surge Arrester
Package Type	8 Pin / 8 Pin Narrow	16 Pin SOIC	16 Pin SOIC	16 Pin SOIC/ 16 Pin SOIC Narrow	8 Pin
Contact Form	1-Form-A or 1-Form-B	1-Form-A	2-Form-A or 2-Form-B or 1A/1B	1-Form-A	1-Form-A
Features	<ul style="list-style-type: none"> • AC/DC Switching • Current Detector for Ring Signal or Loop Current Detect • 1500 V_{RMS} I/O Isolation (Narrow Package) • 3750 V_{RMS} I/O Isolation • Machine Insertable, Wave Solderable • Optically Isolated I/O • Multi-Functions in One Package • Low Drive Current 	<ul style="list-style-type: none"> • AC/DC Switching • Current Detector for Ring Signal or Loop Current Detect • Darlington Transistor for Electronic "Dry" Circuits • 3750 V_{RMS} I/O Isolation • Machine Insertable, Wave Solderable • Optically Isolated I/O • Multi-Functions in One Package • Low Profile SOIC Package 	<ul style="list-style-type: none"> • AC/DC Switching • Current Detector for Ring Signal or Loop Current Detect • 3750 V_{RMS} I/O Isolation • Machine Insertable, Wave Solderable • Optically Isolated I/O • Multi-Functions in One Package • Low Drive Current • Low Profile SOIC Package 	<ul style="list-style-type: none"> • AC/DC Switching • Current Detector for Ring Signal or Loop Current Detect • 1500 V_{RMS} I/O Isolation (Narrow Package) • 3750 V_{RMS} I/O Isolation • Machine Insertable, Wave Solderable • Optically Isolated I/O • Multi-Functions in One Package • Low Drive Current • Low Profile SOIC Package 	<ul style="list-style-type: none"> • AC/DC Switching • 3750 V_{RMS} I/O Isolation • Machine Insertable, Wave Solderable • Optically Isolated I/O • Multi-Functions in One Package • Low Drive Current • Meets FCC Part 68 • Repetitive Surges with No Degradation • Board Space and Cost Savings
Dimensions*	a b c mm (LxWxH) (inches)	a b c mm (LxWxH) (inches)	a b c mm (LxWxH) (inches)	a b c mm (LxWxH) (inches)	a b c mm (LxWxH) (inches)
	9.652 x 9.144 x 7.239 (0.380 x 0.360 x 0.285)	10.160 x 10.363 x 2.108 (0.400 x 0.408 x 0.083)	10.160 x 10.363 x 2.108 (0.400 x 0.408 x 0.083)	10.160 x 10.363 x 2.108 (0.400 x 0.408 x 0.083)	9.652 x 9.144 x 7.239 (0.380 x 0.360 x 0.285)
Narrow Pkg	mm (LxWxH) (inches)	-	-	10.058 x 6.198 x 2.184 (0.396 x 0.244 x 0.086)	-
	9.550 x 6.198 x 2.184 (0.376 x 0.244 x 0.086)				
Load Voltage	250-400V	350V	350V	350V	350V
Load Current	100-170mA	120mA	100-120mA	100-120mA	120mA
Input Control Current	2-100mA	5 - 50mA	5 - 50mA	5 - 50mA	2-50mA
On Resistance (@ rated load current)	7-50Ω	15Ω	35-50Ω	35-50Ω	35Ω
Current Limiting Available	Yes	Yes	Yes (FORM A Pole only)	Yes	Yes
Mounting Options	Through Hole, Surface Mount, Flatpack, Tape & Reel	Surface Mount Tape & Reel	Surface Mount Tape & Reel	Surface Mount Tape & Reel	Through Hole, Surface Mount, Tape & Reel
Approvals	CSA File: LR43639 BSI Cert: 7344, 7696	UL File: E76270 CSA File: LR43639 BSI Cert: 7969	UL File: E76270 CSA File: LR43639 BSI Cert: 7969	UL File: 76270 CSA File: LR43639 BSI Cert: 7969	BSI Cert: 8029
Page Numbers	284-315	317-324	325-344	325-344	345-348



* Dimensions are approximate

Key: a—Length

b—Width



c—Height

Circuit Products

Product Series	New LOC	LIA
		
Product Type	Linear Optocoupler	Linear Integrated Amplifier
Package Type	8 Pin or 16 Pin SOIC/16 Pin SOIC Narrow	16 Pin DIP or SOIC
Features	<ul style="list-style-type: none"> • Couples Analog and Digital Signals • Wide Bandwidth (200 kHz) • High Gain Stability • THD 87dB Typical • 0.01% Servo Linearity • 1500 V_{RMS} I/O Isolation (Narrow Pkg) • 3750 V_{RMS} I/O Isolation • Machine Insertable, Wave Solderable • Optically Isolated I/O • Low Drive Current 	<ul style="list-style-type: none"> • Couples Analog and Digital Signals • Wide Bandwidth (200 kHz) • High Gain Stability • THD 87dB Typical • 0.01% Servo Linearity Typical • Wide Power Supply Range (+/-18V) • 3750 V_{RMS} I/O Isolation • Machine Insertable, Wave Solderable • Optically Isolated I/O • Low Drive Current
Dimensions*	a b c	a b c
(LxWxH)	mm 9.652 x 9.144 x 7.239 (inches) (0.380 x 0.360 x 0.285)	mm 19.202 x 9.144 x 7.239 (inches) (0.756 x 0.360 x 0.285)
Narrow Pkg (LxWxH)	mm 10.058 x 6.198 x 2.184 (inches) (0.396 x 0.244 x 0.086)	- -
Dark Current (max)	25nA	25nA
Power Supply Range	N/A	±18V
K1, Servo Gain (typ)	.007	.008
K2, Forward Gain (typ)	.007	.008
K3, Transfer Gain (typ)	1.0	1.0
DK3, Transfer Gain Linearity (max)	1.0%	.005%
Frequency Response (Photovoltaic)	40KHz	40KHz
Input Control Current	2-20mA	2-20mA
Mounting Options	Through Hole, Surface Mount, Flatpack, Low Profile SOIC, Tape & Reel	Through Hole, Low Profile SOIC Tape & Reel
Approvals	UL File: E76270 CSA File: LR43639 BSI Cert: 7692, 7694 & 7969	UL File: E76270 CSA: LR43639 BSI Cert: 7969
Page Numbers	350-355	356-359

* Dimensions are approximate



Key: a—Length
b—Width
c—Height

Product Series	LDA	LDA	FDA																											
																														
Product Type	Single Optocoupler	Dual Optocoupler	MOSFET Drive																											
Package Type	6 Pin	8 Pin	6 Pin																											
Contact Form	N/A	N/A	N/A																											
Features	<ul style="list-style-type: none"> • 3750 V_{RMS} I/O Isolation • Machine Insertable, Wave Solderable • Optically Isolated I/O • Single or Darlington Transistor Output 	<ul style="list-style-type: none"> • 3750 V_{RMS} I/O Isolation • Machine Insertable, Wave Solderable • Optically Isolated I/O • Single or Darlington Transistor Output 	<ul style="list-style-type: none"> • 3750 V_{RMS} I/O Isolation • Optically Isolated I/O • Low Drive Current 																											
Dimensions* mm (LxWxH) (inches)	<table border="0"> <tr> <td>a</td> <td>b</td> <td>c</td> </tr> <tr> <td>8.38 x 9.144 x 7.239</td> <td></td> <td></td> </tr> <tr> <td>(0.330 x 0.360 x 0.285)</td> <td></td> <td></td> </tr> </table>	a	b	c	8.38 x 9.144 x 7.239			(0.330 x 0.360 x 0.285)			<table border="0"> <tr> <td>a</td> <td>b</td> <td>c</td> </tr> <tr> <td>9.652 x 9.144 x 7.239</td> <td></td> <td></td> </tr> <tr> <td>(0.380 x 0.360 x 0.285)</td> <td></td> <td></td> </tr> </table>	a	b	c	9.652 x 9.144 x 7.239			(0.380 x 0.360 x 0.285)			<table border="0"> <tr> <td>a</td> <td>b</td> <td>c</td> </tr> <tr> <td>9.652 x 9.144 x 7.239</td> <td></td> <td></td> </tr> <tr> <td>(0.380 x 0.360 x 0.285)</td> <td></td> <td></td> </tr> </table>	a	b	c	9.652 x 9.144 x 7.239			(0.380 x 0.360 x 0.285)		
a	b	c																												
8.38 x 9.144 x 7.239																														
(0.330 x 0.360 x 0.285)																														
a	b	c																												
9.652 x 9.144 x 7.239																														
(0.380 x 0.360 x 0.285)																														
a	b	c																												
9.652 x 9.144 x 7.239																														
(0.380 x 0.360 x 0.285)																														
Peak Block Voltage	N/A	N/A	N/A																											
Load Voltage	-	-	10V																											
Load Current	N/A	N/A	1μA																											
Input Control Voltage	-	-	N/A																											
Input Control Current	6-100mA	6-100mA	2-100mA																											
On Resistance (@ rated load current)	N/A	N/A	N/A																											
Current Limiting Available	No	No	No																											
Mounting Options	Through Hole, Surface Mount, Tape & Reel	Through Hole, Surface Mount, Tape & Reel	Through Hole, Surface Mount, Tape & Reel																											
Approvals	UL File: E76270 CSA File: LR43639 BSI Cert: 7344	CSA File: LR43639 UL File: E76270 BSI Cert: 7344	BSI Cert: 7344																											
Page Numbers	378-380	381-383	394-395																											

* Dimensions are approximate





Key: a—Length
b—Width
c—Height

Circuit Products

Product Series	PD	PS	PM																											
																														
Product Type	Power Dip	Power Sip	Power Mini																											
Package Type	16 Pin DIP	8 Pin SIP	6 Pin																											
Contact Form	1-Form-A	1-Form-A	1-Form-A																											
Features	<ul style="list-style-type: none"> • AC/DC Switching • Provides Interface Between Logic and Power Systems • 3750 V_{RMS} I/O Isolation • Optically Isolated I/O • Zero-cross Detection • High Surge Capability 	<ul style="list-style-type: none"> • AC/DC Switching • Provides Interface Between Logic and Power Systems • 3750 V_{RMS} I/O Isolation • Optically Isolated I/O • Zero-cross Detection • High Surge Capability 	<ul style="list-style-type: none"> • AC/DC Switching • Provides Interface Between Logic and Power Systems • 3750 V_{RMS} I/O Isolation • Optically Isolated I/O • Zero-cross Detection • High Surge Capability 																											
Dimensions* mm (LxWxH) (inches)	<table border="1"> <tr> <td>a</td> <td>b</td> <td>c</td> </tr> <tr> <td>19.202</td> <td>x 9.144</td> <td>x 7.239</td> </tr> <tr> <td>(0.75)</td> <td>x (0.360)</td> <td>x (0.285)</td> </tr> </table>	a	b	c	19.202	x 9.144	x 7.239	(0.75)	x (0.360)	x (0.285)	<table border="1"> <tr> <td>a</td> <td>b</td> <td>c</td> </tr> <tr> <td>19.202</td> <td>x 3.302</td> <td>x 6.350</td> </tr> <tr> <td>(0.75)</td> <td>x (0.130)</td> <td>x (0.250)</td> </tr> </table>	a	b	c	19.202	x 3.302	x 6.350	(0.75)	x (0.130)	x (0.250)	<table border="1"> <tr> <td>a</td> <td>b</td> <td>c</td> </tr> <tr> <td>8.38</td> <td>x 9.144</td> <td>x 7.239</td> </tr> <tr> <td>(0.330)</td> <td>x (0.360)</td> <td>x (0.285)</td> </tr> </table>	a	b	c	8.38	x 9.144	x 7.239	(0.330)	x (0.360)	x (0.285)
a	b	c																												
19.202	x 9.144	x 7.239																												
(0.75)	x (0.360)	x (0.285)																												
a	b	c																												
19.202	x 3.302	x 6.350																												
(0.75)	x (0.130)	x (0.250)																												
a	b	c																												
8.38	x 9.144	x 7.239																												
(0.330)	x (0.360)	x (0.285)																												
Peak Block Voltage	400-600V	400-600V	400-600V																											
Load Current	1000mA	1000mA	500mA																											
Input Control Current	5-50mA	5-50mA	5-50mA																											
On Resistance (@ rated load current)	N/A	N/A	N/A																											
Current Limiting Available	No	No	No																											
Mounting Options	Through Hole	Through Hole	Through Hole, Surface Mount, Tape & Reel																											
Approvals	UL File: E69938 CSA File: LR43639	UL File: E69938 CSA File: LR43639	UL File: E69938 CSA File: LR43639																											
Page Numbers	385-387	388-390	391-393																											

* Dimensions are approximate

Key: a—Length
b—Width
c—Height



Product Series	CYG20XX	CYG21XX	CYG22XX	CYG2911
				
Product Type	DAA Module	DAA Module	DAA Module	DAA Module
Package Type	Dip	Dip	Dip	Dip
Features	<ul style="list-style-type: none"> • 28.8 kbps • Caller ID Available • Loop Current Sense Available • Ring Detection • Low Power Hookswitch • Surge Protection • Low THD Transformer • Gyration Circuitry • UL Approved • FCC Compatible 	<ul style="list-style-type: none"> • 28.8 kbps • Ring Detector • Low Power Hookswitch • Surge Protection • Low THD Transformer • Gyration Circuitry • BSI Tested for BABT Approval • PTT Compatibility 	<ul style="list-style-type: none"> • 28.8 kbps • Ring Detector • Low Power Hookswitch • Surge Protection • Low THD Transformer • Gyration Circuitry • 2-4 wire hybrid ckt. • UL Approved 	<ul style="list-style-type: none"> • 28.8 kbps • Caller ID Available • Another Phone Off Hook Sensing • Ring Detection • Low Power Hookswitch • Surge Protection • Low THD Transformer • Gyration Circuitry • UL Approved • FCC Compatible
Dimensions*				
	a b c	a b c	a b c	a b c
mm	27.18 x 27.18 x 10.16	27.18 x 27.18 x 10.16	27.18 x 27.18 x 10.16	27.18 x 27.18 x 10.16
(LxWxH)	(1.070 x 1.070 x 0.400)	(1.070 x 1.070 x 0.400)	(1.070 x 1.070 x 0.400)	(1.070 x 1.070 x 0.400)
On-Hook Impedence	10MΩ	10MΩ	10MΩ	10MΩ
Hookswitch Resistance	15Ω	35Ω	15Ω	15Ω
Hookswitch Power Source	5V	5V	5V	5V (Typ)
DC Loop Current	20-120mA	20-120mA	20-120mA	20-120mA
Return Loss	18dB _{MIN}	14dB _{MIN}	39dB _{MIN}	18dB _{MIN}
Insertion Loss				
Transmit	7dB	7dB	7dB	7dB
Receive	7dB	7dB	+1dB	7dB
THD	0.01%	0.01%	0.01%	0.01%
Ring Voltage				
Detection Range	20-150V _{RMS}	20-150V _{RMS}	20-150V _{RMS}	20-150V _{RMS}
Surge Protection Voltage	300V	300V	300V	300V
Isolation Voltage	1000V _{RMS}	1500V _{RMS}	1000V _{RMS}	1000V _{RMS}
Approvals	UL/C-UL File: E174201	UL/C-UL File: 174201 BSI Cert: 8123	UL/C-UL File: E174201	UL/C-UL File: Pending
Page Numbers	361-365	366-369	370-373	374-376

* Dimensions are approximate

Key: a—Length
b—Width
c—Height

SELECTION GUIDE

Reed Relays





Product Series	1" X 0.1" GRID REED RELAYS	ATE SERIES					
							
Package Type	MRB	ATE1	ATE2	ATE3	ATE4	ATE6	ATE7
Description	Potted dry 1" grid reed relay	E/S Shield	Coaxial Shield	Miniature Form C	High Reliability	High Voltage	Low Coil Power
Contact Forms	1A to 6A 1B or 2B 1C to 4C 1A or 2A Latch	1A	1A	1C	1A	1A	1A
Contact Rating (max)	10W	10W	10W	3W	10W	10W	10W
Features	<ul style="list-style-type: none"> • Multi-configurations & switching capability • Diode & shield options • Magnetically shielded 	<ul style="list-style-type: none"> • Small size • Magnetically shielded • Fast switching speed • RF transmission up to 1GHz • Designed for direct PC board or socket mounting 					
Dimensions ¹ (L x W x H)	mm (inches) 28.96 x 9.27 x 9.14 (1.14 x 0.365 x 0.36)	20.58 x 5.34 x 6.10 (0.81 x 0.21 x 0.24)					
Switching Voltage (max)	200VDC	200VDC	200VDC	125VDC	200VDC	400VDC	200VDC
Switching Current (max)	0.50A	0.50A	0.50A	0.25A	0.50A	0.50A	0.50A
Applications	Data Acquisition Telecom Multi-pole switching	IC Testers High Frequency Communications High Frequency Scanners					
Approvals	UL File: E43775 CSA File: LR51773	-	-	-	-	-	-
Page Numbers	451-458	459-463					

¹ 1 Pole (MRB)

Product Series	CUP SERIES	DIP SERIES			
					
Package Type	CUPV (1)	DIP1	DIP3	DIP4	DIP6
Description	Staggered pin dry reed relay	Current Sense Models	Low Power Dry Reed	Low Power Dry Reed	High Voltage Dry Reed
Contact Forms	1A, 2A, 3A, 4A, 5A, 1B, 2B	1A	1C	1A	1A
Contact Rating (max)	10W	10W	3W	10W	10W
Features	<ul style="list-style-type: none"> • Multiple configurations • Low level or high power switching capabilities • Magnetic shield option available • High input/output isolation available (4kV) 	<ul style="list-style-type: none"> • Current sense coils • High coil resistance capability • High isolation input/output (4KV) 			
Dimensions ¹					
	mm	19.0 x 10.2 x 10.2			
(L x W x H)	(inches)	(0.75 x 0.4 x 0.4)			
Switching Voltage (max)	200VDC	100VDC	125VDC	200VDC	400VDC
Switching Current (max)	0.75A	0.50A	0.25A	0.50A	0.50A
Applications	Telecom Test Equipment Instrumentation Data Acquisition	Telecom Security General Purpose			
Approvals	UL File: E43775 BSI Cert: 7836, 6735	UL File: 43775 CSA File: LR51773 BSI Cert: 8111			
Page Numbers	464-470	471-475			

¹ 1 Pole (CUP V)

Reed Relays



Product Series	DIP-14 PIN SERIES			DIP-16 PIN REED RELAYS
				
Package Type	PRMA	DSS7	PRME	LSR
Description	Standard 14 pin DIP package	14 pin DIP with high input/output isolation	Low profile 14 pin DIP	High isolation line switching reed relay
Contact Forms	1A, 2A, 1B, 1C	1A	1A	2C
Contact Rating (max)	10W	10W	10W	3W
Features	<ul style="list-style-type: none"> • Molded construction • Automatic insertion capability • Diode & ES shield options available • UL & VDE approved select models 			<ul style="list-style-type: none"> • High reliability switching • High power switching capabilities • High isolation input/output ($4K_{VRMS}$) • Input power <200 mW • Hermetically sealed contacts • Low input power requirements
Dimensions mm (L x W x H) (inches)	19.6 x 6.9 x 7.3 (0.77 x 0.27 x 0.29)	19.6 x 6.9 x 7.3 (0.77 x 0.27 x 0.29)	19.6 x 6.4 x 5.3 (0.77 x 0.25 x 0.21)	20.2 x 9.8 x 10.8 (0.795 x 0.39 x 0.425)
Switching Voltage (max)	200VDC ¹	200VDC	200VDC	100VDC
Switching Current (max)	0.50A	0.50A	0.50A	0.2A
Applications	Test Equipment Instrumentation Data Acquisition General Purpose			Telecom (Line switching, Pulse dialing) General Purpose Matrix Switching
Approvals	UL File: E43775 CSA File: 81479	UL File: E43775 BSI Cert: 7425	-	BSI Cert: 8138
Page Numbers	476-482			483-485

¹ Rating for 1A.



Reed Relays

Product Series		MLR SERIES			
					
Package Type	MLR1000	MLR3	MLR4	MLR6	
Description	Line sensing reed relay	Low power reed relay	Low power reed relay	High voltage reed relay	
Contact Forms	1A	1C	1A	1A	
Contact Rating (max)	10W	3W	10W	10W	
Features	<ul style="list-style-type: none"> • High input/output isolation available (4kV) • High coil resistance capability 	<ul style="list-style-type: none"> • High input/output isolation available (4kV) • High coil resistance capability 			
Dimensions (L x W x H)	mm (inches)	22.5 x 10.5 x 10.25 (0.866 x 0.413 x 0.404)		22.0 x 10.16 x 10.10 (0.86 x 0.40 x 0.398)	
Switching Voltage (max)	100VDC	150VDC	200VDC	400VDC	
Switching Current (max)	0.50A	0.25A	0.50A	0.50A	
Applications	Telecom Security General Purpose				
Approvals	UL File: E43775 CSA File: LR51773 BSI Cert: 8152, 8153				
Page Numbers	486-490				

Reed Relays

Product Series	MRBS SERIES		MRF SERIES	
				
Package Type	MRBS	MRBS2	MRF4	MRF8
Description	Low input power reed relay	Current sense reed relay	Microminiature surface mountable reed relay	Microminiature high frequency staggered pin reed relay
Contact Forms	1A	1A	1A	1A
Contact Rating (max)	10W	5W	3W	3W
Features	<ul style="list-style-type: none"> • Low input power requirements for direct control by CMOS/TTL IC • High isolation • High sensitivity current sensing 		<ul style="list-style-type: none"> • Smallest surface mount reed relay • Switches high frequency signals up to 3 GHz 	
Dimensions (L x W x H)	mm (inches)	30.0 x 13.0 x 13.5 (1.181 x 0.512 x 0.532)		7.62 x 5.08 x 4.35 max (0.3 x 0.2 x 0.171)
Switching Voltage (max)	200VDC	75VDC	100VDC	100VDC
Switching Current (max)	0.5A	0.15A	0.25A	0.25A
Applications	Battery Power Applications Telecom		ATE RF Miniaturization	
Approvals	UL File: E43775 CSA File: LR51773 BSI Cert: 7400		-	
Page Numbers	491-493		494-497	

Reed Relays



Product Series	SIP PACKAGES		SMR SERIES	
				
Package Type	DSS4	SIL4	SMR4	SMR6
Description	General purpose standard SIP	Instrument grade SIP	Surface mountable 4 pin reed relay	Coaxially shielded surface mount
Contact Forms	1A, 1B	1A, 1B	1A	1A
Contact Rating (max)	10W	10W	10W	10W
Features	<ul style="list-style-type: none"> • High isolation input/output • Miniature design • Molded single in-line package • Automatic insertion capability 		<ul style="list-style-type: none"> • Low profile • Compatible with all high temp surface mount process technology 	
Dimensions (L x W x H)	mm (inches)	19.05 x 5.08 x 7.62 (0.75 x 0.2 x 0.3)	19.05 x 5.08 x 7.62 (0.75 x 0.2 x 0.3)	19.1 x 6.1 x 4.6 (0.75 x 0.24 x 0.18)
Switching Voltage (max)		200VDC	200VDC	200VDC
Switching Current (max)		0.50A	0.50A	0.50A
Applications	Test Equipment Telecom Matrix Switching Data Acquisition		General Purpose IC Testers	
Approvals	UL File: E43775 CSA File: LR81479	UL File: E43775 CSA File: LR81479	-	-
Page Numbers	498-503		504-506	

SELECTION GUIDE



Reed Relays

Product Series	TFT SERIES				
					
Package Type	TFT3	TFT4	TFT6	TFT7	TFT9
Description	Dry reed relay	Dry reed relay	High voltage reed relay	High power switching	High voltage standoff
Contact Forms	1C	1A	1A	1A	1A
Contact Rating (max)	3W	10W	10W	50W	40W
Features	• High isolation input/output (2.5kV)				
Dimensions mm (L x W x H) (inches)	28.96 x 9.3 x 9.2 (1.14 x 0.365 x 0.362)				
Switching Voltage (max)	150VDC	200VDC	500VDC	200VDC	250VDC
Switching Current (max)	0.25A	0.50A	0.50A	1.00A	1.00A
Applications	Security General Purpose				
Approvals	UL File: E43775 CSA File: LR51773				
Page Number	507-511				



Electromechanical Relays

Product Series		ELECTROMECHANICAL RELAYS		
				
Package Type		LQ	LM	LX
Description		10 pin low profile DIP	16 pin DIP	16 pin high power, low profile DIP
Contact Forms		2C	2C	2C
Contact Rating (max) DC/AC		30W/62.5VA	30W/60VA	60W/125VA
Features		<ul style="list-style-type: none"> • Low cost multipole solution • Small size • Automatic insertion capability • High power switching capability 	<ul style="list-style-type: none"> • Low cost multipole solution • Small size • Automatic insertion capability • High power switching capability 	<ul style="list-style-type: none"> • Low cost multipole solution • Small size • Automatic insertion capability • High power switching capability
Dimensions	mm	14.3 x 9.3 x 5.5	20.2 x 9.8 x 12.5	20.2 x 10.0 x 10.0
(L x W x H)	(inches)	(0.56 x 0.366 x 0.21)	(0.8 x 0.385 x 0.492)	(0.8 x 0.39 x 0.39)
Switching Voltage (max)		220VDC	150VDC	220VDC
Switching Current (max)		2.00A	2.00A	2.00A
Applications		Telecom Test Equipment Instrumentation General Purpose	Telecom Test Equipment Instrumentation General Purpose	Telecom Test Equipment Instrumentation General Purpose
Approvals		UL File: E43775	UL File: E43775 CSA File: LR79791, LR62152	UL File: E43775 CSA File: LR79791, LR62152
Page Numbers		512-514		

Reed Switches

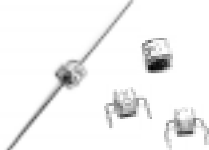

Product Series	REED SWITCHES	
		
Package Type	DYAD®	Mini-DYAD™
Description	Dry reed switch	Miniature dry reed switch
Contact Forms	1A	1A
Contact Rating (max)	10W	10W
Features	<ul style="list-style-type: none"> • Sputtered ruthenium contacts • Bifurcated contacts 	<ul style="list-style-type: none"> • Small size (only 10mm glass length) • 2.0 amp carry current • Strong rugged seal • Hermetically sealed contacts • Sputtered ruthenium contacts
Dimensions mm (inches) (Overall Length x Glass Length)	34.42 x 15.24 (1.355 x 0.6)	34.42 x 10.16 (1.355 x 0.4)
Switching Voltage (max)	200 VDC	200VDC
Switching Current (max)	0.50A	0.50A
Applications	Security sensors Automotive Telecom Industrial	Security sensors Automotive Telecom Industrial
Approvals	-	-
Page Numbers	516-522	

Surge Arresters



Product Series	Two Electrode AC Line Protectors	Two Electrode CG/CG2 Comgap: Std 75-470V			Two Electrode CG/CG2 SN Comgap: SN 90-470V	
						
Applications	AC Line Protection Long Branch Circuits Short Branch Circuits Submersible Pumps Power Strips	Telecom Equipment CATV Systems Test Equipment Computers Power Supplies Medical Equipment			Telecom Equipment CATV Systems Test Equipment Computers Power Supplies Medical Equipment	
Engineering Specifications	AC120	CG-V	CG2-V		CG-V-SN	CG2-V-SN
DC Breakdown@ 500V/s	225V min	75-110V	145V	230-470V	90V	230-470V
Impulse, max @ 100V/μs	700V	400-450V	500V	600-850V	400-450V	600-850V
Insulation Resistance, min	10 ¹⁰ Ω	10 ¹⁰ Ω	10 ¹⁰ Ω	10 ¹⁰ Ω	10 ¹⁰ Ω	10 ¹⁰ Ω
Capacitance, max @ 1MHz	1.0pF	1.0pF	1.0pF	1.0pF	1.0pF	1.0pF
Surge Life (Min)						
500A 10/1000μs pulses	-	1000 shots	1000 shots	1000 shots	400 shots	400 shots
.002μF thru 100Ω	-	-	-	-	-	-
.47μF thru 5.4μH	-	-	-	-	-	-
Max. Surge Current						
10kA 8/20μs pulses	4 shots	10 shots	10 shots	10 shots	10 shots	10 shots
20kA 8/20μs pulses	-	5 shots	5 shots	5 shots	-	-
10kA+10kA 8/20μs pulses	-	-	-	-	-	-
Max. AC Current						
10x for 1 sec @ 50/60 Hz	-	20A	20A	20A	20A	20A
11 cycles, 110VAC @ 50/60 Hz	-	-	-	-	-	-
Max. Follow-On Current						
1/2 cycle @ 50/60 Hz	>300Apk	-	-	20Apk	-	20Apk
Arc Voltage @ I=5A min	20V	10V	10V	15V	10V	10V
Part Numbers and Voltage Ranges	AC120L for 120VAC	CG75L = 60-90V CG90L = 72-108V CG110L = 88-132V CG2-145L = 116-174V CG2-230L = 184-276V CG2-250L = 200-300V CG2-300L = 240-360V CG2-350L = 280-420V CG2-470L = 376-564V			CG90LSN = 72-113V CG2-230LSN = 184-276V CG2-250LSN = 200-300V CG2-300LSN = 240-360V CG2-350LSN = 280-420V CG2-470LSN = 376-564V	
Dimensions, Non-Leaded diameter x length in mm	8.1 x 6.1	8.1 x 6.1			8.1 x 6.1	
Approvals	UL File: E111526 CSA File: LR89617 Meets IEEE C62.41-1991	UL File: E111526 Meets REA PE-80			UL File: E111526 Meets C0ITT-K12 Meets REA PE-80	
Page Numbers	528-529	530-532			533-535	

SELECTION GUIDE

Surge Arresters

Product Series	Two Electrode CG2 Comgap: 600-1000V	Two Electrode CG3 Comgap: 1.0-8.5kV		Two Electrode CG5 Comgap: 90-350V
				
Applications	Telecom Equipment Test Equipment CATV Systems Computers Power Supplies Medical Equipment	High Bias Voltage CRT Terminal CATV Systems Power Supplies Antennas Medical Equipment		Telecom Equipment CATV Systems Test Equipment Data Lines
Engineering Specifications	CG2-V	CG3-V		CG5-V
DC @ 500V/s	600-1000V	1.0-2.9kV	3.0-8.5kV	90-350V
Impulse, max @ 100V/μs	1000-1500V	1.5-4.5kV	4.5-13.5kV	400-700V
Insulation Resistance, min	10 ¹⁰ Ω	10 ¹⁰ Ω	10 ¹⁰ Ω	10 ¹⁰ Ω
Capacitance, max @ 1MHz	1.0pF	1.0pF	1.0pF	1.0pF
Surge Life (Min) 500A 10/1000μs pulses .002μF, 100 W .47μF, 5.4μH	1000 shots - -	- 500 shots -	- 500 shots -	(100A, 10/1000μs) 300 shots - -
Max. Surge Current 10kA 8/20μs pulses 20kA 8/20μs pulses 10kA+10kA 8/20μs pulses	10 shots - -	5 shots - -	5 shots - -	(5KA, 8/20μs) 5 shots - -
Max. AC Current 10x for 1 sec @ 50/60 Hz 11 cycles, 110VAC @ 50/60 Hz	10A -	- -	- -	5A -
Max. Follow-On Current 1/2 cycle @ 50/60 Hz	20Apk	>300Apk	>300Apk	-
Arc Voltage @ I=5A min	15V	10V	10V	25V
Part Numbers and Voltage Ranges	CG2-600L = 480-720V CG2-800L = 640-960V CG2-1000L = 800-1200V	CG3-1.0L = 850-1150V CG3-1.5L = 1275-1725V CG3-2.0L = 1700-2300V CG3-3.0L = 2550-3450V CG3-4.0L = 3400-4600V CG3-5.0L = 4250-5750V CG3-7.5L = 6375-8625V CG3-8.5L = 7225-9775V		CG5-90L = 72-108V CG5-230L = 184-276V CG5-350L = 280-420V
Dimensions, Non-Leaded diameter x length in mm	8.1 x 6.1	9.1 x 7.6	9.1 x 10.1	5.0 x 5.0
Approvals	UL File: E111526 Meets REAPE-80	UL File: E111526 UL File: E145934 CSA File: LR89617		-
Page Numbers	530-532	536-538		539-540

Surge Arresters

Product Series	Two Electrode CG820 Comgap: 90-350V	Three Electrode PMT3 Comgap: 75-500V		Three Electrode PMT8 Comgap: 90-350V
				
Applications	Telecom Lines CATV Equipment Test Equipment Data Lines Instrumentation Circuits Power Supplies	Telecom Protection Telephone Network Interfaces Telephone Line Cards Repeaters Modems Line Test Equipment	Telecom Protection Telephone Network Interfaces Telephone Line Cards Repeaters Modems Line Test Equipment	Telecom Protection Telecom Network Interfaces Telecom Line Cards Repeaters Line Test Equipment
Engineering Specifications (unless otherwise noted)	CG820-V-XX	PMT3(310)-V-XX		PMT8-V-XX
DC @ 500V/s	72-420V ¹	150V	230-600V	350V
Impulse, max @ 100V/μs	800-900V ²	500V	600-1000V	500-600V
Insulation Resistance, min	10 ¹⁰ Ω	10 ¹⁰ Ω	10 ¹⁰ Ω	10 ¹⁰ Ω
Capacitance, max @ 1MHz	1.5pF	1pF	1pF	1pF
Surge Life (Min) 500A 10/1000μs pulses .002μF thru 100 W .47μF thru 5.4μH	300 shots ³ - -	400 shots - -	400 shots - -	(100A, 10/1000μs) 300 shots
Max. Surge Current 10kA 8/20μs pulses 20kA 8/20μs pulses 10kA+10kA 8/20μs pulses	- 10 shots -	- - 10 shots	- - 10 shots	- - 10 shots
Max. AC Current 10x for 1 sec @ 50/60 Hz 11 cycles, 110VAC @ 50/60 Hz	20A -	- 65A + 65A	- 65A + 65A	- 65A + 65A
Max. Follow-On Current 1/2 cycle @ 50/60 Hz	-	-	20Apk	20Apk
Arc Voltage @ I=5A min	15V ⁴	-	-	16V
Part Numbers and Voltage Ranges	CG820-090 = 90V CG820-230 = 230V CG820-350 = 350V	PMT3(310)150XX = 120-180V PMT3(310)230XX = 184-276V PMT3(310)250XX = 200-300V PMT3(310)350XX = 280-420V PMT3(310)400XX = 300-500V PMT3(310)500XX = 400-600V		PMT8-90XX = 72-113V PMT8-230XX = 184-276V PMT8-350XX = 280-420V
Dimensions, Non-Leaded diameter x length in mm	7.60 x 20.00	8.25 x 12.0		8.25 x 12.2
Approvals	-	UL File: 145795 CSA File: LR89617 Meets REA PE-80		Mets CCITT-K12 Designed for Bellcore GR-1361-COR
Page Numbers	530-532	543-545		546-547

¹ At 100V/s

² At 1kV/ms



³ 100A (10/1000ms)

⁴ @ I = 0.5A min (-230, -350)



I = 1.0A min (-90)

SELECTION GUIDE

High Energy Devices

Product Series	Two Electrode Powergaps PMT(275)/UMT(275): 350-2500V		Two Electrode Powergaps PMT(301): 350-3500V
			
Applications	Ultra-Fast Surge Protection Test Equipment Video Displays Medical Electronics Instrumentation Circuits		Fast Surge Protection Test Equipment Medical Electronics Instrumentation Circuits TWT Drive Circuitry
Engineering Specifications	PMT(275)-V	UMT(275)-V	PMT(301)-V
DC @ 100V/s	350-500V	550-2500V	350-3500V
Impulse, max @ 5kV/μs	750V	750-3100V	-
Impulse, max @ 80kV/μs	-	-	1150-4470V
Insulation Resistance, min	10 ¹⁰ Ω	10 ¹⁰ Ω	10 ¹⁰ Ω
Capacitance, max @ 1MHz	4pF	4pF	4pF
Surge Life (Min)			6000-68100 shots
100A 8/20μs pulses	-	-	-
1kA 8/20μs pulses	500 shots	500 shots	-
3kA 8/20μs pulses	-	-	-
Discharge Life (Min)			
into 0.2Ω (≥1000x)	-	-	-
into 0.3Ω	-	-	-
into 1Ω (1000x)	-	-	-
Part Numbers and Voltage Ranges	PMT(275)350 = 315-385V PMT(275)400 = 360-440V PMT(275)450 = 405-495V PMT(275)500 = 450-550V UMT(275)550 = 495-605V UMT(275)600 = 540-660V UMT(275)650 = 585-715V UMT(275)750 = 675-825V UMT(275)800 = 720-880V UMT(275)850 = 765-935V UMT(275)1.0 = 0.90-1.10kV UMT(275)1.5 = 1.35-1.65kV UMT(275)2.0 = 1.80-2.20kV UMT(275)2.5 = 2.25-2.75kV		PMT(301)350 = 315-385V PMT(301)400 = 360-440V PMT(301)500 = 450-550V PMT(301)550 = 495-605V PMT(301)600 = 540-660V PMT(301)800 = 720-880V PMT(301)1.0 = 0.90-1.10kV PMT(301)1.5 = 1.35-1.65kV PMT(301)2.0 = 1.80-2.20kV PMT(301)2.5 = 2.25-2.75kV PMT(301)3.0 = 2.70-3.30kV PMT(301)3.5 = 3.15-3.85kV
Page Numbers	549-551		552-554

High Energy Devices

Product Series	Two Electrode Sparkgaps SB/SG: 400-40000V		Three Electrode Triggeregaps TA/TB/TG-221 1.0-60.0kV			Two Electrode UNI-IMPS UBD/UBT/UGT: 550-20000		
								
Applications	Overvoltage Protection & Energy Transfer Test Equipment Video Displays Pulse Generators		Overvoltage Protection & Energy Transfer Exploding Bridge Wire Systems Crowbars High Current Surge Generators Flashtube Triggers			Ultra-Fast Surge Protection Antenna Feedlines Test Equipment Video Displays Medical Electronics Instrumentation Circuits		
Engineering Specifications	SB-V	SG-V	TA-V	TB-V	TG-22X	UBD-V	UBT-V	UGT-V
DC @ 100V/s	400-5000V	2.0-40.0kV	1.0-15.0kV	2.5-25.0kV	1-60kV	0.55-4.0kV		4.0-20.0kV
Impulse, max @ 5kV/μs	-	-	-	-	-	0.66-4.8kV		4.8-24.0kV
Impulse, max @ 80kV/μs	-	-	-	-	-	-	-	-
Insulation Resistance, min	10 ¹⁰ Ω	10 ¹⁰ Ω	10 ¹⁰ Ω	10 ¹⁰ Ω	10 ¹⁰ Ω	10 ¹⁰ Ω	10 ¹⁰ Ω	10 ¹⁰ Ω
Capacitance, max @ 1MHz	-	-	-	-	-	2-5pF	2-5pF	2-5pF
Surge Life (Min)								
100A 8/20μs pulses	-	-	-	-	-	-	-	-
1kA 8/20μs pulses	-	-	-	-	-	-	-	-
3kA 8/20μs pulses	1100 shots	1500 shots	-	-	-	330-2400 shots	1300 shots	1300 shots
Discharge Life (Min)								
into 0.2Ω (≥1000x)	-	-	45-70J	-	-	-	-	-
into 0.3Ω	-	-	-	150-300J	-	-	-	-
into 1Ω (1000x)	-	-	-	-	3000-6000J	-	-	-
Part Numbers and Voltage Ranges	SB-400 = 360-440V SB-600 = 540-660V SB-800 = 720-880V SB-1.0 = 0.90-1.10kV SB-1.5 = 1.35-1.65kV SB-2.0 = 1.80-2.20kV SB-3.0 = 2.70-3.30kV SB-4.0 = 3.60-4.40kV SB-5.0 = 4.50-5.50kV SG-2.0 = 1.80-2.20kV SG-5.0 = 4.50-5.50kV SG-10.0 = 9.0-11.0kV SG-15.0 = 13.5-16.5kV SG-20.0 = 18.0-22.0kV SG-25.0 = 22.5-27.5kV SG-30.0 = 27.0-33.0kV SG-35.0 = 31.5-38.5kV SG-40.0 = 36.0-44.0kV		TA-1.0 = 0.90-1.10kV TA-2.0 = 1.80-2.20kV TA-5.0 = 4.50-5.50kV TA-7.0 = 6.30-7.70kV TA-10.0 = 9.0-11.0kV TA-15.0 = 13.5-16.5kV TB-2.5 = 2.25-2.75kV TB-5.0 = 4.50-5.50kV TB-10.0 = 9.0-11.0kV TB-15.0 = 13.5-16.5kV TB-20.0 = 18.0-22.0kV TB-25.0 = 22.5-27.5kV TG-221 = 1-20kV (user adjustable) TG-222 = 18-40kV (user adjustable) TG-224 = 1-20kV (user adjustable) TG-225 = 18-40kV (user adjustable) TG-226 = 35-60kV (user adjustable)			UBD-550 = 495-605V UBD-600 = 585-715V UBD-650 = 585-715V UBD-750 = 675-825V UBD-850 = 765-935V UBD-1.0 = 0.90-1.10kV UBD-1.2 = 1.08-1.32kV UBD-1.5 = 1.35-1.65kV UBD-2.0 = 1.80-2.20kV UBD-2.5 = 2.25-2.75kV UBD-3.0 = 2.70-3.30kV UBD-4.0 = 3.60-4.40kV UBT-4.0 or UGT-4.0 = 3.60-4.40kV UBT-5.0 or UGT-5.0 = 4.50-5.50kV UBT-6.0 or UGT-6.0 = 5.40-6.60kV UBT-7.5 or UGT-7.5 = 6.75-8.25kV UBT-10.0 or UGT-10.0 = 9.0-11.0kV UBT-12.0 or UGT-12.0 = 10.8-13.21kV UBT-15.0 or UGT-15.0 = 13.5-16.5kV UBT-20.0 or UGT-20.0 = 18.0-22.0kV		
Page Numbers	555-557		558-560			561-563		



Advanced Magnetic Products

Today's winning companies all over the world seek value-adding opportunities for all aspects of their businesses in order to compete effectively in globalized markets. Likewise, users of magnetic components look for industry leading suppliers to improve current levels of cost, quality and innovation.

CP Clare extends its leadership in quality, technology, and customer service through Advanced Magnetic Products. This Strategic Business Unit leverages long-standing CP Clare competencies in engineering and manufacturing of magnetic coils since 1937. Millions of advanced technology devices are sold annually, attesting to an international reputation for quality, innovation, and cost-effective design and manufacture of application-sensitive products.

CP Clare continually improves this performance to benefit a wide range of industries, including: Telcom, Datacom, Lighting, Automotive, Appliances, Utility Metering, Power Supply, Industrial Control, and Computers & Peripherals. Since the early '90s, the company delivers highly cost-effective custom, standard, and turnkey magnetics solutions via a dedicated Advanced Magnetic Products business unit.

Customer Partnership...DataLink® And Customer Value Response

The DataLink® standard product family of modem isolation transformers is primarily represented in their data book. The overarching goal behind DataLink® products has been superior economies in fax/modem solutions achieved via superb design and process engineering. Leveraging knowledge of fax/modem requirements demonstrated by CP Clare, future DataLink® products will increasingly challenge the frontiers of fax/modem performance both technically and economically for CP Clare customers.

The Advanced Magnetic Products portfolio includes many other products developed on a customer, out-sourcing basis for well-known customers. A broad range of magnetics engineering and manufacturing experiences continually expands future product options. For example, engineering successes progressed from Lighting industry balast applications to PC Display industry leadership "Cold Cathode Fluorescent Lighting" devices. Other successes have been as diverse as stators for electric motors all the way to turnkey power supplies for portable tools.

What underlies these successes has been global response to customer partnerships. The same emphasis on customer value will drive future analog fax/modem solutions in the DataLink™ family as well as expansion into other Telecom technologies and related industries.

Customer Satisfaction Excellence

Exceeding the expectations of world-class customers such as Motorola, AT&T, ABB, Diamond Multimedia, and Hayes has fueled high growth for Advanced Magnetic Products. Indeed, some of the world's most prestigious, quality-conscious customers have selected CP Clare as a single-source, ship-

to-stock resource. Customers report responses to their needs among the best they have experienced, and have cited design improvements, innovative manufacturing schemes, and surpassed quality goals.

Advanced Magnetic Products offers custom, standard, or complete turnkey solutions. Products meet optimum performance levels and quality at competitive price, backed up by service and support delivered by an industry leader.

Customer-Focused Professionals

The Advanced Magnetic Products professional team listens to customers, analyzes their needs, and then implements a realistic, flexible plan in order to exceed customer objectives in engineering, quality, delivery, cost, service, and support across every stage of product life cycles.

The Advanced Magnetic Products team assures manufacturability of very high-quality, low-cost magnetic components. Product development resides at the Arlington Heights (suburban Chicago) Technology Design Center. Manufacturing resides at Guadalajara, Mexico, a facility with 40,000 square feet of space and installed capacity of over 50 million units per year, and growing. On-site engineers contribute to product design and assure manufacturability.

State-of-the-Art Manufacturing

The Guadalajara facility produces a wide range of magnetic components for a wide range of applications, including:

- Small to medium-sized transformers and inductors using ferrite and lamination cores
- Electromechanical solenoids
- Electromagnetic field sensors
- Bobbin-wound coils in wire gauges from AWG 12 to AWG 46

State-of-the-art manufacturing processes include fully-automated robotic cells, using just-in-time techniques since 1985. Full time instructors operate a training facility. And all CP Clare locations are equipped with advanced information systems, satellite communications, and a highly developed network of preferred suppliers.

Recognized Superior Quality

At Advanced Magnetic Products, quality is built into every aspect of the organization. Statistical techniques are employed to monitor processes, quality equipment, measure performance, and correlate with customers. Reliability test facility and UL, C-UL and BSI follow-up services are provided. Custom-developed test facilities integrated into each manufacturing line assure quality and reliability.

In fact, CP Clare belongs to a select group of North American companies who have earned full ISO-9001 certification. This means that the spectrum of business activities – including design, manufacturing, and quality assurance – is independently audited and certified to fully conform to demanding global standards.

MODEM ISOLATION TRANSFORMERS

MIT-101



DESCRIPTION

The CP Clare MIT-101 Modem Isolation Transformer is a low-cost "Wet" modem coupler suitable for domestic V.32 9.6k fax, DBS/Set-top, CTI, POS, security and metering applications.

FEATURES

- Suitable for modem speeds up to V.32 (9.6k)
- Cost-effective "Wet" coupler construction reduces DAA components
- 1250 V_{RMS} dielectric input/output isolation (UL1459)
- Reflects 600Ω on Primary with 470Ω on Secondary
- Small PCB footprint (24mm x 23mm)
- Low profile (12mm)

APPROVALS

- UL/C-UL recognized file number: E171120

NOMENCLATURE

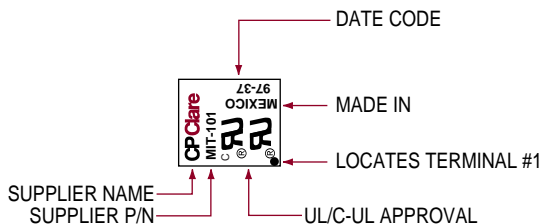

MECHANICAL DIMENSIONS

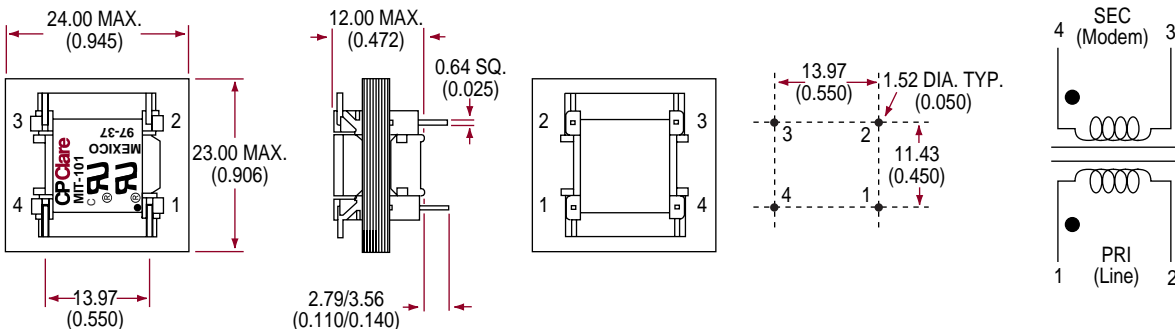

ELECTRICAL PERFORMANCE SPECIFICATIONS

Electrical Performance Specifications ($T_A = 25^\circ\text{C}$ unless otherwise specified)

PERFORMANCE PARAMETER	CONDITIONS	MIN	TYP	MAX	UNITS
Impedance	Reflected on PRI	-	600	-	Ω
	With Load on SEC	-	470	-	Ω
Insertion Loss	@ 1kHz with 30mADC	-	-	2.50	dB
Return Loss	200Hz - 500Hz	5.00	-	-	dB
	500Hz - 4000Hz	8.00	-	-	dB
Input/Output Isolation	-	1250	-	-	V_{RMS}
Frequency Response	300Hz - 600Hz	-	± 4.00	-	dB
	600Hz - 3500Hz	-	± 1.00	-	dB
Longitudinal Balance	60Hz - 1000Hz	60	-	-	dB
	1000Hz - 4000Hz	40	-	-	
DC Resistance @ $20^\circ\text{C} \pm 10\%$	Primary Winding	-	108	-	Ω
	Secondary Winding	-	120	-	Ω
DC Current in Primary	-	-	100	-	mADC
Turns Ratio	Pri to Sec, $\pm 2\%$	-	1.00:1.00	-	Turns
Operating Temperature	-	-40	-	+105	$^\circ\text{C}$
Storage Temperature	-	-40	-	+125	$^\circ\text{C}$
Soldering Temperature	10 Sec. Max.	-	-	+260	$^\circ\text{C}$

MODEM ISOLATION TRANSFORMERS

MIT-101V



DESCRIPTION

The CP Clare MIT-101V Modem Isolation Transformer is a low-cost "Wet" modem coupler suitable for domestic V.32 9.6k fax, DBS/Set-top, CTI, POS, security and metering applications. The MIT-101V survives 5kV transients.

FEATURES

- Suitable for modem speeds up to V.32 (9.6k)
- Cost-effective "Wet" coupler construction reduces DAA components
- 1250 V_{RMS} dielectric input/output isolation (UL1459)
- Enhances MIT-101 with 5000V transient survival
- Reflects 600Ω on Primary with 470Ω on Secondary
- Small PCB footprint (24mm x 23mm)
- Low profile (12mm)

APPROVALS

- UL/C-UL recognized file number: E171120

NOMENCLATURE

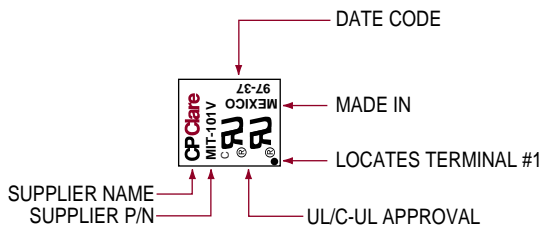

MECHANICAL DIMENSIONS

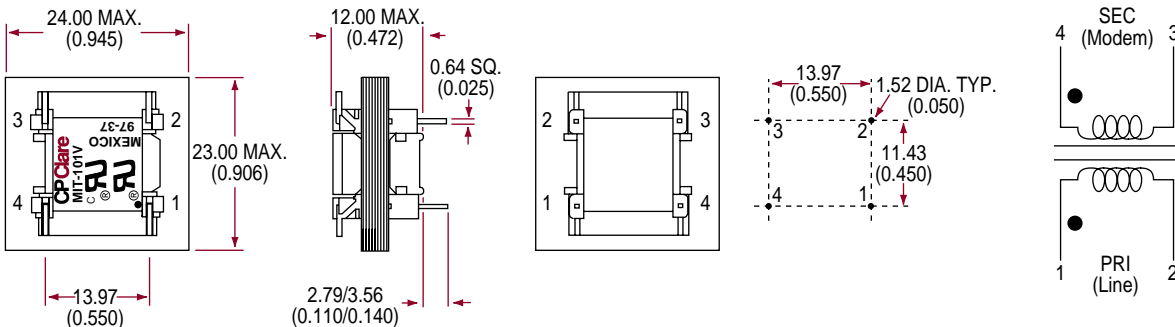

ELECTRICAL PERFORMANCE SPECIFICATIONS

Electrical Performance Specifications ($T_A = 25^\circ\text{C}$ unless otherwise specified)

PERFORMANCE PARAMETER	CONDITIONS	MIN	TYP	MAX	UNITS
Impedance	Reflected on PRI	-	600	-	Ω
	With Load on SEC	-	470	-	Ω
Insertion Loss	@ 1kHz with 30mADC	-	-	2.50	dB
Return Loss	200Hz - 500Hz	5.00	-	-	dB
	500Hz - 4000Hz	8.00	-	-	dB
Input/Output Isolation	-	1250	-	-	V_{RMS}
Frequency Response	300Hz - 600Hz	-	± 4.00	-	dB
	600Hz - 3500Hz	-	± 1.00	-	dB
Longitudinal Balance	60Hz - 1000Hz	60	-	-	dB
	1000Hz - 4000Hz	40	-	-	
DC Resistance @ $20^\circ\text{C} \pm 10\%$	Primary Winding	-	108	-	Ω
	Secondary Winding	-	120	-	Ω
DC Current in Primary	-	-	100	-	mADC
Turns Ratio	Pri to Sec, $\pm 2\%$	-	1.00:1.00	-	Turns
Operating Temperature	-	-40	-	+105	$^\circ\text{C}$
Storage Temperature	-	-40	-	+125	$^\circ\text{C}$
Soldering Temperature	10 Sec. Max.	-	-	+260	$^\circ\text{C}$

MODEM ISOLATION TRANSFORMERS

MIT-115



DESCRIPTION

The CP Clare MIT-115 Modem Isolation Transformer is a low-cost "Wet" modem coupler suitable for domestic V.32 9.6k fax, DBS/Set-top, CTI, POS, security and metering applications, featuring improved frequency response and return loss characteristics.

FEATURES

- Suitable for modem speeds up to V.32 (9.6k)
- Cost-effective "Wet" coupler construction reduces DAA components
- 1250 V_{RMS} dielectric input/output isolation (UL1459)
- Reflects 600Ω on Primary with 470Ω on Secondary
- Small PCB footprint (24mm x 23mm)
- Low profile (12mm)

APPROVALS

- UL/C-UL recognized file number: E171120

NOMENCLATURE

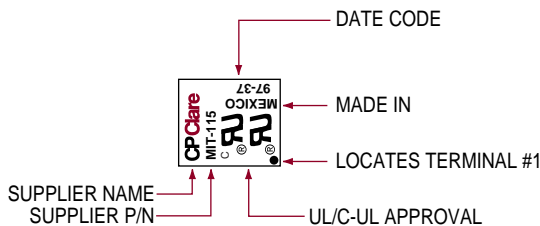

MECHANICAL DIMENSIONS

DIMENSIONS
mm
(inches)

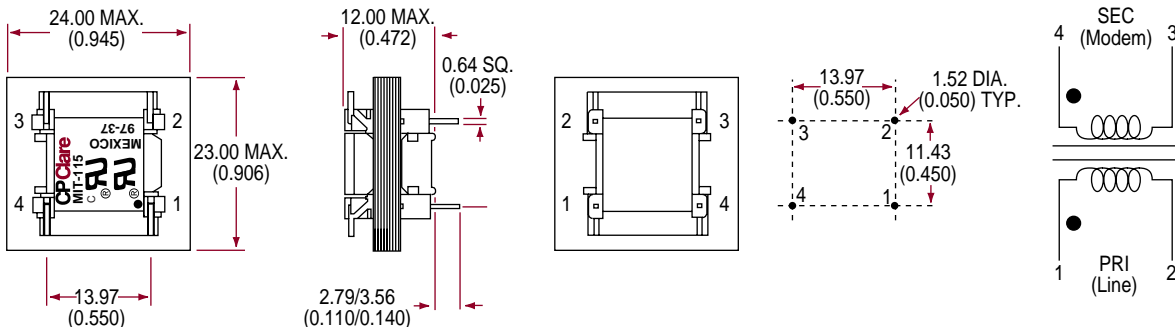

ELECTRICAL PERFORMANCE SPECIFICATIONS

Electrical Performance Specifications ($T_A = 25^\circ\text{C}$ unless otherwise specified)

PERFORMANCE PARAMETER	CONDITIONS	MIN	TYP	MAX	UNITS
Impedance	Reflected on PRI	-	600	-	Ω
	With Load on SEC	-	470	-	Ω
Insertion Loss	@ 1kHz, 0mADC	1.50	2.00	2.50	dB
	@ 1kHz, 100mADC	-	-	2.75	dB
Return Loss	200Hz - 1000Hz	5	-	-	dB
	1000Hz - 4000Hz	12	-	-	dB
Input/Output Isolation	-	1250	-	-	V_{RMS}
Frequency Response	300Hz - 600Hz	-	± 2.50	-	dB
	600Hz - 3500Hz	-	± 0.65	-	dB
Longitudinal Balance	60Hz - 1000Hz	60	-	-	dB
	1000Hz - 4000Hz	40	-	-	dB
DC Resistance @ $20^\circ\text{C}; \pm 10\%$	Primary Winding	-	108	-	Ω
	Secondary Winding	-	120	-	Ω
DC Current in Primary	-	-	100	-	mADC
Turns Ratio	Pri to Sec, $\pm 2\%$	-	1.00:1.00	-	Turns
Operating Temperature	-	-40	-	+105	$^\circ\text{C}$
Storage Temperature	-	-40	-	+125	$^\circ\text{C}$
Soldering Temperature	10 Sec. Max.	-	-	+260	$^\circ\text{C}$



DESCRIPTION

The CP Clare MIT-115V Modem Isolation Transformer is a low-cost "Wet" modem coupler suitable for domestic V.32 9.6k fax, DBS/Set-top, CTI, POS, security and metering applications, featuring improved frequency response and return loss characteristics. The MIT-115V survives 5kV transients.

FEATURES

- Suitable for modem speeds up to V.32 (9.6k)
- Cost-effective "Wet" coupler construction reduces DAA components
- 1250 V_{RMS} dielectric input/output isolation
- Enhances MIT-115 with 5000 V transient survival
- Reflects 600Ω on Primary with 470Ω on Secondary
- Small PCB footprint (24mm x 23mm)
- Low profile (12mm)

APPROVALS

- UL/C-UL recognized file number: E171120

NOMENCLATURE

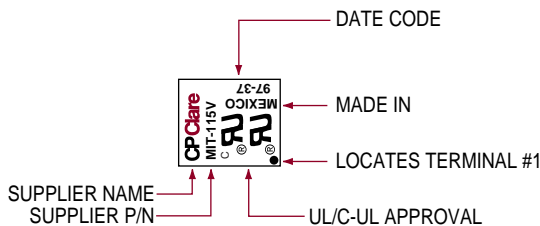

MECHANICAL DIMENSIONS

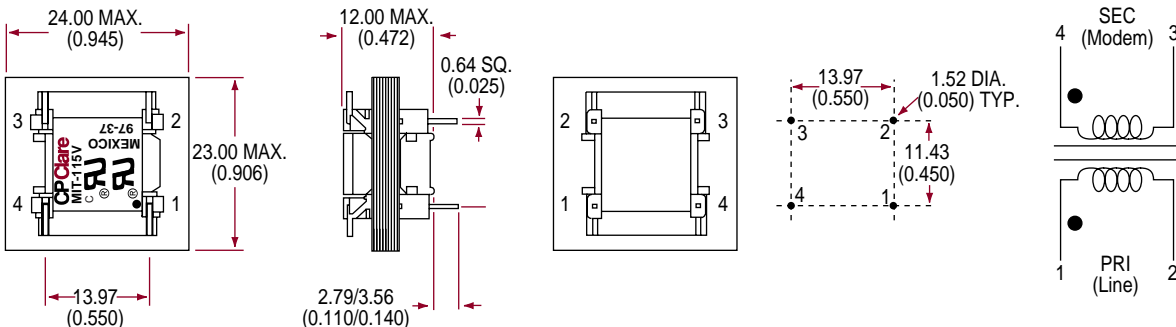

ELECTRICAL PERFORMANCE SPECIFICATIONS

Electrical Performance Specifications ($T_A = 25^\circ\text{C}$ unless otherwise specified)

PERFORMANCE PARAMETER	CONDITIONS	MIN	TYP	MAX	UNITS
Impedance	Reflected on PRI	-	600	-	Ω
	With Load on SEC	-	470	-	Ω
Insertion Loss	@ 1kHz, 0mADC	1.50	2.00	2.50	dB
	@ 1kHz, 100mADC	-	-	2.75	dB
Return Loss	200Hz - 1000Hz	5	-	-	dB
	1000Hz - 4000Hz	12	-	-	dB
Input/Output Isolation	-	1250	-	-	V_{RMS}
Frequency Response	300Hz - 600Hz	-	± 2.50	-	dB
	600Hz - 3500Hz	-	± 0.65	-	dB
Longitudinal Balance	60Hz - 1000Hz	60	-	-	dB
	1000Hz - 4000Hz	40	-	-	dB
DC Resistance @ $20^\circ\text{C}; \pm 10\%$	Primary Winding	-	108	-	Ω
	Secondary Winding	-	120	-	Ω
DC Current in Primary	-	-	100	-	mADC
Turns Ratio	Pri to Sec, $\pm 2\%$	-	1.00:1.00	-	Turns
Operating Temperature	-	-40	-	+105	$^\circ\text{C}$
Storage Temperature	-	-40	-	+125	$^\circ\text{C}$
Soldering Temperature	10 Sec. Max.	-	-	+260	$^\circ\text{C}$

MODEM ISOLATION TRANSFORMERS

MIT-125



DESCRIPTION

The CP Clare MIT-125 Modem Isolation Transformer is a low-cost "Dry" modem coupler suitable for domestic V.32bis 14.4k consumer, internet and CTI applications. Adaptable for V.34+ 33.6k and V.90 56k applications.

FEATURES

- Suitable for modem speeds up to V.32 bis (14.4k)
- Adaptable for modem speeds up to V.34+ (33.6k) and V.90 (56k)
- Total Harmonic Distortion rated -76dB max. @600Hz, -10dBm
- 1250 V_{RMS} dielectric input/output isolation (UL1459)
- Reflects 600Ω on Primary with 374Ω on Secondary
- Small PCB footprint (26mm x 24mm)
- Low profile (12mm)

APPROVALS

- UL/C-UL recognized file number: E171120

NOMENCLATURE

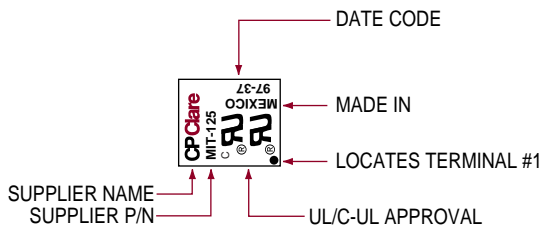

MECHANICAL DIMENSIONS

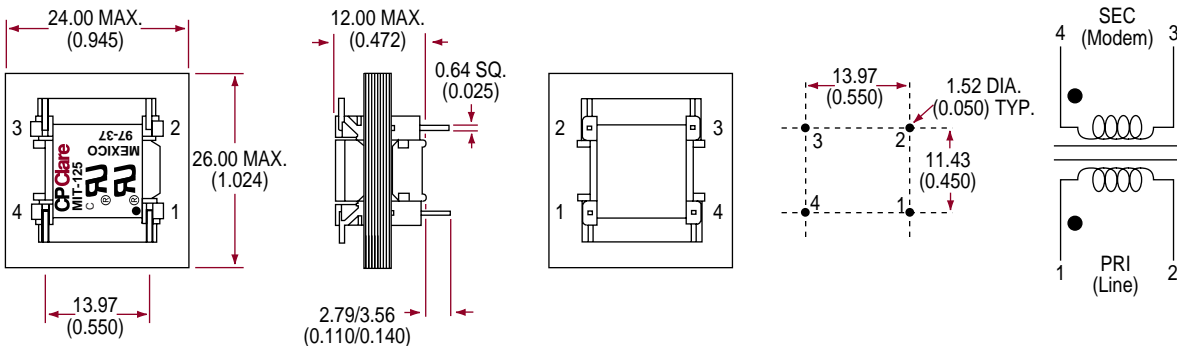

ELECTRICAL PERFORMANCE SPECIFICATIONS

Electrical Performance Specifications ($T_A = 25^\circ\text{C}$ unless otherwise specified)

PERFORMANCE PARAMETER	CONDITIONS	MIN	TYP	MAX	UNITS
Impedance	Reflected on PRI	-	600	-	Ω
	With Load on SEC	-	374	-	Ω
Total Harmonic Distortion	@ 600Hz, -10dBm	-	-	-76	dB
Insertion Loss	@ 1kHz	1.75	2.00	2.25	dB
Return Loss	200Hz - 1000Hz	27	-	-	dB
	1000Hz - 3000Hz	20	-	-	dB
Input/Output Isolation	-	1250	-	-	V_{RMS}
Frequency Response	200Hz - 4000Hz	-	± 0.25	-	dB
Longitudinal Balance	200Hz - 1000Hz	60	-	-	dB
	1000Hz - 4000Hz	40	-	-	dB
DC Resistance @ $20^\circ\text{C}; \pm 10\%$	Primary Winding	-	108	-	Ω
	Secondary Winding	-	120	-	Ω
DC Current in Primary	-	-	0	-	mADC
Turns Ratio	Pri to Sec, $\pm 2\%$	-	1.00:1.00	-	Turns
Operating Temperature	-	-40	-	+105	$^\circ\text{C}$
Storage Temperature	-	-40	-	+125	$^\circ\text{C}$
Soldering Temperature	10 Sec. Max	-	-	+260	$^\circ\text{C}$

MODEM ISOLATION TRANSFORMERS

MIT-131



DESCRIPTION

The CP Clare MIT-131 Modem Isolation Transformer is a low distortion "Dry" modem coupler suitable for high-performance domestic V.34+ 33.6k consumer and internet applications. Proven V.90 56k substitute for MIT-262.

FEATURES

- Suitable for modem speeds up to V.34+ (33.6k)
- Total Harmonic Distortion rated -82dB max. @600Hz, -10dBm
- 1250 V_{RMS} dielectric input/output isolation (UL1459)
- Reflects 600Ω on Primary with 374Ω on Secondary
- Small PCB footprint (26mm x 24mm)
- Low profile (12mm)

APPROVALS

- UL/C-UL recognized file number: E171120

NOMENCLATURE

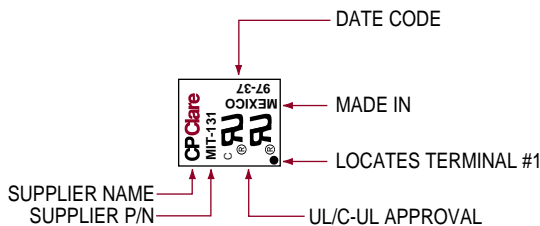

MECHANICAL DIMENSIONS

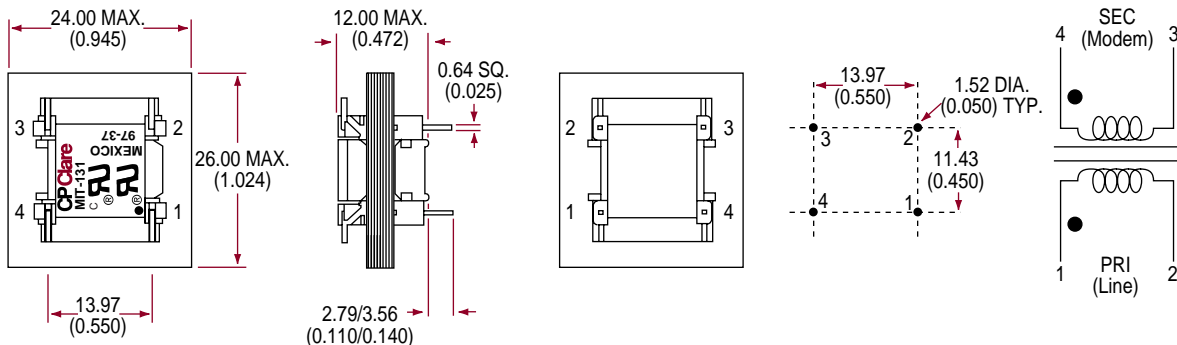

ELECTRICAL PERFORMANCE SPECIFICATIONS

Electrical Performance Specifications ($T_A = 25^\circ\text{C}$ unless otherwise specified)

PERFORMANCE PARAMETER	CONDITIONS	MIN	TYP	MAX	UNITS
Impedance	Reflected on PRI	-	600	-	Ω
	With Load on SEC	-	374	-	Ω
Total Harmonic Distortion	@ 600Hz, -10dBm	-	-	-82	dB
Insertion Loss	@ 1kHz	1.75	2.00	2.25	dB
Return Loss	300Hz - 3000Hz	20	-	-	dB
Input/Output Isolation	-	1250	-	-	V_{RMS}
Frequency Response	200Hz - 4000Hz	-	± 0.25	-	dB
Longitudinal Balance	200Hz - 1000Hz	60	-	-	dB
	1000Hz - 4000Hz	40	-	-	dB
DC Resistance @ $20^\circ\text{C}; \pm 10\%$	Primary Winding	-	108	-	Ω
	Secondary Winding	-	120	-	Ω
DC Current in Primary	-	-	0	-	mADC
Turns Ratio	Pri to Sec, $\pm 2\%$	-	1.00:1.00	-	Turns
Operating Temperature	-	-40	-	+105	$^\circ\text{C}$
Storage Temperature	-	-40	-	+125	$^\circ\text{C}$
Soldering Temperature	10 Sec. Max	-	-	+260	$^\circ\text{C}$

MODEM ISOLATION TRANSFORMERS

MIT-139



DESCRIPTION

The CP Clare MIT-139 Modem Isolation Transformer is a very low distortion “Dry” modem coupler suitable for very high performance domestic V.34+ 33.6k consumer and internet applications.

FEATURES

- Suitable for modem speeds up to V.34+ (33.6k)
- Total Harmonic Distortion rated -86dB max. @600Hz, -10dBm
- 1250 V_{RMS} dielectric input/output isolation (UL1459)
- Reflects 600Ω on Primary with 301Ω on Secondary
- Small PCB footprint (26mm x 24mm)
- Low profile (12mm)

APPROVALS

- UL/C-UL recognized file number: E171120

NOMENCLATURE

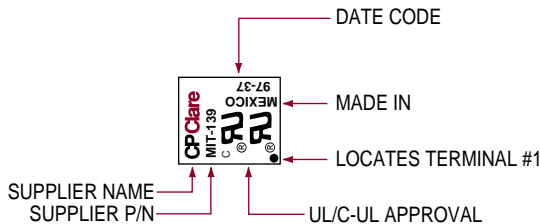

MECHANICAL DIMENSIONS

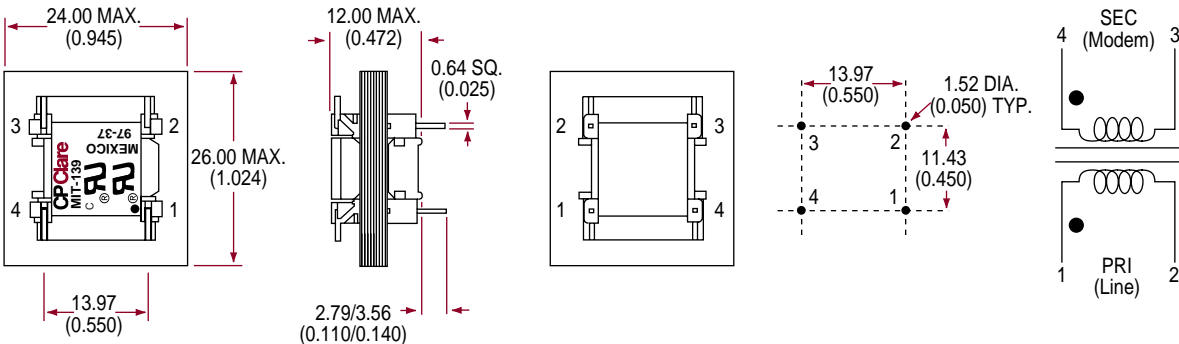

ELECTRICAL PERFORMANCE SPECIFICATIONS

Electrical Performance Specifications ($T_A = 25^\circ\text{C}$ unless otherwise specified)

PERFORMANCE PARAMETER	CONDITIONS	MIN	TYP	MAX	UNITS
Impedance	Reflected on PRI	-	600	-	Ω
	With Load on SEC	-	301	-	Ω
Total Harmonic Distortion	@ 600Hz, -10dBm	-	-	-86	dB
Insertion Loss	@ 1kHz	2.50	3.00	3.50	dB
Return Loss	300Hz - 3000Hz	20	-	-	dB
Input/Output Isolation	-	1250	-	-	V_{RMS}
Frequency Response	200Hz - 4000Hz	-	± 0.25	-	dB
Longitudinal Balance	200Hz - 1000Hz	60	-	-	dB
	1000Hz - 4000Hz	40	-	-	dB
DC Resistance @ $20^\circ\text{C}; \pm 10\%$	Primary Winding	-	150	-	Ω
	Secondary Winding	-	150	-	Ω
DC Current in Primary	-	-	0	-	mADC
Turns Ratio	Pri to Sec, $\pm 2\%$	-	1.00:1.00	-	Turns
Operating Temperature	-	-40	-	+105	$^\circ\text{C}$
Storage Temperature	-	-40	-	+125	$^\circ\text{C}$
Soldering Temperature	10 Sec. Max	-	-	+260	$^\circ\text{C}$

MODEM ISOLATION TRANSFORMERS

MIT-179



DESCRIPTION

The CP Clare MIT-179 Modem Isolation Transformer is a very low distortion “Dry” modem coupler suitable for high performance domestic V.34+ 33.6k consumer and internet applications.

FEATURES

- Suitable for modem speeds up to V.34+ (33.6k)
- Total Harmonic Distortion rated -86dB max. @ 600Hz, -10dBm
- 1250 V_{RMS} dielectric input/output isolation (UL1459)
- Reflects 600Ω on Primary with 301Ω on Secondary
- Small PCB footprint (26mm x 24mm)
- Low profile (12mm)

APPROVALS

- UL/C-UL recognized file number: Pending

NOMENCLATURE

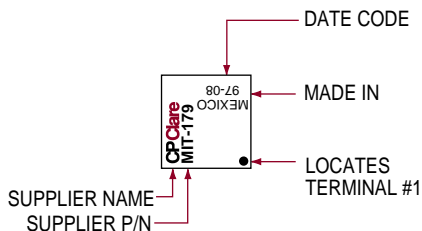

MECHANICAL DIMENSIONS

DIMENSIONS
mm
(inches)

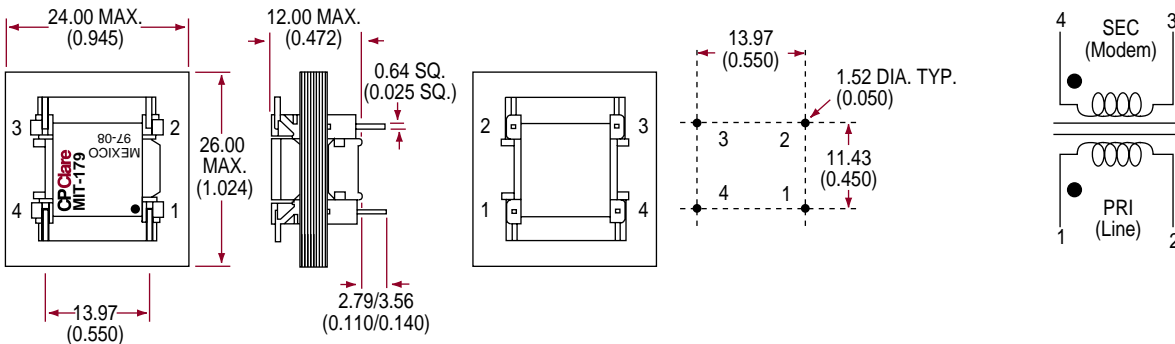

ELECTRICAL PERFORMANCE SPECIFICATIONS

Electrical Performance Specifications ($T_A = 25^\circ\text{C}$ unless otherwise specified)

PARAMETERS	CONDITIONS	MIN	TYP	MAX	UNITS
Impedance	Reflected on PRI	-	600	-	Ω
	With Load on SEC	-	301	-	Ω
Total Harmonic Distortion	@ 600Hz, -10dBm	-	-	-86	dB
Insertion Loss @ $20^\circ\text{C}; \pm 0.5\text{dB}$	Per IEEE method; @1000Hz	2.50	3.00	3.50	dB
Return Loss @ Room Temperature	1000Hz	-	30	-	dB
Input/Output Isolation	-	1250	-	-	V_{RMS}
Frequency Response	200Hz - 4000Hz	-	± 0.25	-	dB
Longitudinal Balance	Per FCC part 68.310 60Hz - 1000Hz	60	-	-	dB
	1000Hz - 4000Hz	40	-	-	dB
DC Resistance @ $20^\circ\text{C}; \pm 10\%$	Primary Winding	-	150	-	Ω
	Secondary Winding	-	150	-	Ω
DC Current in Primary	-	-	0	-	mADC
Turns Ratio	PRI to SEC; $\pm 2\%$	-	1.00:1.00	-	Turns
Operating Temperature	-	-40	-	+105	$^\circ\text{C}$
Storage Temperature	-	-40	-	+125	$^\circ\text{C}$
Soldering Temperature	10 Sec. Max.	-	-	+260	$^\circ\text{C}$

MODEM ISOLATION TRANSFORMERS

MIT-205



DESCRIPTION

The CP Clare MIT-205 Modem Isolation Transformer is a low distortion, low-cost “Wet” modem coupler adaptable for domestic V.34+ 33.6k consumer and internet applications.

FEATURES

- Adaptable for modem speeds up to V.34+ (33.6k)
- Total Harmonic Distortion rated -75dB typ. @ 600Hz, -10dBm
- Cost-effective “Wet” coupler construction reduces DAA components
- 1250 V_{RMS} dielectric input/output isolation (UL1459)
- Reflects 600Ω on Primary with 470Ω on Secondary
- Small PCB footprint (24mm x 23mm)
- Low profile (12mm)

APPROVALS

- UL/C-UL recognized file number: E171120

NOMENCLATURE

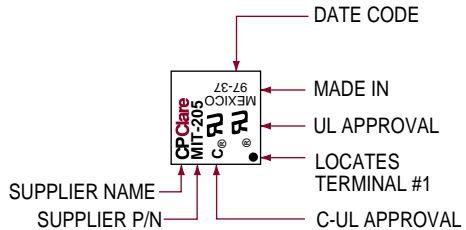

MECHANICAL DIMENSIONS

DIMENSIONS
mm
(inches)

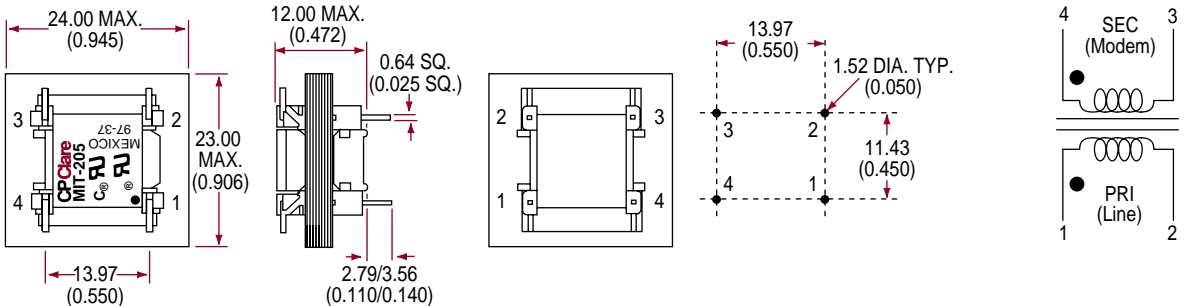

ELECTRICAL PERFORMANCE SPECIFICATIONS

Electrical Performance Specifications ($T_A = 25^\circ\text{C}$ unless otherwise specified)

PARAMETERS	CONDITIONS	MIN	TYP	MAX	UNITS
Impedance	Reflected on PRI	-	600	-	Ω
	With Load on SEC	-	470	-	Ω
Total Harmonic Distortion	@ 600Hz, -10dBm	-	-75	-	dB
Insertion Loss @ 20°C; $\pm 0.5\text{dB}$	@1kHz with 100 mADC	1.50	2.00	2.50	dB
Return Loss	1000Hz	-	14	-	dB
Input/Output Isolation	-	1250	-	-	V_{RMS}
Frequency Response	200Hz - 400Hz	-1.50	-	-	dB
	400Hz - 600Hz	-0.70	-	-	dB
	600Hz - 1000Hz	-0.40	-	-	dB
	1000Hz - 4000Hz	-	-	0.25	dB
Longitudinal Balance	60Hz - 1000Hz	66	-	-	dB
	1000Hz - 4000Hz	46	-	-	dB
DC Resistance @ 20°C; $\pm 10\%$	Primary Winding	-	108	-	Ω
	Secondary Winding	-	120	-	Ω
DC Current in Primary	-	-	100	-	mADC
Turns Ratio	PRI to SEC; $\pm 2\%$	-	1.00:1.00	-	Turns
Operating Temperature	-	-40	-	+105	$^\circ\text{C}$
Storage Temperature	-	-40	-	+125	$^\circ\text{C}$
Soldering Temperature	10 Sec. Max.	-	-	+260	$^\circ\text{C}$

MODEM ISOLATION TRANSFORMERS

MIT-262



DESCRIPTION

The CP Clare MIT-262 Modem Isolation Transformer is a low distortion "Dry" modem coupler suitable for high performance domestic V.90 56k consumer and internet applications.

FEATURES

- Suitable for modem speeds up to V.90 (56k)
- Total Harmonic Distortion rated -82dB max. @ 600Hz, -10dBm
- Insertion Loss rated 2.25dB max. @ 1000Hz
- 1250 V_{RMS} dielectric input/output isolation (UL1459)
- Reflects 600Ω on Primary with 374Ω on Secondary
- Small PCB footprint (28.3mm x 19.7mm)
- Low profile (11.8mm)

APPROVALS

- UL/C-UL recognized file number: E171120

NOMENCLATURE

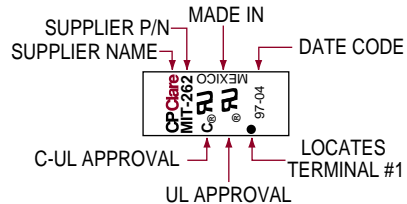

MECHANICAL DIMENSIONS

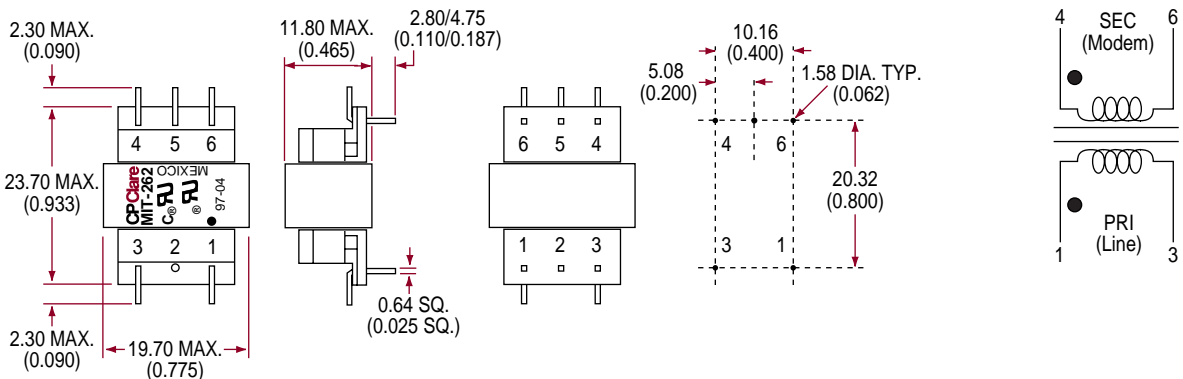

ELECTRICAL PERFORMANCE SPECIFICATIONS

Electrical Performance Specifications ($T_A = 25^\circ\text{C}$ unless otherwise specified)

PARAMETERS	CONDITIONS	MIN	TYP	MAX	UNITS
Impedance	Reflects on PRI	-	600	-	Ω
	With Load on SEC	-	374	-	Ω
Total Harmonic Distortion	@ 600Hz, -10dBm	-	-	-82	dB
Insertion Loss @ 20°C; $\pm 0.25\text{dB}$	Per IEEE method; @1000Hz	1.75	2.00	2.25	dB
Return Loss	300Hz - 3000Hz	15	-	-	dB
Input/Output Isolation	-	1250	-	-	V_{RMS}
Frequency Response	200Hz - 4000Hz	-	± 0.20	-	dB
Longitudinal Balance	Per FCC part 68.310				
	60Hz - 1000Hz	60	-	-	dB
	1000Hz - 4000Hz	40	-	-	dB
DC Resistance @ 20°C; $\pm 10\%$	Primary Winding	-	108	-	Ω
	Secondary Winding	-	120	-	Ω
DC Current in Primary	-	-	0	-	mADC
Turns Ratio	Pri to Sec, $\pm 2\%$	-	1.00:1.00	-	Turns
Inductance (Lp)	200Hz; $1V_{\text{RMS}}$	8	-	-	H
Operating Temperature	-	-40	-	+105	$^\circ\text{C}$
Storage Temperature	-	-40	-	+125	$^\circ\text{C}$
Soldering Temperature	10 Sec. Max.	-	-	+260	$^\circ\text{C}$

MODEM ISOLATION TRANSFORMERS

MIT-372



DESCRIPTION

The CP Clare MIT-372 Modem Isolation Transformer is a low distortion “Dry” modem coupler suitable for domestic V.90 56k consumer and internet applications featuring low insertion loss.

FEATURES

- Suitable for modem speeds up to V.90 (56k)
- Total Harmonic Distortion rated -82dB max. @ 600Hz, -10dBm
- Insertion Loss rated 1dB max. @ 1000Hz
- 1250 V_{RMS} dielectric input/output isolation (UL1459)
- Reflects 600Ω on Primary with 530Ω on Secondary
- Small PCB footprint (26mm x 24mm)
- Low profile (12mm)

APPROVALS

- UL/C-UL recognized file number: Pending

NOMENCLATURE

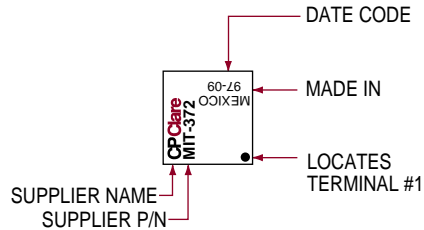

MECHANICAL DIMENSIONS

DIMENSIONS
mm
(inches)

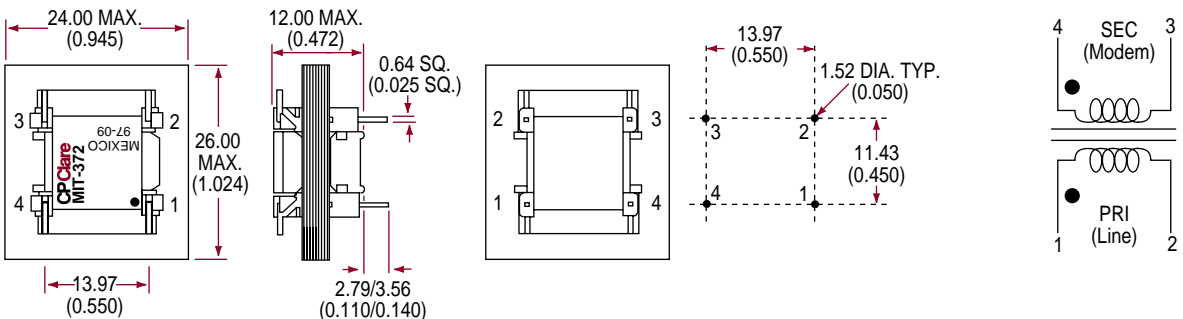

ELECTRICAL PERFORMANCE SPECIFICATIONS

Electrical Performance Specifications ($T_A = 25^\circ\text{C}$ unless otherwise specified)

PARAMETERS	CONDITIONS	MIN	TYP	MAX	UNITS
Impedance	Reflected on PRI	-	600	-	Ω
	With Load on SEC	-	530	-	Ω
Total Harmonic Distortion	@ 600Hz, -10dBm	-	-	-82	dB
Insertion Loss @ 20°C	Per IEEE method; @1000Hz	-	-	1.00	dB
Return Loss	200Hz - 4000Hz	25	-	-	dB
Input/Output Isolation	-	1250	-	-	V_{RMS}
Frequency Response	200Hz - 4000Hz	-	± 0.20	-	dB
Longitudinal Balance	Per FCC part 68.310				
	60Hz - 1000Hz	60	-	-	dB
	1000Hz - 4000Hz	40	-	-	dB
DC Resistance @ 20°C; $\pm 10\%$	Primary Winding	-	43	-	Ω
	Secondary Winding	-	43	-	Ω
DC Current in Primary	-	-	0	-	mADC
Turns Ratio	PRI to SEC; $\pm 2\%$	-	1.00:1.00	-	Turns
Inductance (Lp)	200Hz; $1V_{RMS}$	3	-	-	H
Operating Temperature	-	-40	-	+105	$^\circ\text{C}$
Storage Temperature	-	-40	-	+125	$^\circ\text{C}$
Soldering Temperature	10 Sec. Max.	-	-	+260	$^\circ\text{C}$

MODEM ISOLATION TRANSFORMERS

MIT-538



DESCRIPTION

The CP Clare MIT-538 Modem Isolation Transformer is a low insertion loss “Dry” modem coupler suitable for domestic V.32bis 14.4k consumer, internet, and CTI applications.

FEATURES

- Suitable for modem speeds up to V.32bis (14.4k)
- Total Harmonic Distortion rated -72dB max. @ 600Hz, -10dBm
- Insertion Loss rated 0.85dB max. @ 1000Hz
- 1250 V_{RMS} dielectric input/output isolation (UL1459)
- Reflects 600Ω on Primary with 536Ω on Secondary
- Small PCB footprint (28.3mm x 19.7mm)
- Low profile (11.8mm)

APPROVALS

- UL/C-UL recognized file number: Pending

NOMENCLATURE

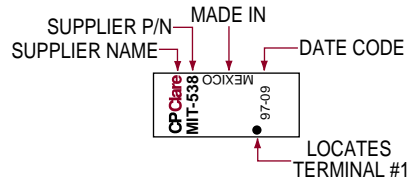

MECHANICAL DIMENSIONS

DIMENSIONS
mm
(inches)

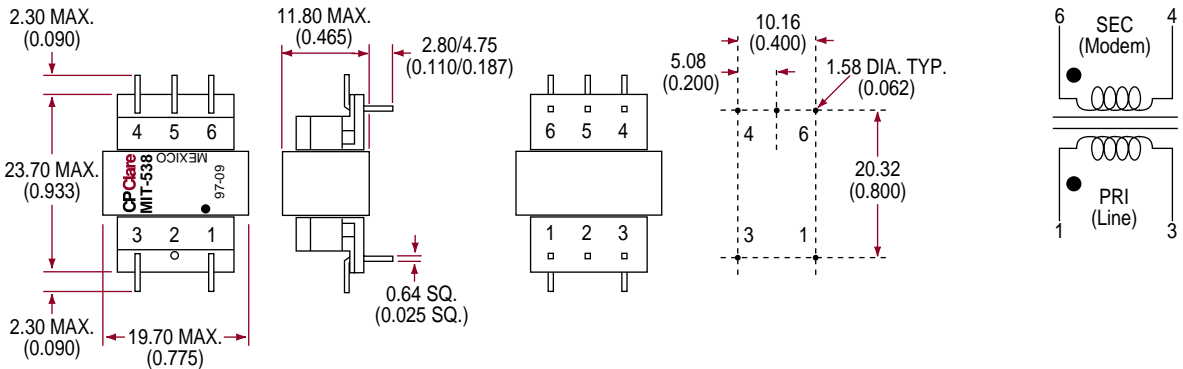

ELECTRICAL PERFORMANCE SPECIFICATIONS

Electrical Performance Specifications ($T_A = 25^\circ\text{C}$ unless otherwise specified)

PARAMETERS	CONDITIONS	MIN	TYP	MAX	UNITS
Impedance	Reflects on PRI	-	600	-	Ω
	With Load on SEC	-	536	-	Ω
Total Harmonic Distortion	@ 600Hz, -10dBm	-	-	-72	dB
Insertion Loss @ 20°C	Per IEEE method; @ 1000Hz	-	-	0.85	dB
Return Loss	300Hz - 3000Hz	25	-	-	dB
Input/Output Isolation	-	1250	-	-	V_{RMS}
Frequency Response	200Hz - 4000Hz	-	± 0.20	-	dB
Longitudinal Balance	Per FCC part 68.310				
	60Hz - 1000Hz	60	-	-	dB
	1000Hz - 4000Hz	40	-	-	dB
DC Resistance @ 20°C; $\pm 10\%$	Primary Winding	-	43	-	Ω
	Secondary Winding	-	43	-	Ω
DC Current in Primary	-	-	0	-	mADC
Turns Ratio	PRI to SEC, $\pm 2\%$	-	1.00:1.00	-	Turns
Operating Temperature	-	-40	-	+105	$^\circ\text{C}$
Storage Temperature	-	-40	-	+125	$^\circ\text{C}$
Soldering Temperature	10 Sec. Max.	-	-	+260	$^\circ\text{C}$

MODEM ISOLATION TRANSFORMERS

MIT-600



DESCRIPTION

The CP Clare MIT-600 Modem Isolation Transformer is a low-cost "Wet" modem coupler suitable for domestic V.32 9.6k fax, DBS/Set-top, CTI, POS security and metering applications in a small footprint and reduced profile.

FEATURES

- Suitable for modem speeds up to V.32 (9.6k) and voice
- Cost-effective "Wet" coupler construction reduces DAA components
- 3750 V_{RMS} dielectric input/output isolation (UL1459)
- Matches 600Ω and complex impedance telephone lines
- Uses a minimum of external components for impedance matching
- Small PCB footprint (18.3mm x 18.3mm)
- Low profile (10.42mm)

APPROVALS

- UL/C-UL recognized file number: E171120

NOMENCLATURE

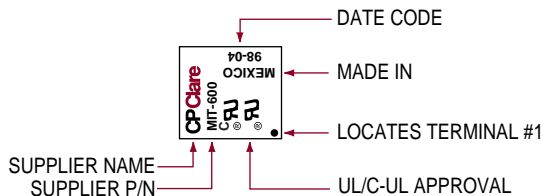

MECHANICAL DIMENSIONS

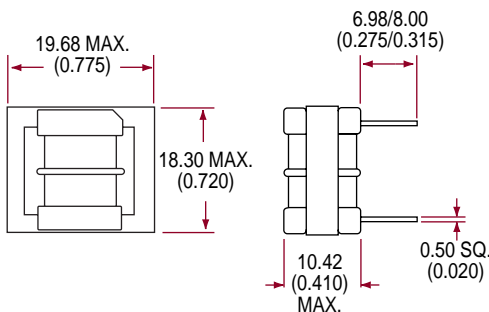

DIMENSIONS
mm
(inches)

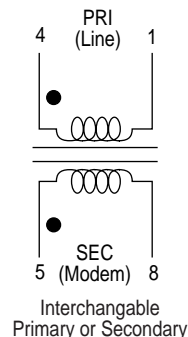
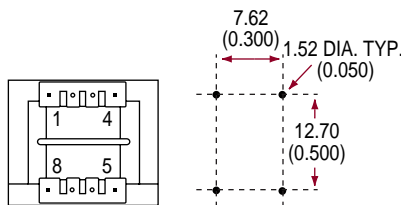

ELECTRICAL PERFORMANCE SPECIFICATIONS

Electrical Performance Specifications ($T_A = 25^\circ\text{C}$ unless otherwise specified)

PARAMETERS	CONDITIONS	MIN	TYP	MAX	UNITS
Impedance	Reflected on PRI	-	600	-	Ω
	With Load on SEC & Comp. circuit	-	560	-	Ω
Insertion Loss, @ 20°C	Per IEEE method; @ 2000Hz	-	-	2.5	dB
Return Loss	1000Hz	8	-	-	dB
Input/Output Isolation	-	3750	-	-	V_{RMS}
Frequency Response	300Hz - 600Hz	-	± 6.0	-	dB
	600Hz - 4000Hz	-	± 1.0	-	dB
Longitudinal Balance	Per FCC part 68.310	-	-	-	-
	60Hz - 1000Hz	60	-	-	dB
	1000Hz - 4000Hz	40	-	-	dB
DC Resistance, @ 20°C; $\pm 10\%$	Primary Winding	-	70	-	Ω
	Secondary Winding	-	70	-	Ω
DC Current in Primary	-	-	50	-	mADC
Turns Ratio	Pri to Sec; $\pm 2\%$	-	1.00:1.00	-	Turns
Operating Temperature	-	-40	-	+105	$^\circ\text{C}$
Storage Temperature	-	-40	-	+125	$^\circ\text{C}$
Soldering Temperature	10 Sec. Max	-	-	+260	$^\circ\text{C}$

MODEM ISOLATION TRANSFORMERS

MIT-3262



DESCRIPTION

The CP Clare MIT-3262 Modem Isolation Transformer is a very low distortion, high performance “Dry” modem coupler suitable for domestic V.90 56k consumer and internet applications. A great overall value!

FEATURES

- Suitable for modem speeds up to V.90 (56k)
- Total Harmonic Distortion rated:
-82dB max. -90dB typ. @ 600Hz, -10dBm;
-84dB typ. @ 150Hz, -3dBm
- Insertion loss rated 2.25dB max. @ 1000Hz
- 1250 V_{RMS} dielectric input/output isolation (UL1459)
- Reflects 600Ω on Primary with 374Ω on Secondary
- Small PCB footprint (26mm x 20mm)
- Low profile (12.2mm)
- Industry-standard pin configuration.

APPROVALS

- UL/C-UL recognized file number: E171120

NOMENCLATURE

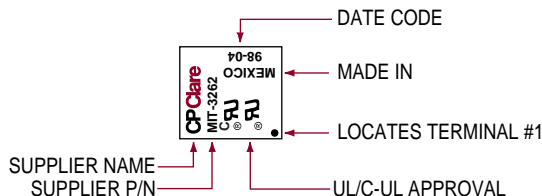

MECHANICAL DIMENSIONS

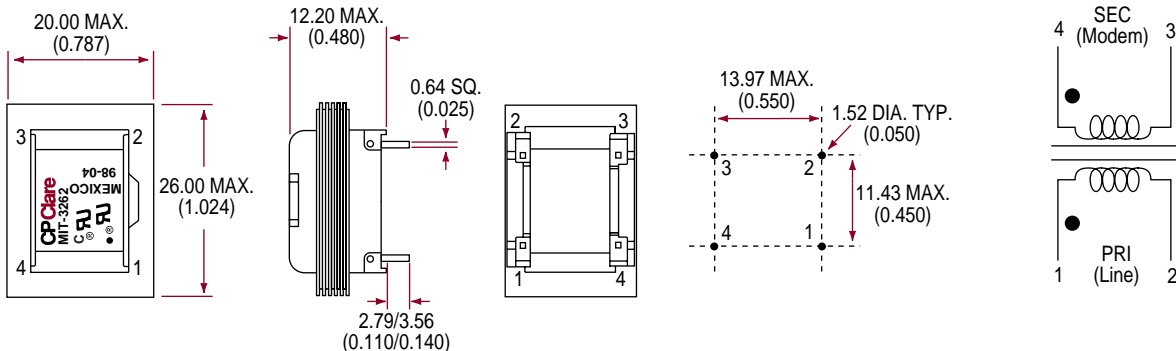

ELECTRICAL PERFORMANCE SPECIFICATIONS

Electrical Performance Specifications ($T_A = 25^\circ\text{C}$ unless otherwise specified)

PARAMETERS	CONDITIONS	MIN	TYP	MAX	UNITS
Impedance	Reflected on PRI	-	600	-	Ω
	With Load on SEC	-	374	-	Ω
Total Harmonic Distortion	@ 150Hz, -3dBm	-	-84	-80	dB
	@ 600Hz, -10dBm	-	-90	-82	dB
Insertion Loss, @ 20°C	Per IEEE method; @ 1000Hz	1.75	2.0	2.25	dB
Return Loss	600Hz - 3000Hz	18	-	-	dB
Input/Output Isolation	-	1250	-	-	V_{RMS}
Frequency Response	200Hz - 4000Hz	-	± 0.20	-	dB
Longitudinal Balance	Per FCC part 68.310				
	60Hz - 1000Hz	60	-	-	dB
	1000Hz - 4000Hz	40	-	-	dB
DC Resistance, @ 20°C; $\pm 10\%$	Primary Winding	-	108	-	Ω
	Secondary Winding	-	120	-	Ω
DC Current in Primary	-	-	0	-	mADC
Turns Ratio	Pri to Sec; $\pm 2\%$	-	1.00:1.00	-	Turns
Operating Temperature	-	-40	-	+105	$^\circ\text{C}$
Storage Temperature	-	-40	-	+125	$^\circ\text{C}$
Soldering Temperature	10 Sec. Max	-	-	+260	$^\circ\text{C}$

ENCAPSULATED MODEM ISOLATION TRANSFORMERS

EMIT-101



DESCRIPTION

The CP Clare EMIT-101 Encapsulated Modem Isolation Transformer is a low-cost "Wet" modem coupler suitable for V.32 9.6k fax, DBS/Set-top, CTI, POS, security, and metering applications. The EMIT-101 provides 4KV dielectric isolation for domestic systems.

FEATURES

- Suitable for modem speeds up to V.32 (9.6k)
- Cost-effective "Wet" coupler construction reduces DAA components
- 4000 V_{RMS} dielectric input/output isolation (UL1459)
- Reflects 600Ω on Primary with 470Ω on Secondary
- Small PCB footprint (25.2mm x 24.0mm)

APPROVALS

- UL/C-UL recognized file number: E171120

NOMENCLATURE

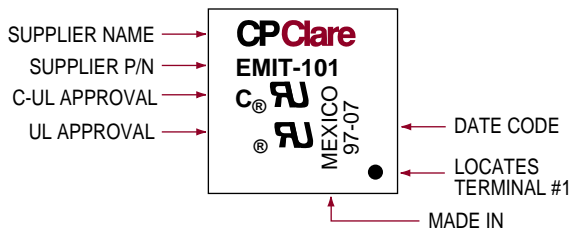

MECHANICAL DIMENSIONS

DIMENSIONS
mm
(inches)

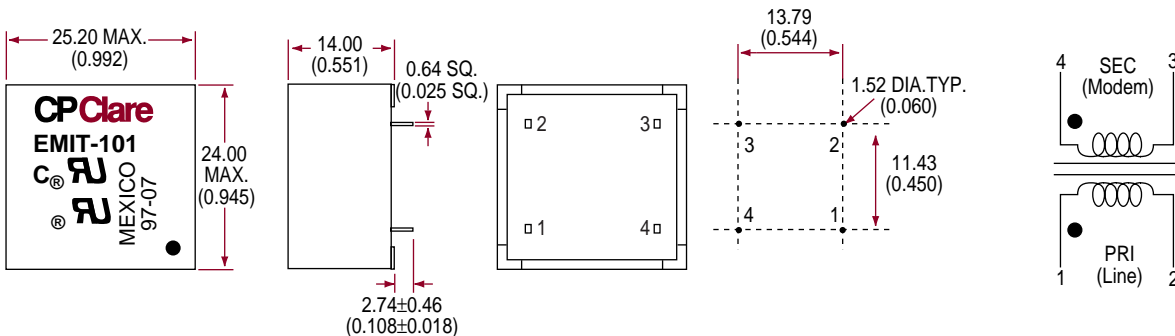

ELECTRICAL PERFORMANCE SPECIFICATIONS

Electrical Performance Specifications ($T_A = 25^\circ\text{C}$ unless otherwise specified)¹

PARAMETERS	CONDITIONS	MIN	TYP	MAX	UNITS
Impedance	Reflected on PRI	-	600	-	Ω
	With Load on SEC	-	470	-	Ω
Insertion Loss @ 20°C	Per IEEE method; @1000Hz	-	-	2.50	dB
Return Loss	200Hz - 500Hz	5	-	-	dB
	500Hz - 4000Hz	8	-	-	dB
Input/Output Isolation	-	4000	-	-	V_{RMS}
Frequency Response	300Hz - 600Hz	-	± 4.00	-	dB
	600Hz - 4000Hz	-	± 1.00	-	dB
Longitudinal Balance	Per FCC part 68.310				
	60Hz - 1000Hz	66	-	-	dB
	1000Hz - 4000Hz	46	-	-	dB
DC Resistance @ 20°C; $\pm 10\%$	Primary Winding	-	108	-	Ω
	Secondary Winding	-	120	-	Ω
DC Current in Primary	-	-	100	-	mADC
Turns Ratio	PRI to SEC; $\pm 2\%$	-	1.00:1.00	-	Turns
Operating Temperature	-	-40	-	+105	$^\circ\text{C}$
Storage Temperature	-	-40	-	+125	$^\circ\text{C}$
Soldering Temperature	10 Sec. Max.	-	-	+260	$^\circ\text{C}$

¹ All specifications are applicable from -20 to +4 dBm, 0 to 100 mADC in PRI.

ENCAPSULATED MODEM ISOLATION TRANSFORMERS

EMIT-600



DESCRIPTION

The CP Clare EMIT-600 Encapsulated Modem Isolation Transformer is a low-cost "Wet" modem coupler suitable for International V.32 9.6k fax, DBS/Set-top, CTI, POS, security and metering applications. Low-cost alternative coupler for auxiliary phone on international consumer and internet applications.

FEATURES

- Suitable for modem speeds up to V.32 (9.6k) and voice
- Cost-effective "Wet" coupler construction reduces DAA components
- 3750 V_{RMS} dielectric input/output isolation (IEC950 Reinforced)
- Matches 600Ω and complex impedance telephone lines
- Uses a minimum of external components for impedance matching
- Small PCB footprint (18.3mm x 18.3mm)

APPROVALS

- UL/C-UL recognized file number: E171120
- BSI certificate number: 8047 and 8048

NOMENCLATURE

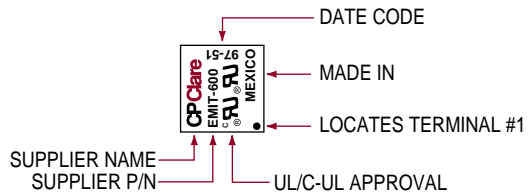

MECHANICAL DIMENSIONS

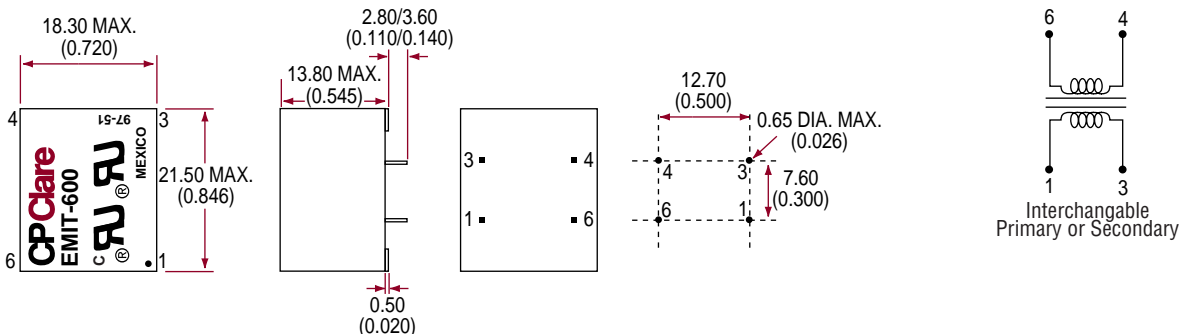

ELECTRICAL PERFORMANCE SPECIFICATIONS

Electrical Performance Specifications ($T_A = 25^\circ\text{C}$ unless otherwise specified)

PERFORMANCE PARAMETER	CONDITIONS	MIN	TYP	MAX	UNITS
Impedance	Reflected on PRI	-	600	-	Ω
	With Load on SEC & Comp. circuit	-	560	-	Ω
Insertion Loss, @ 20°C	Per IEEE method; @ 2000Hz	-	-	2.5	dB
Return Loss	1000Hz	8	-	-	dB
Input/Output Isolation	-	3750	-	-	V_{RMS}
Frequency Response	300Hz - 600Hz	-	± 6.0	-	dB
	600Hz - 4000Hz	-	± 1.0	-	dB
Longitudinal Balance	Per FCC part 68.310				
	60Hz - 1000Hz	60	-	-	dB
	1000Hz - 4000Hz	40	-	-	dB
DC Resistance @ 20°C; $\pm 10\%$	Primary Winding	-	67	-	Ω
	Secondary Winding	-	67	-	Ω
DC Current in Primary	-	-	50	-	mADC
Turns Ratio	Pri to Sec, $\pm 2\%$	-	1.00:1.00	-	Turns
Operating Temperature	-	-40	-	+105	$^\circ\text{C}$
Storage Temperature	-	-40	-	+125	$^\circ\text{C}$
Soldering Temperature	10 Sec. Max	-	-	+260	$^\circ\text{C}$

ENCAPSULATED MODEM ISOLATION TRANSFORMERS

EMIT-1200



DESCRIPTION

The CP Clare EMIT-1200 Encapsulated Modem Isolation Transformer is a low-cost "Dry" modem coupler suitable for international V.32bis 14.4k consumer, internet and CTI applications.

FEATURES

- Suitable for modem speeds up to V.32bis (14.4k)
- Total Harmonic Distortion rated -76dB max. @600Hz, -10dBm
- 3750 V_{RMS} dielectric input/output isolation (IEC950 Reinforced)
- Matches 600Ω and complex impedance telephone lines
- Uses a minimum of external components for impedance matching
- Small PCB footprint (18.3mm x 18.3mm)

APPROVALS

- UL/C-UL recognized file number: E171120
- BSI certificate number: 8047 and 8048

NOMENCLATURE

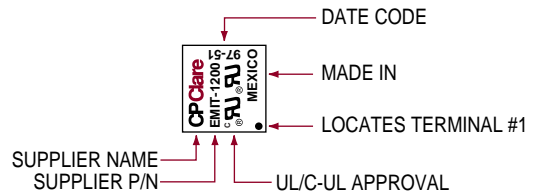

MECHANICAL DIMENSIONS

DIMENSIONS
mm
(inches)

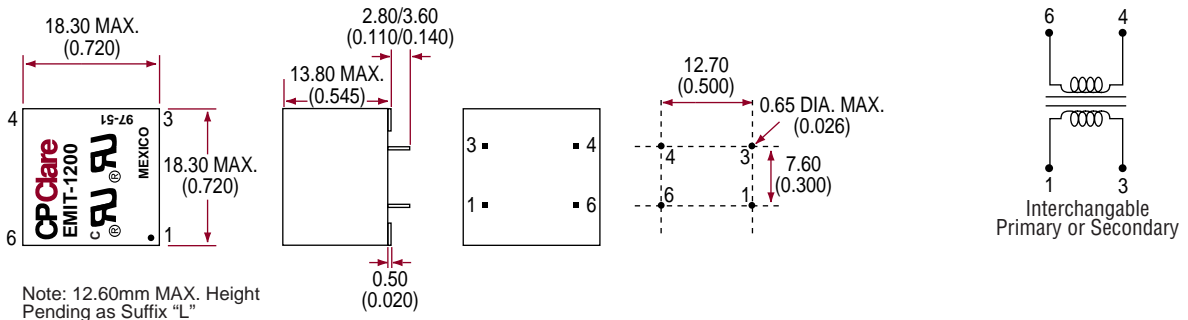

ELECTRICAL PERFORMANCE SPECIFICATIONS

Electrical Performance Specifications ($T_A = 25^\circ\text{C}$ unless otherwise specified)

PERFORMANCE PARAMETER	CONDITIONS	MIN	TYP	MAX	UNITS
Impedance	Reflected on PRI	-	600	-	Ω
	With Load on SEC	-	560	-	Ω
Total Harmonic Distortion	@ 600Hz, -10dBm	-	-	-76	dB
Insertion Loss	@ 2kHz $R_L = 560\Omega$	-	-	1.5	dB
Return Loss	200Hz - 4000Hz	18	24	-	dB
Input/Output Isolation	-	3750	-	-	V_{RMS}
Frequency Response	200Hz - 4000Hz	-	± 0.20	-	dB
Longitudinal Balance	200Hz - 1000Hz	60	-	-	dB
	1000Hz - 4000Hz	40	-	-	dB
DC Resistance @20°C; $\pm 10\%$	Primary Winding	-	67	-	Ω
	Secondary Winding	-	67	-	Ω
DC Current in Primary	-	-	-	0	mADC
Turns Ratio	Pri to Sec, $\pm 2\%$	-	1.00:1.00	-	Turns
Operating Temperature	-	-40	-	+105	$^\circ\text{C}$
Storage Temperature	-	-40	-	+125	$^\circ\text{C}$
Soldering Temperature	10 Sec. Max	-	-	260	$^\circ\text{C}$

ENCAPSULATED MODEM ISOLATION TRANSFORMERS

EMIT-2001



DESCRIPTION

The CP Clare EMIT-2001 Encapsulated Modem Isolation Transformer is a low distortion “Dry” modem coupler suitable for international performance V.34+ 33.6k consumer and internet applications.

FEATURES

- Suitable for modem speeds up to V.34+ (33.6k)
- Total Harmonic Distortion rated -82dB max. @600Hz, -10dBm
- 3750 V_{RMS} dielectric input/output isolation (IEC950 Reinforced)
- Matches 600Ω and complex impedance telephone lines
- Uses a minimum of external components for impedance matching
- Small PCB footprint (18.3mm x 18.3mm)

APPROVALS

- UL/C-UL recognized file number: E171120
- BSI certificate number: 8047 and 8048

NOMENCLATURE

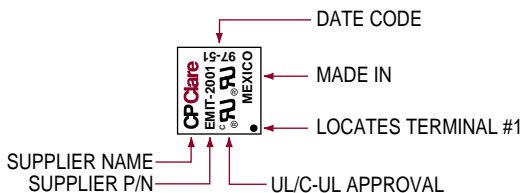

MECHANICAL DIMENSIONS

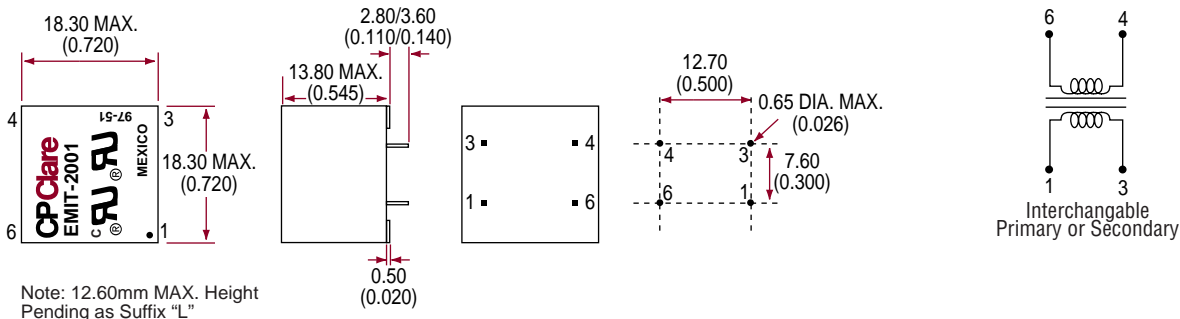

ELECTRICAL PERFORMANCE SPECIFICATIONS

Electrical Performance Specifications ($T_A = 25^\circ\text{C}$ unless otherwise specified)

PERFORMANCE PARAMETER	CONDITIONS	MIN	TYP	MAX	UNITS
Impedance	Reflected on PRI	-	600	-	Ω
	With Load on SEC	-	560	-	Ω
Total Harmonic Distortion	@ 600Hz, -10dBm	-	-	-82	dB
Insertion Loss	@ 2kHz	-	-	1.5	dB
	$R_L = 560\Omega$	-	-	-	-
Return Loss	200Hz - 4000Hz	18	24	-	dB
Input/Output Isolation	-	3750	-	-	V_{RMS}
Frequency Response	200Hz - 4000Hz	-	± 0.20	-	dB
Longitudinal Balance	200Hz - 1000Hz	60	-	-	dB
	1000Hz - 4000Hz	40	-	-	-
DC Resistance @20°C; $\pm 10\%$	Primary Winding	-	67	-	Ω
	Secondary Winding	-	67	-	Ω
DC Current in Primary	-	-	0	-	mADC
Turns Ratio	Pri to Sec, $\pm 2\%$	-	1.00:1.00	-	Turns
Operating Temperature	-	-40	-	+105	$^\circ\text{C}$
Storage Temperature	-	-40	-	+125	$^\circ\text{C}$
Soldering Temperature	10 Sec. Max	-	-	+260	$^\circ\text{C}$

ENCAPSULATED MODEM ISOLATION TRANSFORMERS

EMIT-2020



DESCRIPTION

The CP Clare EMIT-2020 Encapsulated Modem Isolation Transformer is a low distortion “Dry” modem coupler suitable for International V.90 56k consumer and internet applications. Simple “drop-in” upgrade for popular international couplers when migrating V.34+ 33.6k modems to V.90 56k technology.

FEATURES

- Suitable for modem speeds up to V.90 (56k) as “drop-in” upgrade from V.34+ (33.6k)
- Total Harmonic Distortion rated -82dB max. @600Hz, -10dBm
- Improves EMIT-2001 THD at low frequencies suitable for 56k European modems
- Insertion loss rated 1.5dB max. @ 2000Hz
- 3750 V_{RMS} dielectric input/output isolation (IEC950 Reinforced)
- Matches 600Ω and complex impedance telephone lines
- Uses a minimum of external components for impedance matching
- Small PCB footprint (18.3mm x 18.3mm)

APPROVALS

- UL/C-UL recognized file number: E171120
- BSI certificate number: 8047 and 8048

NOMENCLATURE

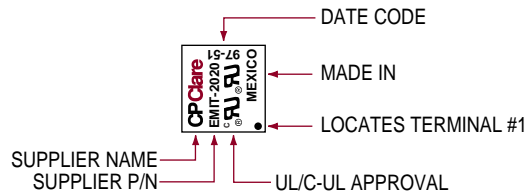

MECHANICAL DIMENSIONS

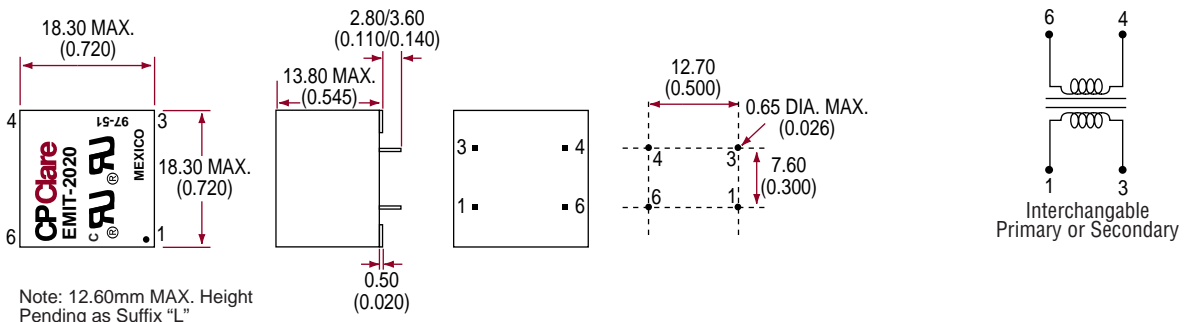

ELECTRICAL PERFORMANCE SPECIFICATIONS

Electrical Performance Specifications ($T_A = 25^\circ\text{C}$ unless otherwise specified)

PERFORMANCE PARAMETER	CONDITIONS	MIN	TYP	MAX	UNITS
Impedance	Reflected on PRI	-	600	-	Ω
	With Load on SEC	-	560	-	Ω
Total Harmonic Distortion	@ 600Hz, -10dBm	-	-	-86	dB
Insertion Loss	@ 2kHz $R_L = 560\Omega$	-	-	1.5	dB
Return Loss	200Hz - 4000Hz	18	24	-	dB
Input/Output Isolation	-	3750	-	-	V_{RMS}
Frequency Response	200Hz - 4000Hz	-	± 0.20	-	dB
Longitudinal Balance	200Hz - 1000Hz	60	-	-	dB
	1000Hz - 4000Hz	40	-	-	dB
DC Resistance @20°C; $\pm 10\%$	Primary Winding	-	67	-	Ω
	Secondary Winding	-	67	-	Ω
DC Current in Primary	-	-	0	-	mADC
Turns Ratio	Pri to Sec, $\pm 2\%$	-	1.00:1.00	-	Turns
Operating Temperature	-	-40	-	+105	$^\circ\text{C}$
Storage Temperature	-	-40	-	+125	$^\circ\text{C}$
Soldering Temperature	10 Sec. Max	-	-	+260	$^\circ\text{C}$

ENCAPSULATED MODEM ISOLATION TRANSFORMERS

EMIT-3020



DESCRIPTION

The CP Clare EMIT-3020 Encapsulated Modem Isolation Transformer is a very low distortion “Dry” modem coupler suitable for high-performance International V.90 56k consumer and internet applications.

FEATURES

- Suitable for modem speeds up to V.90 (56k)
- Total Harmonic Distortion rated -90dB max. @600Hz, -10dBm, and -75dB typ., @150Hz, -3dBm
- Insertion loss rated 2.0dB max. @ 2000Hz
- 3750 V_{RMS} dielectric input/output isolation (IEC950 Reinforced)
- Matches 600Ω and complex impedance telephone lines
- Uses a minimum of external components for impedance matching
- Small PCB footprint (18.3mm x 18.3mm)

APPROVALS

- UL/C-UL recognized file number: E171120
- BSI certificate number: 8047 and 8048

NOMENCLATURE

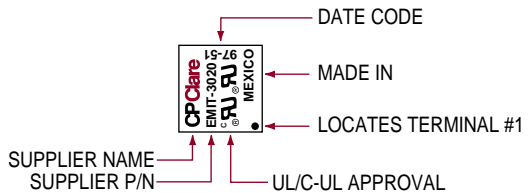

MECHANICAL DIMENSIONS

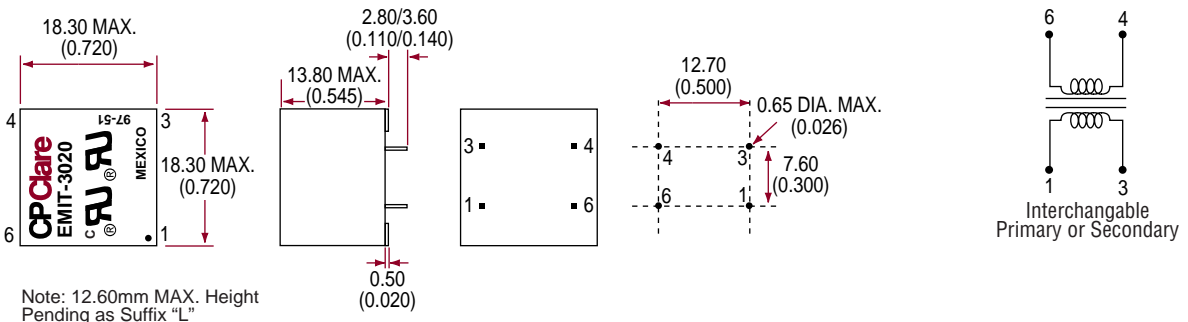

ELECTRICAL PERFORMANCE SPECIFICATIONS

Electrical Performance Specifications ($T_A = 25^\circ\text{C}$ unless otherwise specified)

PERFORMANCE PARAMETER	CONDITIONS	MIN	TYP	MAX	UNITS
Impedance	Reflected on PRI	-	600	-	Ω
	With Load on SEC	-	560	-	Ω
Total Harmonic Distortion	@ 150Hz, -3dBm	-	-75	-	dB
	@ 600Hz, -10dBm	-	-	-90	dB
Insertion Loss, @20°C	Per IEEE method; @ 2000Hz $R_L=560\Omega$	-	-	2.0	dB
Return Loss	1000Hz - 4000Hz	18	-	-	dB
Input/Output Isolation	-	3750	-	-	V_{RMS}
Frequency Response	200Hz - 4000Hz	-	± 0.40	-	dB
Longitudinal Balance	Per FCC part 68.310	-	-	-	-
	200Hz - 1000Hz	60	-	-	dB
	1000Hz - 4000Hz	40	-	-	dB
DC Resistance @ 20°C; $\pm 10\%$	Primary Winding	-	100	-	Ω
	Secondary Winding	-	100	-	Ω
DC Current in Primary	-	-	0	-	mADC
Turns Ratio	Pri to Sec, $\pm 2\%$	-	1.00:1.00	-	Turns
Operating Temperature	-	-40	-	+105	$^\circ\text{C}$
Storage Temperature	-	-40	-	+125	$^\circ\text{C}$
Soldering Temperature	10 Sec. Max	-	-	+260	$^\circ\text{C}$

SMT MODEM ISOLATION TRANSFORMERS

SMIT-204



DESCRIPTION

The CP Clare SMIT-204 SMT Modem Isolation Transformer is a "Dry" modem coupler suitable for domestic V.32bis 14.4k consumer, internet and CTI applications requiring surface-mount or PCMCIA profile.

FEATURES

- Suitable for modem speeds up to V.32bis (14.4k)
- Total Harmonic Distortion rated -76dB max. @ 600Hz, -10dBm
- 1250 V_{RMS} dielectric input/output isolation
- Reflects 600Ω on Primary with 294Ω on Secondary
- Surface mount footprint (19.8mm x 16.3mm)
- PCMCIA profile (4.32mm)
- SMT pin configurations

APPROVALS

- UL/C-UL recognized file number: E171120

NOMENCLATURE

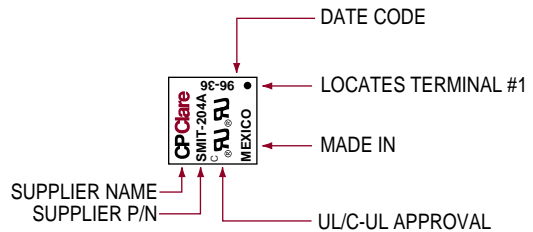

MECHANICAL DIMENSIONS

DIMENSIONS
mm
(inches)

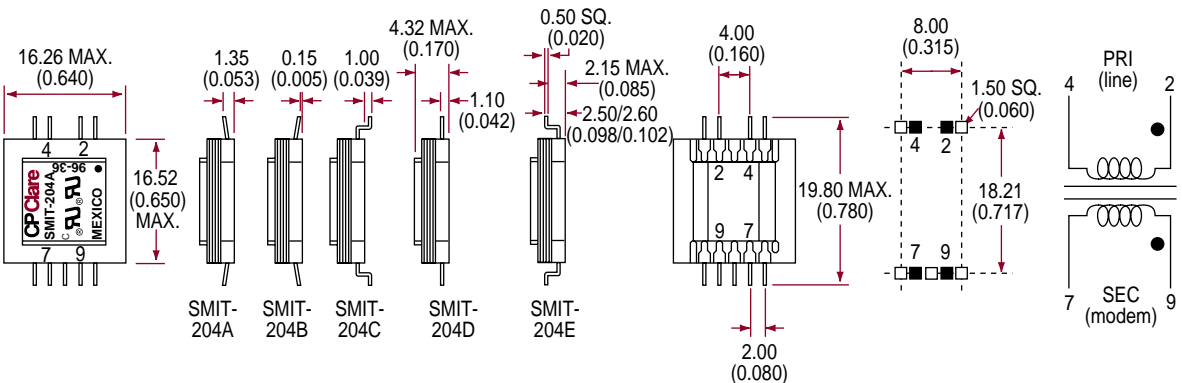

ELECTRICAL PERFORMANCE SPECIFICATIONS

Electrical Performance Specifications ($T_A = 25^\circ\text{C}$ unless otherwise specified)

PERFORMANCE PARAMETER	CONDITIONS	MIN	TYP	MAX	UNITS
Impedance	Reflected on PRI	-	600	-	Ω
	With Load on SEC	-	294	-	Ω
Total Harmonic Distortion	@ 600Hz, -10dBm	-	-	-76	dB
Insertion Loss	@ 1kHz	2.90	3.15	3.40	dB
Return Loss	300Hz-4000Hz	25	-	-	dB
Input/Output Isolation	-	1250	-	-	V_{RMS}
Frequency Response	200Hz - 4000Hz	-	± 0.25	-	dB
Longitudinal Balance	200Hz - 1000Hz	60	-	-	dB
	1000Hz - 4000Hz	40	-	-	dB
DC Resistance @ $20^\circ\text{C}; \pm 10\%$	Primary Winding	-	156	-	Ω
	Secondary Winding	-	145	-	Ω
DC Current in Primary	-	-	0	-	mADC
Turns Ratio	Pri to Sec, $\pm 2\%$	-	1.00:1.00	-	Turns
Operating Temperature	-	-40	-	+105	$^\circ\text{C}$
Storage Temperature	-	-40	-	+125	$^\circ\text{C}$
Soldering Temperature	10 Sec. Max	-	-	+260	$^\circ\text{C}$



DESCRIPTION

The CP Clare SMIT-304 SMT Modem Isolation Transformer is a low distortion "Dry" modem coupler suitable for domestic V.34+ 33.6k consumer and internet applications requiring surface-mount or PCMCIA profile.

FEATURES

- Suitable for modem speeds up to V.34+ (33.6k)
- Total Harmonic Distortion rated -82dB max. @ 600Hz, -10dBm
- 1250 V_{RMS} dielectric input/output isolation (UL1459)
- Reflects 600Ω on Primary with 294Ω on Secondary
- Surface mount footprint (19.8mm x 16.3mm)
- PCMCIA profile (4.32mm)
- SMT pin configurations

APPROVALS

- UL/C-UL recognized file number: E171120

NOMENCLATURE

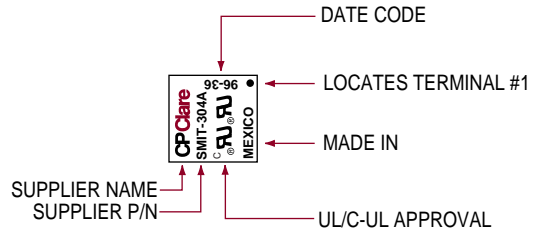

MECHANICAL DIMENSIONS

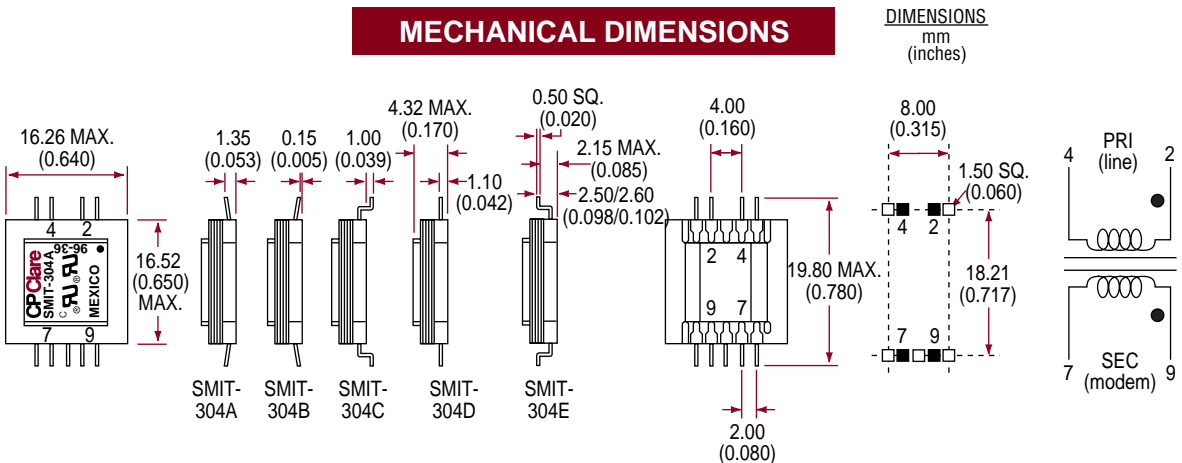

ELECTRICAL PERFORMANCE SPECIFICATIONS

Electrical Performance Specifications ($T_A = 25^\circ\text{C}$ unless otherwise specified)

PARAMETERS	CONDITIONS	MIN	TYP	MAX	UNITS
Impedance	Reflects on PRI	-	600	-	Ω
	With Load on SEC	-	294	-	Ω
Total Harmonic Distortion	@ 600Hz, -10dBm	-	-	-82	dB
Insertion Loss	@ 1kHz	2.90	3.15	3.40	dB
Return Loss	300Hz - 4000Hz	25	-	-	dB
Input/Output Isolation	-	1250	-	-	V_{RMS}
Frequency Response	200Hz - 4000Hz	-	± 0.25	-	dB
Longitudinal Balance	200Hz - 1000Hz	60	-	-	dB
	1000Hz - 4000Hz	40	-	-	dB
DC Resistance @20°C; $\pm 10\%$	Primary Winding	-	156	-	Ω
	Secondary Winding	-	145	-	Ω
DC Current in Primary	-	-	0	-	mADC
Turns Ratio	PRI to SEC; $\pm 2\%$	-	1.00:1.00	-	Turns
Operating Temperature	-	-40	-	+105	$^\circ\text{C}$
Storage Temperature	-	-40	-	+125	$^\circ\text{C}$
Soldering Temperature	10 Sec. Max.	-	-	+260	$^\circ\text{C}$

SMT MODEM ISOLATION TRANSFORMERS

SMIT-314



DESCRIPTION

The CP Clare SMIT-314 Series SMT Modem Isolation Transformer is a low distortion “Dry” modem coupler suitable for international V.34+ 33.6k consumer and internet applications requiring surface-mount or PCMCIA profile.

FEATURES

- Suitable for modem speeds up to V.34+ (33.6k)
- Total Harmonic Distortion rated -80dB max. @ 600Hz, -10dBm
- 2000 V_{RMS} dielectric input/output isolation (IEC950 Supplementary)
- Reflects 600Ω on Primary with 294Ω on Secondary
- Surface mount footprint (19.8mm x 16.3mm)
- PCMCIA profile (4.32mm)
- SMT pin configurations

APPROVALS

- UL/C-UL recognized file number: Pending
- BSI certificate number: 8122

NOMENCLATURE

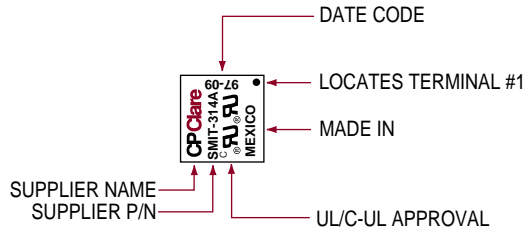

MECHANICAL DIMENSIONS

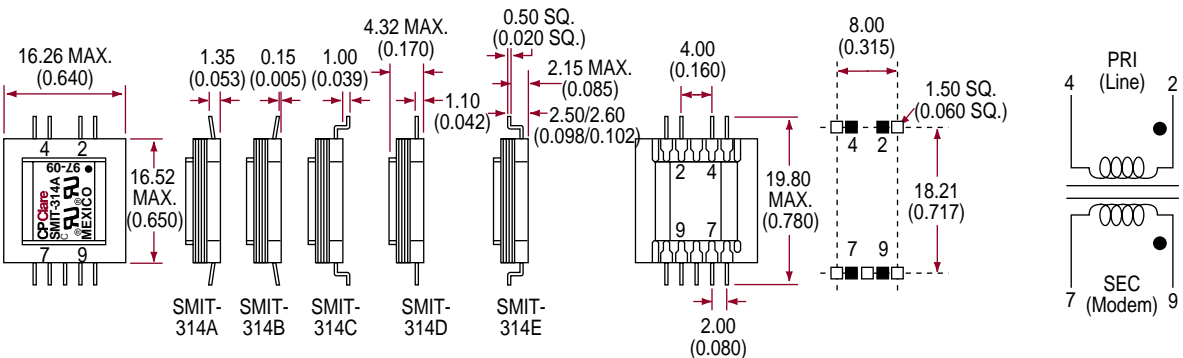

ELECTRICAL PERFORMANCE SPECIFICATIONS

Electrical Performance Specifications (T_A = 25°C unless otherwise specified)

PARAMETERS	CONDITIONS	MIN	TYP	MAX	UNITS
Impedance	Reflects on PRI	-	600	-	Ω
	With Load on SEC	-	294	-	Ω
Total Harmonic Distortion	@ 600Hz, -10dBm	-	-	-80	dB
Insertion Loss @ 20°C; ± 0.5dB	Per IEEE method; @ 1000Hz	3.00	3.50	4.00	dB
Return Loss	300Hz - 3000Hz	15	-	-	dB
Input/Output Isolation	-	2000	-	-	V _{RMS}
Frequency Response	200Hz - 4000Hz	-	± 0.25	-	dB
Longitudinal Balance	Per FCC part 68.310				
	60Hz - 1000Hz	60	-	-	dB
	1000Hz - 4000Hz	40	-	-	dB
DC Resistance @ 20°C; ± 10%	Primary Winding	-	270	-	Ω
	Secondary Winding	-	295	-	Ω
DC Current in Primary	-	-	0	-	mADC
Turns Ratio	PRI to SEC; ± 2%	-	1.00:1.00	-	Turns
Operating Temperature	-	-40	-	+105	°C
Storage Temperature	-	-40	-	+125	°C
Soldering Temperature	10 Sec. Max.	-	-	+260	°C



DESCRIPTION

The CP Clare SMIT-2393 Series SMT Modem Isolation Transformer is a low distortion, "Dry" modem coupler suitable for international V.34+ 33.6k consumer and internet applications requiring surface mount or PCMCIA profile.

FEATURES

- Suitable for modem speeds up to V.34+ (33.6k)
- Total Harmonic Distortion rated -82dB max. @ 600Hz, -10dBm
- 2000 V_{RMS} dielectric input/output isolation (IEC950 Supplementary)
- Reflects 600Ω on Primary with 294Ω on Secondary
- Surface mount footprint (19.8mm x 16.3mm)
- PCMCIA profile (4.32mm)
- SMT pin configurations

APPROVALS

- UL/C-UL recognized file number: Pending
- BSI certificate number: Pending

NOMENCLATURE

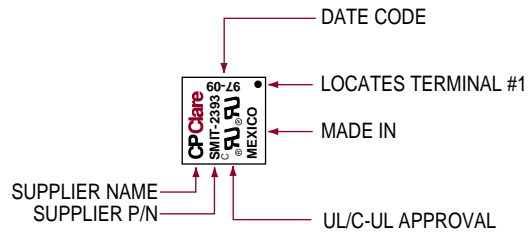

MECHANICAL DIMENSIONS

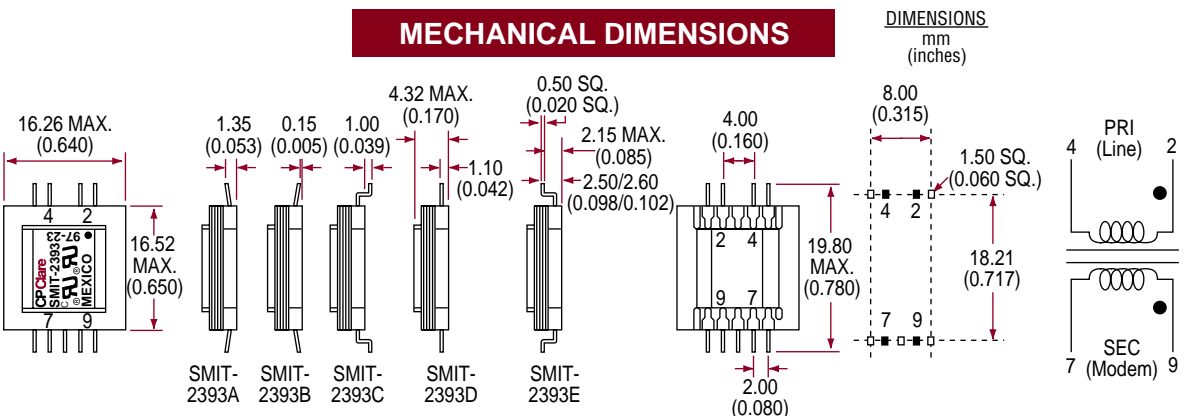

ELECTRICAL PERFORMANCE SPECIFICATIONS

Electrical Performance Specifications ($T_A = 25^\circ\text{C}$ unless otherwise specified)

PARAMETERS	CONDITIONS	MIN	TYP	MAX	UNITS
Impedance	Reflected on PRI	-	600	-	Ω
	With Load on SEC	-	294	-	Ω
Total Harmonic Distortion	@ 600Hz, -10dBm	-	-	-82	dB
Insertion Loss, @ 20°C	Per IEEE method; @ 1000Hz	2.95	3.2	3.45	dB
Return Loss	300Hz - 3500Hz	20	-	-	dB
Input/Output Isolation	-	2000	-	-	V_{RMS}
Frequency Response	200Hz - 4000Hz	-	± 0.25	-	dB
Longitudinal Balance	Per FCC part 68.310				
	300Hz - 1000Hz	60	-	-	dB
	1000Hz - 4000Hz	40	-	-	dB
DC Resistance, @ 20°C; $\pm 10\%$	Primary Winding	-	145	-	Ω
	Secondary Winding	-	160	-	Ω
DC Current in Primary	-	-	0	-	mADC
Turns Ratio	Pri to Sec; $\pm 2\%$	-	1.00:1.00	-	Turns
Operating Temperature	-	-40	-	+105	$^\circ\text{C}$
Storage Temperature	-	-40	-	+125	$^\circ\text{C}$
Soldering Temperature	10 Sec. Max.	-	-	+260	$^\circ\text{C}$



DESCRIPTION



The CP Clare SMIT-2412 SMT Modem Isolation Transformer is a low distortion “Dry” modem coupler suitable for domestic V.34+ 33.6k consumer and internet applications requiring PCMCIA profile in a remarkably small footprint.

FEATURES

- Suitable for modem speeds up to V.34+ (33.6k)
- Total Harmonic Distortion rated -80dB max. @ 600Hz, -10dBm
- 1250 V_{RMS} dielectric input/output isolation (UL1459)
- Reflects 600Ω on Primary with 301Ω on Secondary
- PCMCIA profile (4.31mm)
- Ultra-small footprint (15.9mm x 8.3mm)

APPROVALS

- UL/C-UL recognized file number: Pending

NOMENCLATURE

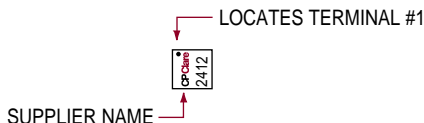

MECHANICAL DIMENSIONS

DIMENSIONS
mm
(inches)

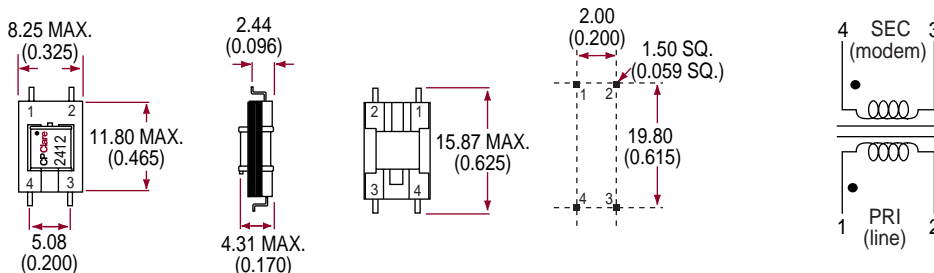

ELECTRICAL PERFORMANCE SPECIFICATIONS

Electrical Performance Specifications (T_A = 25°C unless otherwise specified)

PARAMETERS	CONDITIONS	MIN	TYP	MAX	UNITS
Impedance	Reflected on PRI	-	600	-	Ω
	With Load on SEC	-	301	-	Ω
Total Harmonic Distortion	@ 600Hz, -10dBm	-	-	-80	dB
Insertion Loss @ 20°C	Per IEEE method; @ 1000Hz	3.05	3.30	3.55	dB
Return Loss	300Hz - 3500Hz	25	-	-	dB
Input/Output Isolation	-	1250	-	-	V _{RMS}
Frequency Response	300Hz - 3500Hz	-	± 0.15	-	dB
Longitudinal Balance	Per FCC part 68.310				
	200Hz - 1000Hz	60	-	-	dB
	1000Hz - 4000Hz	40	-	-	dB
DC Resistance @ 20°C; ± 10%	Primary Winding	-	140	-	Ω
	Secondary Winding	-	160	-	Ω
DC Current in Primary	-	-	0	-	mADC
Turns Ratio	Pri to Sec; ± 2%	-	1.00:1.00	-	Turns
Operating Temperature	-	-40	-	+105	°C
Storage Temperature	-	-40	-	+125	°C
Soldering Temperature	10 Sec. Max.	-	-	+260	°C

ENCAPSULATED SMT MODEM ISOLATION TRANSFORMERS

ESMIT-100



DESCRIPTION

The CP Clare ESMIT-100 Encapsulated SMT Modem Isolation Transformer is a "Dry" modem coupler suitable for international V.32bis 14.4k consumer and internet applications requiring surface-mount or small footprint.

FEATURES

- Suitable for modem speeds up to V.32bis (14.4k)
- Total Harmonic Distortion rated -76dB max. @600Hz, -10dBm
- 4600 V_{RMS} dielectric input/output isolation (IEC950 Reinforced)
- Matches 600Ω and complex impedance telephone lines
- Uses a minimum of external components for impedance matching
- Very small PCB footprint (12.4mm x 9.6mm)
- Very low profile (7mm)
- SMT

APPROVALS

- UL/C-UL recognized file number: Pending
- BSI certificate number: 8264

NOMENCLATURE

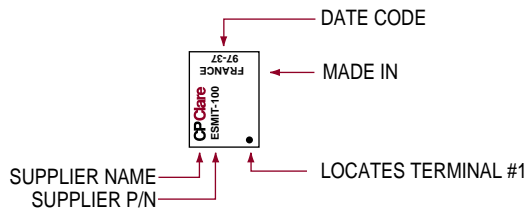

MECHANICAL DIMENSIONS

DIMENSIONS
mm
(inches)

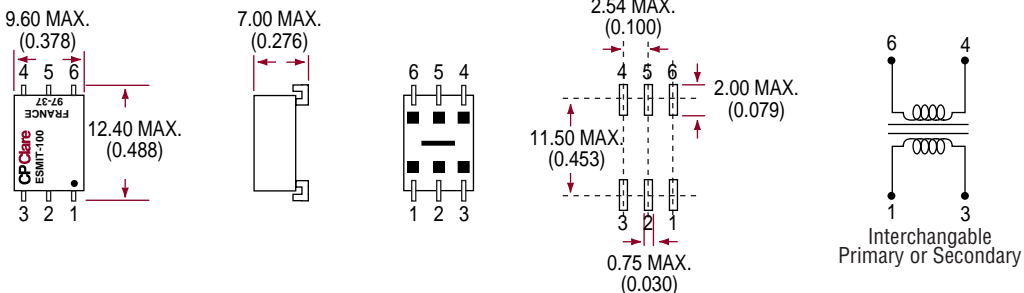

ELECTRICAL PERFORMANCE SPECIFICATIONS

Electrical Performance Specifications ($T_A = 25^\circ\text{C}$ unless otherwise specified)

PARAMETERS	CONDITIONS	MIN	TYP	MAX	UNITS
Impedance	Reflected on PRI	-	600	-	Ω
	With Load on SEC	-	330	-	
Total Harmonic Distortion	@ 600Hz, -10dBm	-	-	-76	dB
Insertion Loss, @ 20°C	Per IEEE method; @ 2000Hz	-	-	2.0	dB
Return Loss	200Hz - 4000Hz With Optimised Assembly	24	-	-	dB
Input/Output Isolation	-	4600	-	-	V_{RMS}
Frequency Response	200Hz - 4000Hz	-	± 0.25	-	dB
Longitudinal Balance	Per FCC part 68.310 60Hz - 4000Hz	80	-	-	dB
DC Resistance, @ 20°C; $\pm 15\%$	Primary Winding	-	115	-	Ω
	Secondary Winding	-	115	-	Ω
DC Current in Primary	-	-	0	-	mADC
Shunt Loss	@ 200Hz, -43dBm	7500	-	-	Ω
Insulation Resistance	@ 500V	-	500	-	M Ω
Turns Ratio	Pri to Sec; $\pm 2\%$	-	1.00:1.00	-	Turns
Operating Temperature	-	0	-	+70	$^\circ\text{C}$
Storage Temperature	-	-40	-	+125	$^\circ\text{C}$
Soldering Temperature	10 Sec. Max. Suitable for IR Reflow	-	-	+240	$^\circ\text{C}$

ESMIT-100 Optimal Usage

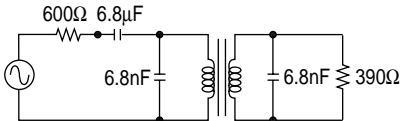

ESMIT-100 Schematic Equivalent

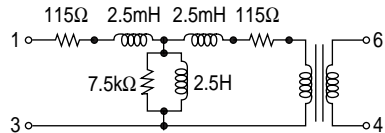

ENCAPSULATED SMT MODEM ISOLATION TRANSFORMERS

ESMIT-300



DESCRIPTION

The CP Clare ESMIT-300 Encapsulated SMT Modem Isolation Transformer is a low distortion “Dry” modem coupler suitable for international V.34+ 33.6k consumer and internet applications, requiring surface-mount or small footprint.

FEATURES

- Suitable for modem speeds up to V.34+ (33.6k)
- Total Harmonic Distortion rated -82dB max. @ 600Hz, -10dBm
- 4600 V_{RMS} dielectric input/output isolation (IEC950 Reinforced)
- Matches 600Ω and complex impedance telephone lines
- Uses a minimum of external components for impedance matching
- Very small PCB footprint (12.4mm x 9.6mm)
- Very low profile (7mm)
- SMT

APPROVALS

- UL/C-UL recognized file number: Pending
- BSI certificate number: 8264

NOMENCLATURE

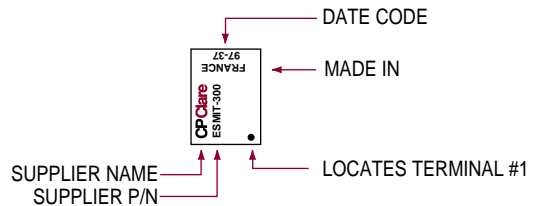

MECHANICAL DIMENSIONS

DIMENSIONS
mm
(inches)

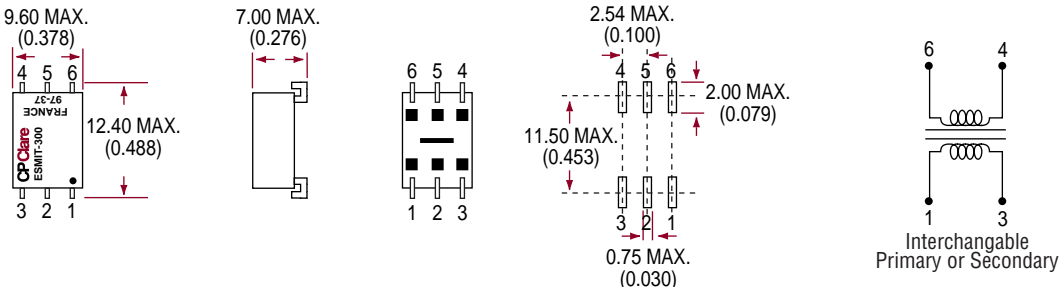

ELECTRICAL PERFORMANCE SPECIFICATIONS

Electrical Performance Specifications ($T_A = 25^\circ\text{C}$ unless otherwise specified)

PARAMETERS	CONDITIONS	MIN	TYP	MAX	UNITS
Impedance	Reflected on PRI	-	600	-	Ω
	With Load on SEC	-	330	-	Ω
Total Harmonic Distortion	@ 600Hz, -10dBm	-	-	-82	dB
Insertion Loss, @ 20°C	Per IEEE method; @ 2000Hz	-	-	2.5	dB
Return Loss	200Hz - 4000Hz With Optimised Assembly	24	-	-	dB
Input/Output Isolation	-	4600	-	-	V_{RMS}
Frequency Response	200Hz - 4000Hz	-	± 0.20	-	dB
Longitudinal Balance	Per FCC part 68.310 60Hz - 4000Hz	80	-	-	dB
DC Resistance, @ 20°C; $\pm 15\%$	Primary Winding	-	150	-	Ω
	Secondary Winding	-	150	-	Ω
DC Current in Primary	-	-	0	-	mADC
Shunt Loss	@ 200Hz, -43dBm	10,000	-	-	Ω
Insulation Resistance	@ 500V	-	500	-	M Ω
Turns Ratio	Pri to Sec; $\pm 2\%$	-	1.00:1.00	-	Turns
Operating Temperature	-	0	-	+70	$^\circ\text{C}$
Storage Temperature	-	-40	-	+125	$^\circ\text{C}$
Soldering Temperature	10 Sec. Max. Suitable for IR Reflow	-	-	+240	$^\circ\text{C}$

**ESMIT-300 Optimal Circuit
(Z=600 Ω)**

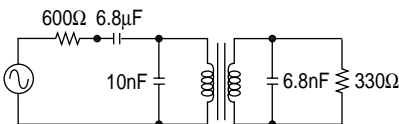

**ESMIT-300 Optimal Circuit
(Z=European Complex Impedance)**

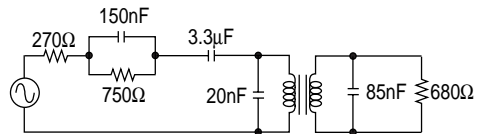

ESMIT-300 Schematic Equivalent

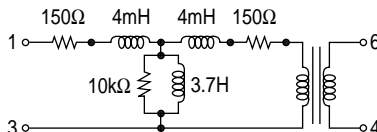

Modem Isolation Transformers

Modem Isolation Transformers

Basic Function of the Modem Isolation Transformer

Modem Isolation Transformers (MIT's) provide three essential functions within the telecommunications network. First, the MIT must provide electrical isolation between two telecom circuits. Second, the MIT must provide audio coupling between the two telecom circuits. And third, the MIT must provide impedance matching between the two telecom circuits. On an elementary level, the MIT consists of a primary (input) winding and a secondary (output) winding which are electrically isolated and magnetically coupled. The challenge of designing a Modem Isolation Transformer is to optimize these performance factors in order to best meet the requirements of the application.

The first function of the MIT is to provide electrical isolation between two telecom circuits. This electrical isolation essentially protects the communication network from any failure of any device which is connected to the line. Due to the size and complexity of the telecommunications network, this electrical isolation is required to maintain the network's integrity and reliability. This isolation is necessary so that the millions of devices which are connected to the telecommunications network (telephones, modems, answering machines, voice-mail systems, fax machines, etc.) cannot adversely affect the overall telecom network. With respect to electrical isolation, the ideal MIT would have infinite dielectric protection between its input and output windings. In practice, isolation ratings of 1,250V_{AC} to 3,750V_{AC} are common in the industry. The required level of electrical isolation is determined by the controlling regulatory agency for the specific telecom network in question.

In addition to providing electrical isolation, the MIT must perform an audio coupling function, which allows the consistent transmission of signals from one telecom circuit to another. The ability of a MIT to transmit signals from one telecom circuit to another is characterized by several measurable parameters, which are explained in more detail below. Basically, though, it is fairly accurate to say that an ideal MIT can be characterized by perfect primary-to-secondary coupling, zero distortion, and zero power losses. In practice, the trade-

offs between these performance parameters determines how precisely a specific MIT component matches a specific application. The audio performance parameters include:

- Insertion Loss
- Frequency Response
- Return Loss
- Longitudinal Balance
- Total Harmonic Distortion

Audio Performance of MIT's

The critical coupling characteristics of the MIT are discussed in this section. Definitions of each of these parameters are provided, as well as discussing their relative importance to the function of the MIT, and techniques on how to measure them.

Impedance. Impedance is the ratio of the AC voltage over the AC current, for any AC electric circuit. Impedance matching along the telecommunications network is critical to the function of the network. Improper impedances can create unwanted reflections and echoes, resulting in delays in voice communications and errors in data transmissions.

Figure 1 shows a very simple circuit which can be utilized to measure the primary impedance of a modem isolation transformer.

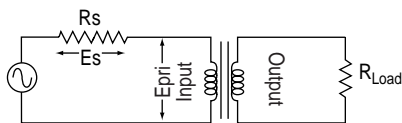

$$\text{Impedance} = Z_{pri} = \left| \frac{E_{pri}}{E_s} \right| R_s$$

Figure 1. Impedance Relationship

Modem Isolation Transformers

Insertion Loss. The insertion loss of a transformer is defined as the ratio of the power delivered to the load with and without the transformer inserted into the circuit. The following explanation of insertion loss is valid when the load impedance is equal to the source impedance.

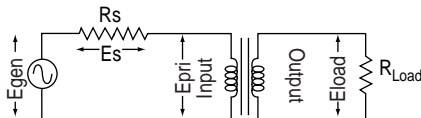

$$\text{Insertion Loss (dB)} = 10 \log_{10} \left| \frac{(E_{gen})^2 R_{load}}{4(E_{load})^2 R_s} \right|$$

Figure 2. Insertion Loss Relationship

Referring to the insertion loss equation, the numerator is simply the maximum power available from the source, and the denominator is simply the power delivered to the load with the transformer inserted into the circuit. Thus the term 'insertion loss'. The insertion loss actually consists of both the actual dissipative losses within the transformer and the 'losses' associated with the impedance mismatch between the input and output of the transformer.

Frequency Response. The frequency response of a transformer is defined as the variation in insertion loss as a function of frequency. The frequency response measurement is always made relative to a constant reference frequency. A typical modem isolation transformer for a high speed dry (no DC current) application will have a relatively flat response curve, varying less than +/- 0.5 dB over the normal operating frequency range.

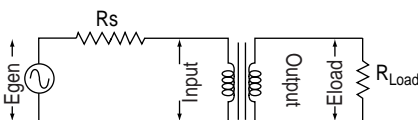

$$\text{Frequency Response (dB)} = 20 \log_{10} \left| \frac{E_{load}}{E_{load'}} \right|$$

E_{load} = Load Voltage at Test Frequency

$E_{load'}$ = Load Voltage at Mid-Band Reference Frequency

Figure 3. Frequency Response Relationship

Return Loss. Return loss is defined as the amount of the signal which is reflected back towards the source, rather than transmitted to the secondary and the load. This reflection is due to impedance mismatch within the MIT. The general equation for return loss is provided below.

$$\text{Return Loss (dB)} = 20 \log_{10} \left| \frac{Z_{ref} + Z_{net}}{Z_{ref} - Z_{net}} \right|$$

Z_{ref} = Reflected Primary Impedance With Secondary Loaded

Z_{net} = Reflected Impedance of the Telecom Network

Excessive return loss can cause reflections in telecom transmission lines. These reflections can cause echoes of the transmitted signals. These reflections can be annoying for voice communication and can introduce significant errors when transmitting data.

Longitudinal Balance. The longitudinal balance is the ratio of the metallic (differential) signal with respect to the longitudinal (common mode) signal appearing between the transformer's winding and ground. Poor longitudinal balance performance can cause audible hum, audible noise, and cross-talk rejection.

There are two widely accepted techniques for measuring longitudinal balance. One method, probably the most widely accepted technique, is found in the ANSI/IEEE 455-1985 Standard. A second, less commonly used technique can be found in the FCC 68.310 documentation.

Total Harmonic Distortion. The distortion of the MIT can be thought of as any change in the secondary signal (output) waveshape from the original primary (input) signal. In terms of harmonics, the total harmonic distortion is the sum of the power of all frequency components (excluding the fundamental frequency), divided by the power of the fundamental frequency. Significant distortion can cause problems with the signal transmission from one telecom circuit to another. The total harmonic distortion of the MIT can be a limiting factor for the transmission speed of the modem circuit. Due to the importance of this performance parameter, it is discussed in a separate section below.

Modem Isolation Transformers

MIT Performance & Modem Speed

The transmission speed of a modem is a function of many different design parameters, ranging from the specific modem hardware employed to the specific data-compression software algorithms employed. The performance of the MIT is one of the hardware design aspects which constrain the modem's transmission speed. Specifically, the MIT's signal distortion is the main constraint on modem speed. The distortion of the MIT can be thought of as any change in the waveshape between the secondary (output) signal from the original primary (input) signal. Significant distortion can cause problems with the signal transmission from one telecom circuit to another.

The distortion of the MIT can be caused by many factors, but is especially sensitive to the performance of the magnetic lamination within the MIT. To assist the design engineer, the following table relates the transmission baud rate, the ITU designation, and the maximum allowable THD (total harmonic distortion) of the Modem Isolation Transformer.

As the actual modem transmission speed is a function of many variables, this table is meant to be used as a general guideline relating THD and baud rate. Due to the many external variables, we cannot guarantee that a particular CP Clare MIT will meet a specific baud rate in a particular modem application.

Data Speed (Baud Rate)	ITU Designation	Max THD (600Hz, -10dBm)	CP Clare MIT PN's
9600	V.32	-71 dB	MIT-101, MIT-115
14,400	V.32bis	-76 dB	MIT-125
28,800 and 33,600	V.34	-82 dB	MIT-131, MIT-139
56,000	V.90	-82dB but also -75 dB max @ 150 Hz, -3 dBm	MIT-3262

Table 1. Total Harmonic Distortion & Modem Speeds

Classifications of MIT's

There exist four broad classifications of Modem Isolation Transformers. These four classifications are defined relative to the component's performance, size, and end-use application.

The first MIT classification is the traditional through-hole configuration which applies to most modem applications, including:

- External Modem Applications
- PC Motherboard Applications
- PC Expansion Card Applications

This major classification covers the complete range of modem performance, from low-end (slow) wet applications, to high-end (fast) dry applications.

The second MIT classification are components specifically designed for the very low-profile PCMCIA and SMT applications. These SMIT's utilize specially designed surface-mount bobbins and laminations to achieve the very demanding low-profile requirements of the PCMCIA configuration. These SMIT's are generally more on the high end of the performance range, typically running at 14,400 to 33,600 baud.

The third MIT classification are the components specifically designed for the demanding voltage isolation requirements of the European telecom markets. These EMIT's utilize unique bobbins and are generally potted or encapsulated to achieve voltage isolations as high as 3,750 volts.

The fourth MIT classification, for Europe, simply recognizes the SMT trend. These ESMIT's are encapsulated and configured with surface-mount pins.

For reference, a brief overview of the CP Clare MIT product line is provided in the table on the next page.

Modem Isolation Transformers

Application	Technology	CP Clare Device	Technology Guidelines			Application Attributes / Goals					
			Very Suitable	Known Adaptable	May Be Adaptable	Thru-Hole Mount	Surface Mount	Higher Performance	Lower Cost	Other	
Board Dry	V.90 56 kbps	MIT-3262	X			X		X		X	Real Value
Domestic		MIT-262	X			X		X			V.90 reference
		MIT-372		X		X				X	Low Ins. Loss
		MIT-131		X		X		X			
		MIT-125		X		X				X	
		MIT-538			X	X					Low Ins. Loss
		MIT-179			X	X					Hi-perf. V.34+
		MIT-139			X	X					Hi-perf. V.34+
	V.34+ 33.6 kbps	MIT-179	X			X		X			Cost < "139"
		MIT-139	X			X		X			
		MIT-131	X			X					V.34+ reference
		MIT-372		X		X				X	Low Ins. Loss
		MIT-125		X		X				X	
		MIT-538			X	X					Low Ins. Loss
	V.32bis 14.4 kbps	MIT-125	X			X		X			V.32bis reference
		MIT-538	X			X		X			Low Ins. Loss
		MIT-205		X		X					Real Value
Wet	V.34+ 33.6 kbps	MIT-205									
	V.32bis 14.4 kbps	MIT-205	X			X		X		X	
	V.32 9.6 kbps	MIT-115	X			X		X			
		MIT-115V	X			X		X			5kV transients
		MIT-101	X			X		X		X	V.32 reference
		MIT-101V	X			X		X		X	5kV transients
		MIT-600	X			X					Small size
		EMIT-101	X			X					4kV I/O Isolation

Note 1: The term "Very Suitable" means both theory and practical experience indicate to CP Clare that a device suits a modem type depicted above. The term "Known Adaptable" means CP Clare has witnessed systems designs using the device in the modem type. And "May Be Adaptable" means CP Clare knows competitors' versions of the same device have been claimed suitable to the modem type. Individual CP Clare data sheets tend to the industry-held beliefs shown on the above table as the "May Be Adaptable" column.

Note 2: Watch CP Clare's web site for future introductions of PCMCIA-profile transformers able to meet theoretical electrical requirements in order to truly provide fully V.90 (56-kbps) suitable PCMCIA-profile devices.

Modem Isolation Transformers

Application	Technology	CP Clare Device	Technology Guidelines			Application Attributes / Goals					
			Very Suitable	Known Adaptable	May Be Adaptable	Thru-Hole Mount	Surface Mount	Higher Performance	Lower Cost	Other	
PCMCIA or SMT	V.90	56 kbps	SMIT-304			X		X		X	See Note 2
Domestic	V.34+	33.6 kbps	SMIT-304	X				X		X	
			SMIT-2412		X			X			Very Small
	V.32bis	14.4 kbps	SMIT-204	X				X		X	
Board	V.90	56 kbps	EMIT-3020	X			X				
Int'l			EMIT-2020		X		X			X	V.34+ Drop-In
			EMIT-1200			X				X	
	V.34+	33.6 kbps	EMIT-2001	X			X				V.34+ Reference
			EMIT-1200			X				X	
			ESMIT-300	X			X				Small Size
	V.32bis	14.4 kbps	EMIT-1200	X			X				V.32bis Reference
			ESMIT-100	X			X				Small Size
	Wet	V.32	9.6 kbps	EMIT-600	X		X				Real Value
PCMCIA or SMT	V.34+	33.6 kbps	SMIT-2393	X			X		X		V.34+ Reference
Int'l			SMIT-314	X			X		X		

Note 1: The term "Very Suitable" means both theory and practical experience indicate to CP Clare that a device suits a modem type depicted above. The term "Known Adaptable" means CP Clare has witnessed systems designs using the device in the modem type. And "May Be Adaptable" means CP Clare knows competitors' versions of the same device have been claimed suitable to the modem type. Individual CP Clare data sheets tend to the industry-held beliefs shown on the above table as the "May Be Adaptable" column.

Note 2: Watch CP Clare's web site for future introductions of PCMCIA-profile transformers able to meet theoretical electrical requirements in order to truly provide fully V.90 (56-kbps) suitable PCMCIA-profile devices.

Single Pole OptoMOS® Relays



CP Clare's Single Pole OptoMOS® Relays devices are an integral part of Clare's growing family of optical solid state switching devices. These single output devices offer a variety of solutions within the telecommunication, industrial control, security and instrumentation industries. As replacements for 1-Form-A (normally open output) and 1-Form-B (normally closed output) mechanical relays, these devices utilize discrete semiconductor components as opposed to conventional coils and contacts. Unlike their electromechanical counterparts, there are no moving parts within these devices. Therefore, they can offer faster, more reliable, bounce-free switching in a much more compact through hole or surface mount package. Optical isolation ensures extremely high I/O isolation. Current limiting for added protection is available on some models.

Single Pole OptoMOS® Relays

Part Number	LCA100	LCA110	XCA170	LCA120	LCA125	LCA126	LCA127	LCA710	LCB110	LCB120	LCB126	LCB127	Units
Package Type	6 Pin DIP	6 Pin DIP	6 Pin DIP	6 Pin DIP	6 Pin DIP	6 Pin DIP	6 Pin DIP	6 Pin DIP	6 Pin DIP	6 Pin DIP	6 Pin DIP	6 Pin DIP	-
Contact Form	1-Form-A	1-Form-A	1-Form-A	1-Form-A	1-Form-A	1-Form-A	1-Form-A	1-Form-A	1-Form-B	1-Form-B	1-Form-B	1-Form-B	-
Load Voltage (Peak)	350	350	350	250	300	250	250	60	350	250	250	250	V
Load Current (Continuous)	120	120	100	170	170	170	200	1000	120	170	170	200	mA
On-Resistance @ Rated Load Current	25	35	50	20	16	15	10	0.5	35	20	15	10	Ω
Input Control Current (I _c)	5	2	5	5	5	5	5	10	5	5	5	5	mA

Part Number	OMA160	PLA110	PLA140	PLA160	Units
Package Type	6 Pin DIP	6 Pin DIP	6 Pin DIP	6 Pin DIP	-
Contact Form	1-Form-B	1-Form-A	1-Form-A	1-Form-A	-
Load Voltage (Peak)	250	400	400	300	V
Load Current (Continuous)	50	150	250	50	mA
On-Resistance @ Rated Load Current	100	22	8	100	Ω
Input Control Current (I _c)	10	5	5	10	mA

ORDERING INFORMATION

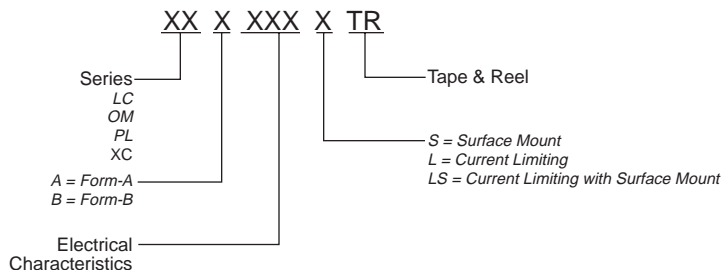

LCA100/LCA100L

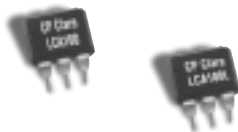

DESCRIPTION

LCA100 is a 350V, 120mA, 25Ω type 1-Form-A solid state relay. Current limiting version available. ("L" suffix).

FEATURES

- Small 6 Pin DIP Package
- Low Drive Power Requirements (TTL/CMOS Compatible)
- No Moving Parts
- High Reliability
- Arc-Free With No Snubbing Circuits
- 3750V_{RMS} Input/Output Isolation
- FCC Compatible
- VDE Compatible
- No EMI/RFI Generation
- Machine Insertable, Wave Solderable
- Current Limiting, Surface Mount and Tape & Reel Versions Available

APPROVALS

- UL Recognized: File Number E76270
- CSA Certified: File Number LR 43639-10
- BSI Certified to:
 - BS EN 60950:1992 (BS7002:1992) Certificate #: 7344
 - BS EN 41003:1993 Certificate #: 7344

OPTIONS / SUFFIXES

- L: Current Limiting
- S: Surface Mount Package
- TR: Tape & Reel

Switching Characteristics of Normally Open (Form A) Devices

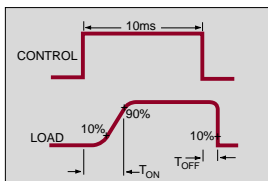

APPLICATIONS

- Telecommunications
 - Telecom Switching
 - Tip/Ring Circuits
 - Modem Switching (Laptop, Notebook, Pocket Size)
 - Hookswitch
 - Dial Pulsing
 - Ground Start
 - Ringer Injection
- Instrumentation
 - Multiplexers
 - Data Acquisition
 - Electronic Switching
 - I/O Subsystems
 - Meters (Watt-Hour, Water, Gas)
- Medical Equipment—Patient/Equipment Isolation
- Security
- Aerospace
- Industrial Controls

RATINGS (@ 25°C)

Parameter	Min	Typ	Max	Units
Input Power Dissipation	-	-	150 ¹	mW
Input Control Current	-	-	50	mA
Peak (10ms)	-	-	1	A
Reverse Input Voltage	-	-	5	V
Total Power Dissipation	-	-	800 ²	mW
Capacitance				
Input to Output	-	3	-	pF
Isolation Voltage				
Input to Output	3750	-	-	V _{RMS}
Operational Temperature	-40	-	+85	°C
Storage Temperature	-40	-	+125	°C
Soldering Temperature				
(10 Seconds Max.)				
DIP Package	-	-	+260	°C
Surface Mount Package	-	-	+220	°C

¹ Derate Linearly 1.33 mw/°C

² Derate Linearly 1.67 mw/°C

Note: For Mechanical Dimensions See Pages 396-401

SPECIFICATIONS

PARAMETERS	CONDITIONS	SYMBOL	LCA100			LCA100L			UNITS
			MIN	TYP	MAX	MIN	TYP	MAX	
Output Characteristics @ 25°C									
Load Voltage (Peak)	-	V_L	-	-	350	-	-	350	V
Load Current (Continuous)	-	I_L	-	-	120	-	-	120	mA
AC/DC Configuration	-	I_L	-	-	120	-	-	120	mA
DC Configuration	-	I_L	-	-	200	-	-	200	mA
Peak Load Current	10ms	I_{LPK}	-	-	350	-	-	-	mA
On-Resistance	-	R_{ON}	-	-	25	-	-	25	Ω
AC/DC Configuration	$I_L=120mA$	R_{ON}	-	-	25	-	-	25	Ω
DC Configuration	$I_L=200mA$	R_{ON}	-	-	8	-	-	8	Ω
Off-State Leakage Current	$V_L=350V$	I_{LEAK}	-	-	1	-	-	1	μA
Switching Speeds	-	-	-	-	-	-	-	-	-
Turn-On	$I_F=5mA, V_L=10V$	T_{ON}	-	-	5	-	-	5	ms
Turn-Off	$I_F=5mA, V_L=10V$	T_{OFF}	-	-	5	-	-	5	ms
Output Capacitance	50V; f=1MHz	C_{OUT}	-	35	-	-	35	-	pF
Load Current Limiting	-	I_{CL}	-	-	-	130	170	210	mA
Input Characteristics @ 25°C									
Input Control Current	$I_L=120mA$	I_F	5	-	50	5	-	50	mA
Input Dropout Current	-	I_F	0.4	0.7	-	0.4	0.7	-	mA
Input Voltage Drop	$I_F=5mA$	V_F	0.9	1.2	1.4	0.9	1.2	1.4	V
Reverse Input Voltage	-	V_R	-	-	5	-	-	5	V
Reverse Input Current	$V_R=5V$	I_R	-	-	10	-	-	10	μA
Input to Output Capacitance	-	$C_{I/O}$	-	3	-	-	3	-	pF
Input to Output Isolation	-	$V_{I/O}$	3750	-	-	3750	-	-	V_{RMS}

LCA100/LCA100L Pinout

AC/DC Configuration

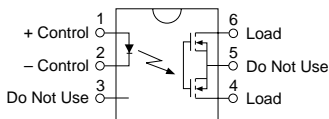

LCA100/LCA100L Pinout

DC Only Configuration

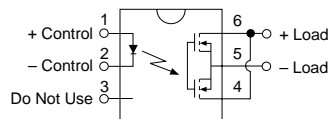

Note: For Mechanical Dimensions See Pages 396-401

PERFORMANCE DATA

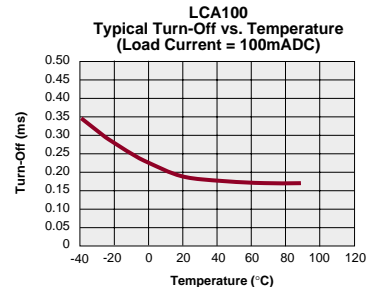
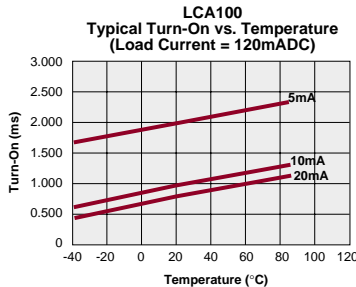
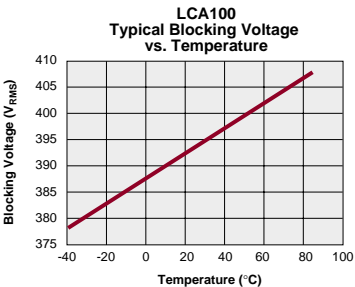
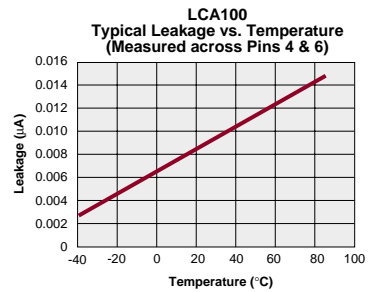
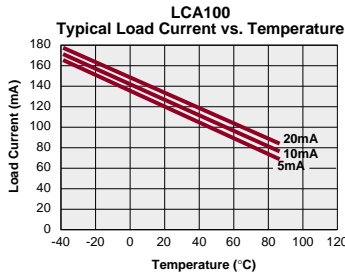
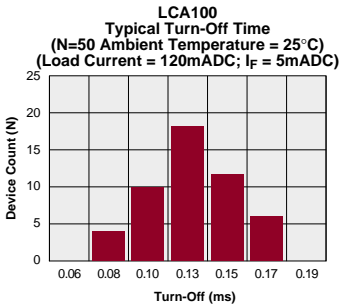
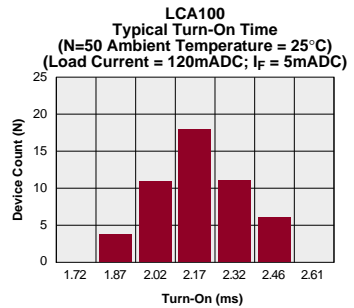
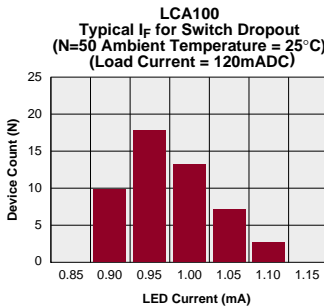
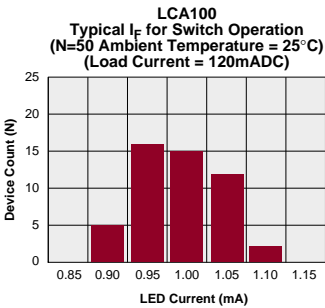
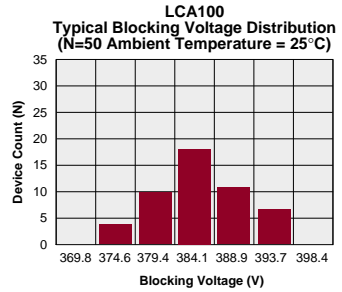
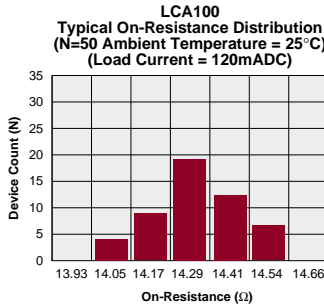
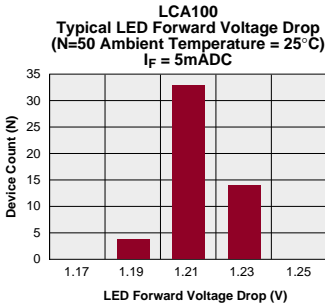

PERFORMANCE DATA

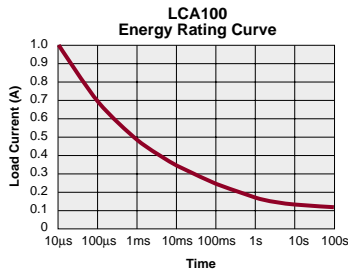
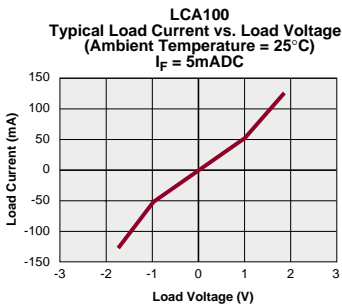
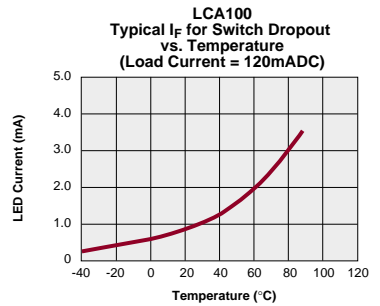
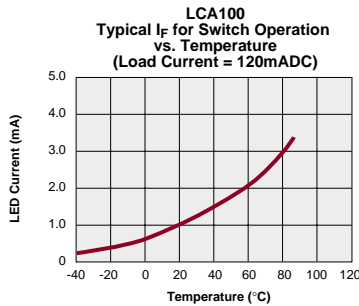
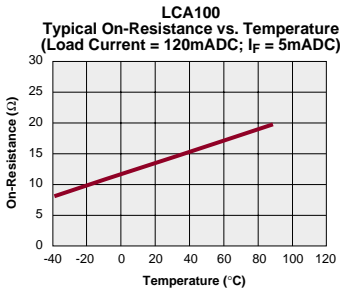
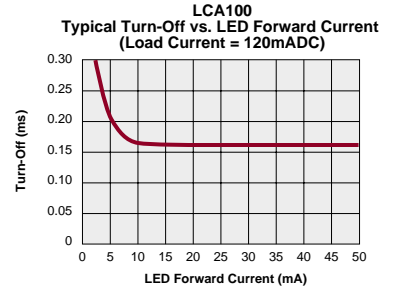
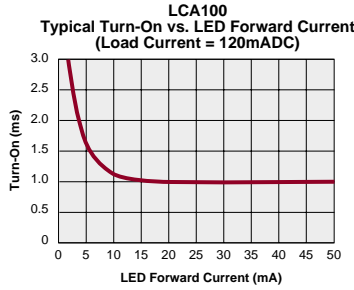
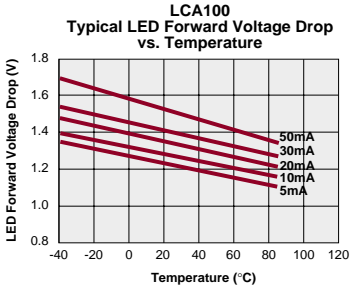

PERFORMANCE DATA

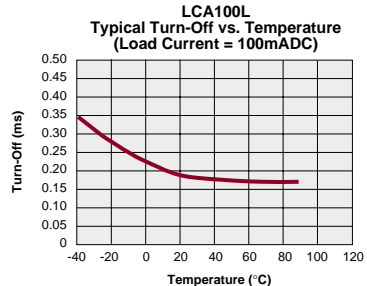
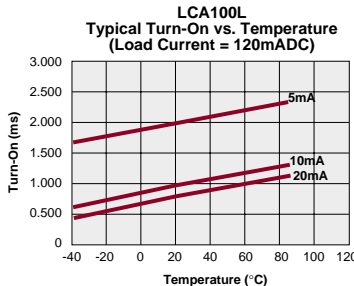
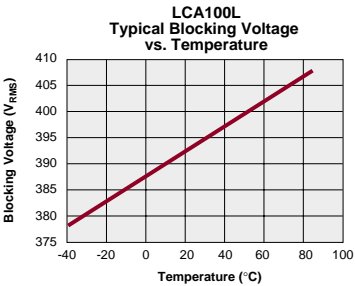
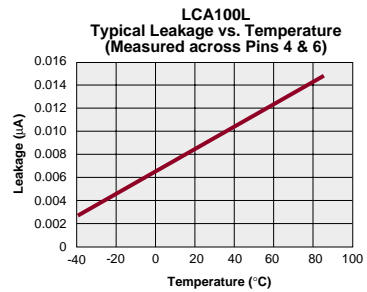
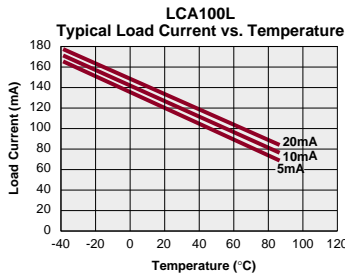
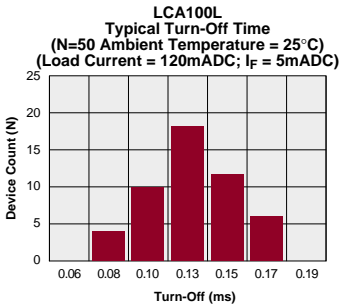
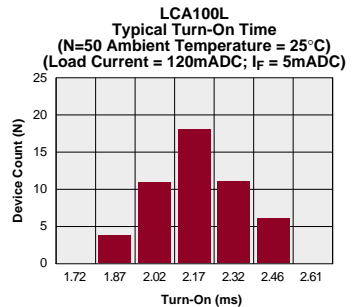
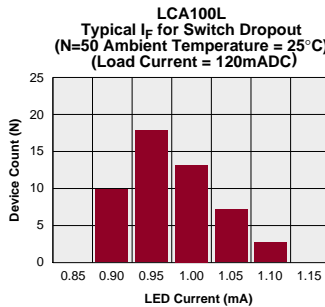
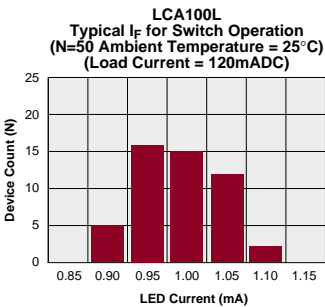
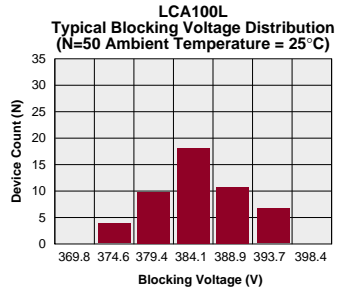
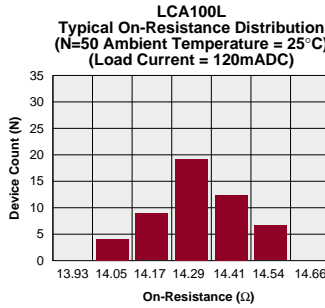
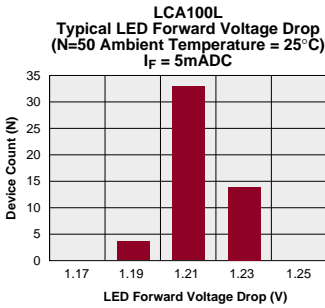

PERFORMANCE DATA

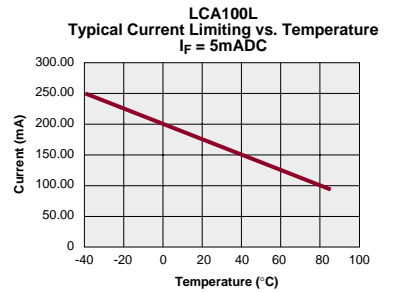
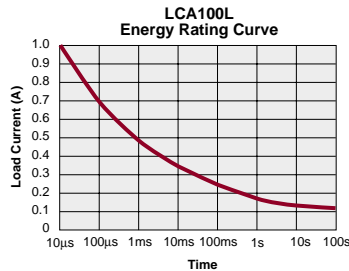
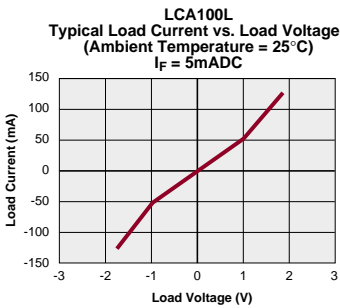
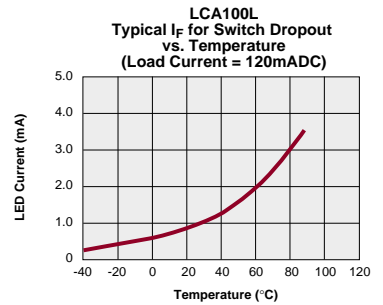
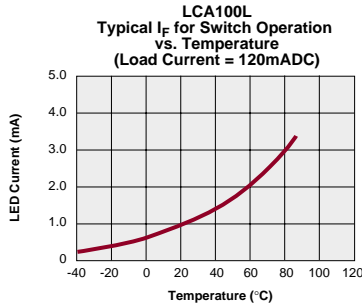
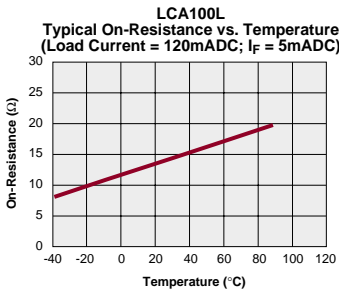
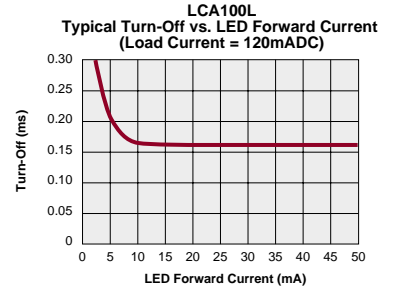
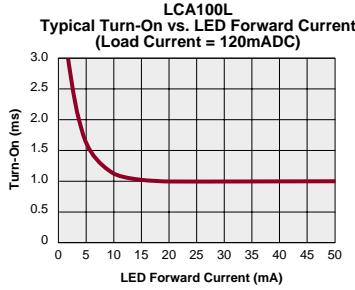
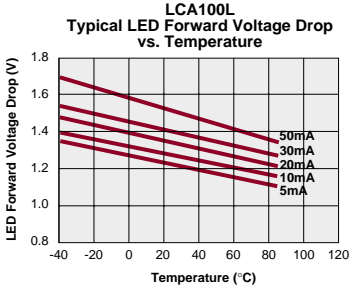

LCA110/LCA110L



DESCRIPTION

LCA110 is a 350V, 120mA, 35Ω type 1-Form-A solid state relay. Current limiting version available. ("L" suffix).

FEATURES

- Small 6 Pin DIP Package
- Low Drive Power Requirements (TTL/CMOS Compatible)
- No Moving Parts
- High Reliability
- Arc-Free With No Snubbing Circuits
- 3750V_{RMS} Input/Output Isolation
- FCC Compatible
- VDE Compatible
- No EMI/RFI Generation
- Machine Insertable, Wave Solderable
- Current Limiting, Surface Mount and Tape & Reel Versions Available

APPROVALS

- UL Recognized: File Number E76270
- CSA Certified: File Number LR 43639-10
- BSI Certified to:
 - BS EN 60950:1992 (BS7002:1992) Certificate #: 7344
 - BS EN 41003:1993 Certificate #: 7344

OPTIONS / SUFFIXES

- L: Current Limiting
- S: Surface Mount Package
- TR: Tape & Reel

Switching Characteristics of Normally Open (Form A) Devices

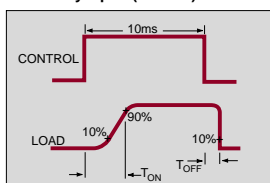

APPLICATIONS

- Telecommunications
 - Telecom Switching
 - Tip/Ring Circuits
 - Modem Switching (Laptop, Notebook, Pocket Size)
 - Hookswitch
 - Dial Pulsing
 - Ground Start
 - Ringer Injection
- Instrumentation
 - Multiplexers
 - Data Acquisition
 - Electronic Switching
 - I/O Subsystems
 - Meters (Watt-Hour, Water, Gas)
- Medical Equipment—Patient/Equipment Isolation
- Security
- Aerospace
- Industrial Controls

RATINGS (@ 25°C)

Parameter	Min	Typ	Max	Units
Input Power Dissipation	-	-	150 ¹	mW
Input Control Current	-	-	50	mA
Peak (10ms)	-	-	1	A
Reverse Input Voltage	-	-	5	V
Total Power Dissipation	-	-	800 ²	mW
Capacitance				
Input to Output	-	3	-	pF
Isolation Voltage				
Input to Output	3750	-	-	V _{RMS}
Operational Temperature	-40	-	+85	°C
Storage Temperature	-40	-	+125	°C
Soldering Temperature (10 Seconds Max.)				
DIP Package	-	-	+260	°C
Surface Mount Package	-	-	+220	°C

¹ Derate Linearly 1.33 mw/°C

² Derate Linearly 1.67 mw/°C

Note: For Mechanical Dimensions See Pages 396-401

SPECIFICATIONS

PARAMETERS	CONDITIONS	SYMBOL	LCA110			LCA110L			UNITS
			MIN	TYP	MAX	MIN	TYP	MAX	
Output Characteristics @ 25°C									
Load Voltage (Peak)	-	V_L	-	-	350	-	-	350	V
Load Current (Continuous)									
AC/DC Configuration	-	I_L	-	-	120	-	-	120	mA
DC Configuration	-	I_L	-	-	200	-	-	200	mA
Peak Load Current	10ms	I_{LPK}	-	-	350	-	-	-	mA
On-Resistance									
AC/DC Configuration	$I_L=120mA$	R_{ON}	-	23	35	-	19	35	Ω
DC Configuration	$I_L=200mA$	R_{ON}	-	7	10	-	7	10	Ω
Off-State Leakage Current	$V_L=350V$	I_{LEAK}	-	-	1	-	-	1	μA
Switching Speeds									
Turn-On	$I_F=5mA, V_L=10V$	T_{ON}	-	-	3	-	-	3	ms
Turn-Off	$I_F=5mA, V_L=10V$	T_{OFF}	-	-	3	-	-	3	ms
Output Capacitance	50V; f=1MHz	C_{OUT}	-	25	-	-	25	-	pF
Load Current Limiting		I_{CL}	-	-	-	130	170	210	mA
Input Characteristics @ 25°C									
Input Control Current	$I_L=120mA$	I_F	2	-	50	2	-	50	mA
Input Dropout Current	-	I_F	0.4	0.7	-	0.4	0.7	-	mA
Input Voltage Drop	$I_F=5mA$	V_F	0.9	1.2	1.4	0.9	1.2	1.4	V
Reverse Input Voltage	-	V_R	-	-	5	-	-	5	V
Reverse Input Current	$V_R=5V$	I_R	-	-	10	-	-	10	μA
Input to Output Capacitance	-	$C_{I/O}$	-	3	-	-	3	-	pF
Input to Output Isolation	-	$V_{I/O}$	3750	-	-	3750	-	-	V_{RMS}

LCA110/LCA110L Pinout

AC/DC Configuration

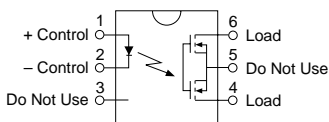

LCA110/LCA110L Pinout

DC Only Configuration

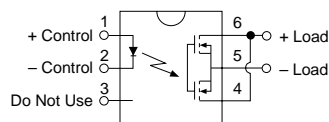

Note: For Mechanical Dimensions See Pages 396-401

LCA110/LCA110L

PERFORMANCE DATA

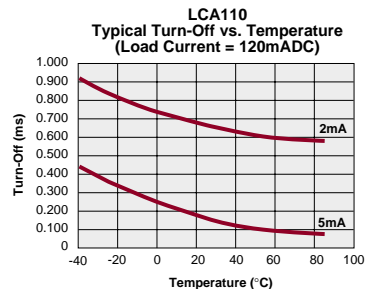
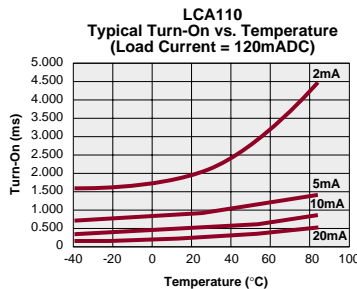
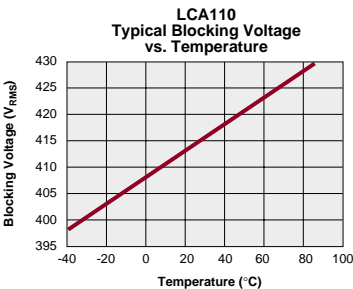
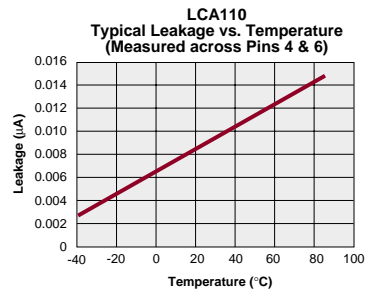
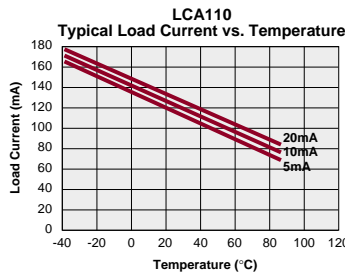
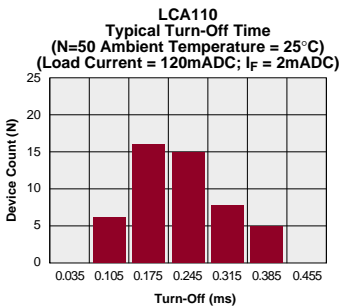
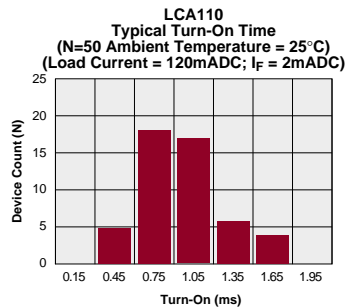
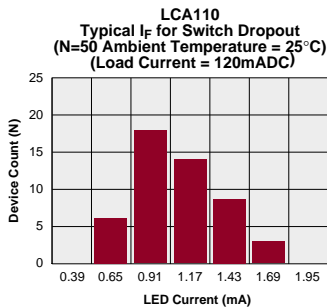
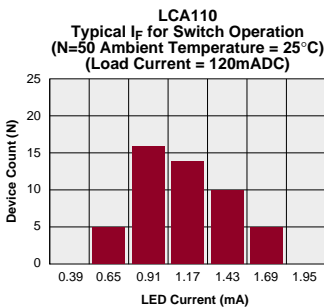
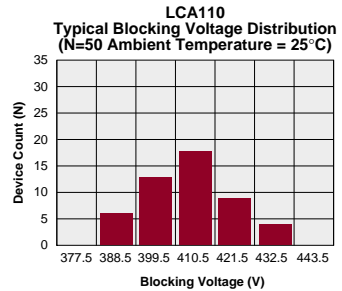
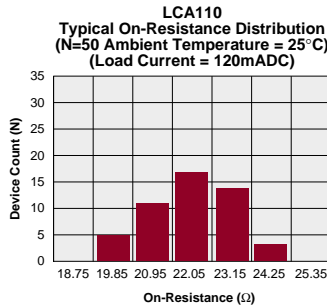
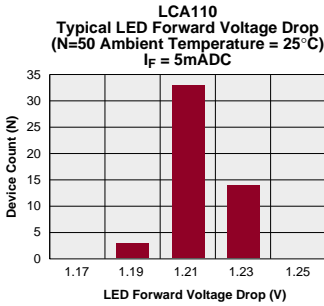

PERFORMANCE DATA

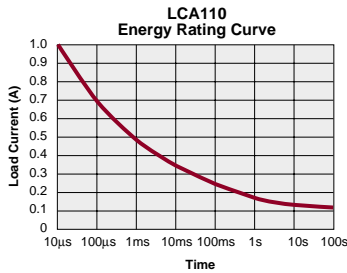
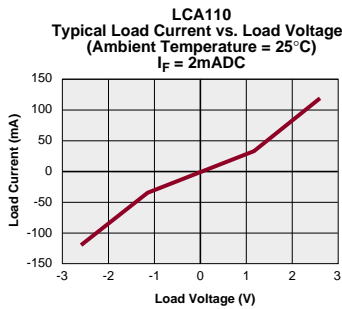
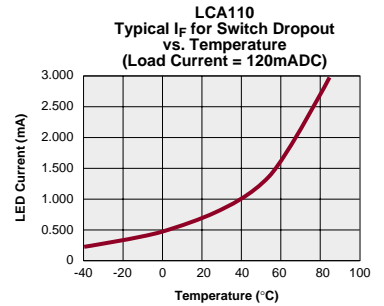
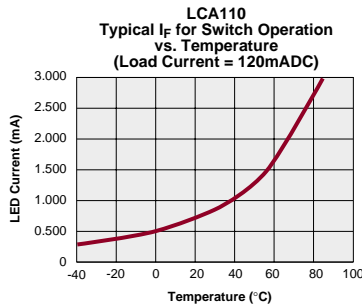
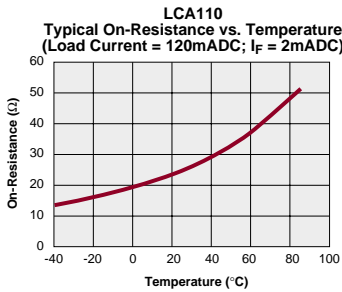
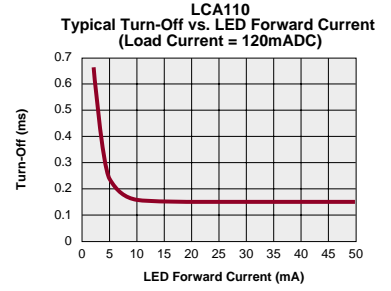
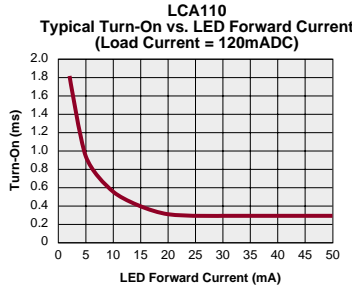
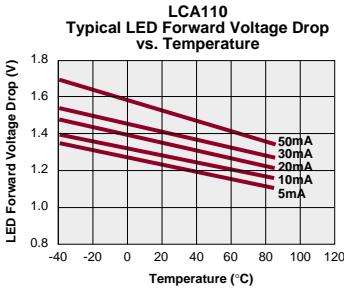

PERFORMANCE DATA

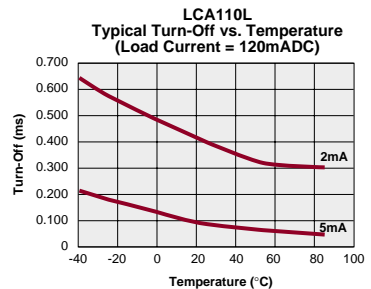
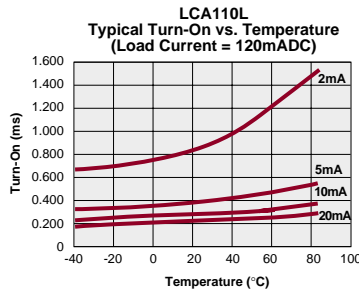
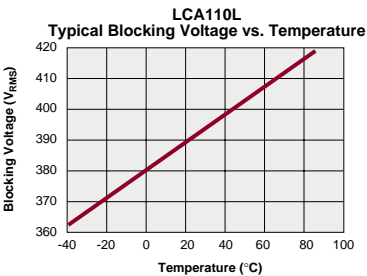
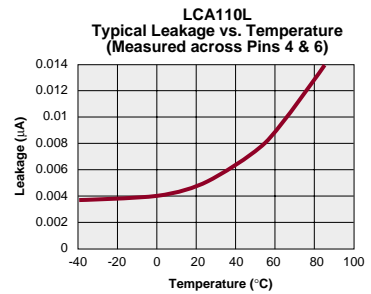
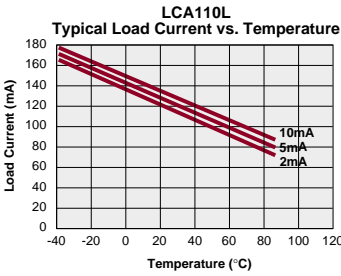
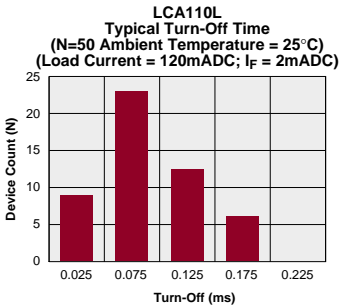
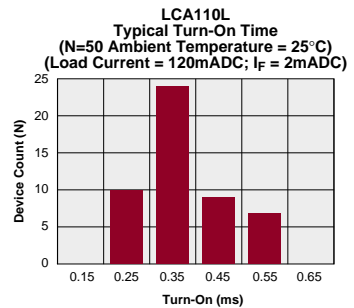
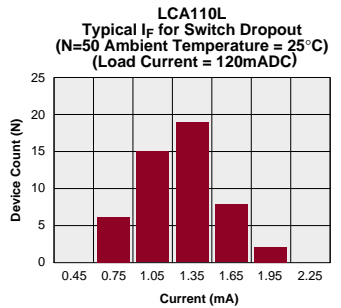
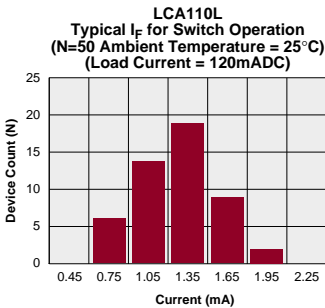
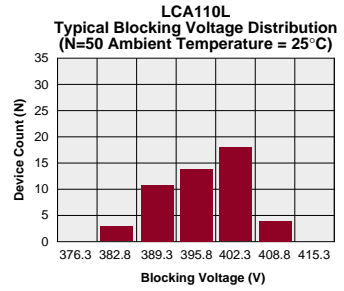
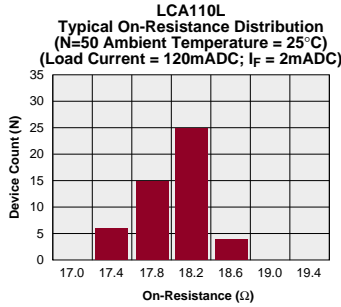
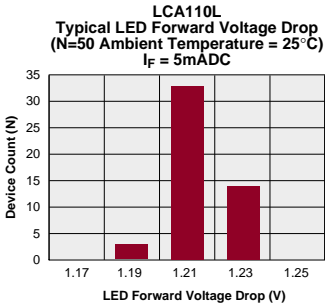

PERFORMANCE DATA

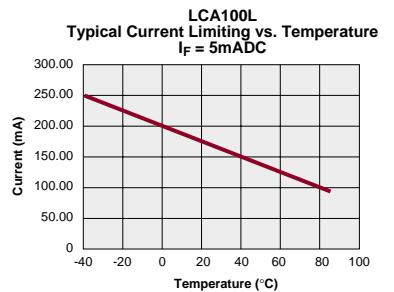
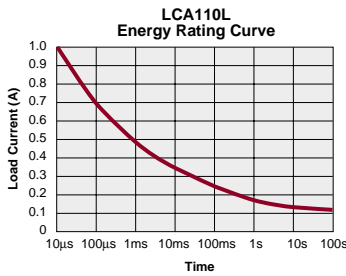
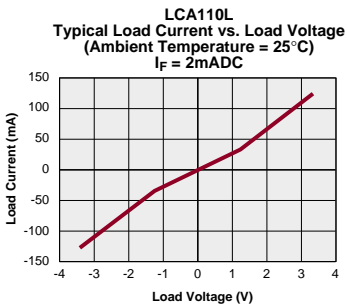
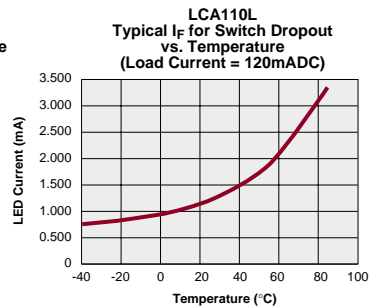
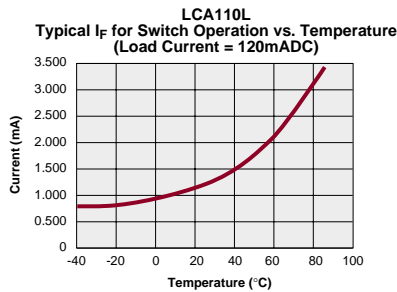
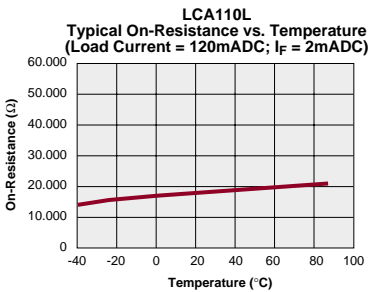
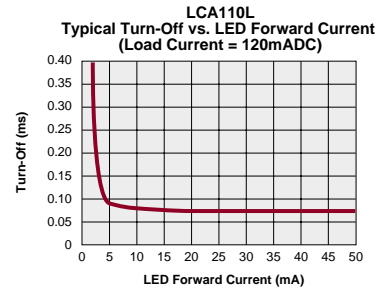
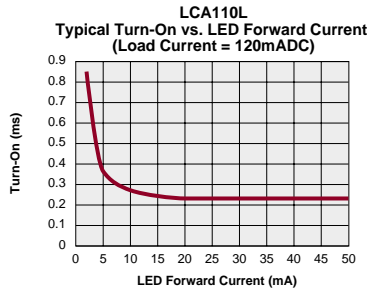
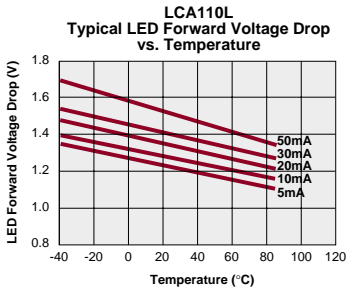

XCA170



DESCRIPTION

XCA170 is a 350V, 120mA, 50Ω type 1-Form-A solid state relay.

FEATURES

- Small 6 Pin DIP Package
- Low Drive Power Requirements (TTL/CMOS Compatible)
- No Moving Parts
- High Reliability
- Arc-Free With No Snubbing Circuits
- 3750V_{RMS} Input/Output Isolation
- FCC Compatible
- VDE Compatible
- No EMI/RFI Generation
- Machine Insertable, Wave Solderable
- Current Limiting, Surface Mount and Tape & Reel Versions Available

APPROVALS

- UL Recognized: File Number E76270
- CSA Certified: File Number LR 43639-10
- BSI Certified to:
 - BS EN 60950:1992 (BS7002:1992) Certificate #: 7344
 - BS EN 41003:1993 Certificate #: 7344

OPTIONS / SUFFIXES

- S: Surface Mount Package
- TR: Tape & Reel

Switching Characteristics of Normally Open (Form A) Devices

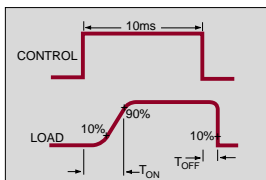

APPLICATIONS

- Telecommunications
 - Telecom Switching
 - Tip/Ring Circuits
 - Modem Switching (Laptop, Notebook, Pocket Size)
 - Hookswitch
 - Dial Pulsing
 - Ground Start
 - Ringer Injection
- Instrumentation
 - Multiplexers
 - Data Acquisition
 - Electronic Switching
 - I/O Subsystems
 - Meters (Watt-Hour, Water, Gas)
- Medical Equipment—Patient/Equipment Isolation
- Security
- Aerospace
- Industrial Controls

RATINGS (@ 25° C)

Parameter	Min	Typ	Max	Units
Input Power Dissipation	-	-	150 ¹	mW
Input Control Current	-	-	50	mA
Peak (10ms)	-	-	1	A
Reverse Input Voltage	-	-	5	V
Total Power Dissipation	-	-	800 ²	mW
Capacitance				
Input to Output	-	3	-	pF
Isolation Voltage				
Input to Output	3750	-	-	V _{RMS}
Operational Temperature	-40	-	+85	°C
Storage Temperature	-40	-	+125	°C
Soldering Temperature (10 Seconds Max.)				
DIP Package	-	-	+260	°C
Surface Mount Package	-	-	+220	°C

¹ Derate Linearly 1.33 mw/°C

² Derate Linearly 1.67 mw/°C

Note: For Mechanical Dimensions See Pages 396-401

SPECIFICATIONS

PARAMETERS	CONDITIONS	SYMBOL	MIN	TYP	MAX	UNITS
Output Characteristics @ 25°C						
Load Voltage (Peak)	-	V_L	-	-	350	V
Load Current (Continuous)	-	I_L	-	-	100	mA
AC/DC Configuration	-	I_L	-	-	180	mA
DC Configuration	-	I_L	-	-	180	mA
Peak Load Current	10ms	I_{LPK}	-	-	350	mA
On-Resistance	-	R_{ON}	-	-	-	Ω
AC/DC Configuration	$I_L=120mA$	R_{ON}	-	31	50	Ω
DC Configuration	$I_L=200mA$	R_{ON}	-	10	15	Ω
Off-State Leakage Current	$V_L=350V$	I_{LEAK}	-	-	1	μA
Switching Speeds	-	T_{ON}	-	-	-	ms
Turn-On	$I_F=5mA, V_L=10V$	T_{ON}	-	-	5	ms
Turn-Off	$I_F=5mA, V_L=10V$	T_{OFF}	-	-	5	ms
Output Capacitance	50V; f=1MHz	C_{OUT}	-	25	-	pF
Load Current Limiting	-	I_{CL}	-	-	-	mA
Input Characteristics @ 25°C						
Input Control Current	$I_L=120mA$	I_F	5	-	50	mA
Input Dropout Current	-	I_F	0.4	0.7	-	mA
Input Voltage Drop	$I_F=5mA$	V_F	0.9	1.2	1.4	V
Reverse Input Voltage	-	V_R	-	-	5	V
Reverse Input Current	$V_R=5V$	I_R	-	-	10	μA
Input to Output Capacitance	-	$C_{I/O}$	-	3	-	pF
Input to Output Isolation	-	$V_{I/O}$	3750	-	-	V_{RMS}

XCA170 Pinout

AC/DC Configuration

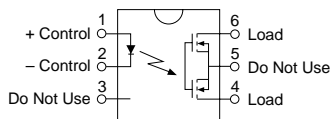

XCA170 Pinout

DC Only Configuration

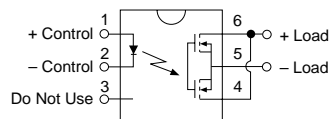

Note: For Mechanical Dimensions See Pages 396-401

XCA170

PERFORMANCE DATA

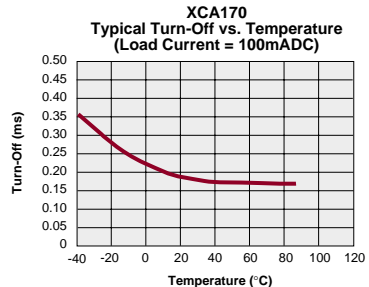
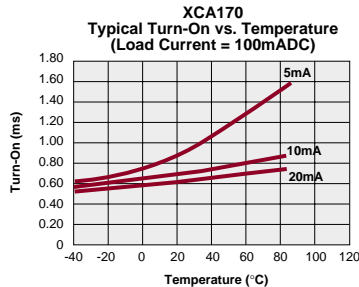
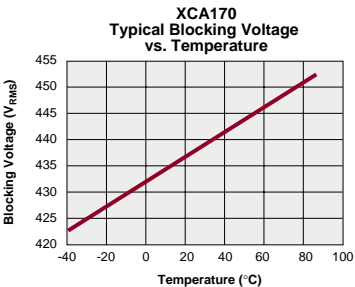
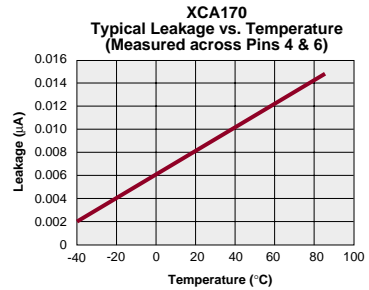
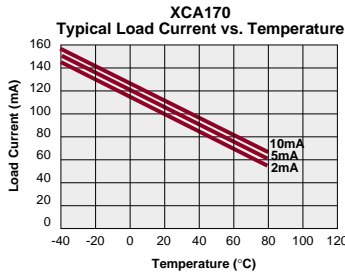
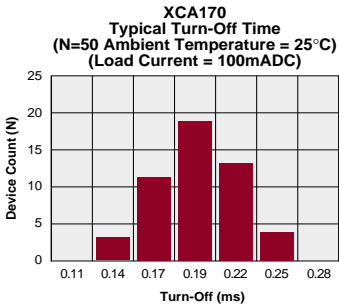
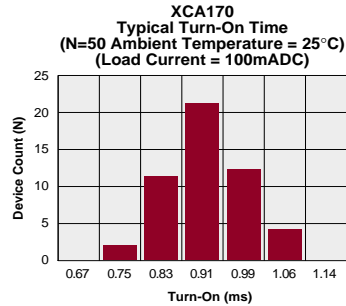
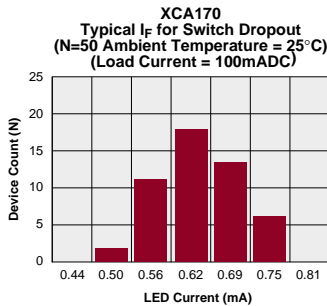
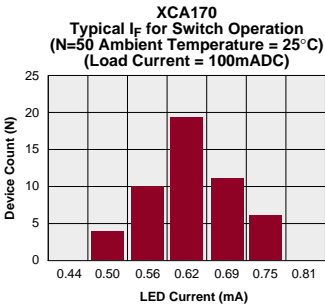
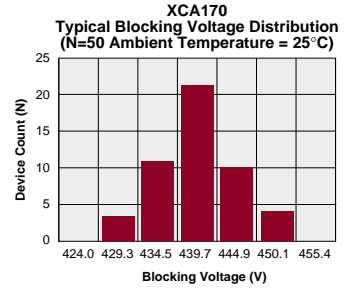
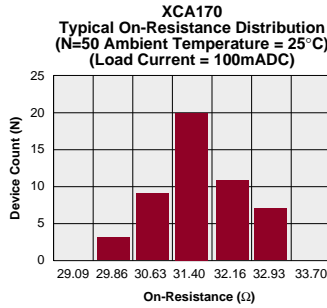
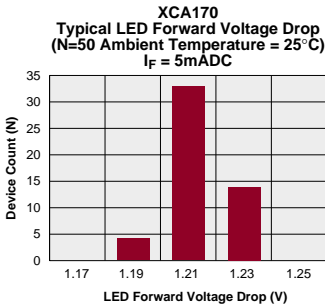

PERFORMANCE DATA

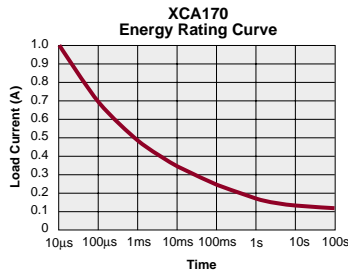
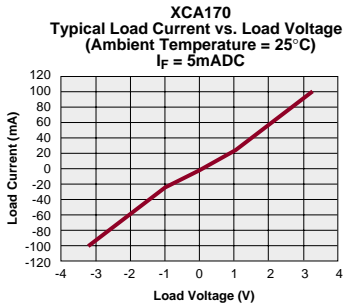
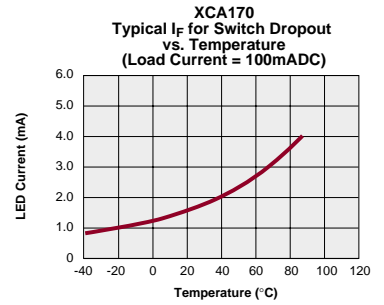
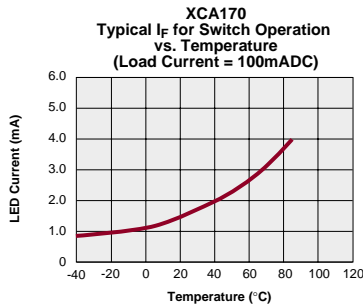
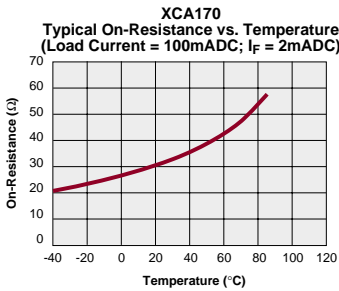
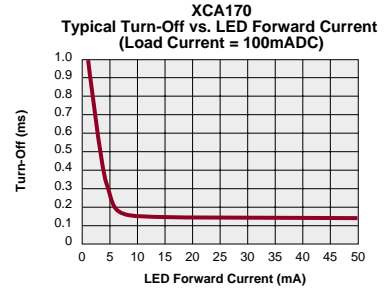
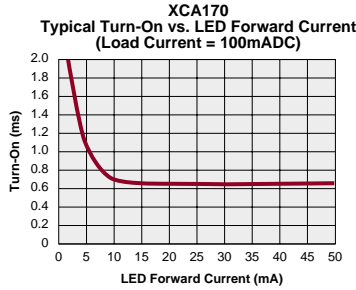
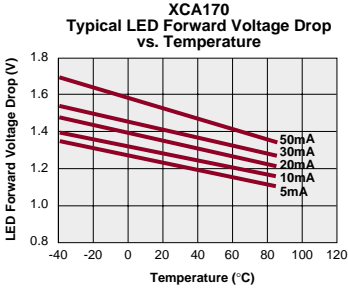

LCA120/LCA120L



DESCRIPTION

The LCA120 is a 250V, 170mA, 20Ω type 1-Form-A solid state relay. Current limiting version available. ("L" suffix).

FEATURES

- Small 6 Pin DIP Package
- Low Drive Power Requirements (TTL/CMOS Compatible)
- No Moving Parts
- High Reliability
- Arc-Free With No Snubbing Circuits
- 3750V_{RMS} Input/Output Isolation
- FCC Compatible
- VDE Compatible
- No EMI/RFI Generation
- Machine Insertable, Wave Solderable
- Current Limiting, Surface Mount and Tape & Reel Versions Available

APPROVALS

- UL Recognized: File Number E76270
- CSA Certified: File Number LR 43639-10
- BSI Certified to:
 - BS EN 60950:1992 (BS7002:1992) Certificate #: 7344
 - BS EN 41003:1993 Certificate #: 7344

OPTIONS / SUFFIXES

- L: Current Limiting
- S: Surface Mount Package
- TR: Tape & Reel

Switching Characteristics of Normally Open (Form A) Devices

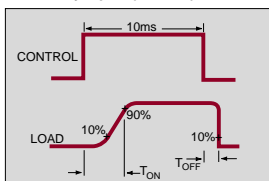

APPLICATIONS

- Telecommunications
 - Telecom Switching
 - Tip/Ring Circuits
 - Modem Switching (Laptop, Notebook, Pocket Size)
 - Hookswitch
 - Dial Pulsing
 - Ground Start
 - Ringer Injection
- Instrumentation
 - Multiplexers
 - Data Acquisition
 - Electronic Switching
 - I/O Subsystems
 - Meters (Watt-Hour, Water, Gas)
- Medical Equipment—Patient/Equipment Isolation
- Security
- Aerospace
- Industrial Controls

RATINGS (@ 25° C)

Parameter	Min	Typ	Max	Units
Input Power Dissipation	-	-	150 ¹	mW
Input Control Current	-	-	50	mA
Peak (10ms)	-	-	1	A
Reverse Input Voltage	-	-	5	V
Total Power Dissipation	-	-	800 ²	mW
Capacitance				
Input to Output	-	3	-	pF
Isolation Voltage				
Input to Output	3750	-	-	V _{RMS}
Operational Temperature	-40	-	+85	°C
Storage Temperature	-40	-	+125	°C
Soldering Temperature (10 Seconds Max.)				
DIP Package	-	-	+260	°C
Surface Mount Package	-	-	+220	°C

¹ Derate Linearly 1.33 mw/°C

² Derate Linearly 1.67 mw/°C

Note: For Mechanical Dimensions See Pages 396-401

SPECIFICATIONS

PARAMETERS	CONDITIONS	SYMBOL	LCA120			LCA120L			UNITS
			MIN	TYP	MAX	MIN	TYP	MAX	
Output Characteristics @ 25°C									
Load Voltage (Peak)	-	V_L	-	-	250	-	-	250	V
Load Current (Continuous)	-	I_L	-	-	170	-	-	150	mA
AC/DC Configuration	-	I_L	-	-	300	-	-	200	mA
DC Configuration	-	I_L	-	-	400	-	-	-	mA
Peak Load Current	10ms	I_{LPK}	-	-	400	-	-	-	mA
On-Resistance	-	R_{ON}	-	-	-	-	-	-	Ω
AC/DC Configuration	I_L =Load Current	R_{ON}	-	12	20	-	15	20	Ω
DC Configuration	I_L =Load Current	R_{ON}	-	4	6	-	5	6	Ω
Off-State Leakage Current	V_L =250V	I_{LEAK}	-	-	1	-	-	1	μ A
Switching Speeds	-	-	-	-	-	-	-	-	-
Turn-On	I_F =5mA, V_L =10V	T_{ON}	-	-	5	-	-	3	ms
Turn-Off	I_F =5mA, V_L =10V	T_{OFF}	-	-	5	-	-	3	ms
Output Capacitance	50V; f=1MHz	C_{OUT}	-	50	-	-	50	-	pF
Load Current Limiting	-	I_{CL}	-	-	-	190	235	280	mA
Input Characteristics @ 25°C									
Input Control Current	I_L =Load Current	I_F	5	-	50	5	-	50	mA
Input Dropout Current	-	I_F	0.4	0.7	-	0.4	0.7	-	mA
Input Voltage Drop	I_F =5mA	V_F	0.9	1.2	1.4	0.9	1.2	1.4	V
Reverse Input Voltage	-	V_R	-	-	5	-	-	5	V
Reverse Input Current	V_R =5V	I_R	-	-	10	-	-	10	μ A
Input to Output Capacitance	-	$C_{I/O}$	-	3	-	-	3	-	pF
Input to Output Isolation	-	$V_{I/O}$	3750	-	-	3750	-	-	V_{RMS}

LCA120/LCA120L Pinout

AC/DC Configuration

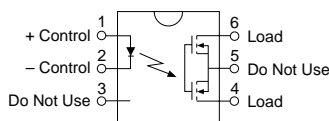

LCA120/LCA120L Pinout

DC Only Configuration

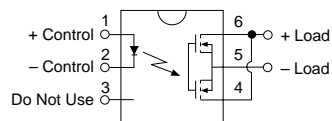

Note: For Mechanical Dimensions See Pages 396-401

PERFORMANCE DATA

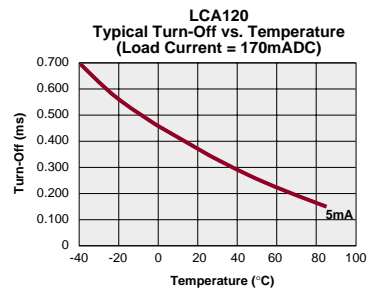
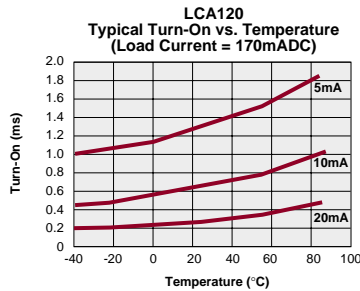
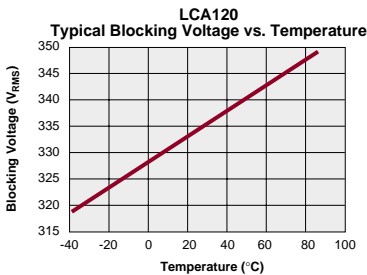
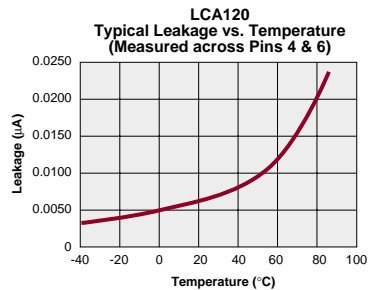
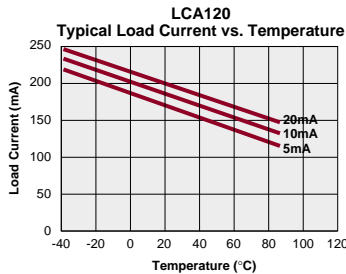
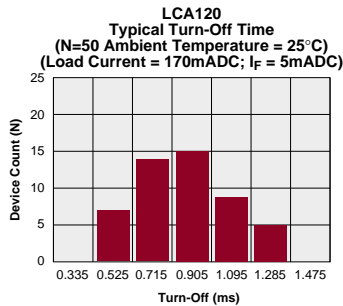
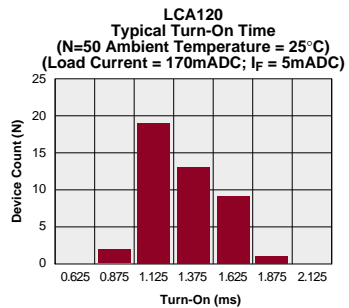
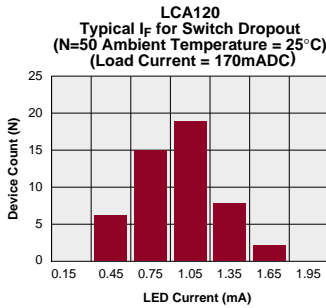
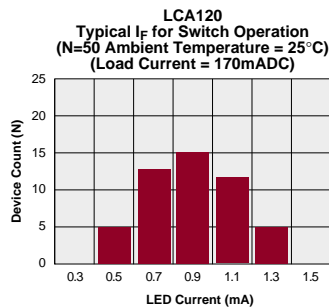
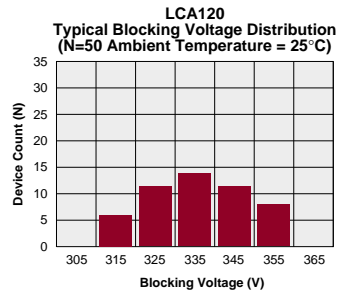
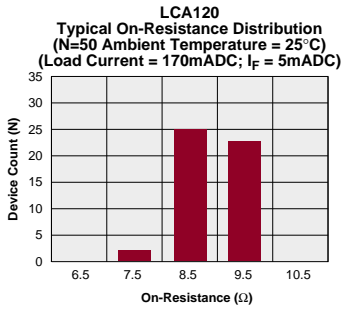
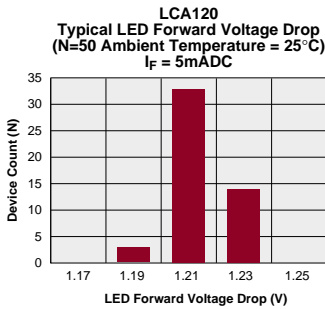

PERFORMANCE DATA

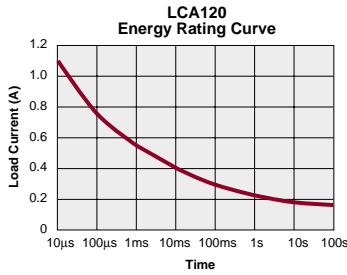
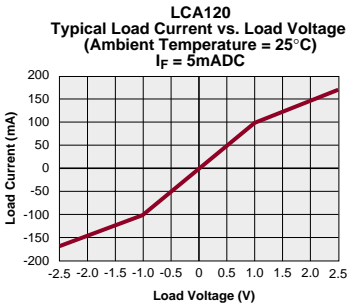
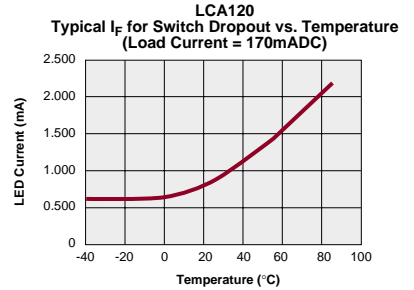
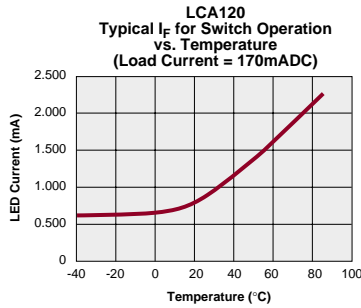
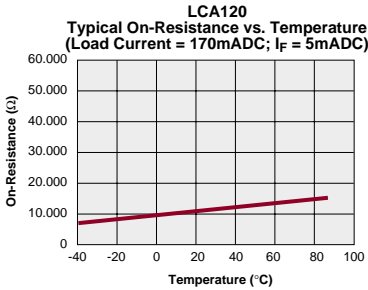
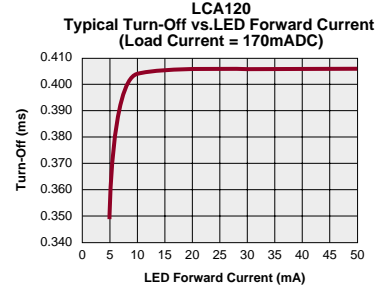
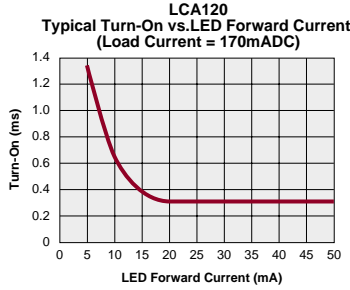
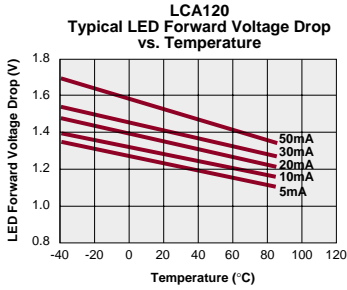

LCA120/LCA120L

PERFORMANCE DATA

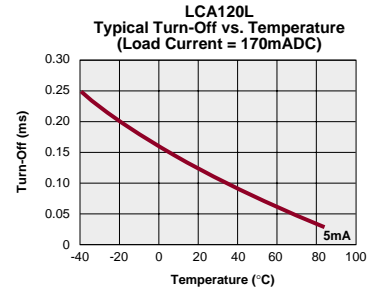
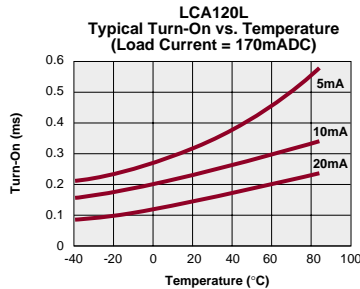
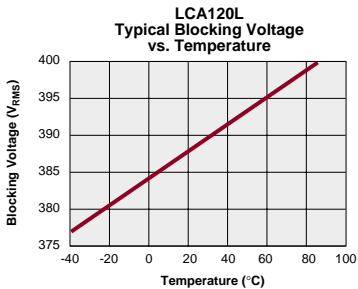
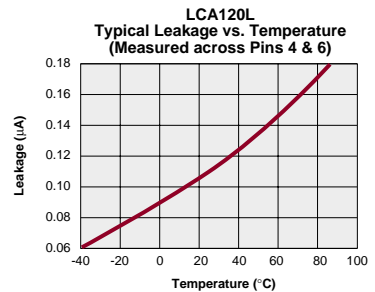
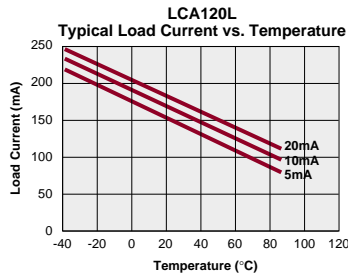
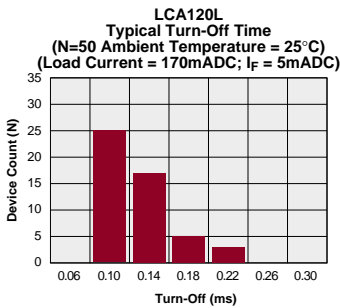
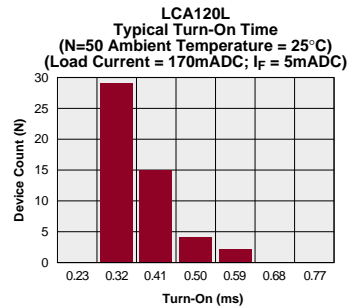
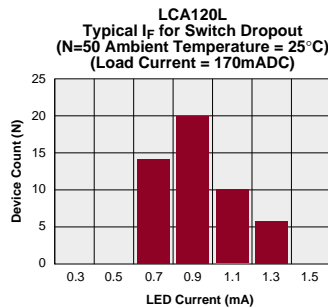
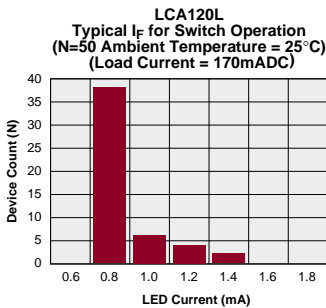
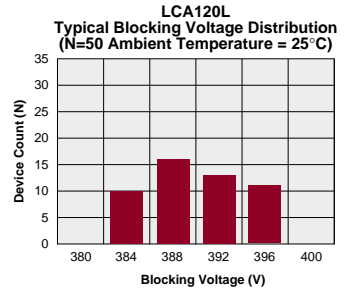
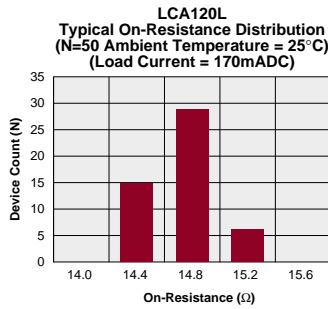
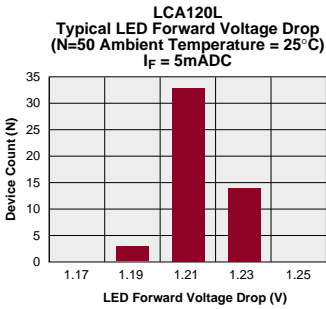

PERFORMANCE DATA

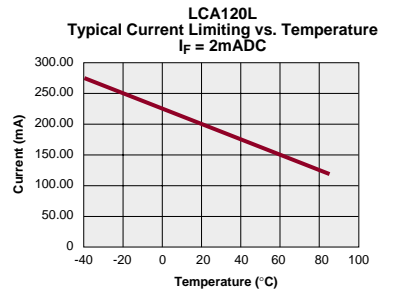
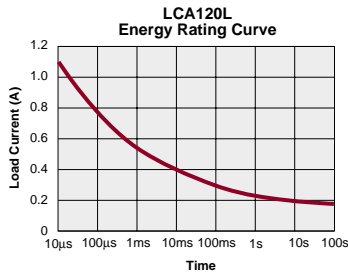
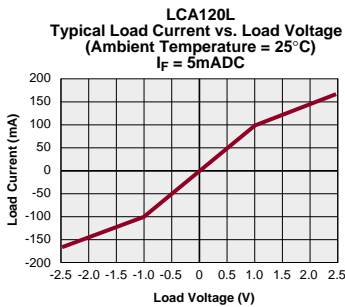
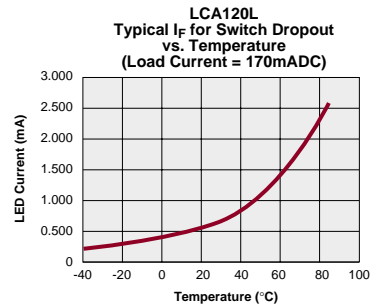
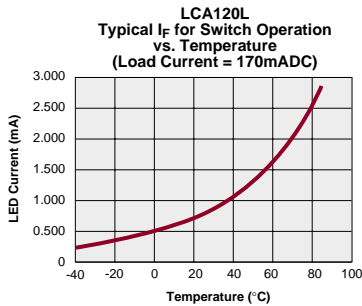
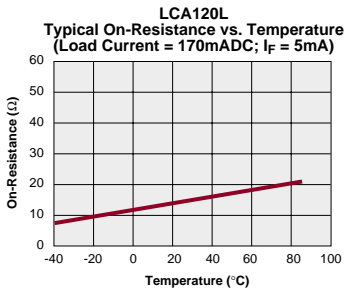
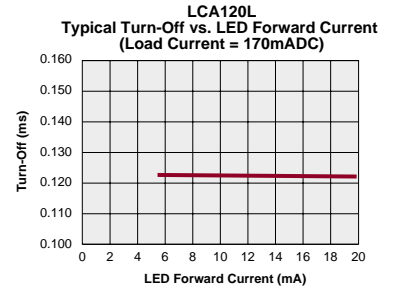
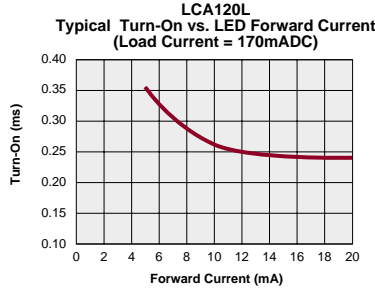
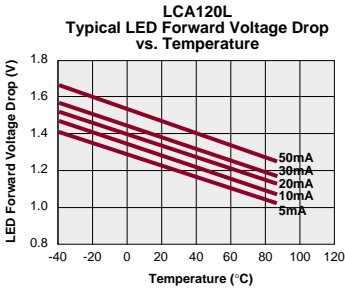

LCA125/LCA125L



DESCRIPTION

The LCA125 is a 300V, 170mA, 16Ω type 1-Form-A solid state relay. Current limiting version available. ("L" suffix).

FEATURES

- Small 6 Pin DIP Package
- Low Drive Power Requirements (TTL/CMOS Compatible)
- No Moving Parts
- High Reliability
- Arc-Free With No Snubbing Circuits
- 3750V_{RMS} Input/Output Isolation
- FCC Compatible
- VDE Compatible
- No EMI/RFI Generation
- Machine Insertable, Wave Solderable
- Current Limiting, Surface Mount and Tape & Reel Versions Available

APPROVALS

- UL Recognized: File Number E76270
- CSA Certified: File Number LR 43639-10
- BSI Certified to:
 - BS EN 60950:1992 (BS7002:1992) Certificate #: 7344
 - BS EN 41003:1993 Certificate #: 7344

OPTIONS / SUFFIXES

- L: Current Limiting
- S: Surface Mount Package
- TR: Tape & Reel

Switching Characteristics of Normally Open (Form A) Devices

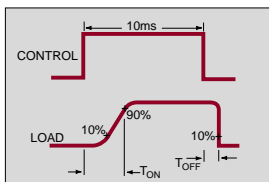

APPLICATIONS

- Telecommunications
 - Telecom Switching
 - Tip/Ring Circuits
 - Modem Switching (Laptop, Notebook, Pocket Size)
 - Hookswitch
 - Dial Pulsing
 - Ground Start
 - Ringer Injection
- Instrumentation
 - Multiplexers
 - Data Acquisition
 - Electronic Switching
 - I/O Subsystems
 - Meters (Watt-Hour, Water, Gas)
- Medical Equipment—Patient/Equipment Isolation
- Security
- Aerospace
- Industrial Controls

RATINGS (@ 25° C)

Parameter	Min	Typ	Max	Units
Input Power Dissipation	-	-	150 ¹	mW
Input Control Current	-	-	50	mA
Peak (10ms)	-	-	1	A
Reverse Input Voltage	-	-	5	V
Total Power Dissipation	-	-	800 ²	mW
Capacitance				
Input to Output	-	3	-	pF
Isolation Voltage				
Input to Output	3750	-	-	V _{RMS}
Operational Temperature	-40	-	+85	°C
Storage Temperature	-40	-	+125	°C
Soldering Temperature (10 Seconds Max.)				
DIP Package	-	-	+260	°C
Surface Mount Package	-	-	+220	°C

¹ Derate Linearly 1.33 mw/°C

² Derate Linearly 1.67 mw/°C

Note: For Mechanical Dimensions See Pages 396-401

SPECIFICATIONS

PARAMETERS	CONDITIONS	SYMBOL	LCA125			LCA125L			UNITS
			MIN	TYP	MAX	MIN	TYP	MAX	
Output Characteristics @ 25°C									
Load Voltage (Peak)	-	V_L	-	-	300	-	-	300	V
Load Current (Continuous)	-	I_L	-	-	170	-	-	170	mA
AC/DC Configuration	-	I_L	-	-	170	-	-	170	mA
DC Configuration	-	I_L	-	-	300	-	-	300	mA
Peak Load Current	10ms	I_L	-	-	400	-	-	-	mA
On-Resistance	-	R_{ON}	-	-	-	-	-	-	Ω
AC/DC Configuration	$I_L=170mA$	R_{ON}	-	10	16	-	12	20	Ω
DC Configuration	$I_L=300mA$	R_{ON}	-	4	5	-	4	6	Ω
Off-State Leakage Current	$V_L=300V$	I_{LEAK}	-	-	1	-	-	1	μA
Switching Speeds	-	-	-	-	-	-	-	-	-
Turn-On	$I_F=5mA, V_L=10V$	T_{ON}	-	-	5	-	-	5	ms
Turn-Off	$I_F=5mA, V_L=10V$	T_{OFF}	-	-	5	-	-	5	ms
Output Capacitance	50V; f=1MHz	C_{OUT}	-	50	-	-	50	-	pF
Load Current Limiting	-	I_{CL}	-	-	-	190	235	280	mA
Input Characteristics @ 25°C									
Input Control Current	$I_L=170mA$	I_F	5	-	50	5	-	50	mA
Input Dropout Current	-	-	0.4	0.7	-	0.4	0.7	-	mA
Input Voltage Drop	$I_F=5mA$	V_F	0.9	1.2	1.4	0.9	1.2	1.4	V
Reverse Input Voltage	-	V_R	-	-	5	-	-	5	V
Reverse Input Current	$V_R=5V$	I_R	-	-	10	-	-	10	μA
Input to Output Capacitance	-	$C_{I/O}$	-	3	-	-	3	-	pF
Input to Output Isolation	-	$V_{I/O}$	3750	-	-	3750	-	-	V_{RMS}

LCA125/LCA125L Pinout

AC/DC Configuration

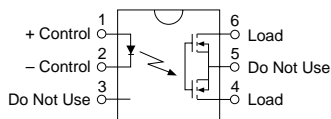

LCA125/125L Pinout

DC Only Configuration

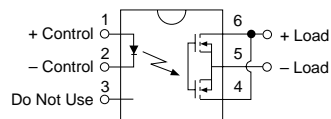

Note: For Mechanical Dimensions See Pages 396-401

LCA125/LCA125L

PERFORMANCE DATA

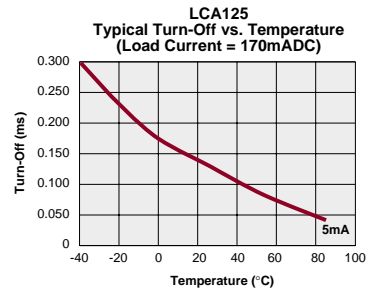
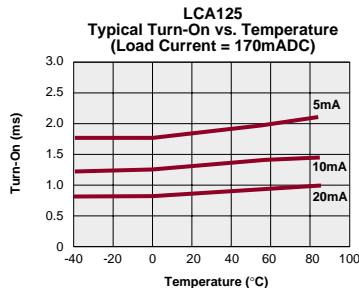
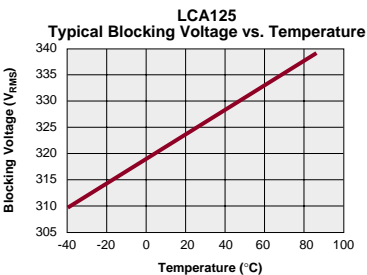
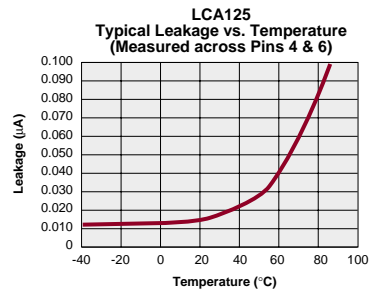
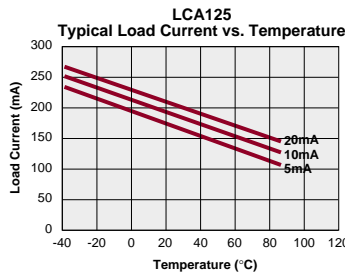
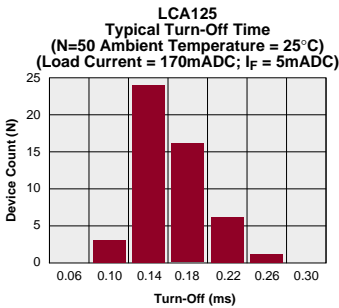
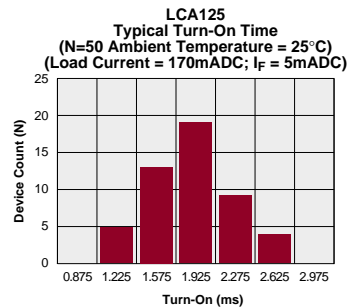
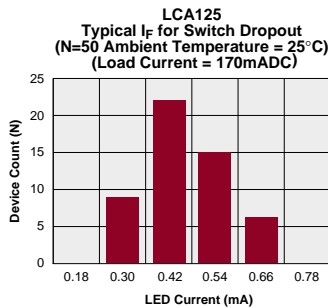
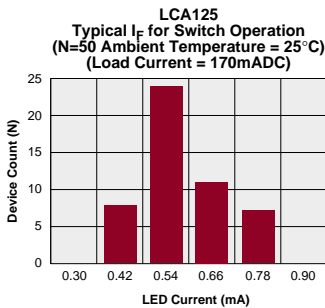
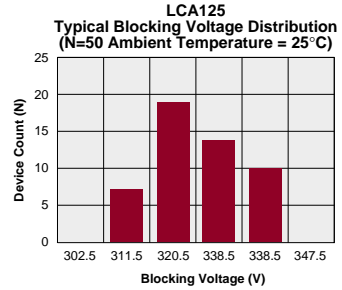
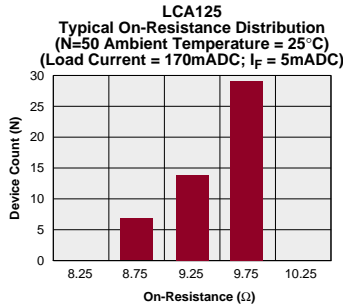
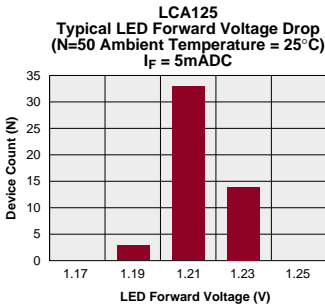

PERFORMANCE DATA

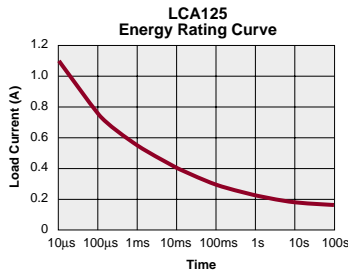
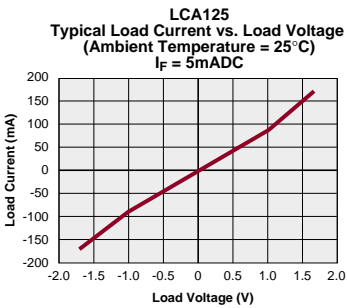
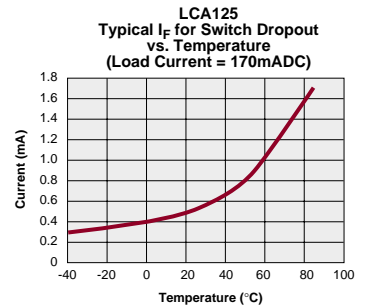
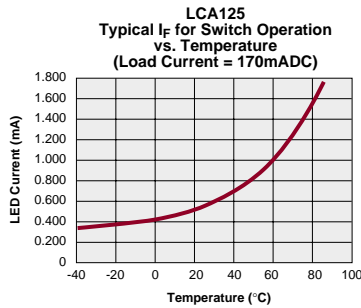
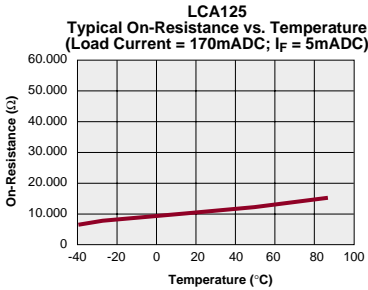
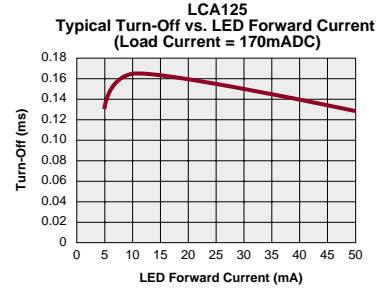
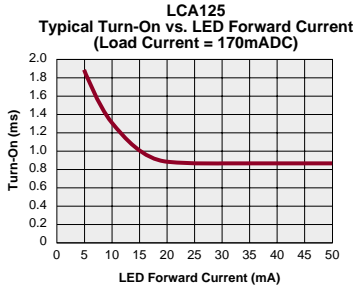
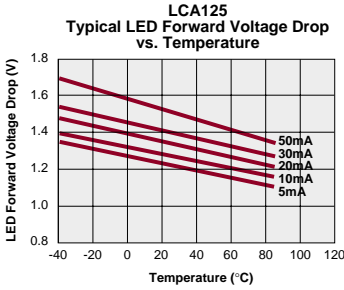

LCA125/LCA125L

PERFORMANCE DATA

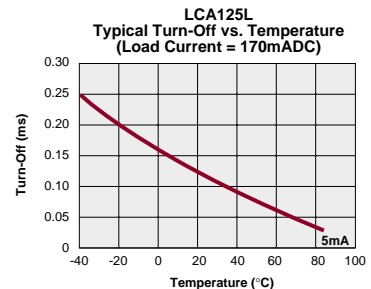
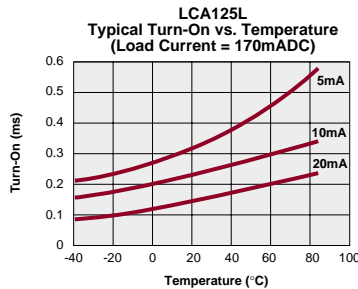
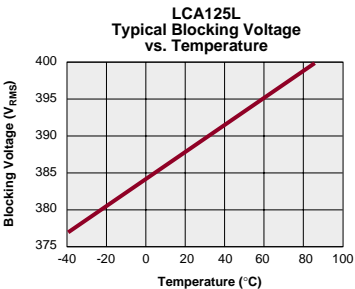
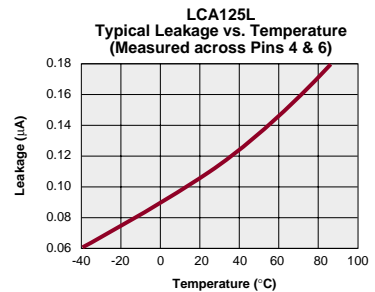
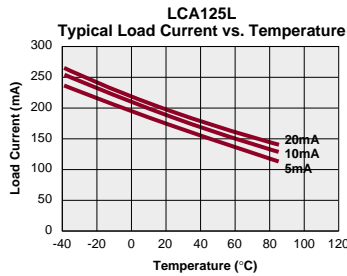
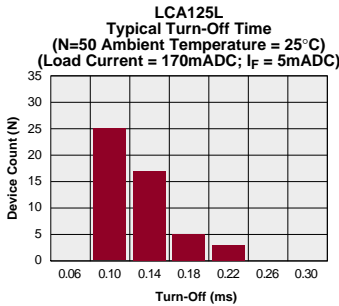
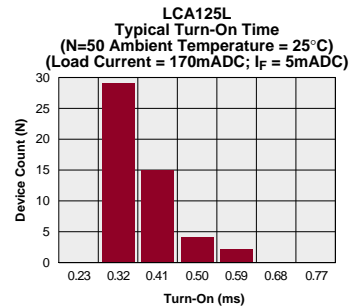
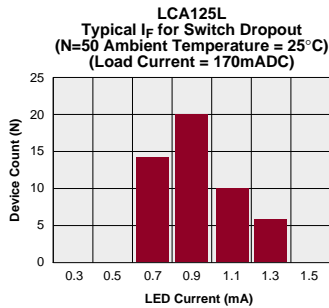
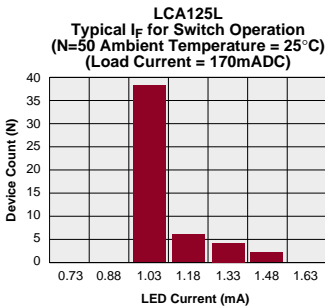
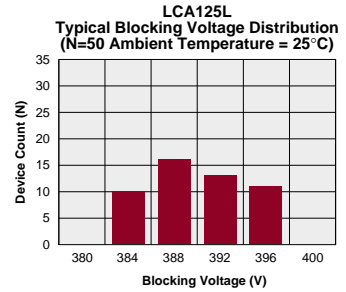
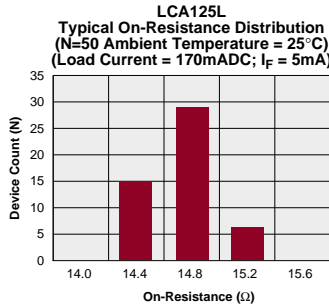
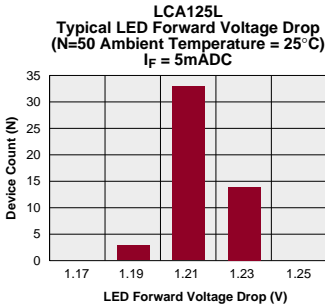

PERFORMANCE DATA

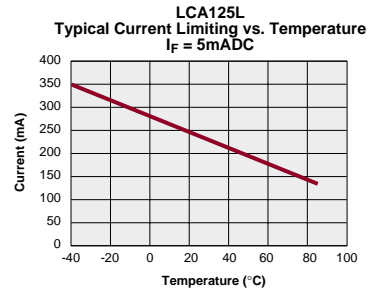
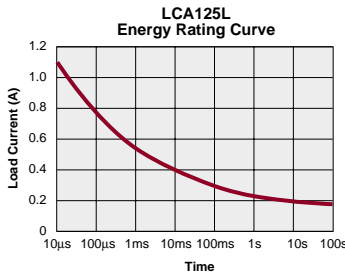
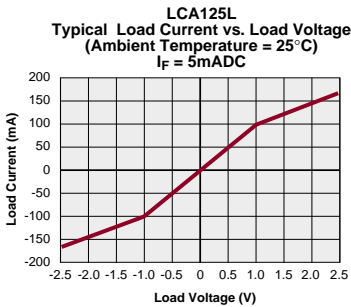
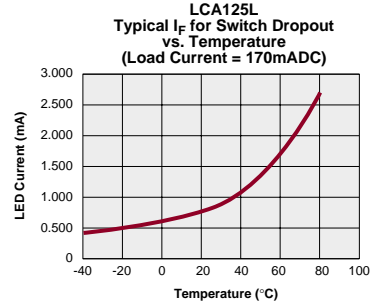
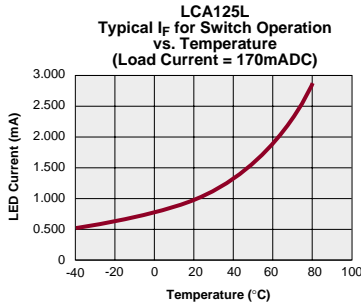
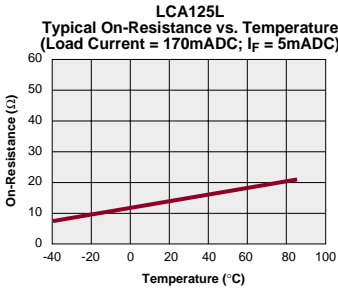
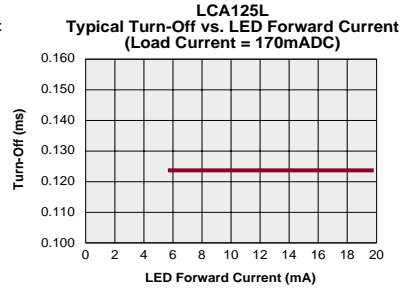
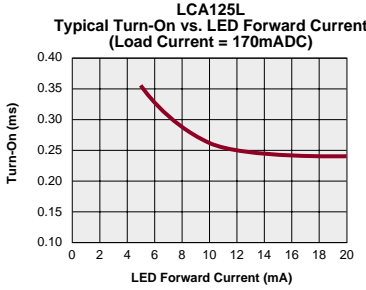
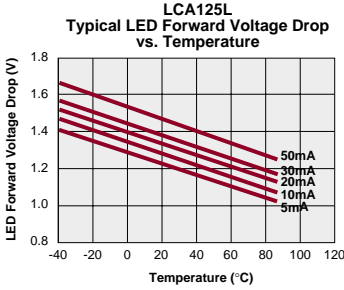

LCA126



DESCRIPTION

The LCA126 is a 250V, 170mA, 15Ω type 1-Form-A solid state relay.

FEATURES

- Small 6 Pin DIP Package
- Low Drive Power Requirements (TTL/CMOS Compatible)
- No Moving Parts
- High Reliability
- Arc-Free With No Snubbing Circuits
- 3750V_{RMS} Input/Output Isolation
- FCC Compatible
- VDE Compatible
- No EMI/RFI Generation
- Machine Insertable, Wave Solderable
- Current Limiting, Surface Mount and Tape & Reel Versions Available

APPROVALS

- UL Recognized: File Number E76270
- CSA Certified: File Number LR 43639-10
- BSI Certified to:
 - BS EN 60950:1992 (BS7002:1992)
Certificate #: 7344
 - BS EN 41003:1993
Certificate #: 7344

OPTIONS / SUFFIXES

- S: Surface Mount Package
- TR: Tape & Reel

Switching Characteristics of Normally Open (Form A) Devices

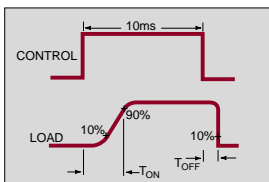

APPLICATIONS

- Telecommunications
 - Telecom Switching
 - Tip/Ring Circuits
 - Modem Switching (Laptop, Notebook, Pocket Size)
 - Hookswitch
 - Dial Pulsing
 - Ground Start
 - Ringer Injection
- Instrumentation
 - Multiplexers
 - Data Acquisition
 - Electronic Switching
 - I/O Subsystems
 - Meters (Watt-Hour, Water, Gas)
- Medical Equipment—Patient/Equipment Isolation
- Security
- Aerospace
- Industrial Controls

RATINGS (@ 25° C)

Parameter	Min	Typ	Max	Units
Input Power Dissipation	-	-	150 ¹	mW
Input Control Current	-	-	50	mA
Peak (10ms)	-	-	1	A
Reverse Input Voltage	-	-	5	V
Total Power Dissipation	-	-	800 ²	mW
Capacitance				
Input to Output	-	3	-	pF
Isolation Voltage				
Input to Output	3750	-	-	V _{RMS}
Operational Temperature	-40	-	+85	°C
Storage Temperature	-40	-	+125	°C
Soldering Temperature				
(10 Seconds Max.)				
DIP Package	-	-	+260	°C
Surface Mount Package	-	-	+220	°C

¹ Derate Linearly 1.33 mw/°C

² Derate Linearly 1.67 mw/°C

Note: For Mechanical Dimensions See Pages 396-401

SPECIFICATIONS

PARAMETERS	CONDITIONS	SYMBOL	MIN	TYP	MAX	UNITS
Output Characteristics @ 25°C						
Load Voltage (Peak)	-	V_L	-	-	250	V
Load Current (Continuous)	-	I_L	-	-	170	mA
AC/DC Configuration	-	I_L	-	-	300	mA
DC Configuration	-	I_L	-	-	300	mA
Peak Load Current	10ms	I_{LPK}	-	-	400	mA
On-Resistance	-	R_{ON}	-	-	-	Ω
AC/DC Configuration	$I_L=170mA$	R_{ON}	-	10	15	Ω
DC Configuration	$I_L=300mA$	R_{ON}	-	4	5	Ω
Off-State Leakage Current	$V_L=250V$	I_{LEAK}	-	-	1	μA
Switching Speeds	-	-	-	-	-	-
Turn-On	$I_F=5mA, V_L=10V$	T_{ON}	-	-	5	ms
Turn-Off	$I_F=5mA, V_L=10V$	T_{OFF}	-	-	5	ms
Output Capacitance	50V; f=1MHz	C_{OUT}	-	50	-	pF
Input Characteristics @ 25°C						
Input Control Current	$I_L=170mA$	I_F	5	-	50	mA
Input Dropout Current	-	I_F	0.4	0.7	-	mA
Input Voltage Drop	$I_F=5mA$	V_F	0.9	1.2	1.4	V
Reverse Input Voltage	-	V_R	-	-	5	V
Reverse Input Current	$V_R=5V$	I_R	-	-	10	μA
Input to Output Capacitance	-	$C_{I/O}$	-	3	-	pF
Input to Output Isolation	-	$V_{I/O}$	3750	-	-	V_{RMS}

LCA126 Pinout

AC/DC Configuration

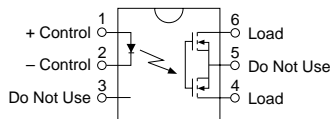

LCA126 Pinout

DC Only Configuration

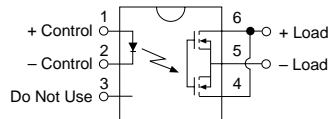

Note: For Mechanical Dimensions See Pages 396-401

LCA126

PERFORMANCE DATA

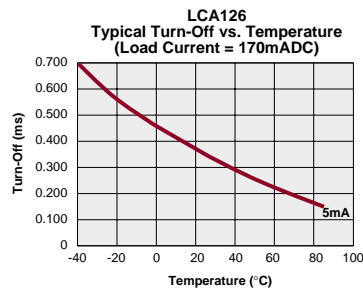
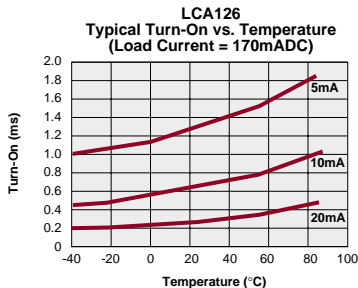
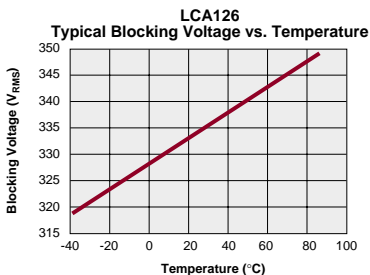
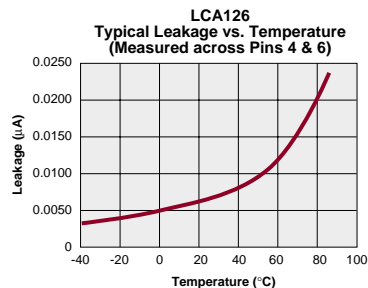
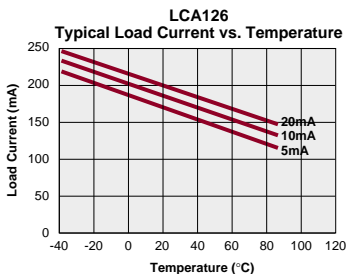
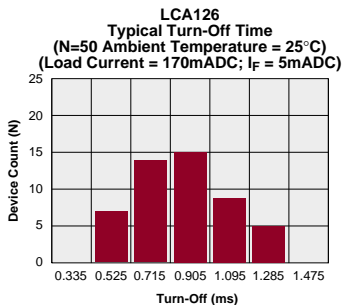
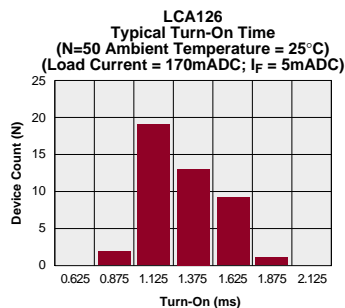
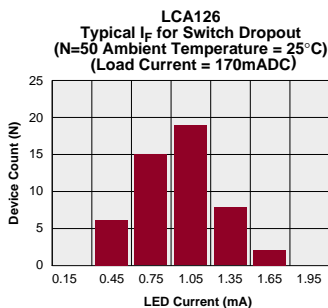
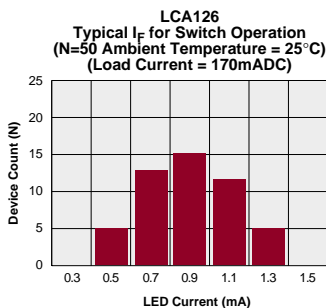
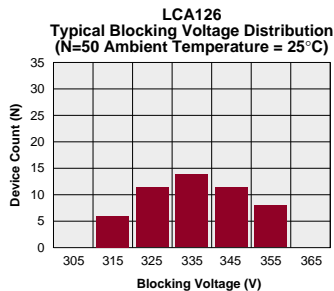
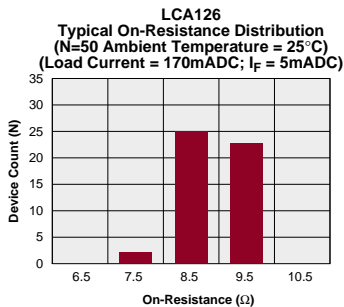
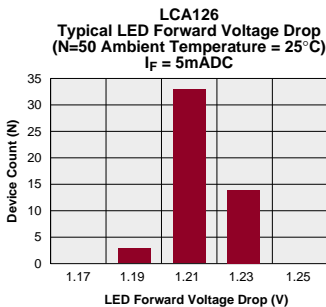

PERFORMANCE DATA

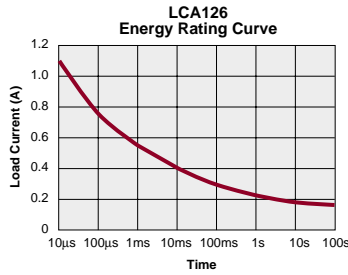
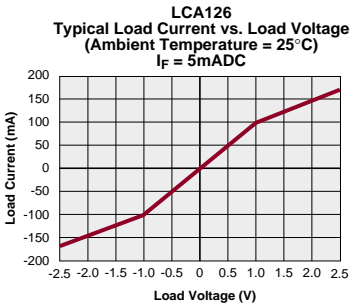
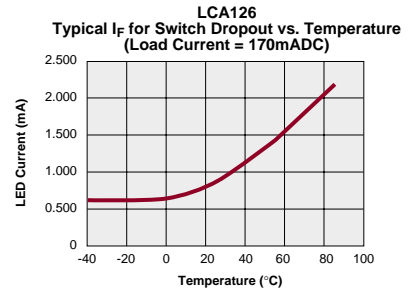
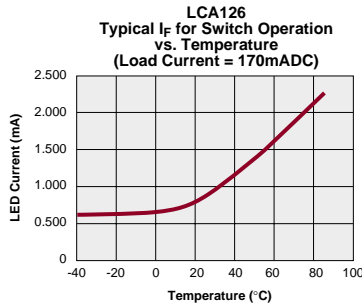
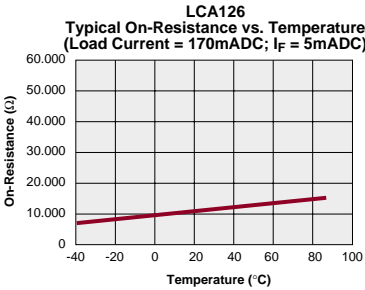
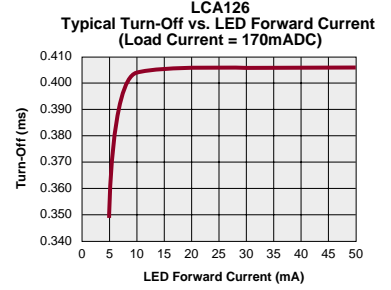
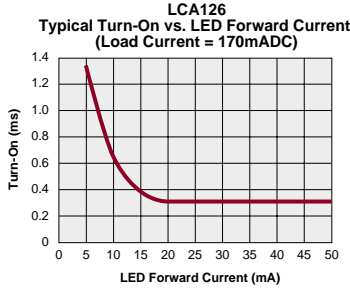
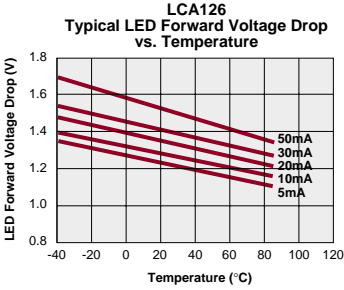

LCA127/LCA127L



FEATURES

- Small 6 Pin DIP Package
- Low Drive Power Requirements (TTL/CMOS Compatible)
- No Moving Parts
- High Reliability
- Arc-Free With No Snubbing Circuits
- 3750V_{RMS} Input/Output Isolation
- FCC Compatible
- VDE Compatible
- No EMI/RFI Generation
- Machine Insertable, Wave Solderable
- Current Limiting, Surface Mount and Tape & Reel Versions Available

APPROVALS

- UL Recognized: File Number E76270
- CSA Certified: File Number LR 43639-10
- BSI Certified to:
 - BS EN 60950:1992 (BS7002:1992) Certificate #: 7344
 - BS EN 41003:1993 Certificate #: 7344

OPTIONS / SUFFIXES

- L: Current Limiting
- S: Surface Mount Package
- TR: Tape & Reel

Switching Characteristics of Normally Open (Form A) Devices

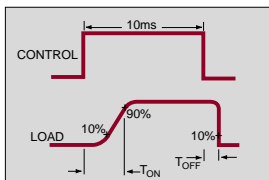

DESCRIPTION

The LCA127 is a 250V, 200mA, 10Ω type 1-Form-A solid state relay. Current limiting version available. ("L" suffix).

APPLICATIONS

- Telecommunications
 - Telecom Switching
 - Tip/Ring Circuits
 - Modem Switching (Laptop, Notebook, Pocket Size)
 - Hookswitch
 - Dial Pulsing
 - Ground Start
 - Ringer Injection
- Instrumentation
 - Multiplexers
 - Data Acquisition
 - Electronic Switching
 - I/O Subsystems
 - Meters (Watt-Hour, Water, Gas)
- Medical Equipment—Patient/Equipment Isolation
- Security
- Aerospace
- Industrial Controls

RATINGS (@ 25° C)

Parameter	Min	Typ	Max	Units
Input Power Dissipation	-	-	150 ¹	mW
Input Control Current	-	-	50	mA
Peak (10ms)	-	-	1	A
Reverse Input Voltage	-	-	5	V
Total Power Dissipation	-	-	800 ²	mW
Capacitance				
Input to Output	-	3	-	pF
Isolation Voltage				
Input to Output	3750	-	-	V _{RMS}
Operational Temperature	-40	-	+85	°C
Storage Temperature	-40	-	+125	°C
Soldering Temperature (10 Seconds Max.)				
DIP Package	-	-	+260	°C
Surface Mount Package	-	-	+220	°C

¹ Derate Linearly 1.33 mw/°C

² Derate Linearly 1.67 mw/°C

Note: For Mechanical Dimensions See Pages 396-401

SPECIFICATIONS

PARAMETERS	CONDITIONS	SYMBOL	LCA127			LCA127L			UNITS
			MIN	TYP	MAX	MIN	TYP	MAX	
Output Characteristics @ 25°C									
Load Voltage (Peak)	-	V_L	-	-	250	-	-	250	V
Load Current (Continuous)	-	I_L	-	-	200	-	-	170	mA
AC/DC Configuration	-	I_L	-	-	350	-	-	250	mA
DC Configuration	-	I_L	-	-	400	-	-	-	mA
Peak Load Current	10ms	I_L	-	-	400	-	-	-	mA
On-Resistance	-	R_{ON}	-	-	-	-	-	-	Ω
AC/DC Configuration	I_L =Load Current	R_{ON}	-	8	10	-	13	15	Ω
DC Configuration	I_L =Load Current	R_{ON}	-	2	3	-	5	6	Ω
Off-State Leakage Current	V_L =250V	I_{LEAK}	-	-	1	-	-	1	μ A
Switching Speeds	-	-	-	-	-	-	-	-	-
Turn-On	I_F =5mA, V_L =10V	T_{ON}	-	-	5	-	-	5	ms
Turn-Off	I_F =5mA, V_L =10V	T_{OFF}	-	-	5	-	-	5	ms
Output Capacitance	50V; f=1MHz	C_{OUT}	-	50	-	-	50	-	pF
Load Current Limiting	-	I_{CL}	-	-	-	190	235	280	mA
Input Characteristics @ 25°C									
Input Control Current	I_L =Load Current	I_F	5	-	50	5	-	50	mA
Input Dropout Current	-	I_F	0.4	0.7	-	0.4	0.7	-	mA
Input Voltage Drop	I_F =5mA	V_F	0.9	1.2	1.4	0.9	1.2	1.4	V
Reverse Input Voltage	-	V_R	-	-	5	-	-	5	V
Reverse Input Current	V_R =5V	I_R	-	-	10	-	-	10	μ A
Input to Output Capacitance	-	$C_{I/O}$	-	3	-	-	3	-	pF
Input to Output Isolation	-	$V_{I/O}$	3750	-	-	3750	-	-	V_{RMS}

LCA127/L127L Pinout

AC/DC Configuration

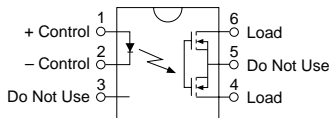

LCA127/LCA127L Pinout

DC Only Configuration

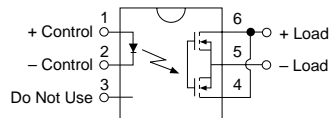

Note: For Mechanical Dimensions See Pages 396-401

LCA127/LCA127L

PERFORMANCE DATA

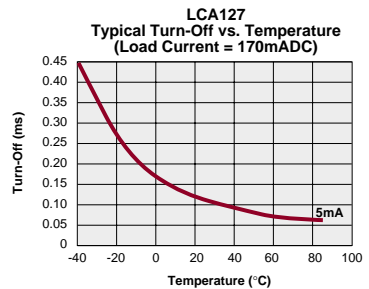
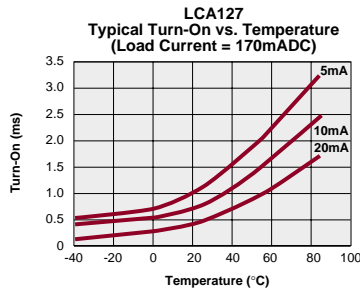
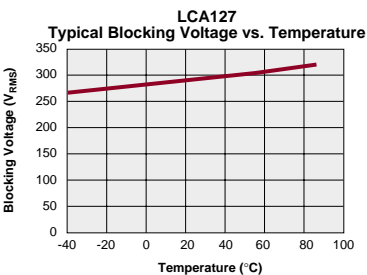
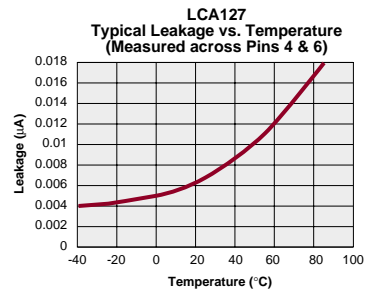
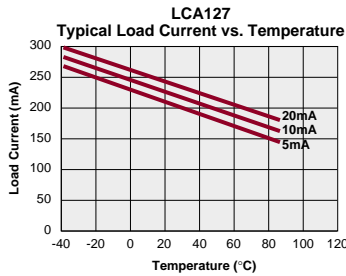
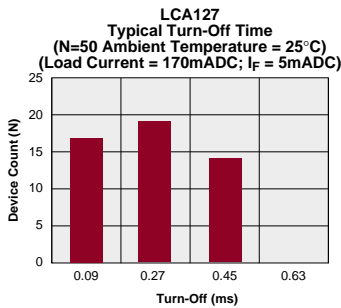
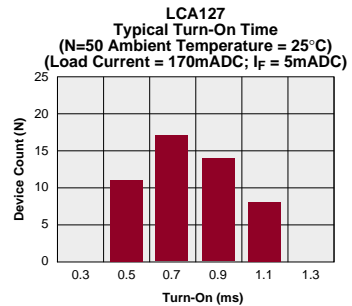
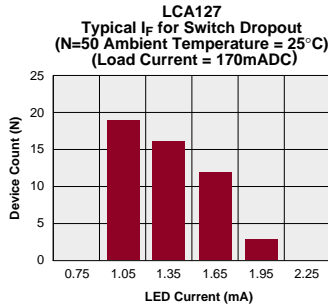
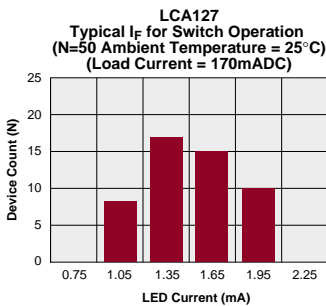
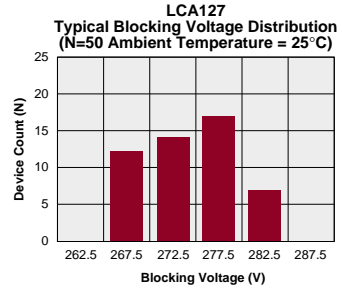
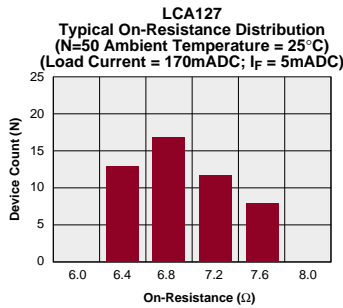
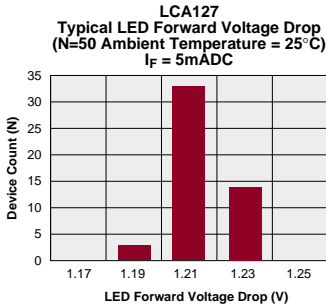

PERFORMANCE DATA

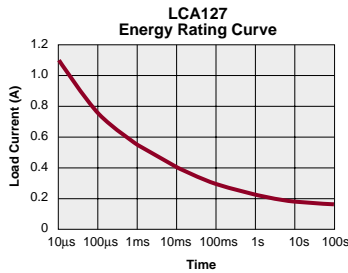
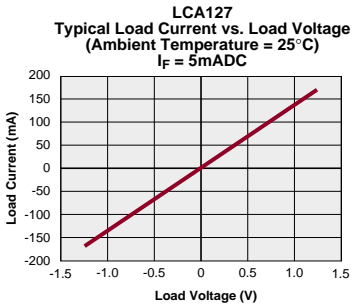
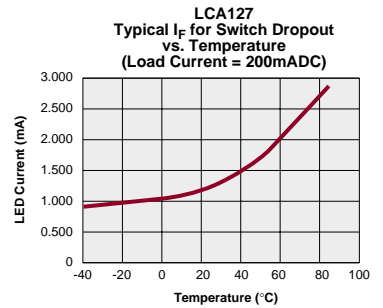
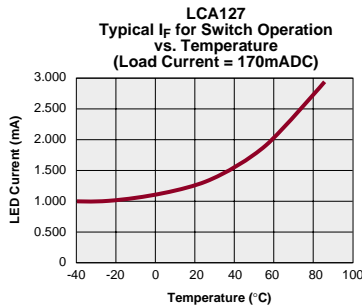
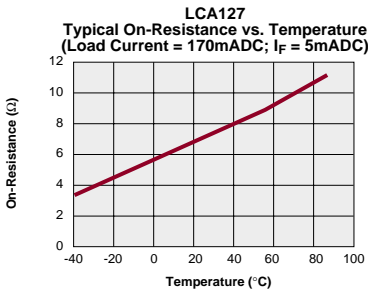
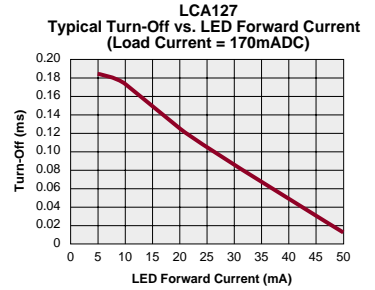
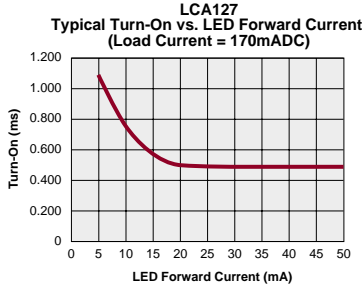
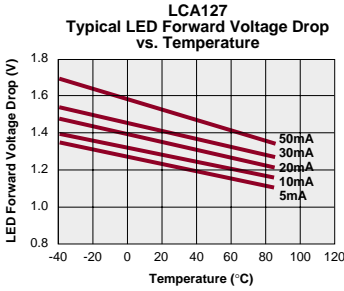

LCA127/LCA127L

PERFORMANCE DATA

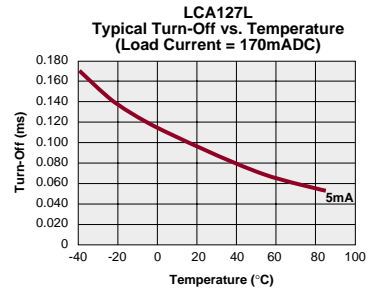
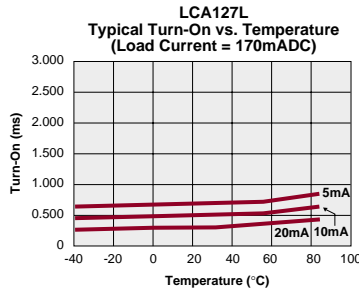
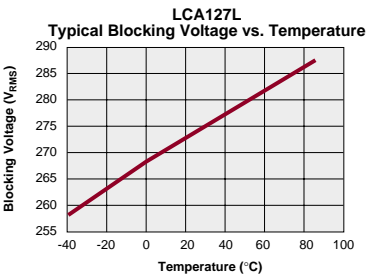
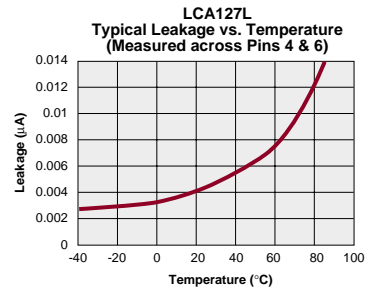
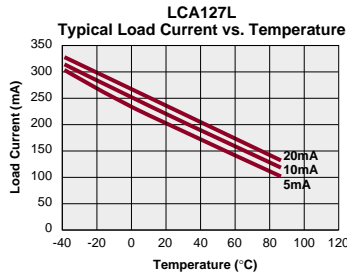
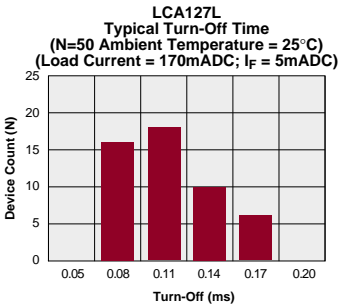
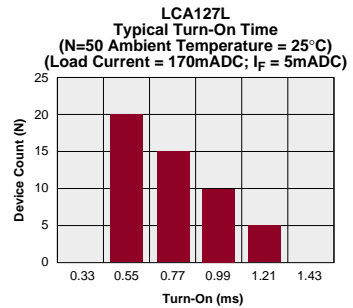
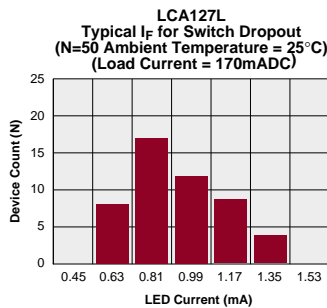
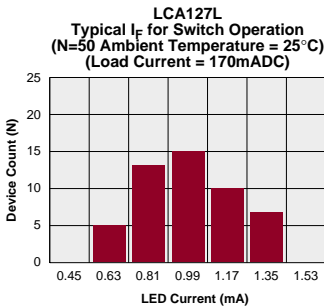
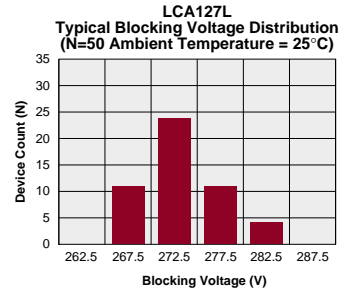
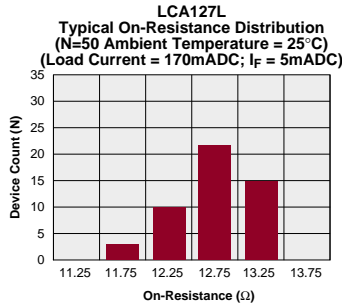
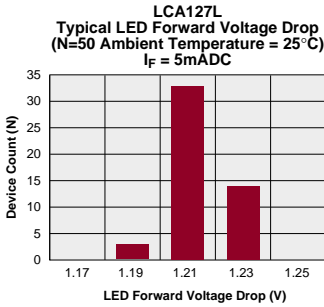

PERFORMANCE DATA

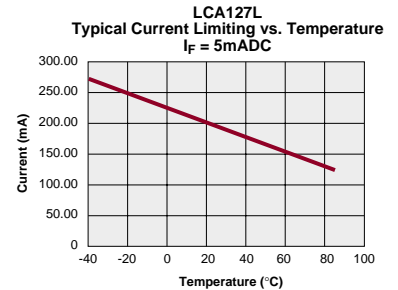
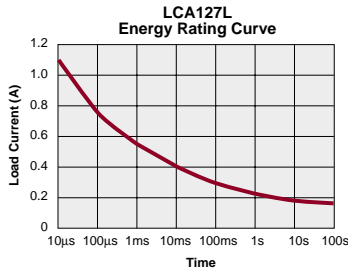
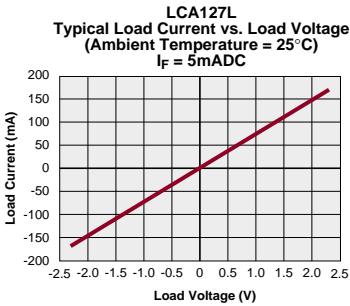
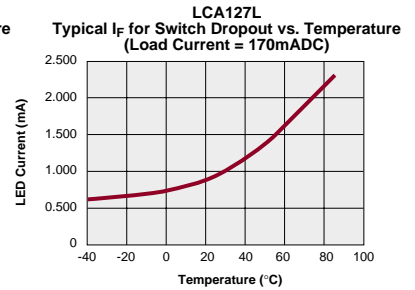
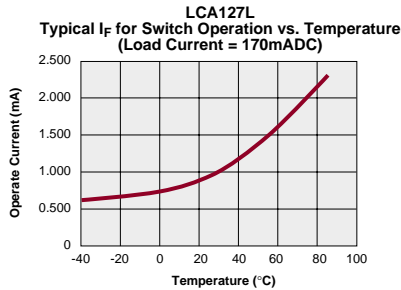
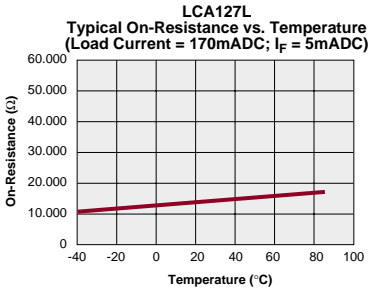
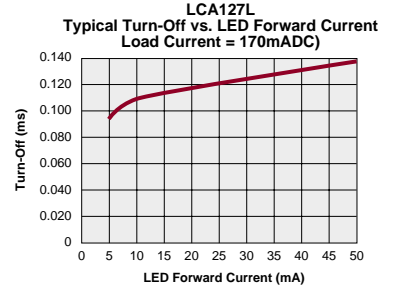
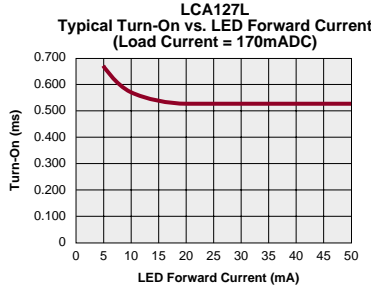
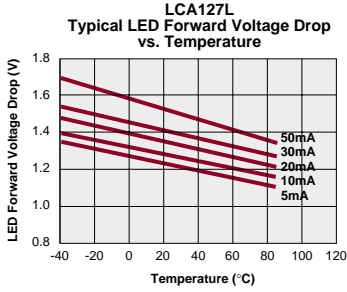

LCA710



DESCRIPTION

The LCA710 is a 60V, 1A, 0.5Ω type 1-Form-A solid state relay.

FEATURES

- Small 6 Pin DIP Package
- Low Drive Power Requirements (TTL/CMOS Compatible)
- No Moving Parts
- High Reliability
- Arc-Free With No Snubbing Circuits
- 3750V_{RMS} Input/Output Isolation
- FCC Compatible
- VDE Compatible
- No EMI/RFI Generation
- Machine Insertable, Wave Solderable
- Current Limiting, Surface Mount and Tape & Reel Versions Available

APPROVALS

- UL Recognized: File Number E76270
- CSA Certified: File Number LR 43639-10
- BSI Certified to:
 - BS EN 60950:1992 (BS7002:1992) Certificate #: 7344
 - BS EN 41003:1993 Certificate #: 7344

OPTIONS / SUFFIXES

- S: Surface Mount Package
- TR: Tape & Reel

Switching Characteristics of Normally Open (Form A) Devices

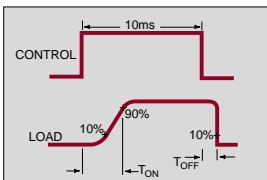

APPLICATIONS

- Telecommunications
 - Telecom Switching
 - Tip/Ring Circuits
 - Modem Switching (Laptop, Notebook, Pocket Size)
 - Hookswitch
 - Dial Pulsing
 - Ground Start
 - Ringer Injection
- Instrumentation
 - Multiplexers
 - Data Acquisition
 - Electronic Switching
 - I/O Subsystems
 - Meters (Watt-Hour, Water, Gas)
- Medical Equipment—Patient/Equipment Isolation
- Security
- Aerospace
- Industrial Controls

RATINGS (@ 25°C)

Parameter	Min	Typ	Max	Units
Input Power Dissipation	-	-	150 ¹	mW
Input Control Current	-	-	50	mA
Peak (10ms)	-	-	1	A
Reverse Input Voltage	-	-	5	V
Total Power Dissipation	-	-	800 ²	mW
Capacitance				
Input to Output	-	3	-	pF
Isolation Voltage				
Input to Output	3750	-	-	V _{RMS}
Operational Temperature	-40	-	+85	°C
Storage Temperature	-40	-	+125	°C
Soldering Temperature (10 Seconds Max.)				
DIP Package	-	-	+260	°C
Surface Mount Package	-	-	+220	°C

¹ Derate Linearly 1.33 mw/°C

² Derate Linearly 1.67 mw/°C

Note: For Mechanical Dimensions See Pages 396-401

SPECIFICATIONS

PARAMETERS	CONDITIONS	SYMBOL	MIN	TYP	MAX	UNITS
Output Characteristics @ 25°C						
Load Voltage (Peak)	-	V_L	-	-	60	V
Load Current (Continuous)						
AC/DC Configuration	-	I_L	-	-	1.0	A
DC Configuration	-	I_L	-	-	1.8	A
Peak Load Current	10ms	I_{LPK}	-	-	5.0	A
On-Resistance						
AC/DC Configuration	$I_L=1A$	R_{ON}	-	0.3	0.5	Ω
DC Configuration	$I_L=1.8A$	R_{ON}	-	0.1	0.15	Ω
Off-State Leakage Current	$V_L=60V$	I_{LEAK}	-	-	1	μA
Switching Speeds						
Turn-On	$I_F=10mA, V_L=10V$	T_{ON}	-	-	2.5	ms
Turn-Off	$I_F=10mA, V_L=10V$	T_{OFF}	-	-	0.25	ms
Output Capacitance	50V; f=1MHz	-	-	220	-	pF
Input Characteristics @ 25°C						
Input Control Current	$I_L=1A$	I_F	10	-	50	mA
Input Dropout Current	-	I_F	0.4	0.7	-	mA
Input Voltage Drop	$I_F=10mA$	V_F	0.9	1.2	1.4	V
Reverse Input Voltage	-	V_R	-	-	5	V
Reverse Input Current	$V_R=5V$	I_R	-	-	10	μA
Input to Output Capacitance	-	$C_{I/O}$	-	3	-	pF
Input to Output Isolation	-	$V_{I/O}$	3750	-	-	V_{RMS}

LCA710 Pinout

AC/DC Configuration

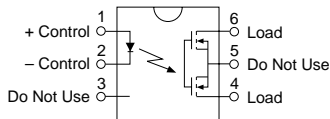

LCA710 Pinout

DC Only Configuration

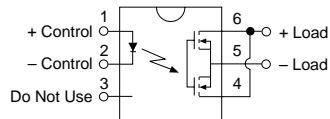

Note: For Mechanical Dimensions See Pages 396-401

LCA710

PERFORMANCE DATA

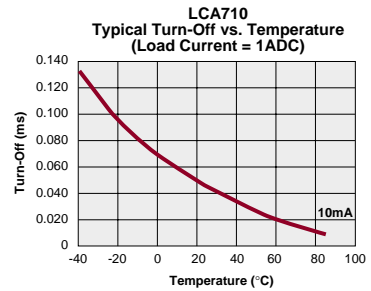
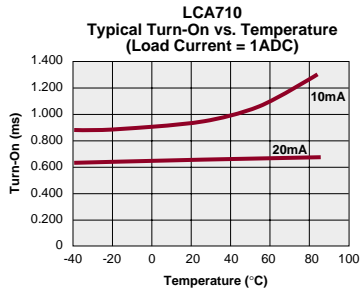
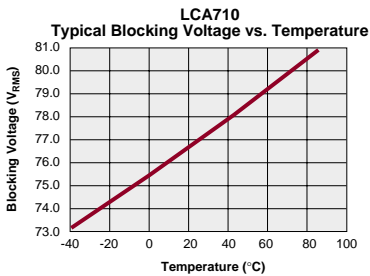
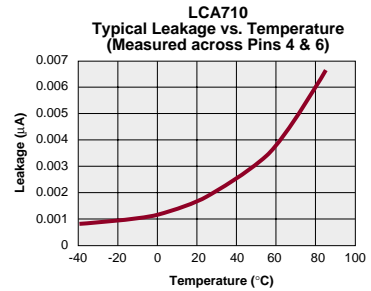
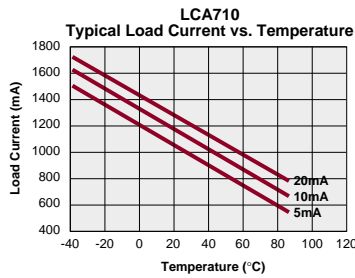
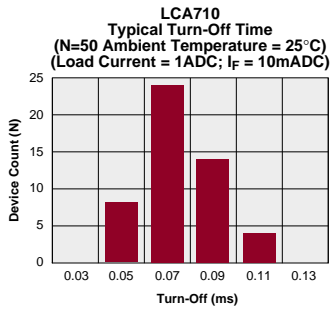
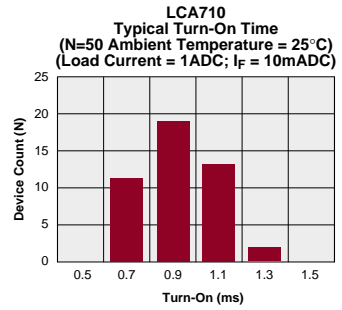
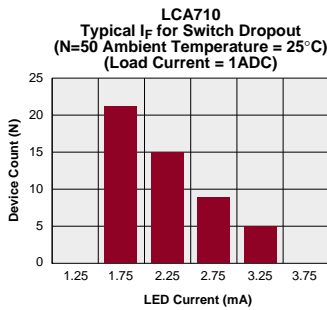
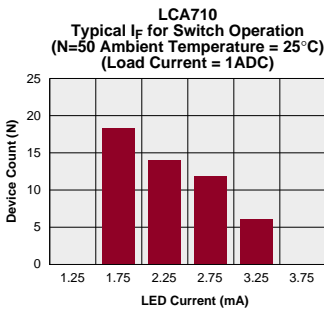
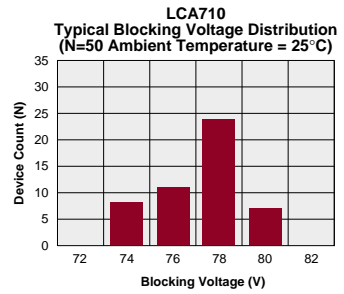
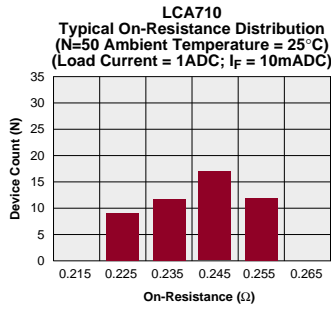
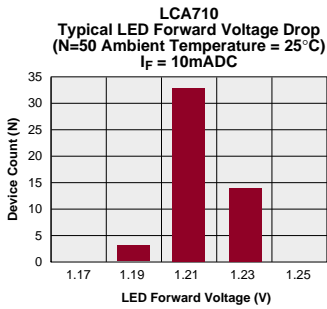

PERFORMANCE DATA

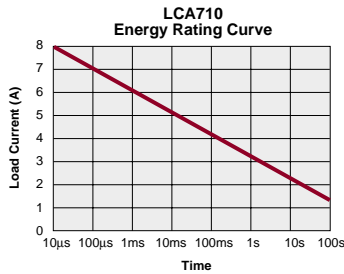
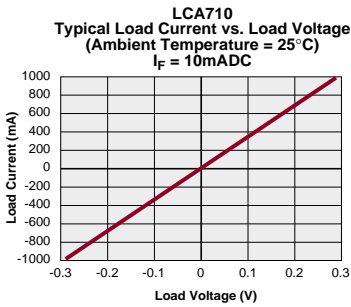
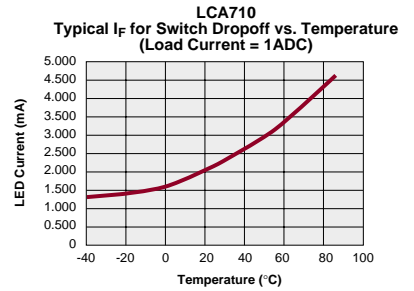
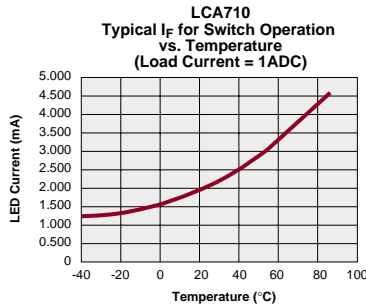
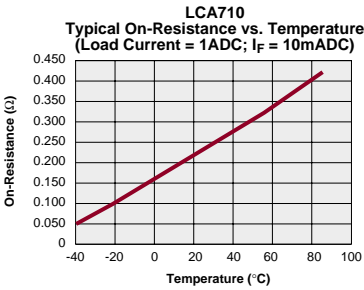
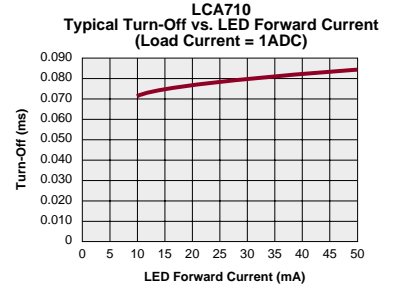
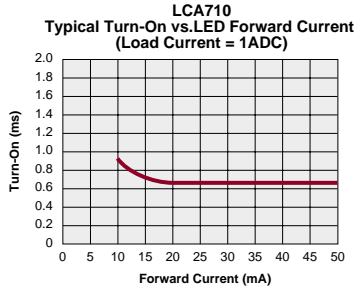
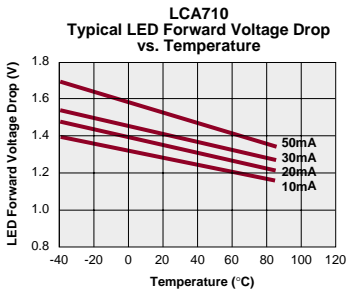

LCB110



DESCRIPTION

The LCB110 is a 350V, 120mA, 35Ω type 1-Form-B solid state relay.

FEATURES

- Small 6 Pin DIP Package
- Low Drive Power Requirements (TTL/CMOS Compatible)
- No Moving Parts
- High Reliability
- Arc-Free With No Snubbing Circuits
- 3750V_{RMS} Input/Output Isolation
- FCC Compatible
- VDE Compatible
- No EMI/RFI Generation
- Machine Insertable, Wave Solderable
- Current Limiting, Surface Mount and Tape & Reel Versions Available

APPROVALS

- UL Recognized: File Number E76270
- CSA Certified: File Number LR 43639-10
- BSI Certified to:
 - BS EN 60950:1992 (BS7002:1992) Certificate #: 7344
 - BS EN 41003:1993 Certificate #: 7344

OPTIONS / SUFFIXES

- S: Surface Mount Package
- TR: Tape & Reel

Switching Characteristics of Normally Closed (Form B) Devices

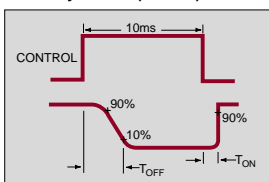

APPLICATIONS

- Telecommunications
 - Telecom Switching
 - Tip/Ring Circuits
 - Modem Switching (Laptop, Notebook, Pocket Size)
 - Hookswitch
 - Dial Pulsing
 - Ground Start
 - Ringer Injection
- Instrumentation
 - Multiplexers
 - Data Acquisition
 - Electronic Switching
 - I/O Subsystems
 - Meters (Watt-Hour, Water, Gas)
- Medical Equipment-Patient/Equipment Isolation
- Security
- Aerospace
- Industrial Controls

RATINGS (@ 25° C)

Parameter	Min	Typ	Max	Units
Input Power Dissipation	-	-	150 ¹	mW
Input Control Current	-	-	50	mA
Peak (10ms)	-	-	1	A
Reverse Input Voltage	-	-	5	V
Total Power Dissipation	-	-	800 ²	mW
Capacitance				
Input to Output	-	3	-	pF
Isolation Voltage				
Input to Output	3750	-	-	V _{RMS}
Operational Temperature	-40	-	+85	°C
Storage Temperature	-40	-	+125	°C
Soldering Temperature (10 Seconds Max.)				
DIP Package	-	-	+260	°C
Surface Mount Package	-	-	+220	°C

¹ Derate Linearly 1.33 mw/°C

² Derate Linearly 1.67 mw/°C

Note: For Mechanical Dimensions See Pages 396-401

SPECIFICATIONS

PARAMETERS	CONDITIONS	SYMBOL	MIN	TYP	MAX	UNITS
Output Characteristics @ 25°C						
Load Voltage (Peak)	-	V_L	-	-	350	V
Load Current (Continuous)	-	I_L	-	-	120	mA
AC/DC Configuration	-	I_L	-	-	120	mA
DC Configuration	-	I_L	-	-	200	mA
Peak Load Current	10ms	I_L	-	-	350	mA
On-Resistance	-	R_{ON}	-	-	-	Ω
AC/DC Configuration	$I_L=120mA$	R_{ON}	-	23	35	Ω
DC Configuration	$I_L=200mA$	R_{ON}	-	7	10	Ω
Off-State Leakage Current	$V_L=350V$	I_{LEAK}	-	-	1	μA
Switching Speeds	-	T_{ON}	-	-	3	ms
Turn-On	$I_F=5mA, V_L=10V$	T_{ON}	-	-	3	ms
Turn-Off	$I_F=5mA, V_L=10V$	T_{OFF}	-	-	3	ms
Output Capacitance	50V; f=1MHz	C_{OUT}	-	25	-	pF
Input Characteristics @ 25°C						
Input Control Current	$I_L=120mA$	I_F	5	-	50	mA
Input Dropout Current	-	I_F	0.4	0.7	-	mA
Input Voltage Drop	$I_F=5mA$	V_F	0.9	1.2	1.4	V
Reverse Input Voltage	-	V_R	-	-	5	V
Reverse Input Current	$V_R=5V$	I_R	-	-	10	μA
Input to Output Capacitance	-	$C_{I/O}$	-	3	-	pF
Input to Output Isolation	-	$V_{I/O}$	3750	-	-	V_{RMS}

LCB110 Pinout

AC/DC Configuration

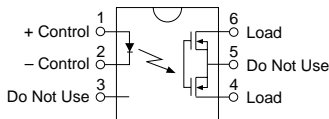

LCB110 Pinout

DC Only Configuration

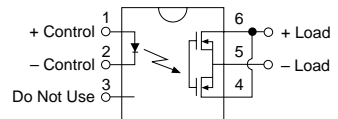

Note: For Mechanical Dimensions See Pages 396-401

www.cpcclare.com

LCB110

PERFORMANCE DATA

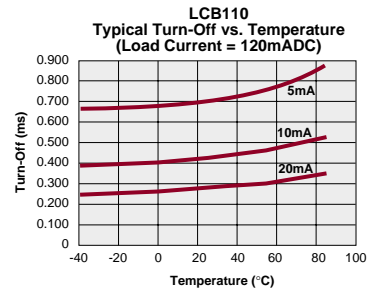
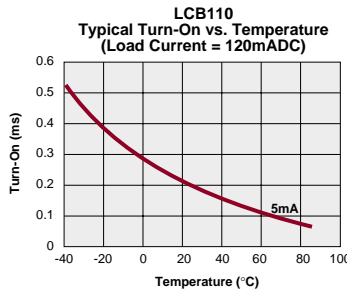
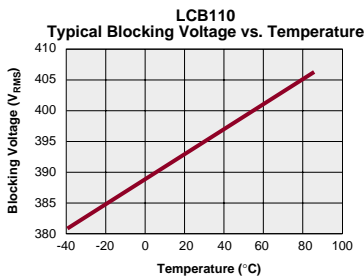
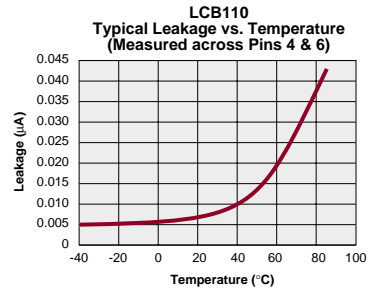
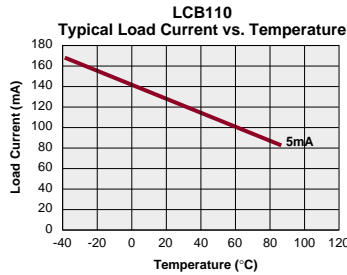
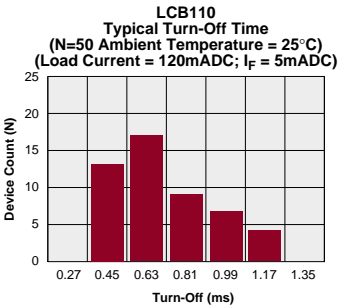
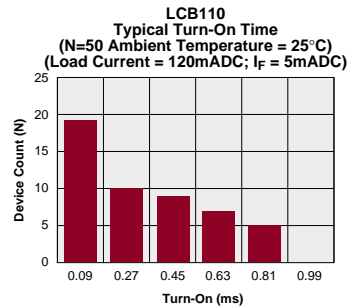
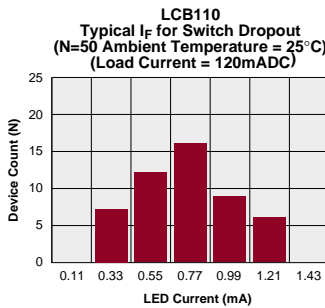
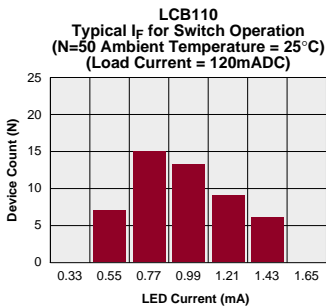
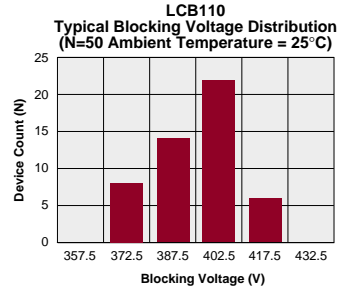
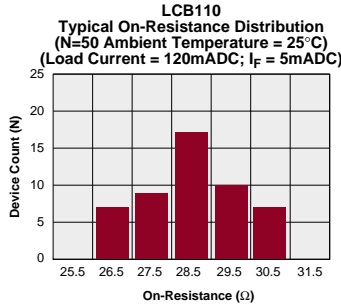
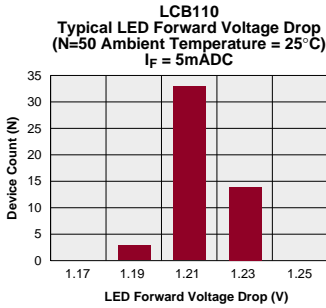

PERFORMANCE DATA

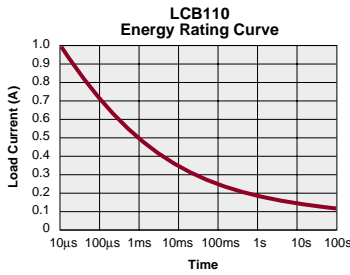
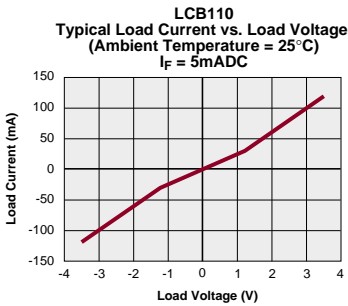
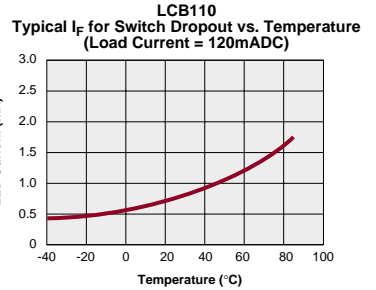
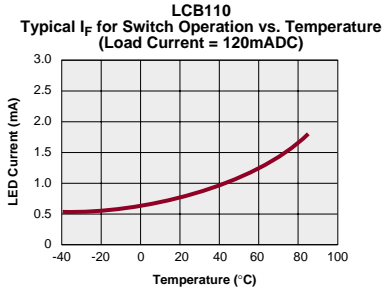
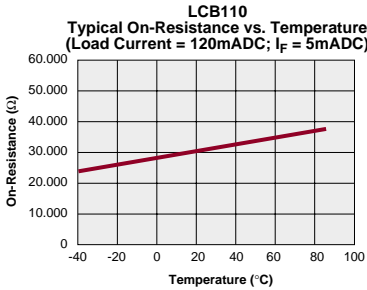
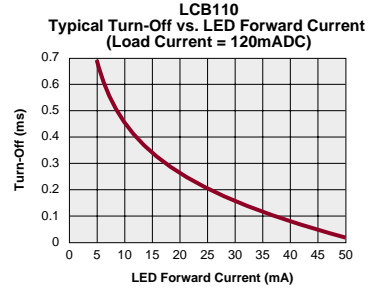
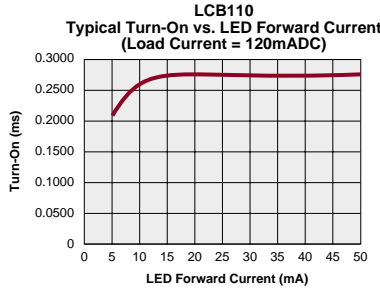
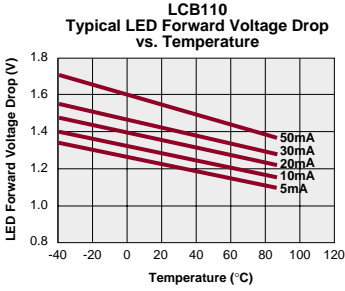

LCB120



DESCRIPTION

The LCB120 is a 250V, 170mA, 20Ω type 1-Form-B solid state relay.

FEATURES

- Small 6 Pin DIP Package
- Low Drive Power Requirements (TTL/CMOS Compatible)
- No Moving Parts
- High Reliability
- Arc-Free With No Snubbing Circuits
- 3750V_{RMS} Input/Output Isolation
- FCC Compatible
- VDE Compatible
- No EMI/RFI Generation
- Machine Insertable, Wave Solderable
- Current Limiting, Surface Mount and Tape & Reel Versions Available

APPROVALS

- UL Recognized: File Number E76270
- CSA Certified: File Number LR 43639-10
- BSI Certified to:
 - BS EN 60950:1992 (BS7002:1992) Certificate #: 7344
 - BS EN 41003:1993 Certificate #: 7344

OPTIONS / SUFFIXES

- S: Surface Mount Package
- TR: Tape & Reel

Switching Characteristics of Normally Closed (Form B) Devices

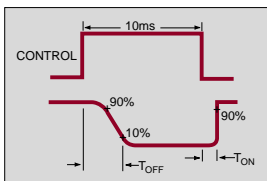

APPLICATIONS

- Telecommunications
 - Telecom Switching
 - Tip/Ring Circuits
 - Modem Switching (Laptop, Notebook, Pocket Size)
 - Hookswitch
 - Dial Pulsing
 - Ground Start
 - Ringer Injection
- Instrumentation
 - Multiplexers
 - Data Acquisition
 - Electronic Switching
 - I/O Subsystems
 - Meters (Watt-Hour, Water, Gas)
- Medical Equipment-Patient/Equipment Isolation
- Security
- Aerospace
- Industrial Controls

RATINGS (@ 25°C)

Parameter	Min	Typ	Max	Units
Input Power Dissipation	-	-	150 ¹	mW
Input Control Current	-	-	50	mA
Peak (10ms)	-	-	1	A
Reverse Input Voltage	-	-	5	V
Total Power Dissipation	-	-	800 ²	mW
Capacitance				
Input to Output	-	3	-	pF
Isolation Voltage				
Input to Output	3750	-	-	V _{RMS}
Operational Temperature	-40	-	+85	°C
Storage Temperature	-40	-	+125	°C
Soldering Temperature (10 Seconds Max.)				
DIP Package	-	-	+260	°C
Surface Mount Package	-	-	+220	°C

¹ Derate Linearly 1.33 mw/°C

² Derate Linearly 1.67 mw/°C

Note: For Mechanical Dimensions See Pages 396-401

SPECIFICATIONS

PARAMETERS	CONDITIONS	SYMBOL	MIN	TYP	MAX	UNITS
Output Characteristics @ 25°C						
Load Voltage (Peak)	-	V_L	-	-	250	V
Load Current (Continuous)						
AC/DC Configuration	-	I_L	-	-	170	mA
DC Configuration	-	I_L	-	-	300	mA
Peak Load Current	-	I_L	-	-	400	mA
On-Resistance						
AC/DC Configuration	$I_L=170\text{mA}$	R_{ON}	-	16	20	Ω
DC Configuration	$I_L=300\text{mA}$	R_{ON}	-	5	6	Ω
Off-State Leakage Current	$V_L=250\text{V}$	I_{LEAK}	-	-	1	μA
Switching Speeds						
Turn-On	$I_F=5\text{mA}, V_L=10\text{V}$	T_{ON}	-	-	5	ms
Turn-Off	$I_F=5\text{mA}, V_L=10\text{V}$	T_{OFF}	-	-	5	ms
Output Capacitance	50V; f=1MHz	C_{OUT}	-	50	-	pF
Input Characteristics @ 25°C						
Input Control Current	$I_L=170\text{mA}$	I_F	5	-	50	mA
Input Dropout Current	-	I_F	0.4	0.7	-	mA
Input Voltage Drop	$I_F=5\text{mA}$	V_F	0.9	1.2	1.4	V
Reverse Input Voltage	-	V_R	-	-	5	V
Reverse Input Current	$V_R=5\text{V}$	I_R	-	-	10	μA
Input to Output Capacitance	-	$C_{I/O}$	-	3	-	pF
Input to Output Isolation	-	$V_{I/O}$	3750	-	-	V_{RMS}

LCB120 Pinout

AC/DC Configuration

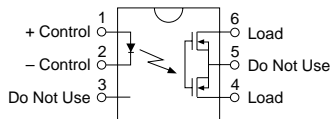

LCB120 Pinout

DC Only Configuration

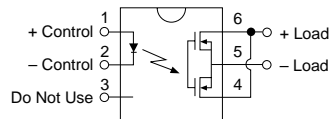

Note: For Mechanical Dimensions See Pages 396-401

www.cpcclare.com

LCB120

PERFORMANCE DATA

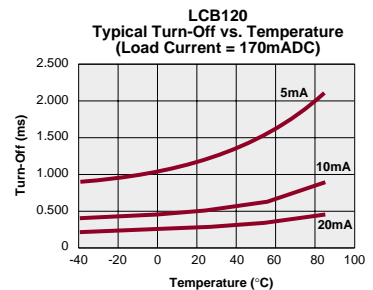
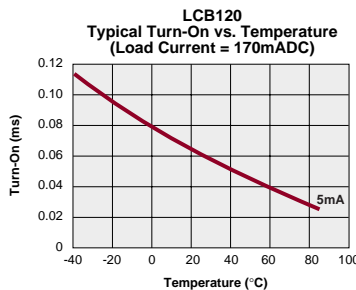
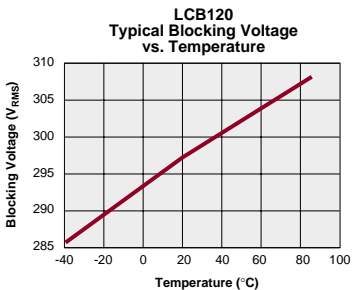
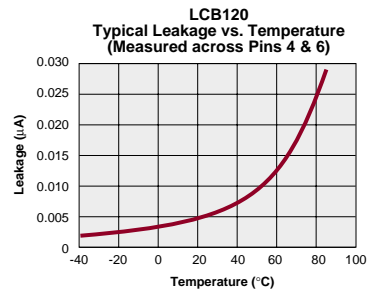
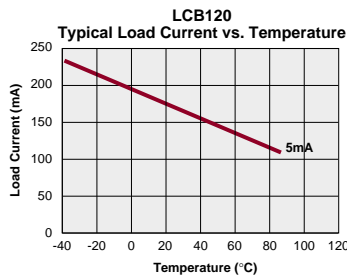
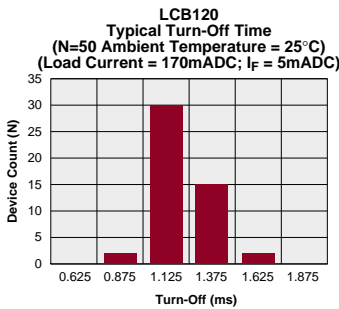
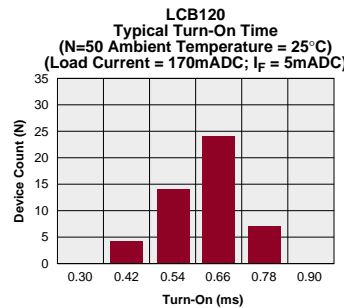
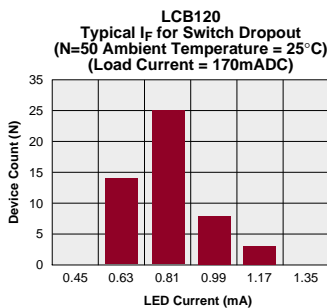
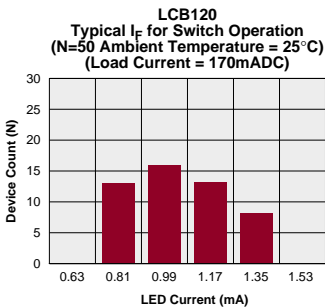
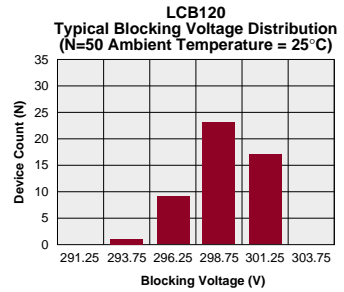
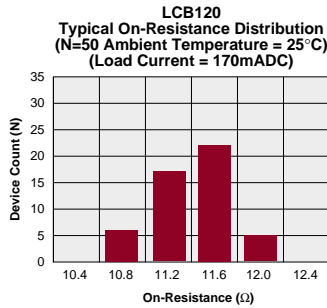
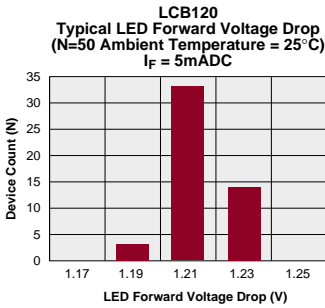

PERFORMANCE DATA

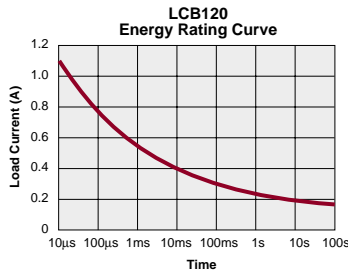
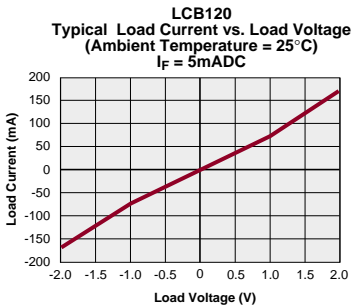
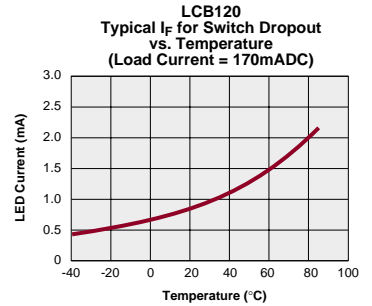
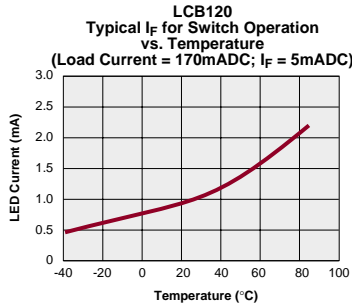
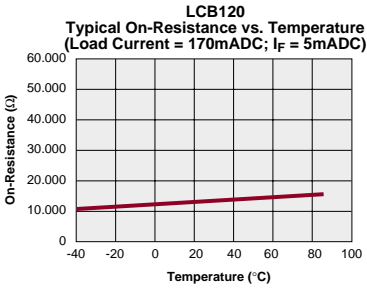
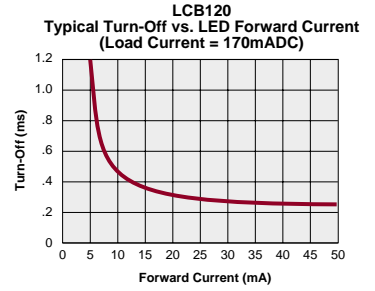
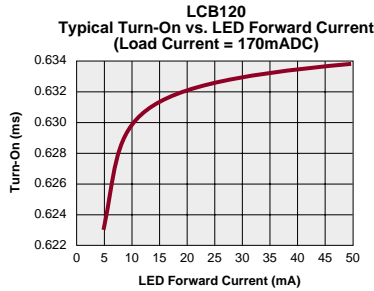
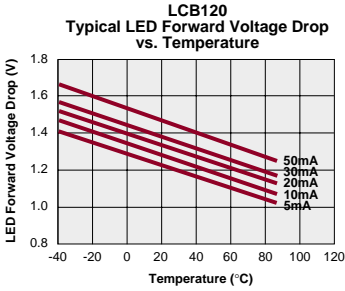

LCB126



DESCRIPTION

The LCB126 is a 250V, 170mA, 15Ω type 1-Form-B solid state relay.

FEATURES

- Small 6 Pin DIP Package
- Low Drive Power Requirements (TTL/CMOS Compatible)
- No Moving Parts
- High Reliability
- Arc-Free With No Snubbing Circuits
- 3750V_{RMS} Input/Output Isolation
- FCC Compatible
- VDE Compatible
- No EMI/RFI Generation
- Machine Insertable, Wave Solderable
- Current Limiting, Surface Mount and Tape & Reel Version Available

APPROVALS

- UL Recognized: File Number E76270
- CSA Certified: File Number LR 43639-10
- BSI Certified to:
 - BS EN 60950:1992 (BS7002:1992) Certificate #: 7344
 - BS EN 41003:1993 Certificate #: 7344

OPTIONS / SUFFIXES

- S: Surface Mount Package
- TR: Tape & Reel

Switching Characteristics of Normally Closed (Form B) Devices

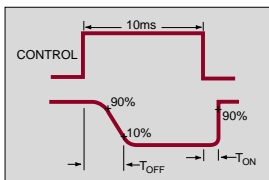

APPLICATIONS

- Telecommunications
 - Telecom Switching
 - Tip/Ring Circuits
 - Modem Switching (Laptop, Notebook, Pocket Size)
 - Hookswitch
 - Dial Pulsing
 - Ground Start
 - Ringer Injection
- Instrumentation
 - Multiplexers
 - Data Acquisition
 - Electronic Switching
 - I/O Subsystems
 - Meters (Watt-Hour, Water, Gas)
- Medical Equipment-Patient/Equipment Isolation
- Security
- Aerospace
- Industrial Controls

RATINGS (@ 25° C)

Parameter	Min	Typ	Max	Units
Input Power Dissipation	-	-	150 ¹	mW
Input Control Current	-	-	50	mA
Peak (10ms)	-	-	1	A
Reverse Input Voltage	-	-	5	V
Total Power Dissipation	-	-	800 ²	mW
Capacitance				
Input to Output	-	3	-	pF
Isolation Voltage				
Input to Output	3750	-	-	V _{RMS}
Operational Temperature	-40	-	+85	°C
Storage Temperature	-40	-	+125	°C
Soldering Temperature (10 Seconds Max.)				
DIP Package	-	-	+260	°C
Surface Mount Package	-	-	+220	°C

¹ Derate Linearly 1.33 mw/°C

² Derate Linearly 1.67 mw/°C

Note: For Mechanical Dimensions See Pages 396-401

SPECIFICATIONS

PARAMETERS	CONDITIONS	SYMBOL	MIN	TYP	MAX	UNITS
Output Characteristics @ 25°C						
Load Voltage (Peak)	-	V_L	-	-	250	V
Load Current (Continuous)	-	I_L	-	-	170	mA
AC/DC Configuration	-	I_L	-	-	300	mA
DC Configuration	-	I_L	-	-	400	mA
Peak Load Current	10ms	I_L	-	-	400	mA
On-Resistance						
AC/DC Configuration	$I_L=170\text{mA}$	R_{ON}	-	10	15	Ω
DC Configuration	$I_L=300\text{mA}$	R_{ON}	-	4	5	Ω
Off-State Leakage Current	$V_L=250\text{V}$	I_{LEAK}	-	-	1	μA
Switching Speeds						
Turn-On	$I_F=5\text{mA}, V_L=10\text{V}$	T_{ON}	-	-	5	m
Turn-Off	$I_F=5\text{mA}, V_L=10\text{V}$	T_{OFF}	-	-	5	ms
Output Capacitance	50V; f=1MHz	C_{OUT}	-	50	-	pF
Input Characteristics @ 25°C						
Input Control Current	$I_L=170\text{mA}$	I_F	5	-	50	mA
Input Dropout Current	-	I_F	0.4	0.7	-	mA
Input Voltage Drop	$I_F=5\text{mA}$	V_F	0.9	1.2	1.4	V
Reverse Input Voltage	-	V_R	-	-	5	V
Reverse Input Current	-	-	10	μA	-	
Input to Output Capacitance	-	$C_{I/O}$	-	3	-	pF
Input to Output Isolation	-	$V_{I/O}$	3750	-	-	V_{RMS}

LCB126 Pinout

AC/DC Configuration

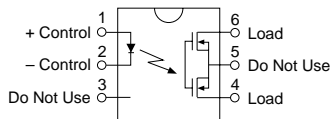

LCB126 Pinout

DC Only Configuration

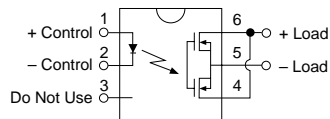

Note: For Mechanical Dimensions See Pages 396-401

www.cpcclare.com

PERFORMANCE DATA

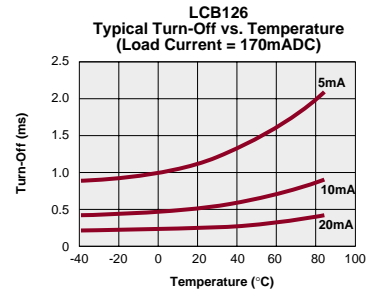
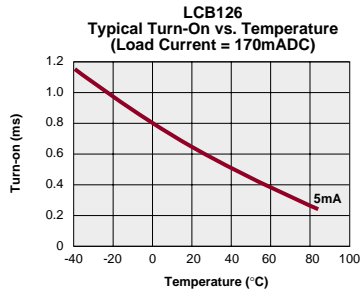
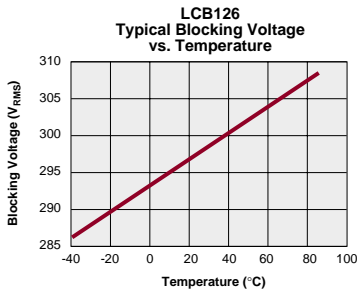
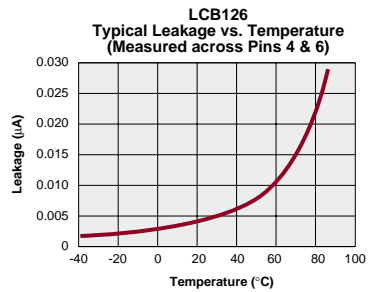
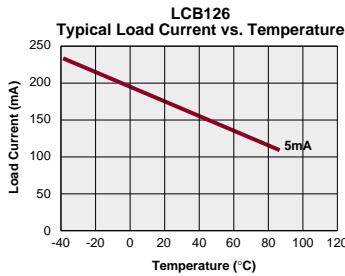
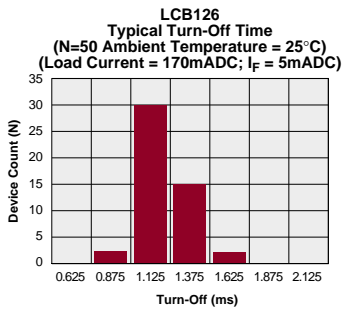
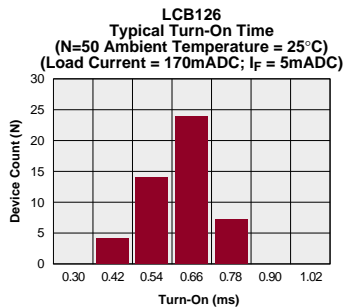
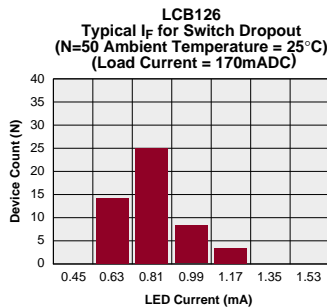
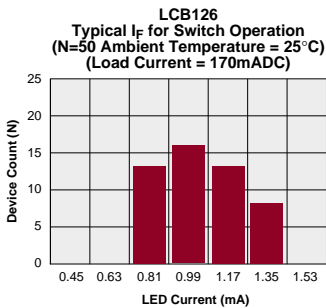
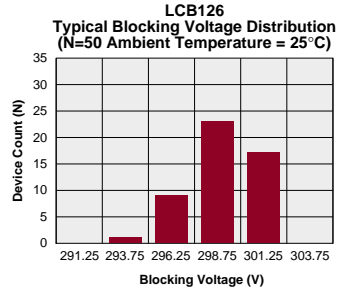
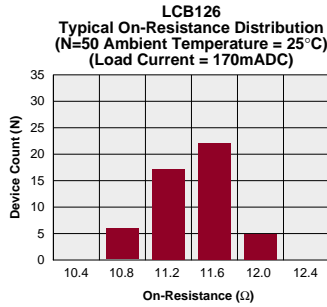
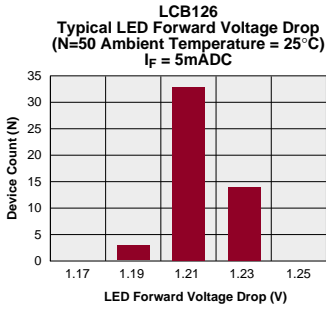

PERFORMANCE DATA

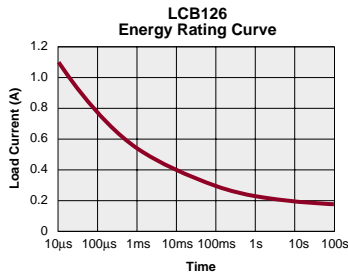
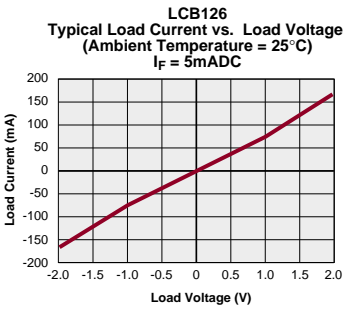
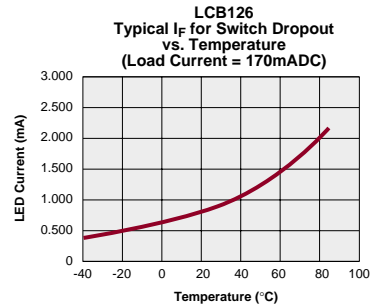
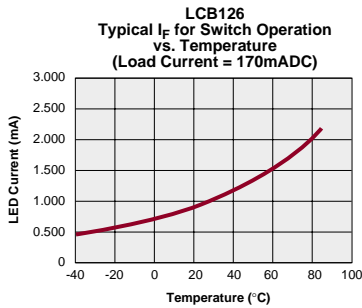
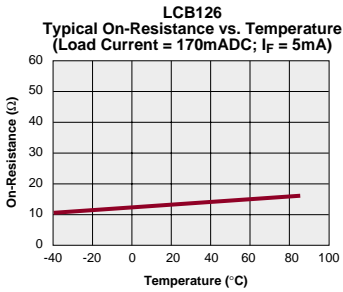
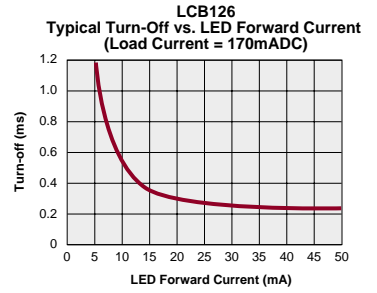
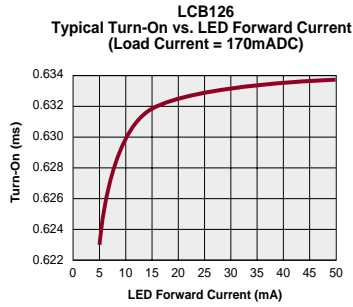
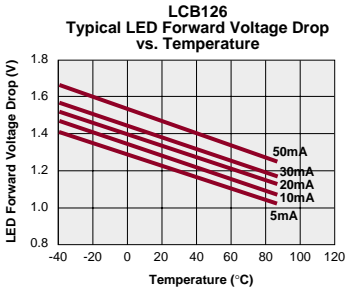

LCB127



DESCRIPTION

The LCB127 is a 250V, 200mA, 10Ω type 1-Form-B solid state relay.

FEATURES

- Small 6 Pin DIP Package
- Low Drive Power Requirements (TTL/CMOS Compatible)
- No Moving Parts
- High Reliability
- Arc-Free With No Snubbing Circuits
- 3750V_{RMS} Input/Output Isolation
- FCC Compatible
- VDE Compatible
- No EMI/RFI Generation
- Machine Insertable, Wave Solderable
- Current Limiting Surface Mount and Tape & Reel Versions Available

APPROVALS

- UL Recognized: File Number E76270
- CSA Certified: File Number LR 43639-10
- BSI Certified to:
 - BS EN 60950:1992 (BS7002:1992)
Certificate #: 7344
 - BS EN 41003:1993
Certificate #: 7344

OPTIONS / SUFFIXES

- S: Surface Mount Package
- TR: Tape & Reel

Switching Characteristics of Normally Closed (Form B) Devices

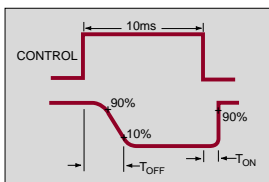

APPLICATIONS

- Telecommunications
 - Telecom Switching
 - Tip/Ring Circuits
 - Modem Switching (Laptop, Notebook, Pocket Size)
 - Hookswitch
 - Dial Pulsing
 - Ground Start
 - Ringer Injection
- Instrumentation
 - Multiplexers
 - Data Acquisition
 - Electronic Switching
 - I/O Subsystems
 - Meters (Watt-Hour, Water, Gas)
- Medical Equipment-Patient/Equipment Isolation
- Security
- Aerospace
- Industrial Controls

RATINGS (@ 25°C)

Parameter	Min	Typ	Max	Units
Input Power Dissipation	-	-	150 ¹	mW
Input Control Current	-	-	50	mA
Peak (10ms)	-	-	1	A
Reverse Input Voltage	-	-	5	V
Total Power Dissipation	-	-	800 ²	mW
Capacitance				
Input to Output	-	3	-	pF
Isolation Voltage				
Input to Output	3750	-	-	V _{RMS}
Operational Temperature	-40	-	+85	°C
Storage Temperature	-40	-	+125	°C
Soldering Temperature (10 Seconds Max.)				
DIP Package	-	-	+260	°C
Surface Mount Package	-	-	+220	°C

¹ Derate Linearly 1.33 mw/°C

² Derate Linearly 1.67 mw/°C

Note: For Mechanical Dimensions See Pages 396-401

SPECIFICATIONS

PARAMETERS	CONDITIONS	SYMBOL	MIN	TYP	MAX	UNITS
Output Characteristics @ 25°C						
Load Voltage (Peak)	-	V_L	-	-	250	V
Load Current (Continuous)	-	I_L	-	-	200	mA
AC/DC Configuration	-	I_L	-	-	200	mA
DC Configuration	-	I_L	-	-	300	mA
Peak Load Current	10ms	I_L	-	-	400	mA
On-Resistance	-	R_{ON}	-	-	-	Ω
AC/DC Configuration	$I_L=200mA$	R_{ON}	-	8	10	Ω
DC Configuration	$I_L=300mA$	R_{ON}	-	2	3	Ω
Off-State Leakage Current	$V_L=250V$	I_{LEAK}	-	-	1	μA
Switching Speed	-	T_{ON}	-	-	5	ms
Turn-On	$I_F=5mA, V_L=10V$	T_{ON}	-	-	5	ms
Turn-Off	$I_F=5mA, V_L=10V$	T_{OFF}	-	-	5	ms
Output Capacitance	50V; f=1MHz	C_{OUT}	-	50	-	pF
Input Characteristics @ 25°C						
Input Control Current	$I_L=200mA$	I_F	5	-	50	mA
Input Dropout Current	-	I_F	0.4	0.7	-	mA
Input Voltage Drop	$I_F=5mA$	V_F	0.9	1.2	1.4	V
Reverse Input Voltage	-	V_R	-	-	5	V
Reverse Input Current	$V_R=5V$	I_R	-	-	10	μA
Input to Output Capacitance	-	$C_{I/O}$	-	3	-	pF
Input to Output Isolation	-	$V_{I/O}$	3750	-	-	V_{RMS}

LCB127 Pinout

AC/DC Configuration

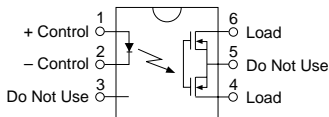

LCB127 Pinout

DC Only Configuration

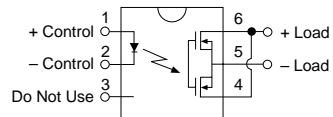

Note: For Mechanical Dimensions See Pages 396-401

www.cpclare.com

LCB127

PERFORMANCE DATA

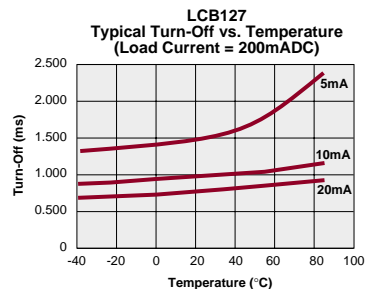
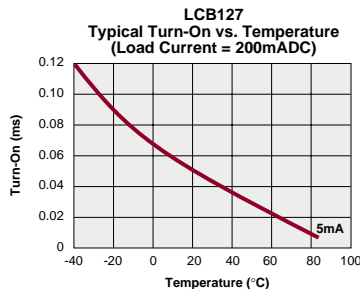
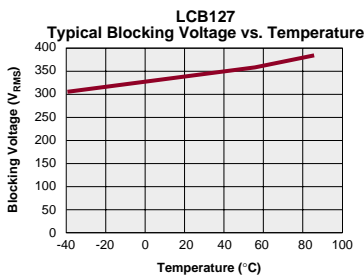
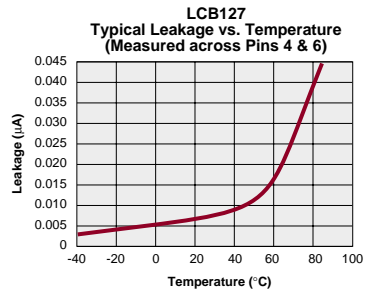
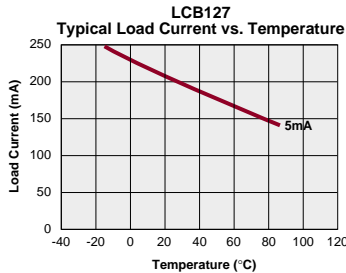
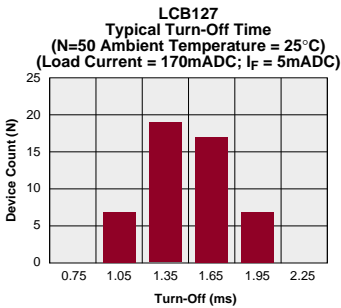
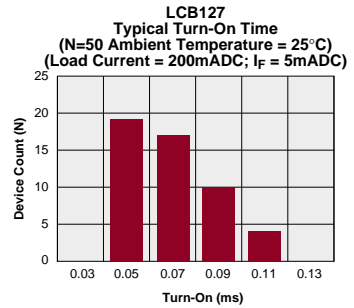
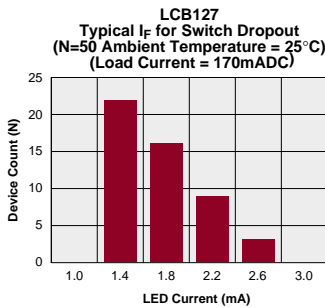
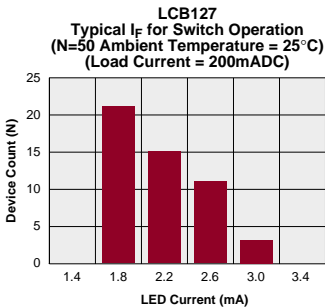
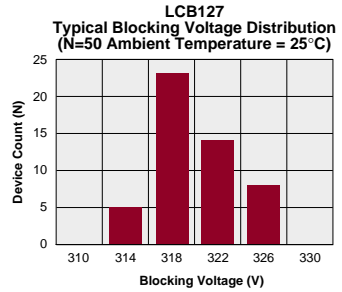
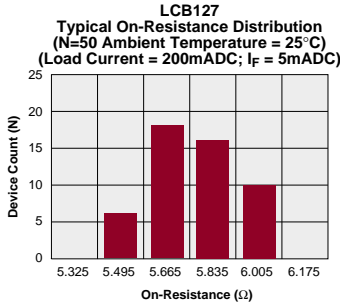
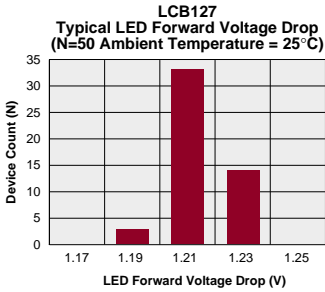

PERFORMANCE DATA

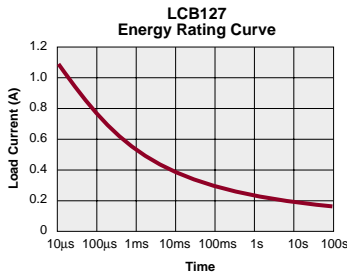
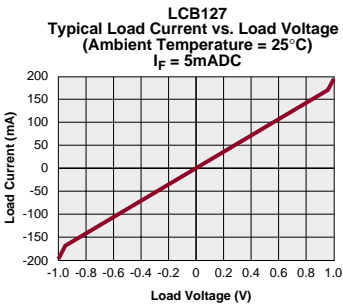
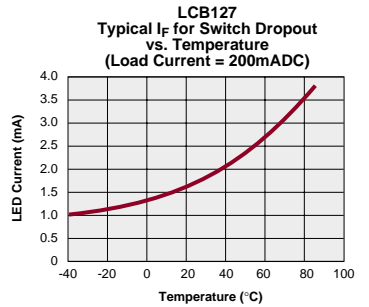
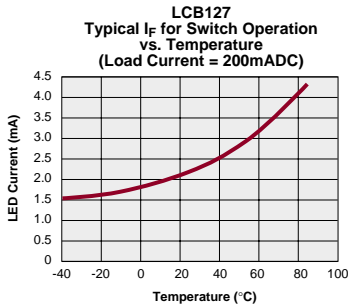
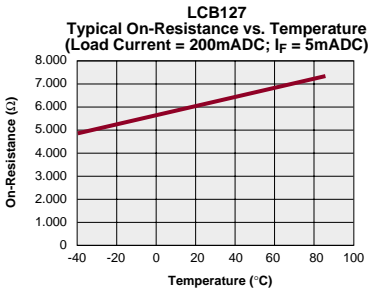
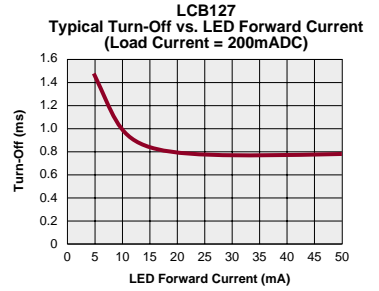
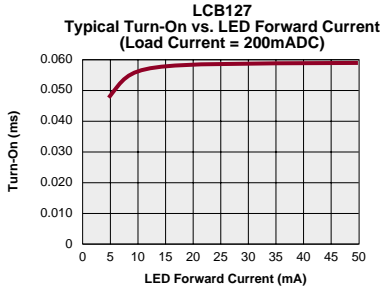
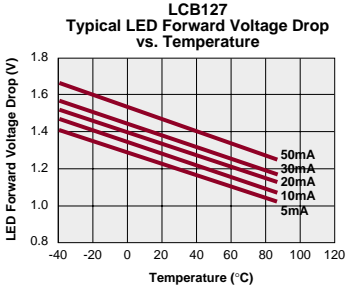

OMA160



DESCRIPTION

The OMA160 is a 250V, 50mA, 100Ω type 1-Form-A solid state relay.

FEATURES

- Small 6 Pin DIP Package
- Low Drive Power Requirements (TTL/CMOS Compatible)
- No Moving Parts
- High Reliability
- Arc-Free With No Snubbing Circuits
- 3750V_{RMS} Input/Output Isolation
- FCC Compatible
- VDE Compatible
- No EMI/RFI Generation
- Machine Insertable, Wave Solderable
- Current Limiting, Surface Mount and Tape & Reel Versions Available

APPROVALS

- UL Recognized: File Number E76270
- CSA Certified: File Number LR 43639-10
- BSI Certified:
 - BS EN 60950:1992 (BS7002:1992) Certificate #:7344
 - BS EN 41003:1993 Certificate #:7344

OPTIONS / SUFFIXES

- S: Surface Mount Package
- TR: Tape & Reel

Switching Characteristics of Normally Open (Form A) Devices

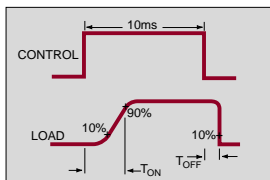

APPLICATIONS

- Telecommunications
 - Telecom Switching
 - Tip/Ring Circuits
 - Modem Switching (Laptop, Notebook, Pocket Size)
 - Hookswitch
 - Dial Pulsing
 - Ground Start
 - Ringer Injection
- Instrumentation
 - Multiplexers
 - Data Acquisition
 - Electronic Switching
 - I/O Subsystems
 - Meters (Watt-Hour, Water, Gas)
- Medical Equipment-Patient/Equipment Isolation
- Security
- Aerospace
- Industrial Controls

RATINGS (@ 25° C)

Parameter	Min	Typ	Max	Units
Input Power Dissipation	-	-	150 ¹	mW
Input Control Current	-	-	50	mA
Peak (10ms)	-	-	1	A
Reverse Input Voltage	-	-	5	V
Total Power Dissipation	-	-	800 ²	mW
Capacitance				
Input to Output	-	3	-	pF
Isolation Voltage				
Input to Output	3750	-	-	V _{RMS}
Operational Temperature	-40	-	+85	°C
Storage Temperature	-40	-	+125	°C
Soldering Temperature (10 Seconds Max.)				
DIP Package	-	-	+260	°C
Surface Mount Package	-	-	+220	°C

¹ Derate Linearly 1.33 mw/°C

² Derate Linearly 1.67 mw/°C

Note: For Mechanical Dimensions See Pages 396-401

SPECIFICATIONS

PARAMETERS	CONDITIONS	SYMBOL	MIN	TYP	MAX	UNITS
Output Characteristics @ 25° C						
Load Voltage (Peak)	-	V_L	-	-	250	V
Load Current (Continuous)	-	I_L	-	-	50	mA
AC/DC Configuration	-	I_L	-	-	80	mA
DC Configuration	-	I_L	-	-	100	mA
Peak Load Current	10ms	I_{LPK}	-	-	100	mA
On-Resistance	-	R_{ON}	-	-	100	Ω
AC/DC Configuration	$I_L=50mA$	R_{ON}	-	50	100	Ω
DC Configuration	$I_L=80mA$	R_{ON}	-	15	30	Ω
Off-State Leakage Current	$V_L=250V$	I_{LEAK}	-	-	25	nA
Switching Speeds	-	-	-	-	-	-
Turn-On	$I_F=10mA, V_L=10V$	T_{ON}	-	-	0.125	ms
Turn-Off	$I_F=10mA, V_L=10V$	T_{OFF}	-	-	0.125	ms
Output Capacitance	50V, f=1MHz	C_{OUT}	-	5	-	pF
Input Characteristics @ 25° C						
Input Control Current	$I_L=50mA$	I_F	10	-	50	mA
Input Dropout Current	-	I_F	0.4	0.7	-	mA
Input Voltage Drop	$I_F=10mA$	V_F	0.9	1.2	1.4	V
Reverse Input Voltage	-	V_R	-	-	5	V
Reverse Input Current	$V_R=5V$	I_R	-	-	10	μA
Input to Output Capacitance	-	$C_{I/O}$	-	3	-	pF
Input to Output Isolation	-	$V_{I/O}$	3750	-	-	V_{RMS}

OMA160 Pinout

AC/DC Configuration

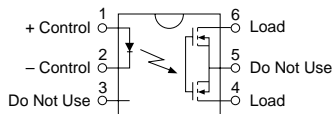

OMA160 Pinout

DC Only Configuration

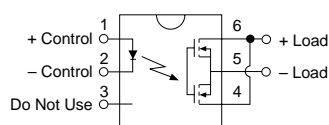

Note: For Mechanical Dimensions See Pages 396-401

www.cpcclare.com

OMA160

PERFORMANCE DATA

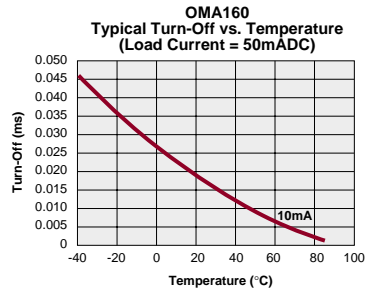
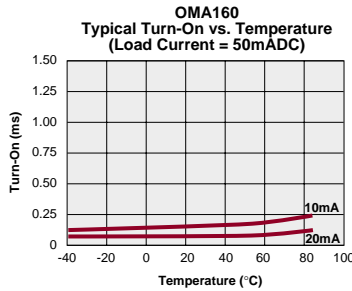
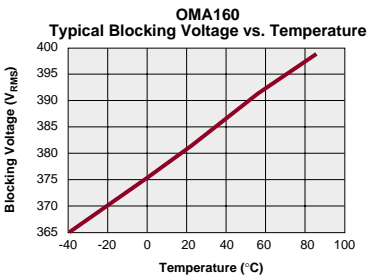
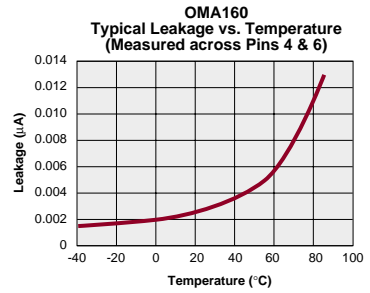
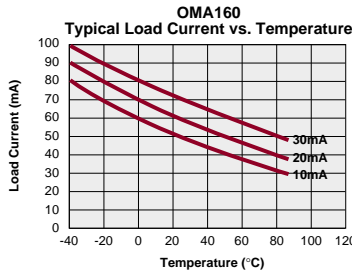
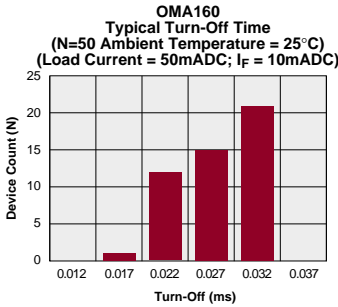
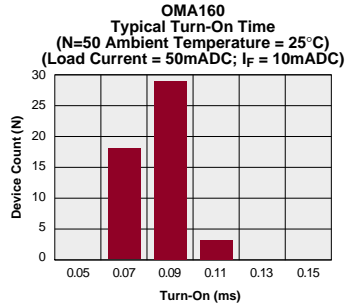
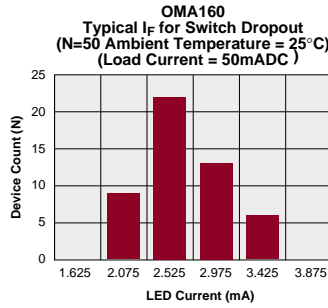
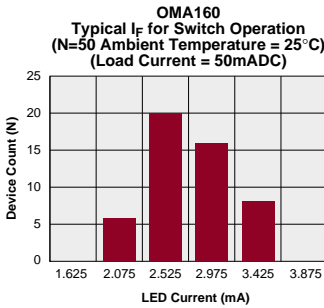
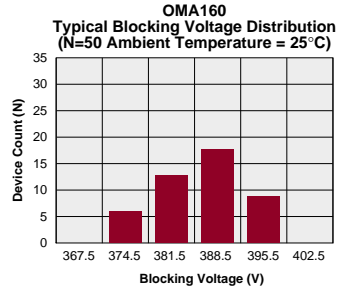
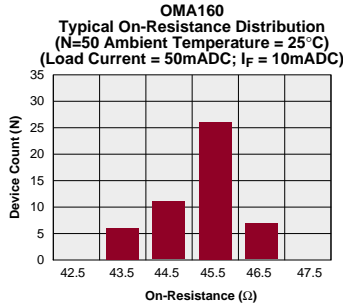
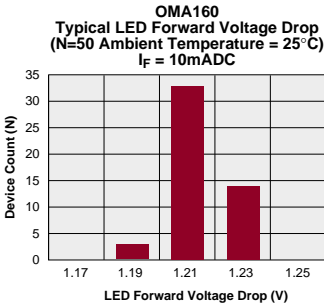

PERFORMANCE DATA

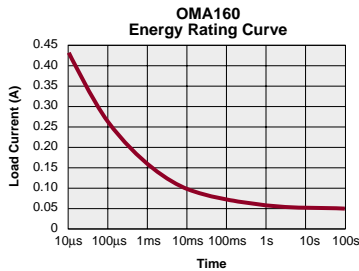
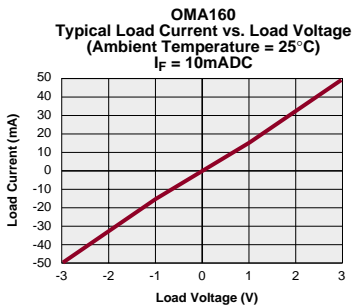
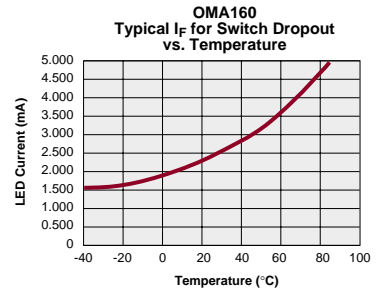
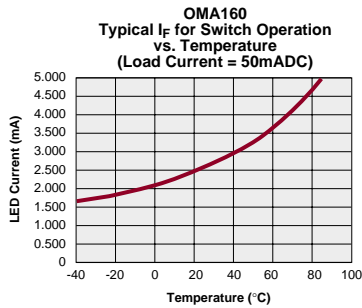
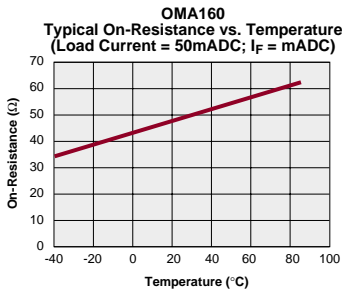
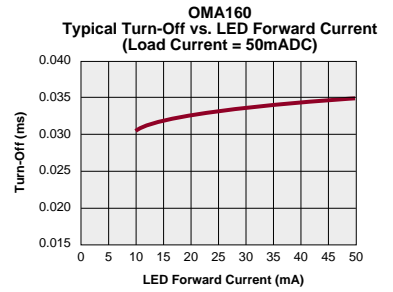
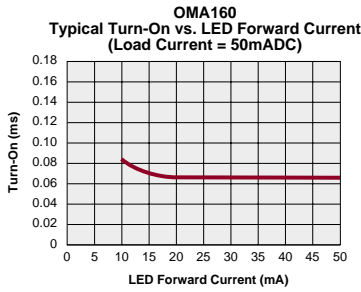
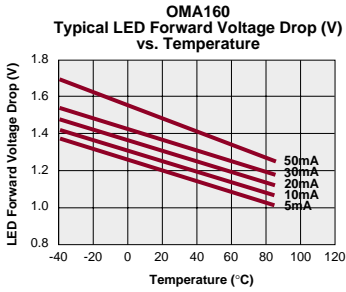

PLA110/PLA110L



DESCRIPTION

The PLA110 is a 400V, 150mA, 22Ω type 1-Form-A solid state relay. Current limiting version available ("L" suffix).

FEATURES

- Small 6 Pin DIP Package
- Low Drive Power Requirements (TTL/CMOS Compatible)
- No Moving Parts
- High Reliability
- Arc-Free With No Snubbing Circuits
- 3750V_{RMS} Input/Output Isolation
- FCC Compatible
- VDE Compatible
- No EMI/RFI Generation
- Machine Insertable, Wave Solderable
- Current Limiting, Surface Mount and Tape & Reel Versions Available

APPROVALS

- UL Recognized: File Number E76270
- CSA Certified: File Number LR 43639-10
- BSI Certified:
 - BS EN 60950:1992 (BS7002:1992) Certificate #:7344
 - BS EN 41003:1993 Certificate #:7344

OPTIONS / SUFFIXES

- L: Current Limiting
- S: Surface Mount Package
- TR: Tape & Reel

Switching Characteristics of Normally Open (Form A) Devices

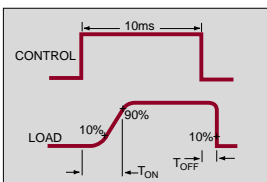

APPLICATIONS

- Telecommunications
 - Telecom Switching
 - Tip/Ring Circuits
 - Modem Switching (Laptop, Notebook, Pocket Size)
 - Hookswitch
 - Dial Pulsing
 - Ground Start
 - Ringer Injection
- Instrumentation
 - Multiplexers
 - Data Acquisition
 - Electronic Switching
 - I/O Subsystems
 - Meters (Watt-Hour, Water, Gas)
- Medical Equipment-Patient/Equipment Isolation
- Security
- Aerospace
- Industrial Controls

RATINGS (@ 25° C)

Parameter	Min	Typ	Max	Units
Input Power Dissipation	-	-	150 ¹	mW
Input Control Current	-	-	50	mA
Peak (10ms)	-	-	1	A
Reverse Input Voltage	-	-	5	V
Total Power Dissipation	-	-	800 ²	mW
Capacitance				
Input to Output	-	3	-	pF
Isolation Voltage				
Input to Output	3750	-	-	V _{RMS}
Operational Temperature	-40	-	+85	°C
Storage Temperature	-40	-	+125	°C
Soldering Temperature (10 Seconds Max.)				
DIP Package	-	-	+260	°C
Surface Mount Package	-	-	+220	°C

¹ Derate Linearly 1.33 mW/°C

² Derate Linearly 1.67 mW/°C

Note: For Mechanical Dimensions See Pages 396-401

SPECIFICATIONS

PARAMETERS	CONDITIONS	SYMBOL	PLA110			PLA110L			UNITS
			MIN	TYP	MAX	MIN	TYP	MAX	
Output Characteristics @ 25°C									
Load Voltage (Peak)	-	V_L	-	-	400	-	-	400	V
Load Current (Continuous)	-	I_L	-	-	150	-	-	150	mA
AC/DC Configuration	-	I_L	-	-	250	-	-	250	mA
DC Configuration	-	I_L	-	-	250	-	-	250	mA
Peak Load Current	10ms	I_L	-	-	400	-	-	-	mA
On-Resistance	-	R_{ON}	-	-	-	-	-	-	Ω
AC/DC Configuration	$I_L=150mA$	R_{ON}	-	15	22	-	18	25	Ω
DC Configuration	$I_L=250mA$	R_{ON}	-	5	7	-	7	9	Ω
Off-State Leakage Current	$V_L=400V$	I_{LEAK}	-	-	1	-	-	-	μA
Switching Speeds	-	-	-	-	-	-	-	-	-
Turn-On	$I_F=5mA, V_L=10V$	T_{ON}	-	-	1	-	-	1	ms
Turn-Off	$I_F=5mA, V_L=10V$	T_{OFF}	-	-	0.25	-	-	0.25	ms
Output Capacitance	50V; f=1MHz	C_{OUT}	-	25	-	-	25	-	pF
Load Current Limiting	-	I_{CL}	-	-	-	190	235	280	mA
Input Characteristics @ 25°C									
Input Control Current	$I_L=150mA$	I_F	5	-	50	5	-	50	mA
Input Dropout Current	-	I_F	0.4	0.7	-	0.4	0.7	-	mA
Input Voltage Drop	$I_F=5mA$	V_F	0.9	1.2	1.4	0.9	1.2	1.4	V
Reverse Input Voltage	-	V_R	-	-	5	-	-	5	V
Reverse Input Current	$V_R=5V$	I_R	-	-	10	-	-	10	μA
Input to Output Capacitance	-	$C_{I/O}$	-	3	-	-	3	-	pF
Input to Output Isolation	-	$V_{I/O}$	3750	-	-	3750	-	-	V_{RMS}

PLA110/PLA110L Pinout

AC/DC Configuration

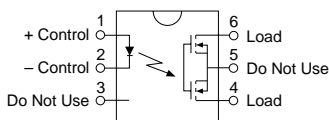

PLA110/PLA110L Pinout

DC Only Configuration

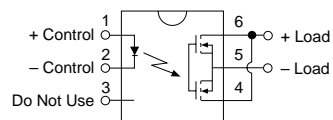

Note: For Mechanical Dimensions See Pages 396-401

www.cpcclare.com

PLA110/PLA110L

PERFORMANCE DATA

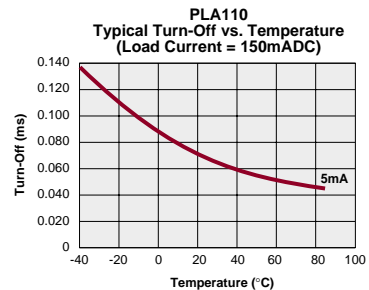
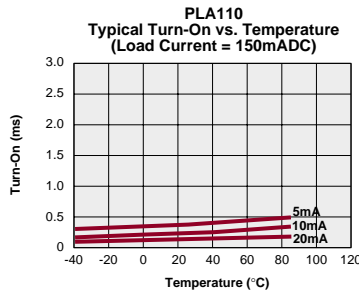
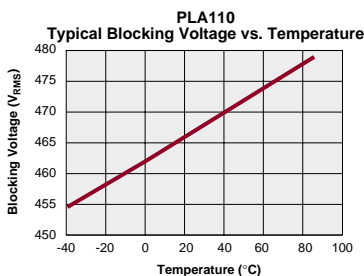
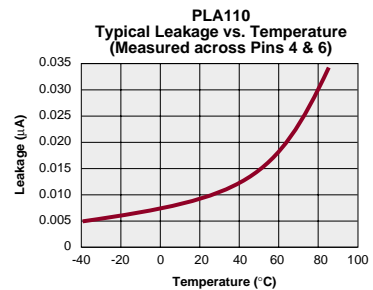
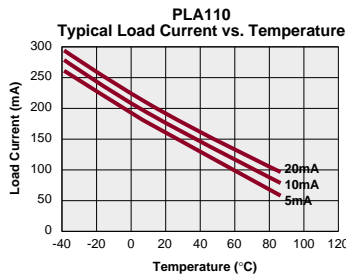
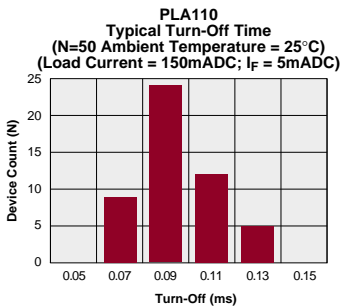
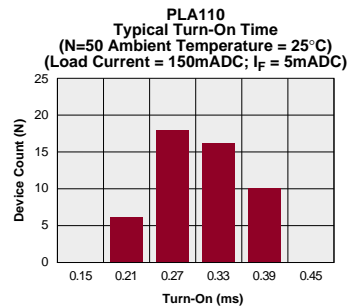
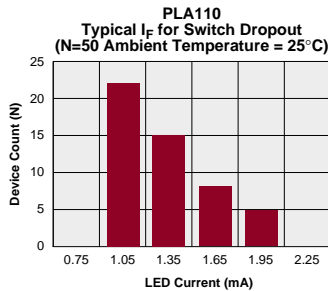
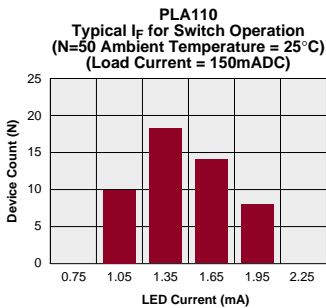
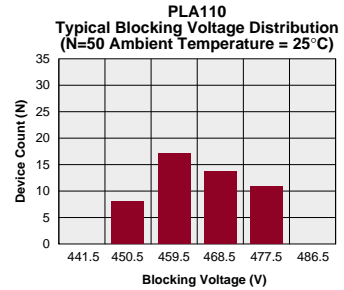
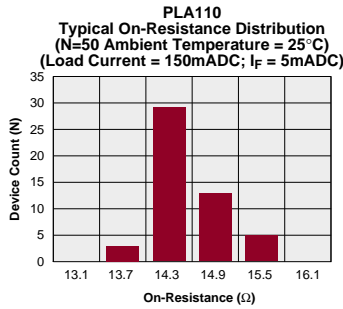
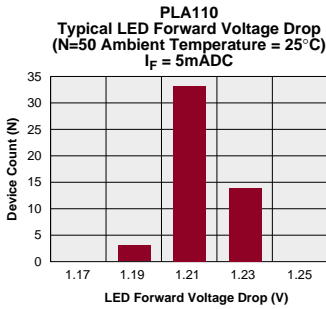

PERFORMANCE DATA

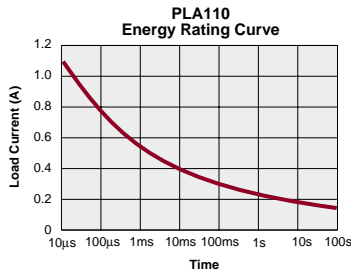
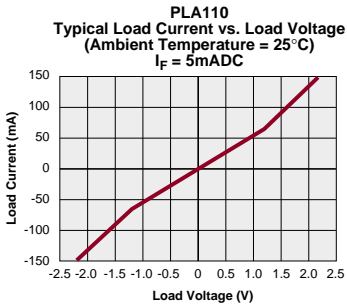
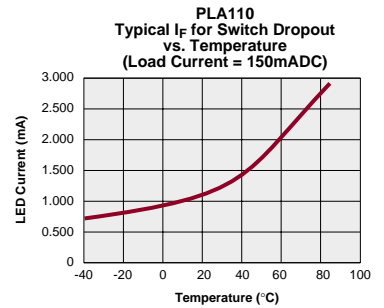
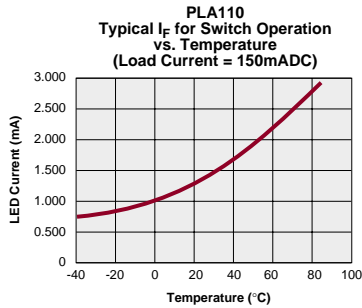
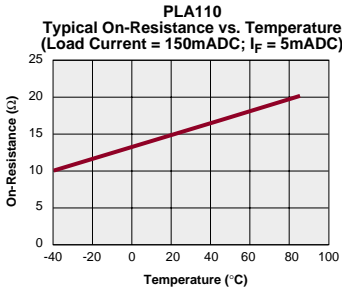
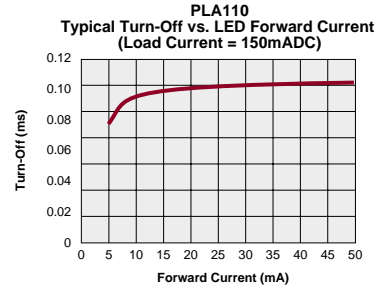
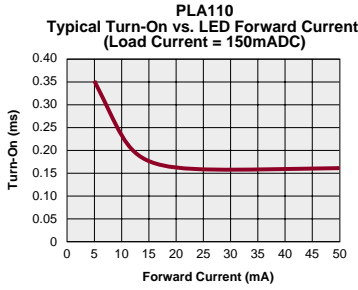
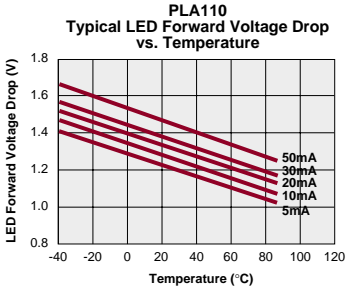

PLA110/PLA110L

PERFORMANCE DATA

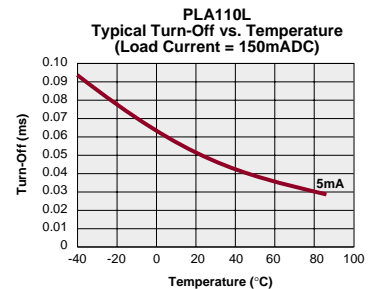
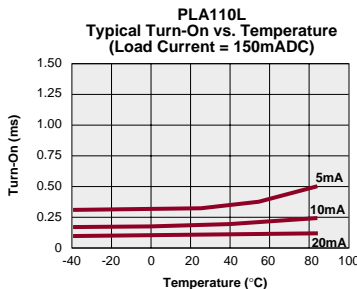
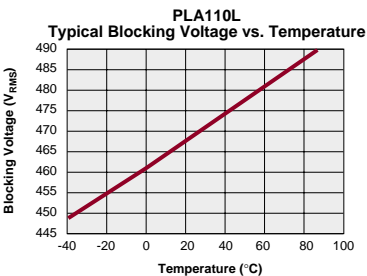
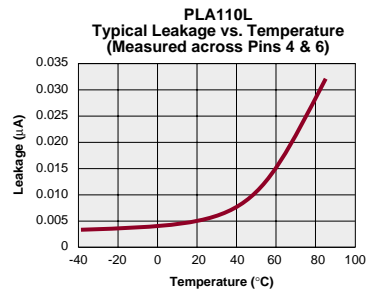
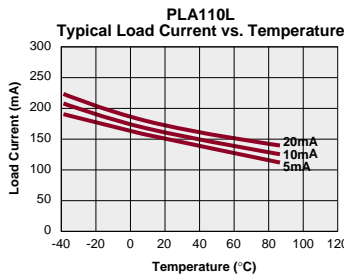
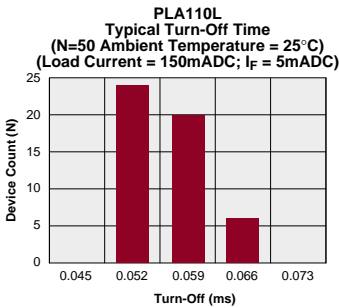
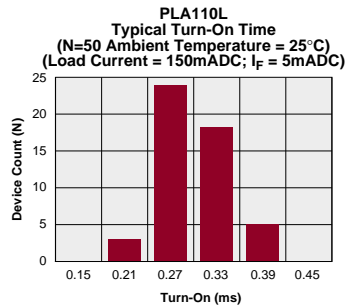
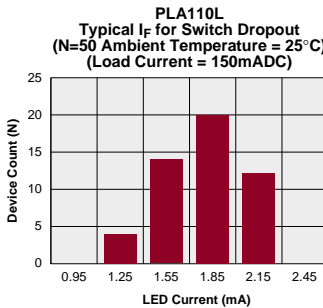
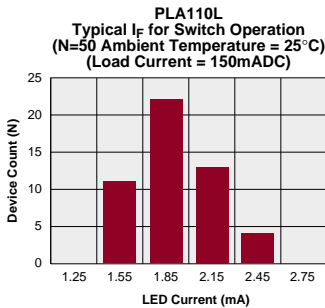
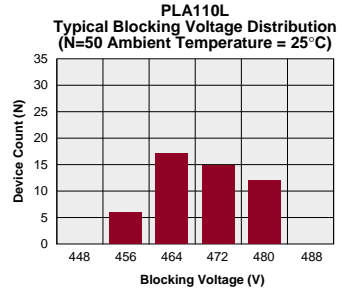
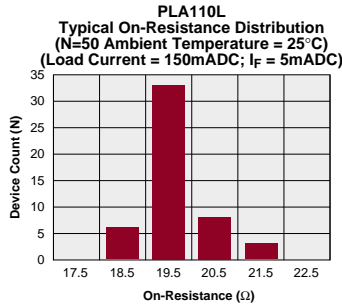
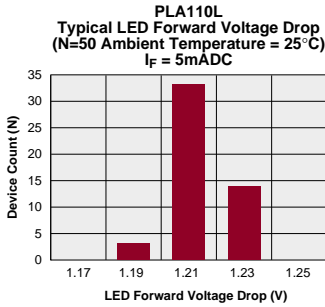

PERFORMANCE DATA

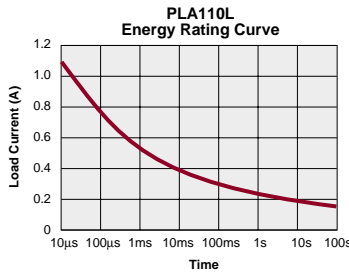
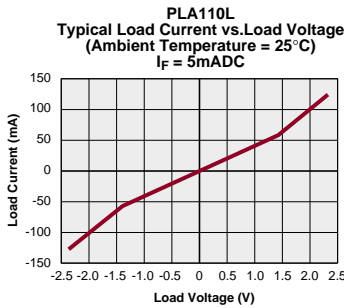
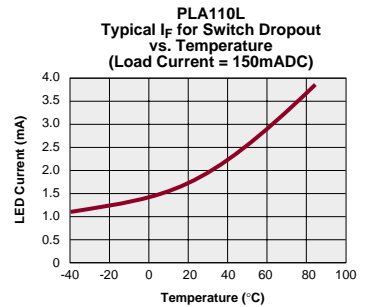
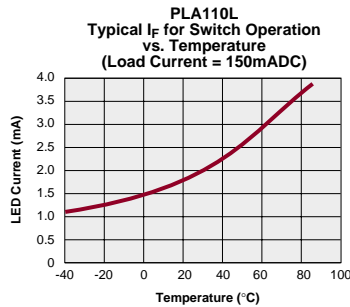
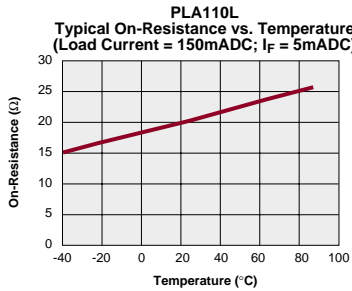
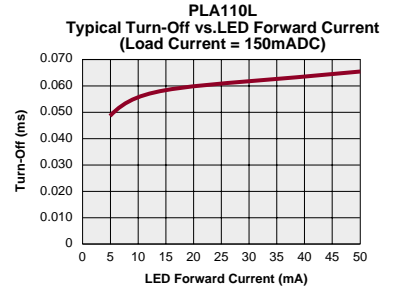
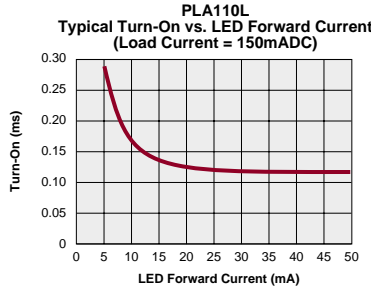
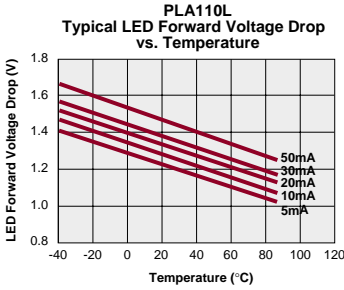

PLA140



DESCRIPTION

The PLA140 is a 400V, 250mA, 8Ω type 1-Form-A solid state relay.

FEATURES

- Small 6 Pin DIP Package
- Low Drive Power Requirements (TTL/CMOS Compatible)
- No Moving Parts
- High Reliability
- Arc-Free With No Snubbing Circuits
- 3750V_{RMS} Input/Output Isolation
- FCC Compatible
- VDE Compatible
- No EMI/RFI Generation
- Machine Insertable, Wave Solderable
- Current Limiting, Surface Mount and Tape & Reel Versions Available

APPROVALS

- UL Recognized: File Number E76270
- CSA Certified: File Number LR 43639-10
- BSI Certified:
 - BS EN 60950:1992 (BS7002:1992) Certificate #:7344
 - BS EN 41003:1993 Certificate #:7344

OPTIONS / SUFFIXES

- S: Surface Mount Package
- TR: Tape & Reel

Switching Characteristics of Normally Open (Form A) Devices

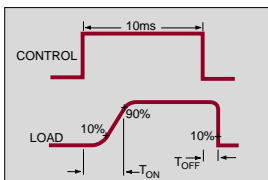

APPLICATIONS

- Telecommunications
 - Telecom Switching
 - Tip/Ring Circuits
 - Modem Switching (Laptop, Notebook, Pocket Size)
 - Hookswitch
 - Dial Pulsing
 - Ground Start
 - Ringer Injection
- Instrumentation
 - Multiplexers
 - Data Acquisition
 - Electronic Switching
 - I/O Subsystems
 - Meters (Watt-Hour, Water, Gas)
- Medical Equipment-Patient/Equipment Isolation
- Security
- Aerospace
- Industrial Controls

RATINGS (@ 25° C)

Parameter	Min	Typ	Max	Units
Input Power Dissipation	-	-	150 ¹	mW
Input Control Current	-	-	50	mA
Peak (10ms)	-	-	1	A
Reverse Input Voltage	-	-	5	V
Total Power Dissipation	-	-	800 ²	mW
Capacitance				
Input to Output	-	3	-	pF
Isolation Voltage				
Input to Output	3750	-	-	V _{RMS}
Operational Temperature	-40	-	+85	°C
Storage Temperature	-40	-	+125	°C
Soldering Temperature				
(10 Seconds Max.)				
DIP Package	-	-	+260	°C
Surface Mount Package	-	-	+220	°C

¹ Derate Linearly 1.33 mw/°C

² Derate Linearly 1.67 mw/°C

Note: For Mechanical Dimensions See Pages 396-401

SPECIFICATIONS

PARAMETERS	CONDITIONS	SYMBOL	MIN	TYP	MAX	UNITS
Output Characteristics @ 25°C						
Load Voltage (Peak)	-	V_L	-	-	400	V
Load Current (Continuous)	-	I_L	-	-	250	mA
AC/DC Configuration	-	I_L	-	-	250	mA
DC Configuration	-	I_L	-	-	350	mA
Peak Load Current	10ms	I_L	-	-	500	mA
On-Resistance	-	R_{ON}	-	-	8	Ω
AC/DC Configuration	$I_L=250mA$	R_{ON}	-	6	8	Ω
DC Configuration	$I_L=350mA$	R_{ON}	-	2	3	Ω
Off-State Leakage Current	$V_L=400V$	I_{LEAK}	-	-	1	μA
Switching Speeds	-	-	-	-	-	-
Turn-On	$I_F=5mA, V_L=10V$	T_{ON}	-	-	1.5	ms
Turn-Off	$I_F=5mA, V_L=10V$	T_{OFF}	-	-	0.25	ms
Output Capacitance	50V; f=1MHz	C_{OUT}	-	65	-	pF
Input Characteristics @ 25°C						
Input Control Current	$I_L=250mA$	I_F	5	-	50	mA
Input Dropout Current	-	I_F	0.4	0.7	-	mA
Input Voltage Drop	$I_F=5mA$	V_F	0.9	1.2	1.4	V
Reverse Input Voltage	-	V_R	-	-	5	V
Reverse Input Current	$V_R=5V$	I_R	-	-	10	μA
Input to Output Capacitance	-	$C_{I/O}$	-	3	-	pF
Input to Output Isolation	-	$V_{I/O}$	3750	-	-	V_{RMS}

PLA140 Pinout

AC/DC Configuration

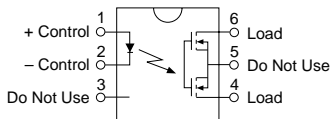

PLA140 Pinout

DC Only Configuration

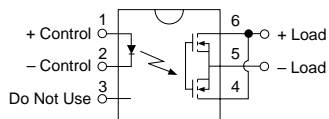

Note: For Mechanical Dimensions See Pages 396-401

www.cpcclare.com

PLA140

PERFORMANCE DATA

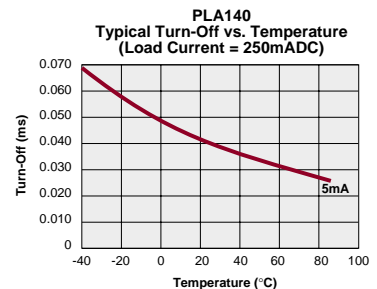
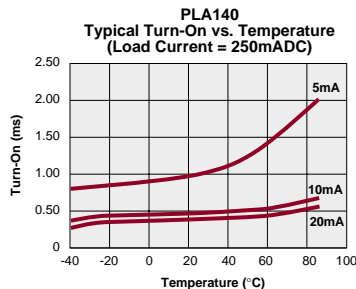
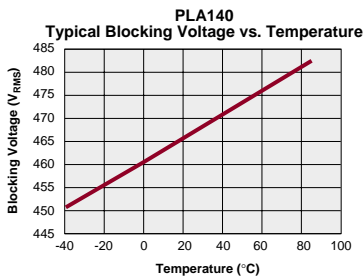
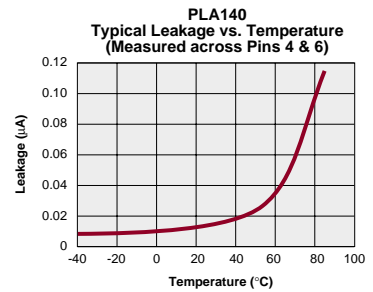
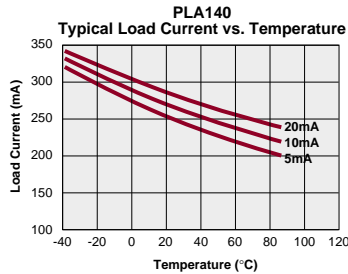
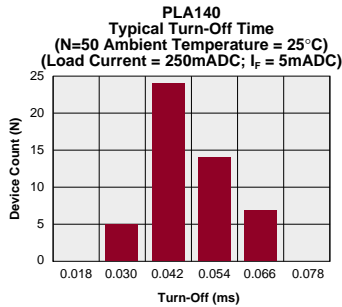
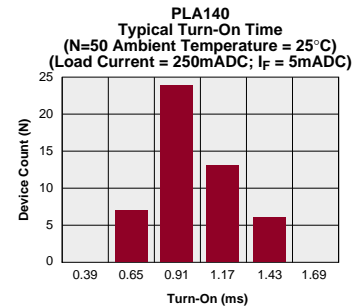
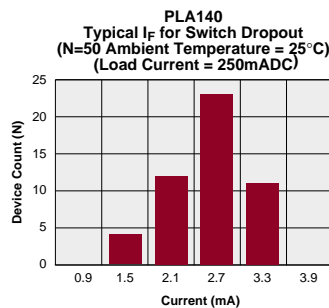
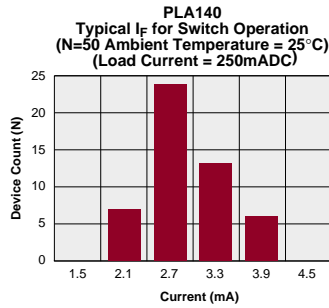
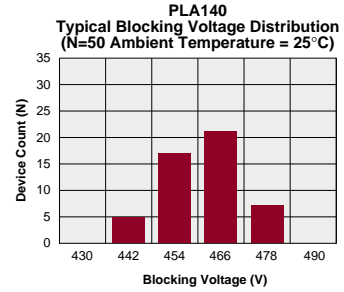
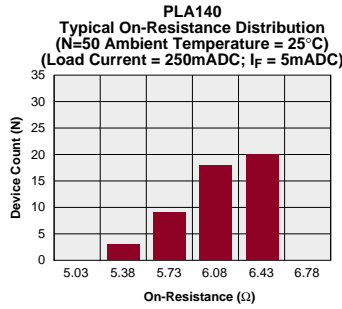
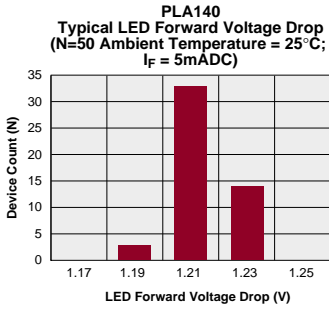

PERFORMANCE DATA

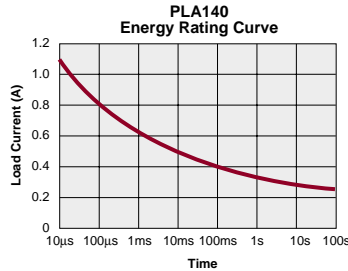
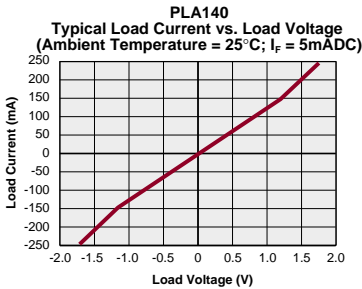
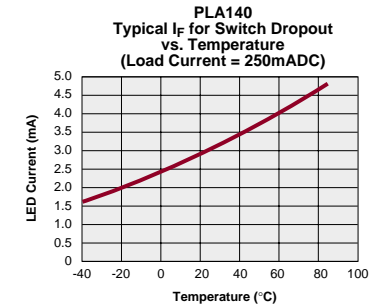
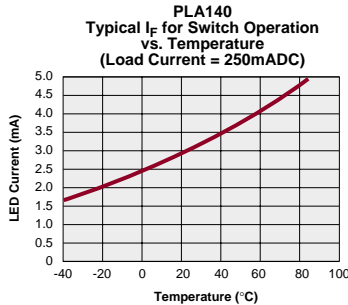
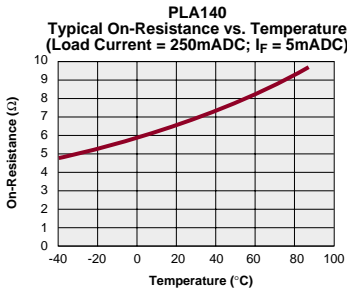
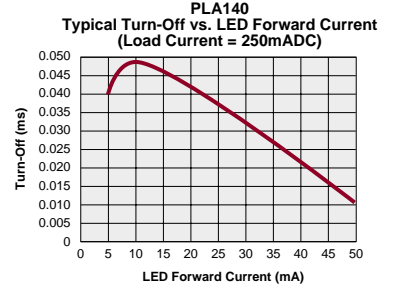
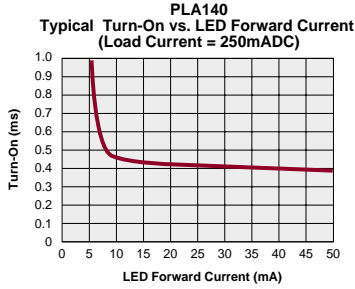
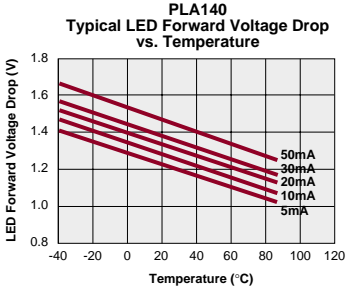

PLA160



DESCRIPTION

The PLA160 is a 300V, 50mA, 100Ω type 1-Form-A solid state relay. Typical turn-on switching speed of 25μs.

FEATURES

- Small 6 Pin DIP Package
- Low Drive Power Requirements (TTL/CMOS Compatible)
- No Moving Parts
- High Reliability
- Arc-Free With No Snubbing Circuits
- 3750V_{RMS} Input/Output Isolation
- FCC Compatible
- VDE Compatible
- No EMI/RFI Generation
- Machine Insertable, Wave Solderable
- Current Limiting, Surface Mount and Tape & Reel Versions Available

APPROVALS

- UL Recognized: File Number E76270
- CSA Certified: File Number LR 43639-10
- BSI Certified:
 - BS EN 60950:1992 (BS7002:1992) Certificate #:7344
 - BS EN 41003:1993 Certificate #:7344

OPTIONS / SUFFIXES

- S: Surface Mount Package
- TR: Tape & Reel

Switching Characteristics of Normally Open (Form A) Devices

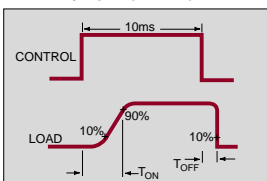

APPLICATIONS

- Telecommunications
 - Telecom Switching
 - Tip/Ring Circuits
 - Modem Switching (Laptop, Notebook, Pocket Size)
 - Hookswitch
 - Dial Pulsing
 - Ground Start
 - Ringer Injection
- Instrumentation
 - Multiplexers
 - Data Acquisition
 - Electronic Switching
 - I/O Subsystems
 - Meters (Watt-Hour, Water, Gas)
- Medical Equipment-Patient/Equipment Isolation
- Security
- Aerospace
- Industrial Controls

RATINGS (@ 25°C)

Parameter	Min	Typ	Max	Units
Input Power Dissipation	-	-	150 ¹	mW
Input Control Current	-	-	50	mA
Peak (10ms)	-	-	1	A
Reverse Input Voltage	-	-	5	V
Total Power Dissipation	-	-	800 ²	mW
Capacitance				
Input to Output	-	3	-	pF
Isolation Voltage				
Input to Output	3750	-	-	V _{RMS}
Operational Temperature	-40	-	+85	°C
Storage Temperature	-40	-	+125	°C
Soldering Temperature (10 Seconds Max.)				
DIP Package	-	-	+260	°C
Surface Mount Package	-	-	+220	°C

¹ Derate Linearly 1.33 mw/°C

² Derate Linearly 1.67 mw/°C

Note: For Mechanical Dimensions See Pages 396-401

SPECIFICATIONS

PARAMETERS	CONDITIONS	SYMBOL	MIN	TYP	MAX	UNITS
Output Characteristics @ 25°C						
Load Voltage (Peak)	-	V_L	-	-	300	V
Load Current (Continuous)	-	I_L	-	-	50	mA
AC/DC Configuration	-	I_L	-	-	80	mA
DC Configuration	-	I_L	-	-	80	mA
Peak Load Current	10ms	I_{LPK}	-	-	200	mA
On-Resistance	-	R_{ON}	-	-	-	Ω
AC/DC Configuration	$I_L=50\text{mA}$	R_{ON}	-	60	100	Ω
DC Configuration	$I_L=80\text{mA}$	R_{ON}	-	15	30	Ω
Off-State Leakage Current	$V_L=300\text{V}$	I_{LEAK}	-	-	25	nA
	$V_L=100\text{V}$	I_{LEAK}	-	1	10	nA
Switching Speeds	-	-	-	-	-	-
Turn-On	$I_F=10\text{mA}, V_L=10\text{V}$	T_{ON}	-	25	50	μS
Turn-Off	$I_F=10\text{mA}, V_L=10\text{V}$	T_{OFF}	-	25	50	μS
Output Capacitance	50V; f=1MHz	C_{OUT}	-	3	-	pF
Input Characteristics @ 25°C						
Input Control Current	$I_L=50\text{mA}$	I_F	10	-	50	mA
Input Dropout Current	-	I_F	0.4	0.7	-	mA
Input Voltage Drop	$I_F=10\text{mA}$	V_F	1.8	2.4	2.8	V
Reverse Input Voltage	-	V_R	-	-	5	V
Reverse Input Current	$V_R=5\text{V}$	I_R	-	-	10	μA
Input to Output Capacitance	-	$C_{I/O}$	-	3	-	pF
Input to Output Isolation	-	$V_{I/O}$	3750	-	-	V_{RMS}

PLA160 Pinout

AC/DC Configuration

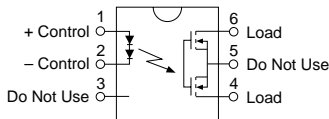

PLA160 Pinout

DC Only Configuration

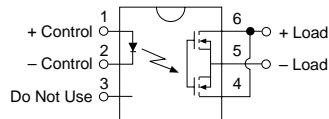

Note: For Mechanical Dimensions See Pages 396-401

www.cpcclare.com

PLA160

PERFORMANCE DATA

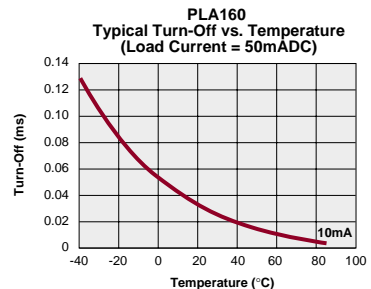
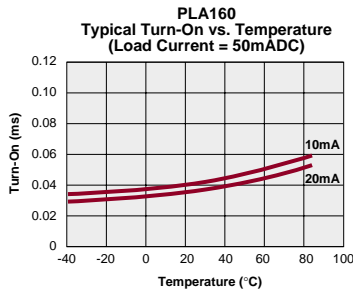
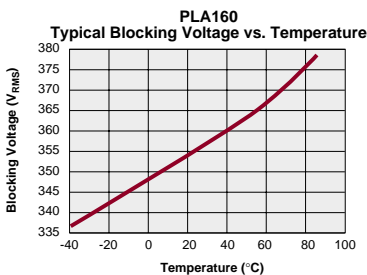
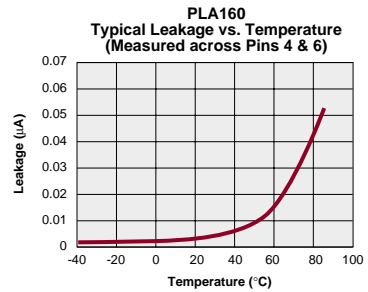
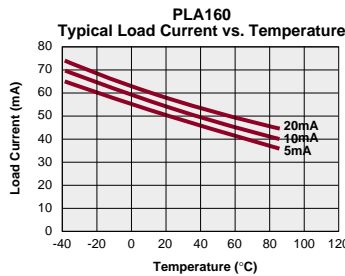
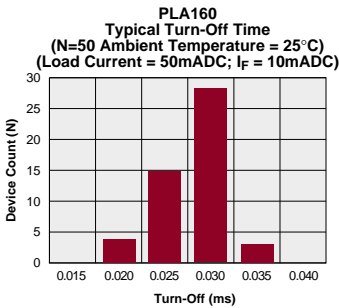
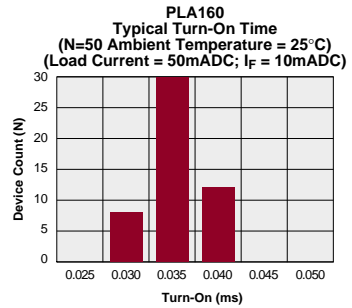
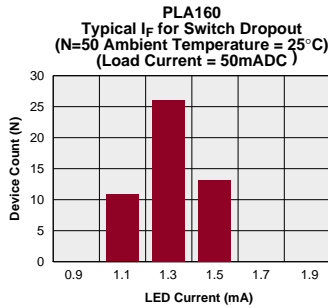
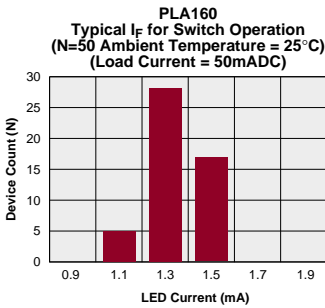
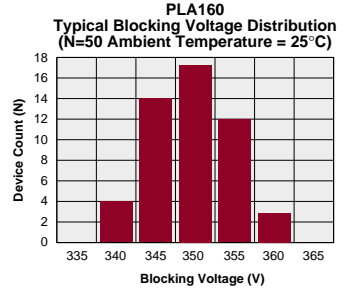
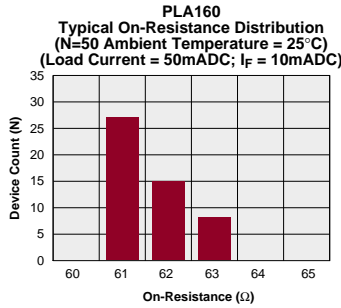
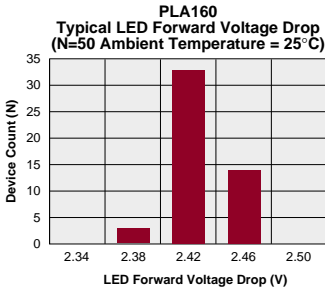

PERFORMANCE DATA

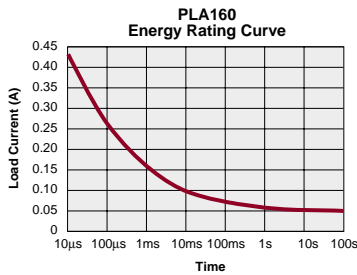
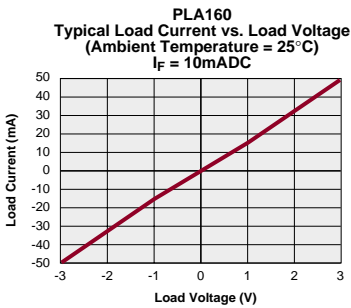
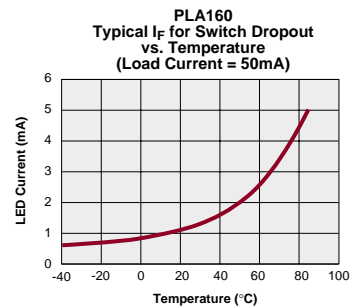
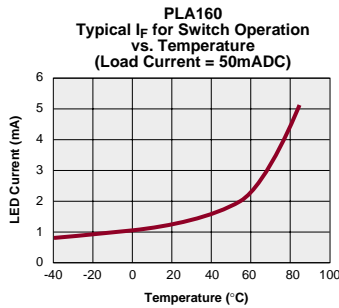
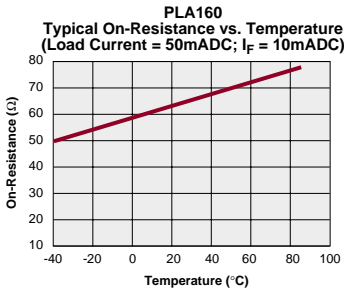
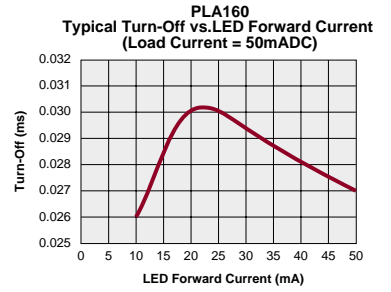
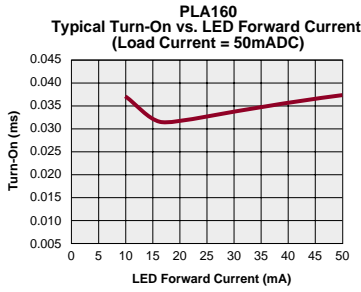
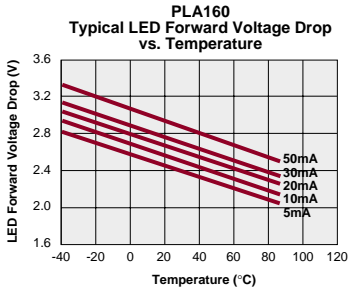

Dual-Pole OptoMOS® Relays



CP Clare's Dual Pole OptoMOS® Relays are an extension of their six pin counterparts. The difference is the dual output offered with this package. By integrating an additional switch in one relay, CP Clare has paved the way for designers to condense more functionality into a single device. The result: more compact design with less board space consumption. Offerings include 2-Form-A, 2-Form-B, independent Form-A/Form-B, and 1-Form-C relays. In addition to being available in the through hole and surface mount packages, the eight pin product is now available in the revolutionary flatpack package. This package type shows CP Clare's commitment to the future as it fulfills the driving needs of PCMCIA design. As with other MOSFET products, fast, reliable switching is assured. Current limiting capabilities are available on certain models.

Dual Pole OptoMOS® Relays

Part Number	LAA110	XAA170	LAA120	LAA125	LAA126	LAA127	LBA110	XBA170	LBA120	LBA126	LBA127	Units
Package Type	8 Pin DIP	8 Pin DIP	8 Pin DIP	8 Pin DIP	8 Pin DIP	8 Pin DIP	8 Pin DIP	8 Pin DIP	8 Pin DIP	8 Pin DIP	8 Pin DIP	-
Contact Form	2-Form-A	2-Form-A	2-Form-A	2-Form-A	2-Form-A	2-Form-A	1A/1B	1A/1B	1A/1B	1A/1B	1A/1B	-
Load Voltage (Peak)	350	350	250	300	250	250	350	350	250	250	250	V
Load Current (Continuous)	120	100	170	170	170	200	120	100	170	170	200	mA
On-Resistance @ Rated Load Current	35	50	20	16	15	10	35	50	20	15	10	Ω
Input Control Current (I _c)	5	5	5	5	5	5	5	5	5	5	5	mA

Part Number	LBB110	XBB170	LBB120	LBB126	LBB127	LCC110	LCC120	OAA160	PAA110	PAA140	Units
Package Type	8 Pin DIP	8 Pin DIP	8 Pin DIP	8 Pin DIP	8 Pin DIP	8 Pin DIP	8 Pin DIP	8 Pin DIP	8 Pin DIP	8 Pin DIP	-
Contact Form	2-Form-B	2-Form-B	2-Form-B	2-Form-B	2-Form-B	1-Form-C	1-Form-C	2-Form-A	2-Form-A	2-Form-A	-
Load Voltage (Peak)	350	350	250	250	250	350	250	250	400	400	V
Load Current (Continuous)	120	100	170	170	200	120	170	50	150	250	mA
On-Resistance @ Rated Load Current	35	50	20	15	10	35	20	100	22	8	Ω
Input Control Current (I _c)	5	5	5	5	5	8	10	10	5	5	mA

ORDERING INFORMATION

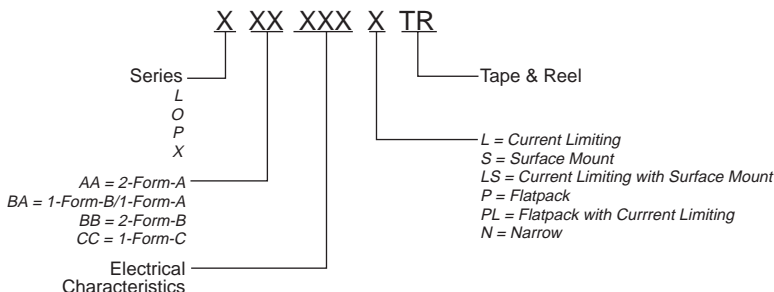



DESCRIPTION

The LAA110 is a 350V, 120mA, 35Ω type 2-Form-A solid state relay. Current limiting version available ("L" suffix).

FEATURES

- Small 8 Pin DIP Package
- Low Drive Power Requirements (TTL/CMOS Compatible)
- No Moving Parts
- High Reliability
- Arc-Free With No Snubbing Circuits
- 3750V_{RMS} Input/Output Isolation
- FCC Compatible
- VDE Compatible
- No EMI/RFI Generation
- Machine Insertable, Wave Solderable
- Current Limiting, Surface Mount and Tape & Reel Versions Available

APPROVALS

- UL Recognized: File Number E76270
- CSA Certified: File Number LR 43639-10
- BSI Certified to:
 - BS EN 60950:1992 (BS7002:1992)
Certificate #: 7344
 - BS EN 41003:1993
Certificate #: 7344

OPTIONS / SUFFIXES

- P: Flatpack Package
- L: Current Limiting
- S: Surface Mount Package
- TR: Tape & Reel

Switching Characteristics of Normally Open (Form A) Devices

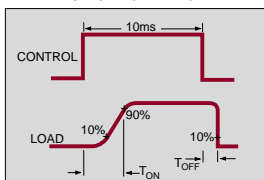

APPLICATIONS

- Telecommunications
 - Telecom Switching
 - Tip/Ring Circuits
 - Modem Switching (Laptop, Notebook, Pocket Size)
 - Hookswitch
 - Dial Pulsing
 - Ground Start
 - Ringer Injection
- Instrumentation
 - Multiplexers
 - Data Acquisition
 - Electronic Switching
 - I/O Subsystems
 - Meters (Watt-Hour, Water, Gas)
 - Medical Equipment-Patient/Equipment Isolation
- Security
- Aerospace
- Industrial Controls

RATINGS (@ 25° C)

Parameter	Min	Typ	Max	Units
Input Power Dissipation	-	-	150 ¹	mW
Input Control Current	-	-	50	mA
Peak (10ms)	-	-	1	A
Reverse Input Voltage	-	-	5	V
Total Power Dissipation	-	-	800 ²	mW
Capacitance				
Input to Output	-	3	-	pF
Isolation Voltage				
Input to Output	3750	-	-	V _{RMS}
Operational Temperature	-40	-	+85	°C
Storage Temperature	-40	-	+125	°C
Soldering Temperature (10 Seconds Max.)				
DIP Package	-	-	+260	°C
Flatpack/Surface Mount Package	-	-	+220	°C

¹ Derate Linearly 1.33 mW/°C

² Derate Linearly 1.67 mW/°C

Note: For Mechanical Dimensions See Pages 396-401

SPECIFICATIONS

LAA110

LAA110L

PARAMETERS	CONDITIONS	SYMBOL	MIN	TYP	MAX	MIN	TYP	MAX	UNITS
Output Characteristics @ 25°C									
Load Voltage (Peak)	-	V_L	-	-	350	-	-	350	V
Load Current (Continuous) AC/DC Configuration	-	I_L	-	-	120	-	-	120	mA
Peak Load Current	10ms max	I_{LPK}	-	-	350	-	-	-	mA
On-Resistance AC/DC Configuration	$I_L=120\text{mA}$	R_{ON}	-	25	35	-	30	35	Ω
Off-State Leakage Current	$V_L=350\text{V}$	I_{LEAK}	-	-	1	-	-	1	μA
Switching Speeds									
Turn-On	$I_F=5\text{mA}, V_L=10\text{V}$	T_{ON}	-	-	3	-	-	3	ms
Turn-Off	$I_F=5\text{mA}, V_L=10\text{V}$	T_{OFF}	-	-	3	-	-	3	ms
Output Capacitance	50V; f=1MHz	C_{OUT}	-	25	-	-	25	-	pF
Load Current Limiting		I_{CL}	-	-	-	130	170	210	mA
Input Characteristics @ 25°C									
Input Control Current	$I_L=120\text{mA}$	I_F	5	-	50	5	-	50	mA
Input Dropout Current	-	-	0.4	0.7	-	0.4	0.7	-	mA
Input Voltage Drop	$I_F=5\text{mA}$	V_F	0.9	1.2	1.4	0.9	1.2	1.4	V
Reverse Input Voltage	-	V_R	-	-	5	-	-	5	V
Reverse Input Current	$V_R=5\text{V}$	I_R	-	-	10	-	-	10	μA
Input to Output Capacitance	-	$C_{I/O}$	-	3	-	-	3	-	pF
Input to Output Isolation	-	$V_{I/O}$	3750	-	-	3750	-	-	V_{RMS}

LAA110 Pinout

AC/DC Configuration

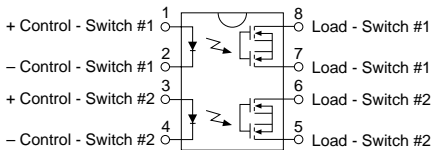

LAA110L Pinout

AC/DC Configuration

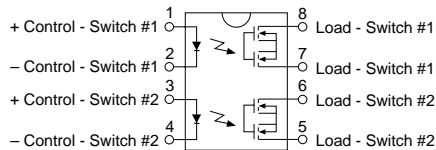

Note: For Mechanical Dimensions See Pages 396-401

PERFORMANCE DATA

LAA110
Typical LED Forward Voltage Drop
(N=50 Ambient Temperature = 25°C)
I_F = 5mA

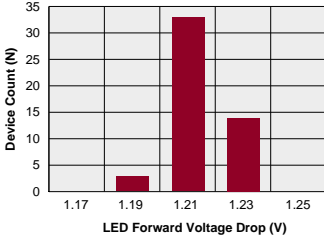

LAA110
Typical On-Resistance Distribution
(N=50 Ambient Temperature = 25°C)
(Load Current = 120mA)

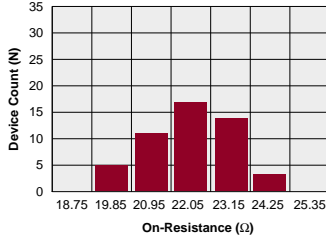

LAA110
Typical Blocking Voltage Distribution
(N=50 Ambient Temperature = 25°C)

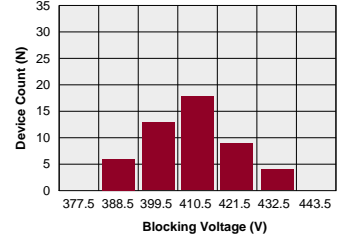

LAA110
Typical I_F for Switch Operation
(N=50 Ambient Temperature = 25°C)
(Load Current = 120mA)

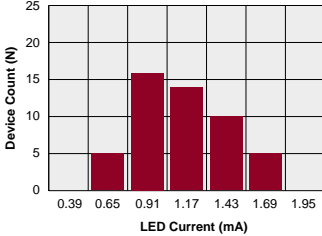

LAA110
Typical I_F for Switch Dropout
(N=50 Ambient Temperature = 25°C)
(Load Current = 120mA)

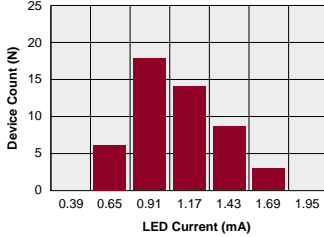

LAA110
Typical Turn-On Time
(N=50 Ambient Temperature = 25°C)
(Load Current = 120mA; I_F = 5mA)

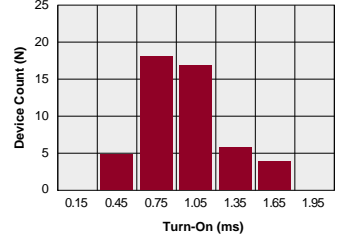

LAA110
Typical Turn-Off Time
(N=50 Ambient Temperature = 25°C)
(Load Current = 120mA; I_F = 5mA)

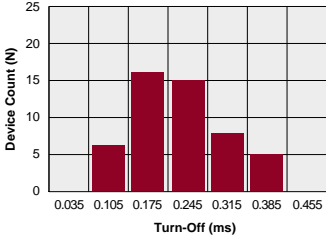

LAA110
Typical Load Current vs. Temperature

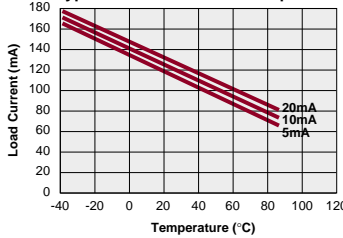

LAA110
Typical Leakage vs. Temperature
(Measured across Pins 5 & 6 or 7 & 8)

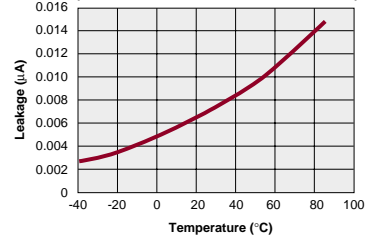

LAA110
Typical Blocking Voltage vs. Temperature

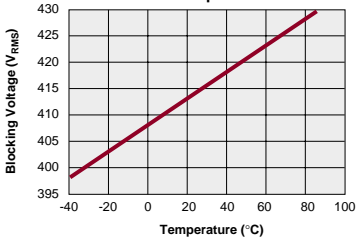

LAA110
Typical Turn-On vs. Temperature
(Load Current = 120mA)

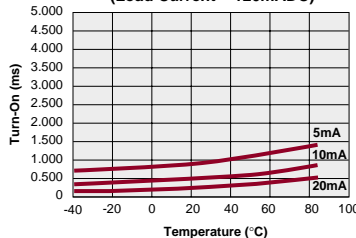

LAA110
Typical Turn-Off vs. Temperature
(Load Current = 120mA)

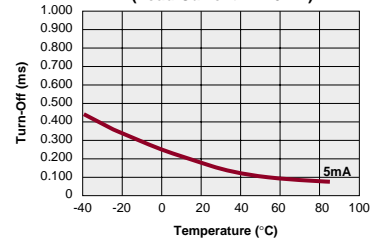

LAA110/LAA110L

PERFORMANCE DATA

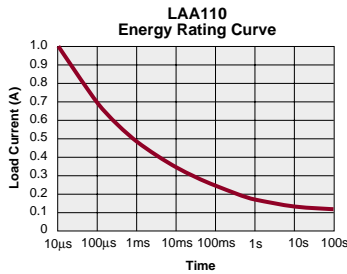
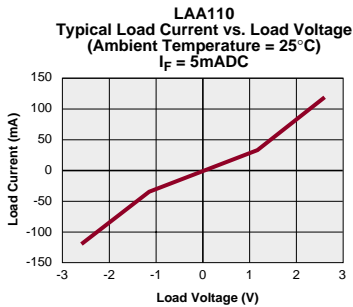
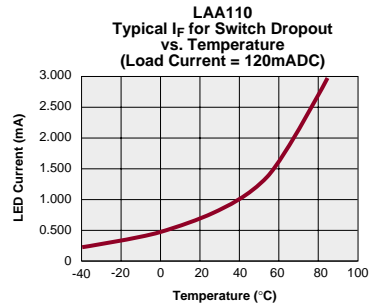
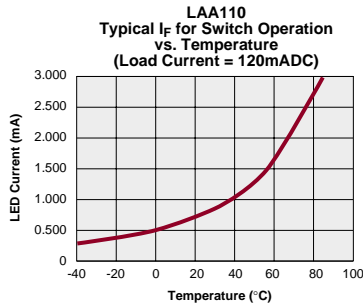
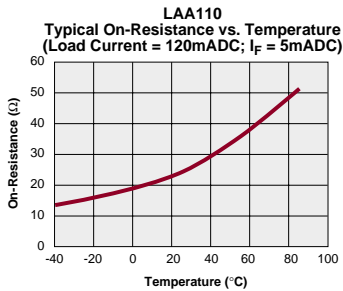
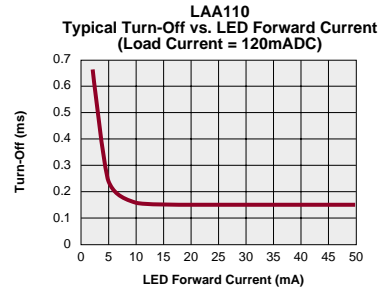
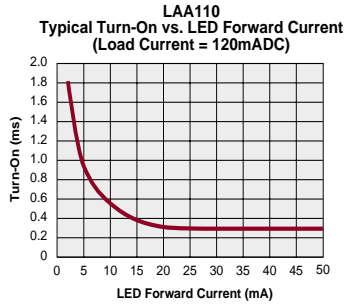
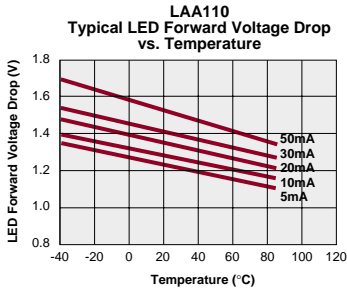

PERFORMANCE DATA

LAA110L
Typical LED Forward Voltage Drop
(N=50 Ambient Temperature = 25°C)
I_F = 5mA

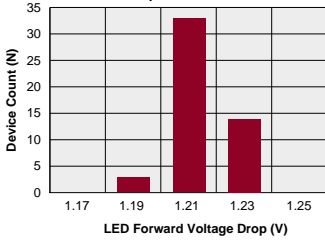

LAA110L
Typical On-Resistance Distribution
(N=50 Ambient Temperature = 25°C)
(Load Current = 120mA; I_F = 5mA)

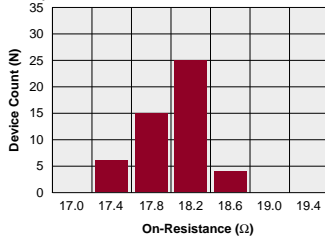

LAA110L
Typical Blocking Voltage Distribution
(N=50 Ambient Temperature = 25°C)

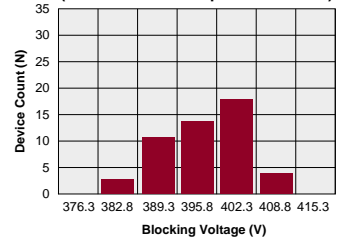

LAA110L
Typical I_F for Switch Operation
(N=50 Ambient Temperature = 25°C)
(Load Current = 120mA)

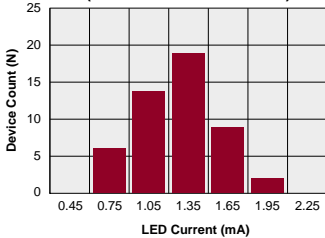

LAA110L
Typical I_F for Switch Dropout
(N=50 Ambient Temperature = 25°C)
(Load Current = 120mA)

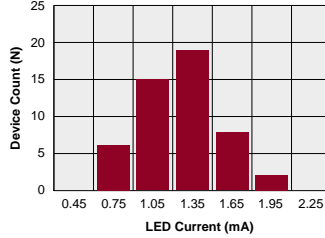

LAA110L
Typical Turn-On Time
(N=50 Ambient Temperature = 25°C)
(Load Current = 120mA; I_F = 5mA)

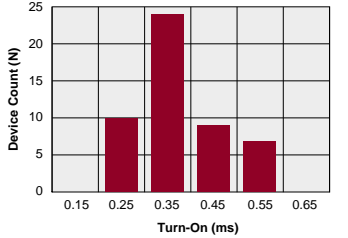

LAA110L
Typical Turn-Off Time
(N=50 Ambient Temperature = 25°C)
(Load Current = 120mA; I_F = 5mA)

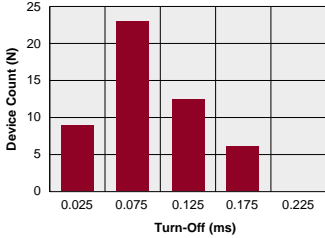

LAA110L
Typical Load Current vs. Temperature

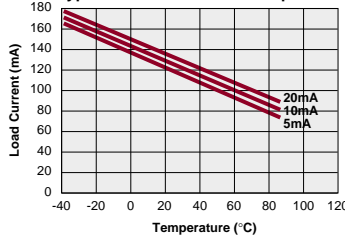

LAA110L
Typical Leakage vs. Temperature
(Measured across Pins 5 & 6 or 7 & 8)

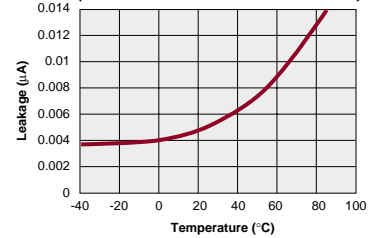

LAA110L
Typical Blocking Voltage vs. Temperature

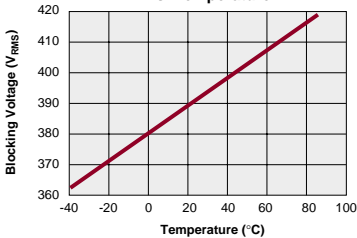

LAA110L
Typical Turn-On vs. Temperature
(Load Current = 120mA)

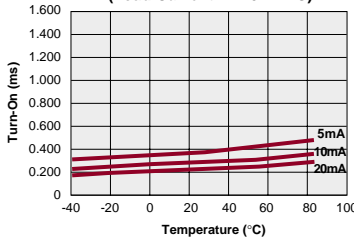

LAA110L
Typical Turn-Off vs. Temperature
(Load Current = 120mA)

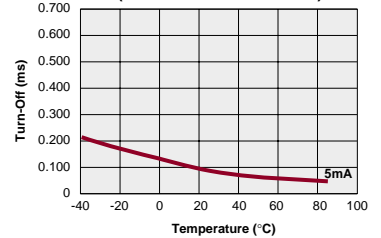

LAA110/LAA110L

PERFORMANCE DATA

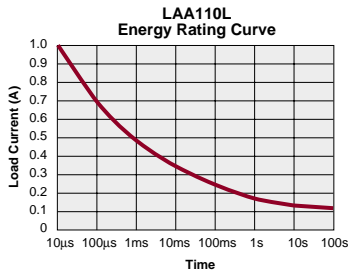
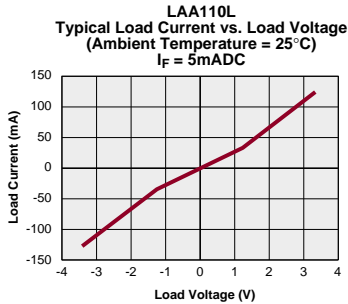
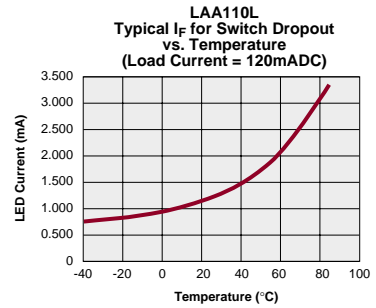
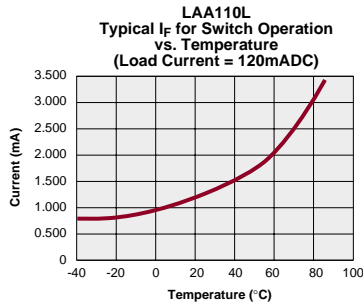
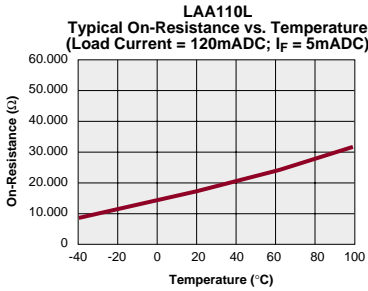
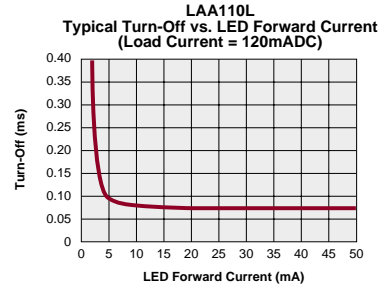
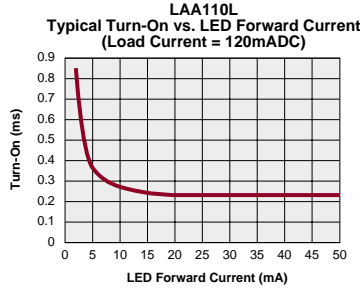
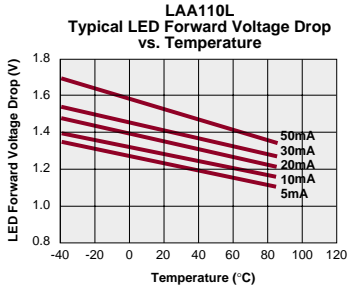



DESCRIPTION

The XAA170 is a 350V, 120mA, 50Ω type 2-Form-A solid state relay.

FEATURES

- Small 8 Pin DIP Package
- Low Drive Power Requirements (TTL/CMOS Compatible)
- No Moving Parts
- High Reliability
- Arc-Free With No Snubbing Circuits
- 3750V_{RMS} Input/Output Isolation
- FCC Compatible
- VDE Compatible
- No EMI/RFI Generation
- Machine Insertable, Wave Solderable
- Current Limiting, Surface Mount and Tape & Reel Versions Available

APPROVALS

- UL Recognized: File Number E76270
- CSA Certified: File Number LR 43639-10
- BSI Certified to:
 - BS EN 60950:1992 (BS7002:1992)
Certificate #: 7344
 - BS EN 41003:1993
Certificate #: 7344

OPTIONS / SUFFIXES

- P: Flatpack Package
- S: Surface Mount Package
- TR: Tape & Reel

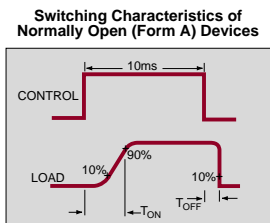

APPLICATIONS

- Telecommunications
 - Telecom Switching
 - Tip/Ring Circuits
 - Modem Switching (Laptop, Notebook, Pocket Size)
 - Hookswitch
 - Dial Pulsing
 - Ground Start
 - Ringer Injection
- Instrumentation
 - Multiplexers
 - Data Acquisition
 - Electronic Switching
 - I/O Subsystems
 - Meters (Watt-Hour, Water, Gas)
 - Medical Equipment-Patient/Equipment Isolation
- Security
- Aerospace
- Industrial Controls

RATINGS (@ 25° C)

Parameter	Min	Typ	Max	Units
Input Power Dissipation	-	-	150 ¹	mW
Input Control Current	-	-	50	mA
Peak (10ms)	-	-	1	A
Reverse Input Voltage	-	-	5	V
Total Power Dissipation	-	-	800 ²	mW
Capacitance				
Input to Output	-	3	-	pF
Isolation Voltage				
Input to Output	3750	-	-	V _{RMS}
Operational Temperature	-40	-	+85	°C
Storage Temperature	-40	-	+125	°C
Soldering Temperature (10 Seconds Max.)				
DIP Package	-	-	+260	°C
Flatpack/Surface Mount Package	-	-	+220	°C

¹ Derate Linearly 1.33 mW/°C

² Derate Linearly 1.67 mW/°C

Note: For Mechanical Dimensions See Pages 396-401

SPECIFICATIONS

PARAMETERS	CONDITIONS	SYMBOL	MIN	TYP	MAX	UNITS
Output Characteristics @ 25°C						
Load Voltage (Peak)	-	V_L	-	-	350	V
Load Current (Continuous) AC/DC Configuration	-	I_L	-	-	100	mA
Peak Load Current	10ms max	I_{LPK}	-	-	350	mA
On-Resistance AC/DC Configuration	$I_L=120mA$	R_{ON}	-	33	50	Ω
Off-State Leakage Current	$V_L=350V$	I_{LEAK}	-	-	1	μA
Switching Speeds						
Turn-On	$I_F=5mA, V_L=10V$	T_{ON}	-	-	5	ms
Turn-Off	$I_F=5mA, V_L=10V$	T_{OFF}	-	-	5	ms
Output Capacitance	50V; f=1MHz	C_{OUT}	-	25	-	pF
Load Current Limiting	-	I_{CL}	-	-	-	mA
Input Characteristics @ 25°C						
Input Control Current	$I_L=120mA$	I_F	5	-	50	mA
Input Dropout Current	-	-	0.4	0.7	-	mA
Input Voltage Drop	$I_F=5mA$	V_F	0.9	1.2	1.4	V
Reverse Input Voltage	-	V_R	-	-	5	V
Reverse Input Current	$V_I=5V$	I_R	-	-	10	μA
Input to Output Capacitance	-	$C_{I/O}$	-	3	-	pF
Input to Output Isolation	-	$V_{I/O}$	3750	-	-	V_{RMS}

XAA170 Pinout

AC/DC Configuration

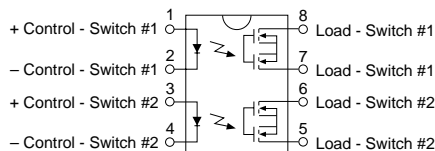

Note: For Mechanical Dimensions See Pages 396-401

PERFORMANCE DATA

XAA170
Typical LED Forward Voltage Drop
(N=50 Ambient Temperature = 25°C)
I_F = 5mA

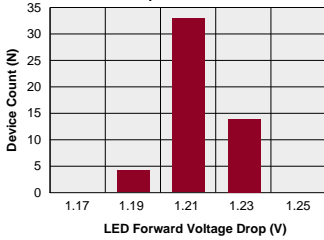

XAA170
Typical On-Resistance Distribution
(N=50 Ambient Temperature = 25°C)
(Load Current = 100mA)

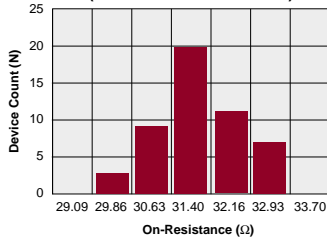

XAA170
Typical Blocking Voltage Distribution
(N=50 Ambient Temperature = 25°C)

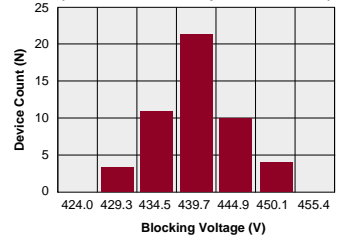

XAA170
Typical I_F for Switch Operation
(N=50 Ambient Temperature = 25°C)
(Load Current = 100mA)

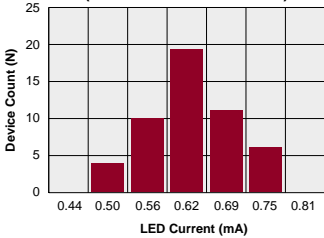

XAA170
Typical I_F for Switch Dropout
(N=50 Ambient Temperature = 25°C)
(Load Current = 100mA)

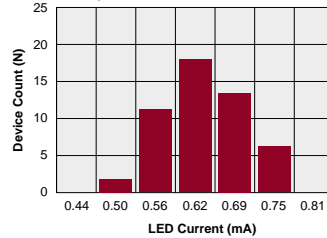

XAA170
Typical Turn-On Time
(N=50 Ambient Temperature = 25°C)
(Load Current = 100mA)

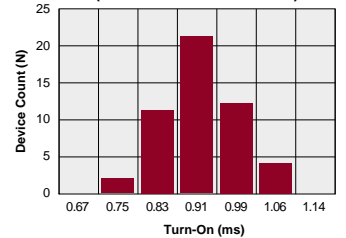

XAA170
Typical Turn-Off Time
(N=50 Ambient Temperature = 25°C)
(Load Current = 100mA)

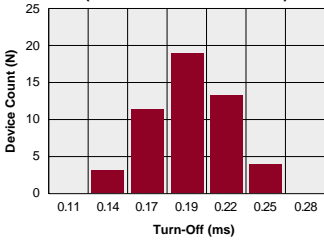

XAA170
Typical Load Current vs. Temperature

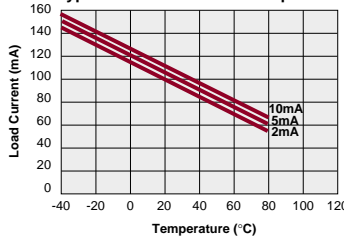

XAA170
Typical Leakage vs. Temperature
(Measured across Pins 4 & 6)

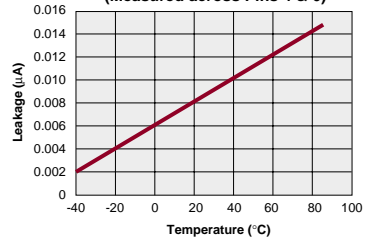

XAA170
Typical Blocking Voltage vs. Temperature

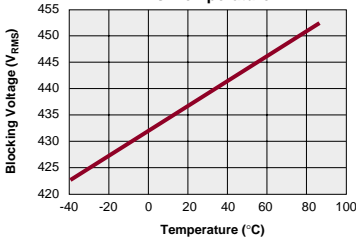

XAA170
Typical Turn-On vs. Temperature
(Load Current = 100mA)

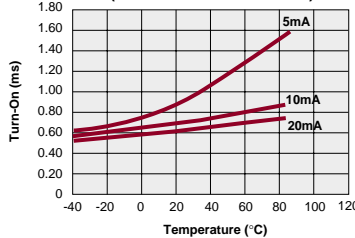

XAA170
Typical Turn-Off vs. Temperature
(Load Current = 120mA)

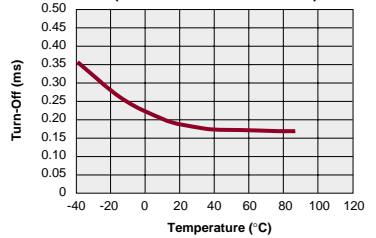

XAA170

PERFORMANCE DATA

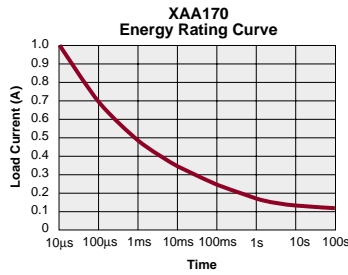
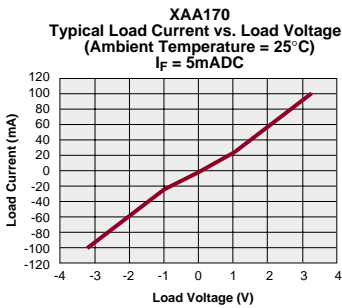
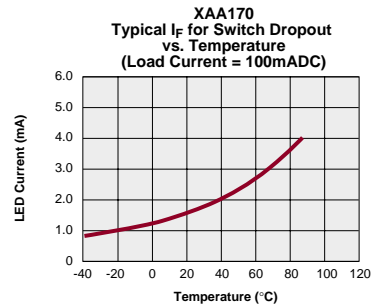
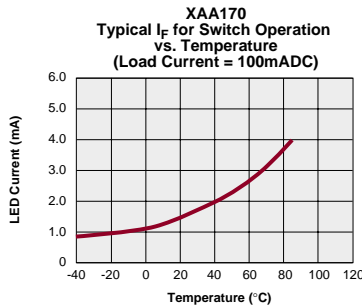
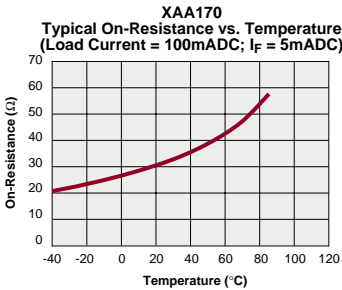
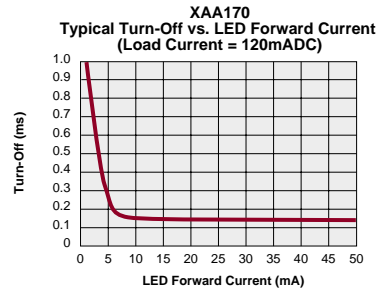
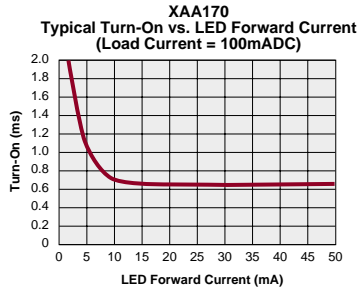
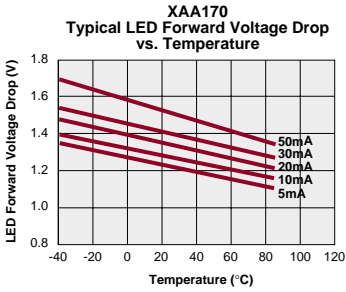



DESCRIPTION

The LAA120 is a 250V, 170mA, 20Ω type 2-Form-A solid state relay. Current limiting version available ("L" suffix).

FEATURES

- Small 8 Pin DIP Package
- Low Drive Power Requirements (TTL/CMOS Compatible)
- No Moving Parts
- High Reliability
- Arc-Free With No Snubbing Circuits
- 3750V_{RMS} Input/Output Isolation
- FCC Compatible
- VDE Compatible
- No EMI/RFI Generation
- Machine Insertable, Wave Solderable
- Current Limiting, Surface Mount and Tape & Reel Versions Available

APPROVALS

- UL Recognized: File Number E76270
- CSA Certified: File Number LR 43639-10
- BSI Certified to:
 - BS EN 60950:1992 (BS7002:1992)
Certificate #: 7344
 - BS EN 41003:1993
Certificate #: 7344

OPTIONS / SUFFIXES

- P: Flatpack Package
- L: Current Limiting
- S: Surface Mount Package
- TR: Tape & Reel

Switching Characteristics of Normally Open (Form A) Devices

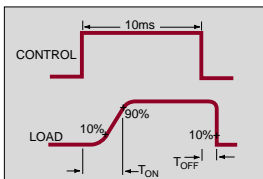

APPLICATIONS

- Telecommunications
 - Telecom Switching
 - Tip/Ring Circuits
 - Modem Switching (Laptop, Notebook, Pocket Size)
 - Hookswitch
 - Dial Pulsing
 - Ground Start
 - Ringer Injection
- Instrumentation
 - Multiplexers
 - Data Acquisition
 - Electronic Switching
 - I/O Subsystems
 - Meters (Watt-Hour, Water, Gas)
 - Medical Equipment-Patient/Equipment Isolation
- Security
- Aerospace
- Industrial Controls

RATINGS (@ 25° C)

Parameter	Min	Typ	Max	Units
Input Power Dissipation	-	-	150 ¹	mW
Input Control Current	-	-	50	mA
Peak (10ms)	-	-	1	A
Reverse Input Voltage	-	-	5	V
Total Power Dissipation	-	-	800 ²	mW
Capacitance				
Input to Output	-	3	-	pF
Isolation Voltage				
Input to Output	3750	-	-	V _{RMS}
Operational Temperature	-40	-	+85	°C
Storage Temperature	-40	-	+125	°C
Soldering Temperature (10 Seconds Max.)				
DIP Package	-	-	+260	°C
Flatpack/Surface Mount Package	-	-	+220	°C

¹ Derate Linearly 1.33 mw/°C
² Derate Linearly 1.67 mw/°C

Note: For Mechanical Dimensions See Pages 396-401

SPECIFICATIONS

PARAMETERS	CONDITIONS	SYMBOL	LAA120			LAA120L			UNITS
			MIN	TYP	MAX	MIN	TYP	MAX	
Output Characteristics @ 25°C									
Load Voltage (Peak)	-	V_L	-	-	250	-	-	250	V
Load Current (Continuous) AC/DC Configuration	-	I_L	-	-	170	-	-	150	mA
Peak Load Current	10ms max	I_{LPK}	-	-	400	-	-	-	mA
On-Resistance AC/DC Configuration	I_L =Load Current	R_{ON}	-	15	20	-	12	25	Ω
Off-State Leakage Current	V_L =250V	I_{LEAK}	-	-	1	-	-	1	μ A
Switching Speeds									
Turn-On	I_F =5mA, V_L =10V	T_{ON}	-	-	5	-	-	5	ms
Turn-Off	I_F =5mA, V_L =10V	T_{OFF}	-	-	5	-	-	5	ms
Output Capacitance	50V; f=1MHz	C_{OUT}	-	50	-	-	50	-	pF
Load Current Limiting	-	I_{CL}	-	-	-	190	235	280	mA
Input Characteristics @ 25°C									
Input Control Current	I_L =Load Current	I_F	5	-	50	5	-	50	mA
Input Dropout Current	-	-	0.4	0.7	-	0.4	0.7	-	mA
Input Voltage Drop	I_F =5mA	V_F	0.9	1.2	1.4	0.9	1.2	1.4	V
Reverse Input Voltage	-	V_R	-	-	5	-	-	5	V
Reverse Input Current	V_F =5V	I_R	-	-	10	-	-	10	μ A
Input to Output Capacitance	-	$C_{I/O}$	-	3	-	-	3	-	pF
Input to Output Isolation	-	$V_{I/O}$	3750	-	-	3750	-	-	V_{RMS}

LAA120 Pinout

AC/DC Configuration

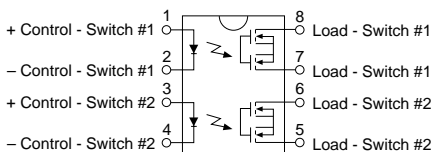

LAA120L Pinout

AC/DC Configuration

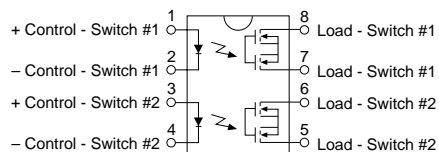

Note: For Mechanical Dimensions See Pages 396-401

PERFORMANCE DATA

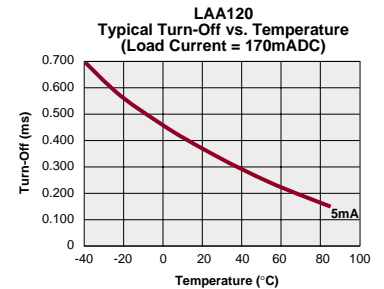
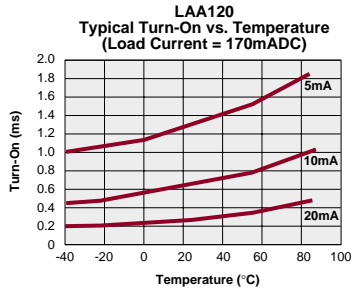
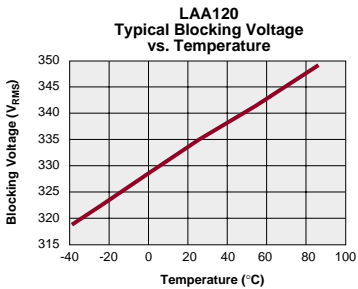
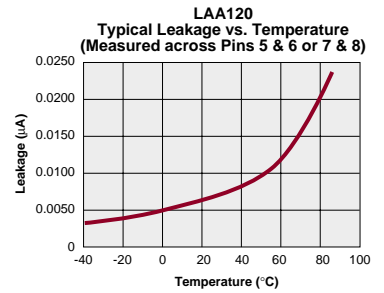
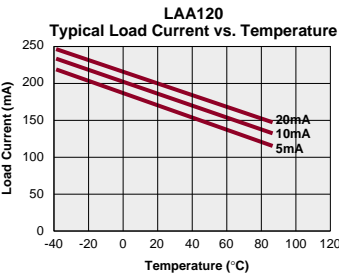
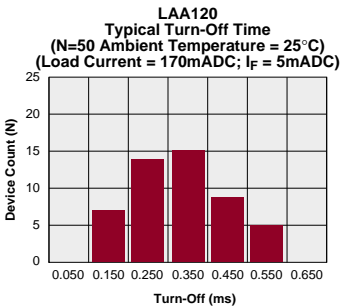
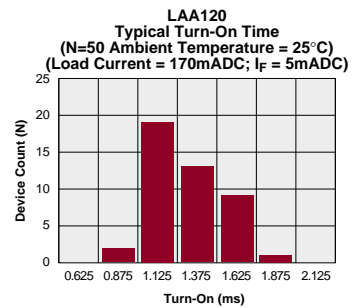
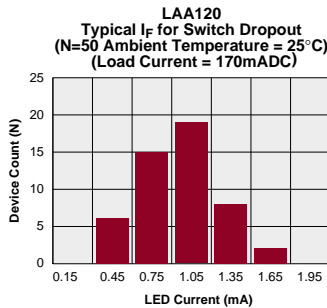
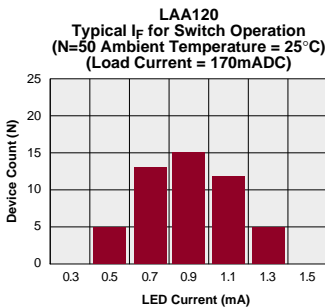
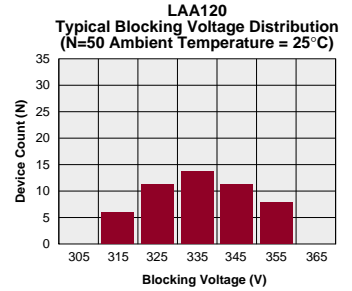
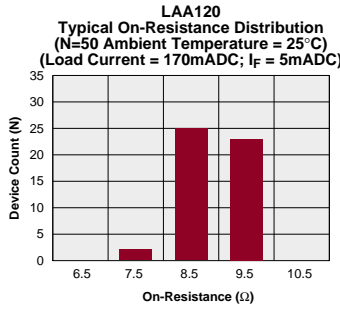
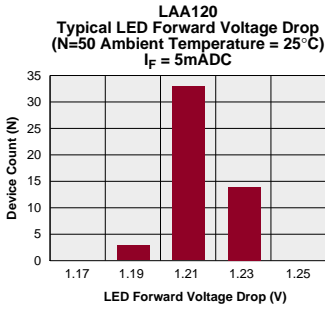

PERFORMANCE DATA

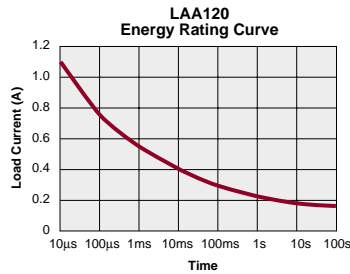
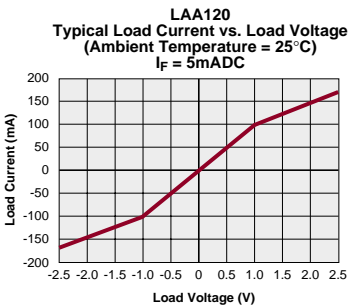
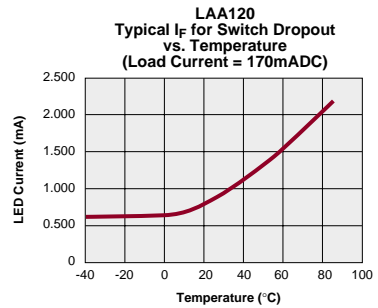
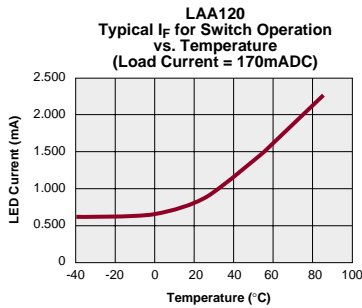
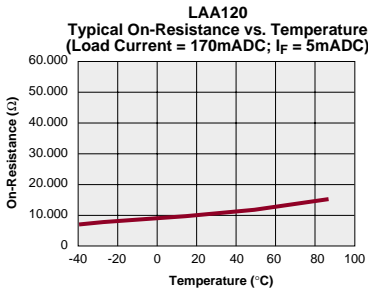
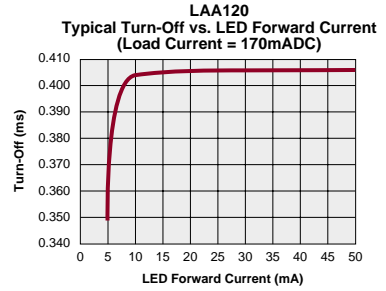
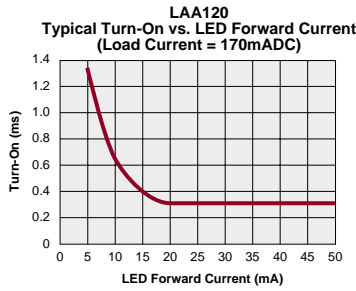
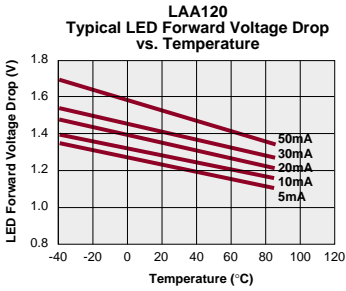

PERFORMANCE DATA

LAA120L
Typical LED Forward Voltage Drop
(N=50 Ambient Temperature = 25°C)
I_F = 5mA

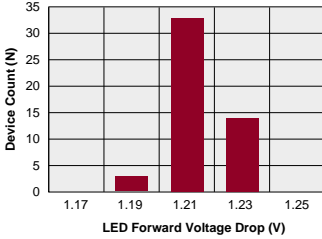

LAA120L
Typical On-Resistance Distribution
(N=50 Ambient Temperature = 25°C)
(Load Current = 170mADC)

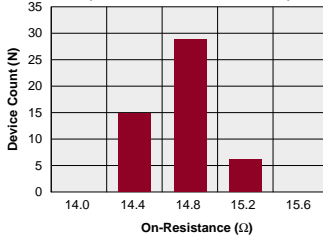

LAA120L
Typical Blocking Voltage Distribution
(N=50 Ambient Temperature = 25°C)

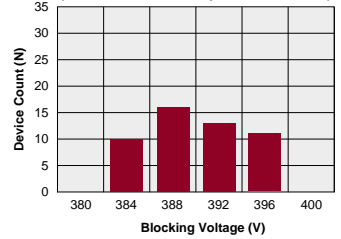

LAA120L
Typical I_F for Switch Operation
(N=50 Ambient Temperature = 25°C)
(Load Current = 170mADC)

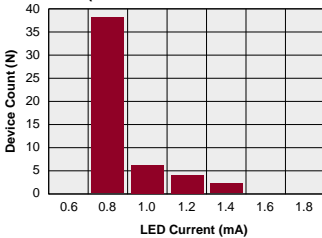

LAA120L
Typical I_F for Switch Dropout
(N=50 Ambient Temperature = 25°C)
(Load Current = 170mADC)

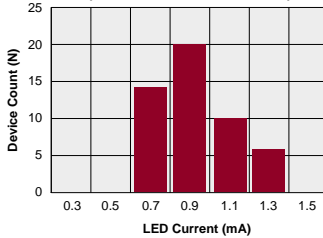

LAA120L
Typical Turn-On Time
(N=50 Ambient Temperature = 25°C)
(Load Current = 170mADC; I_F = 5mA)

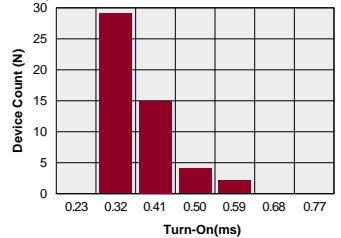

LAA120L
Typical Turn-Off Time
(N=50 Ambient Temperature = 25°C)
(Load Current = 170mADC; I_F = 5mA)

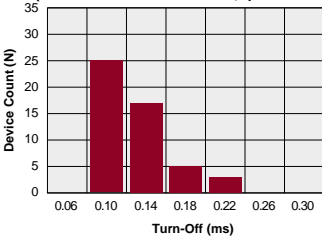

LAA120L
Typical Load Current vs. Temperature

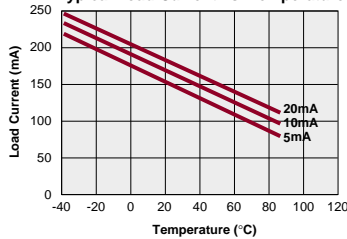

LAA120L
Typical Leakage vs. Temperature
(Measured across Pins 5 & 6 or 7 & 8)

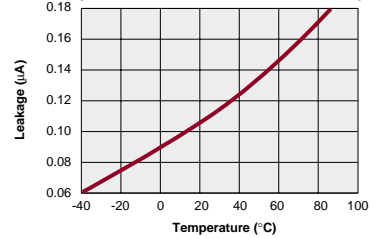

LAA120L
Typical Blocking Voltage vs. Temperature

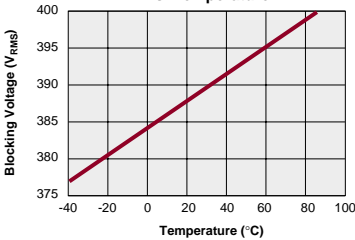

LAA120L
Typical Turn-On vs. Temperature
(Load Current = 170mADC)

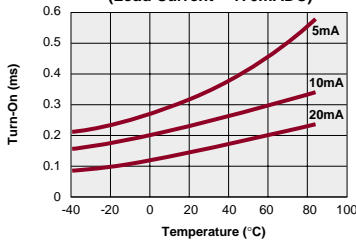

LAA120L
Typical Turn-Off vs. Temperature
(Load Current = 170mADC)

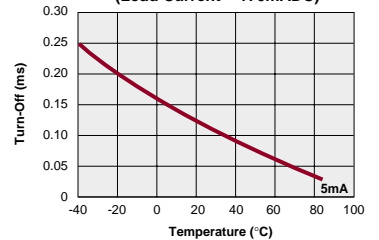

PERFORMANCE DATA

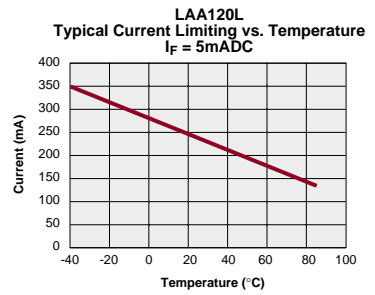
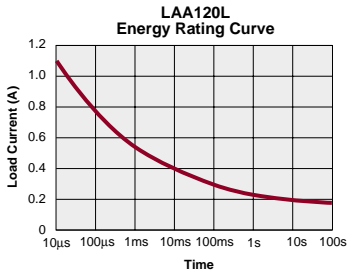
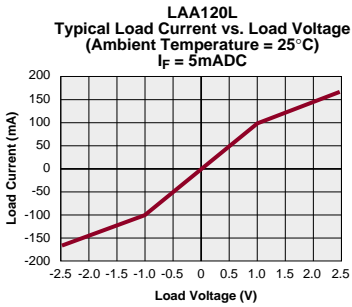
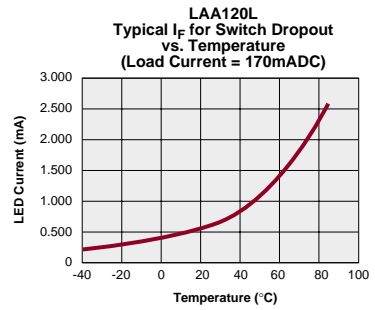
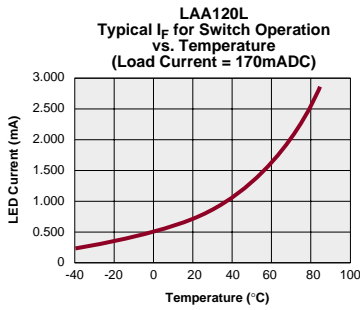
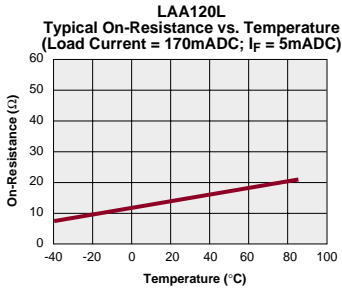
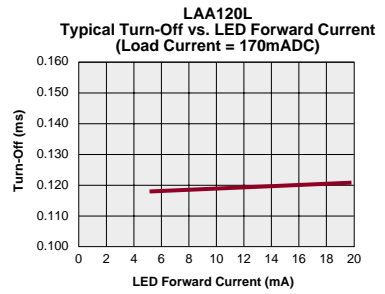
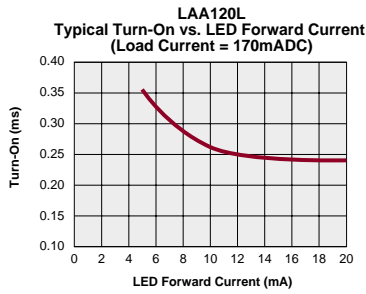
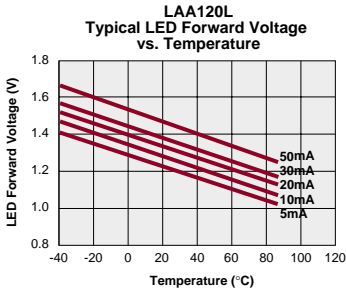



DESCRIPTION

The LAA125 is a 300V, 170mA, 16Ω type 2-Form-A solid state relay. Current limiting version available ("L" suffix).

FEATURES

- Small 8 Pin DIP Package
- Low Drive Power Requirements (TTL/CMOS Compatible)
- No Moving Parts
- High Reliability
- Arc-Free With No Snubbing Circuits
- 3750V_{RMS} Input/Output Isolation
- FCC Compatible
- VDE Compatible
- No EMI/RFI Generation
- Machine Insertable, Wave Solderable
- Current Limiting, Surface Mount and Tape & Reel Versions Available

APPROVALS

- UL Recognized: File Number E76270
- CSA Certified: File Number LR 43639-10
- BSI Certified to:
 - BS EN 60950:1992 (BS7002:1992)
Certificate #: 7344
 - BS EN 41003:1993
Certificate #: 7344

OPTIONS / SUFFIXES

- P: Flatpack Package
- L: Current Limiting
- S: Surface Mount Package
- TR: Tape & Reel

Switching Characteristics of Normally Open (Form A) Devices

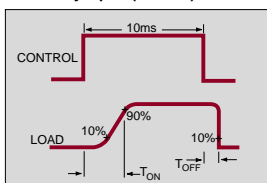

APPLICATIONS

- Telecommunications
 - Telecom Switching
 - Tip/Ring Circuits
 - Modem Switching (Laptop, Notebook, Pocket Size)
 - Hookswitch
 - Dial Pulsing
 - Ground Start
 - Ringer Injection
- Instrumentation
 - Multiplexers
 - Data Acquisition
 - Electronic Switching
 - I/O Subsystems
 - Meters (Watt-Hour, Water, Gas)
 - Medical Equipment-Patient/Equipment Isolation
- Security
- Aerospace
- Industrial Controls

RATINGS (@ 25° C)

Parameter	Min	Typ	Max	Units
Input Power Dissipation	-	-	150 ¹	mW
Input Control Current	-	-	50	mA
Peak (10ms)	-	-	1	A
Reverse Input Voltage	-	-	5	V
Total Power Dissipation	-	-	800 ²	mW
Capacitance				
Input to Output	-	3	-	pF
Isolation Voltage				
Input to Output	3750	-	-	V _{RMS}
Operational Temperature	-40	-	+85	°C
Storage Temperature	-40	-	+125	°C
Soldering Temperature				
(10 Seconds Max.)				
DIP Package	-	-	+260	°C
Flatpack/Surface Mount Package	-	-	+220	°C

¹ Derate Linearly 1.33 mW/°C
² Derate Linearly 1.67 mW/°C

Note: For Mechanical Dimensions See Pages 396-401

SPECIFICATIONS

PARAMETERS	CONDITIONS	SYMBOL	LAA125			LAA125L			UNITS
			MIN	TYP	MAX	MIN	TYP	MAX	
Output Characteristics @ 25°C									
Load Voltage (Peak)	-	V_L	-	-	300	-	-	300	V
Load Current (Continuous)	-	I_L	-	-	170	-	-	150	mA
Peak Load Current	10ms max	I_{LPK}	-	-	400	-	-	-	mA
On-Resistance	I_L =Load Current	R_{ON}	-	10	16	-	12	18	Ω
Off-State Leakage Current	V_L =300V	I_{LEAK}	-	-	1	-	-	1	μ A
Switching Speeds									
Turn-On	I_F =5mA, V_L =10V	T_{ON}	-	-	5	-	-	5	ms
Turn-Off	I_F =5mA, V_L =10V	T_{OFF}	-	-	5	-	-	5	ms
Output Capacitance	50V; f=1MHz	C_{OUT}	-	50	-	-	50	-	pF
Load Current Limiting	-	I_{CL}	-	-	-	190	235	280	mA
Input Characteristics @ 25°C									
Input Control Current	I_L =120mA	I_F	5	-	50	5	-	50	mA
Input Dropout Current	-	-	0.4	0.7	-	0.4	0.7	-	mA
Input Voltage Drop	I_F =5mA	V_F	0.9	1.2	1.4	0.9	1.2	1.4	V
Reverse Input Voltage	-	V_R	-	-	5	-	-	5	V
Reverse Input Current	V_R =5V	I_R	-	-	10	-	-	10	μ A
Input to Output Capacitance	-	$C_{I/O}$	-	3	-	-	3	-	pF
Input to Output Isolation	-	$V_{I/O}$	3750	-	-	3750	-	-	V_{RMS}

LAA125 Pinout

AC/DC Configuration

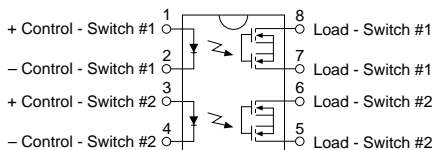

LAA125L Pinout

AC/DC Configuration

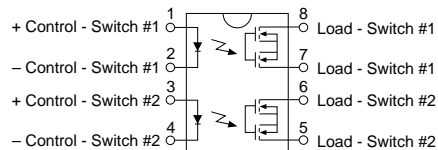

Note: For Mechanical Dimensions See Pages 396-401

PERFORMANCE DATA

LAA125
Typical LED Forward Voltage Drop
(N=50 Ambient Temperature = 25°C)
I_F = 5mAADC

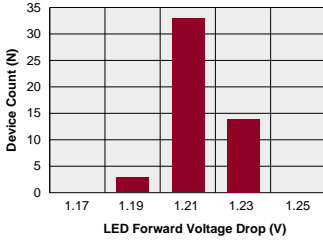

LAA125
Typical On-Resistance Distribution
(N=50 Ambient Temperature = 25°C)
(Load Current = 170mAADC; I_F = 5mAADC)

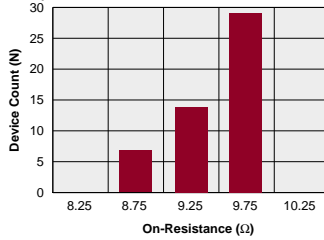

LAA125
Typical Blocking Voltage Distribution
(N=50 Ambient Temperature = 25°C)

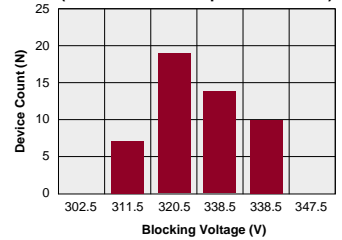

LAA125
Typical I_F for Switch Operation
(N=50 Ambient Temperature = 25°C)
(Load Current = 170mAADC)

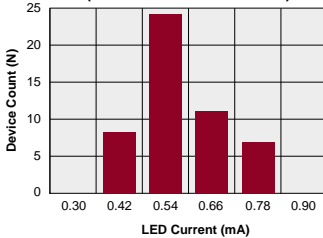

LAA125
Typical I_F for Switch Dropout
(N=50 Ambient Temperature = 25°C)
(Load Current = 170mAADC)

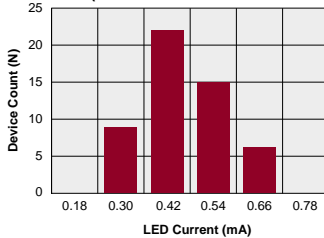

LAA125
Typical Turn-On Time
(N=50 Ambient Temperature = 25°C)
(Load Current = 170mAADC; I_F = 5mAADC)

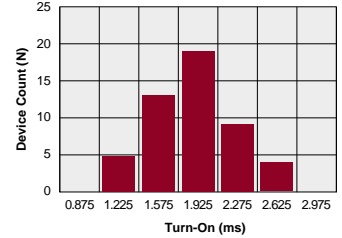

LAA125
Typical Turn-Off Time
(N=50 Ambient Temperature = 25°C)
(Load Current = 170mAADC; I_F = 5mAADC)

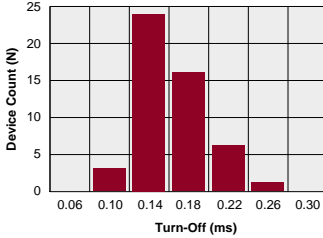

LAA125
Typical Load Current vs. Temperature

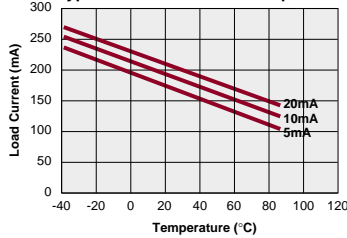

LAA125
Typical Leakage vs. Temperature
(Measured across Pins 5 & 6 or 7 & 8)

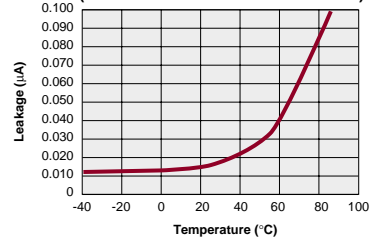

LAA125
Typical Blocking Voltage vs. Temperature

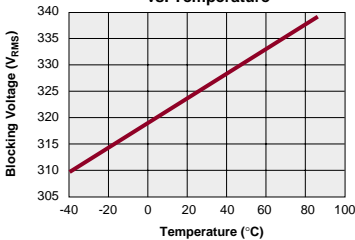

LAA125
Typical Turn-On vs. Temperature
(Load Current = 170mAADC)

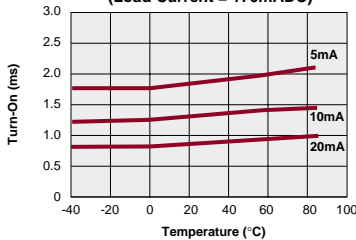

LAA125
Typical Turn-Off vs. Temperature
(Load Current = 170mAADC)

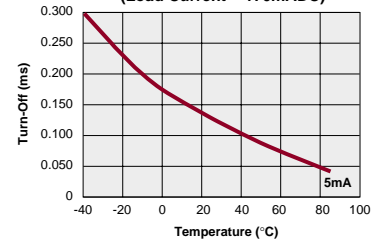

PERFORMANCE DATA

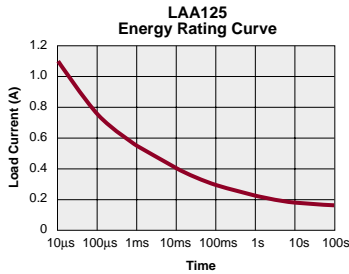
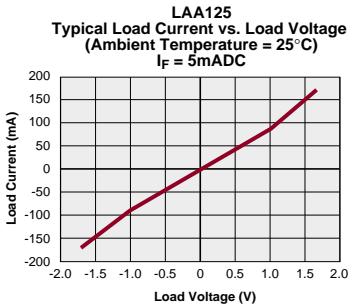
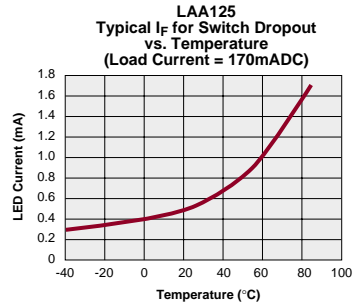
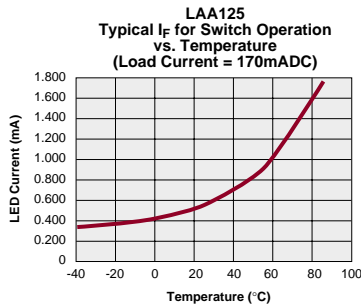
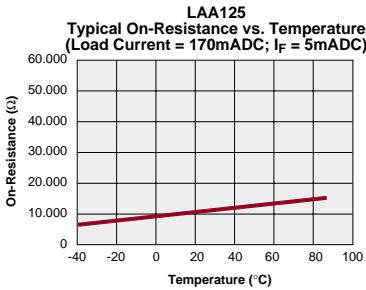
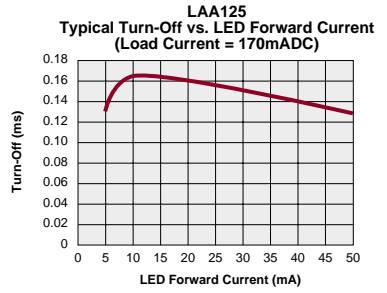
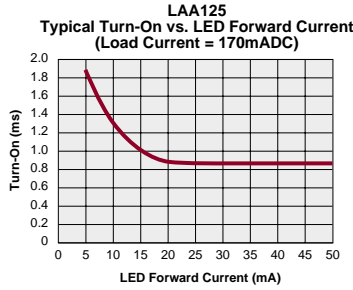
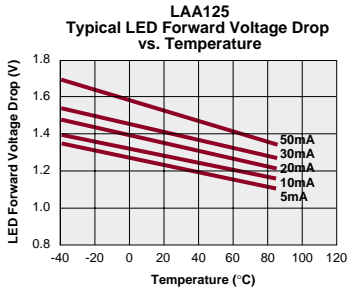

PERFORMANCE DATA

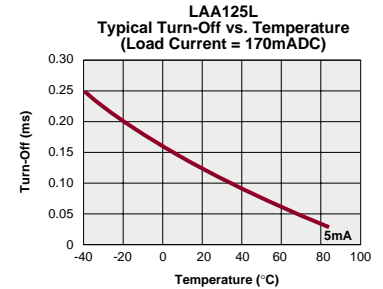
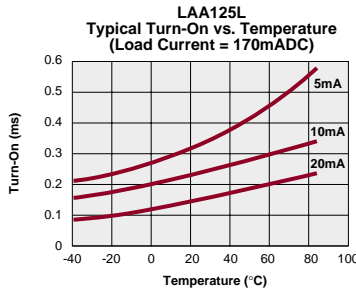
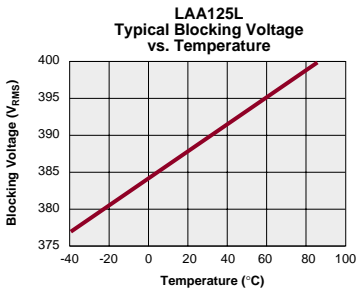
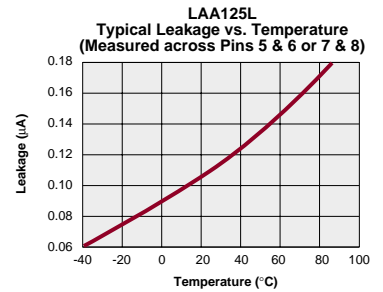
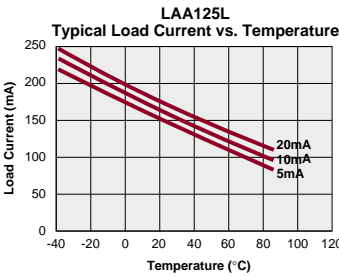
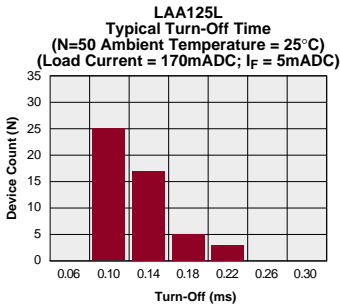
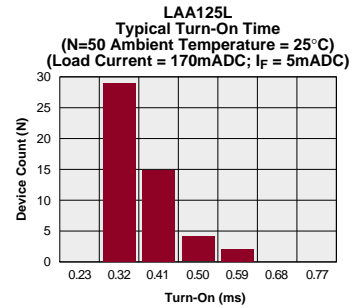
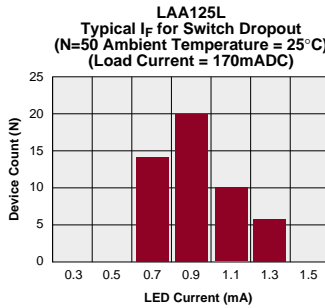
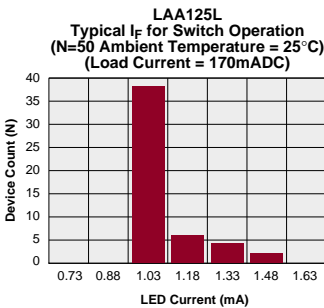
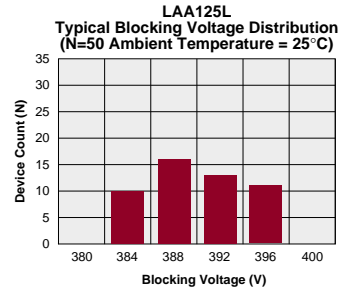
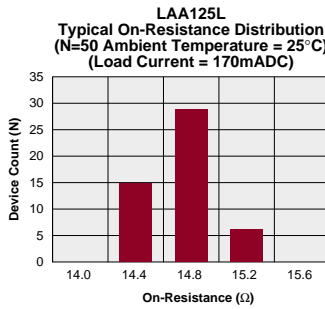
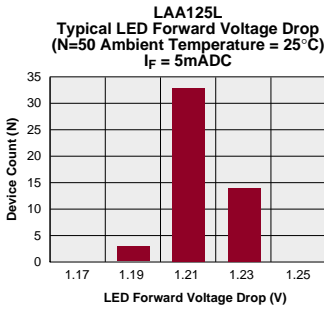

PERFORMANCE DATA

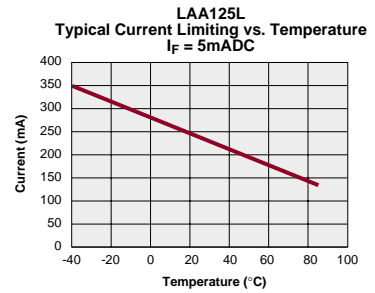
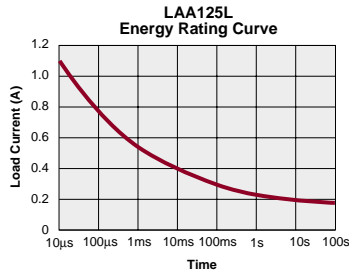
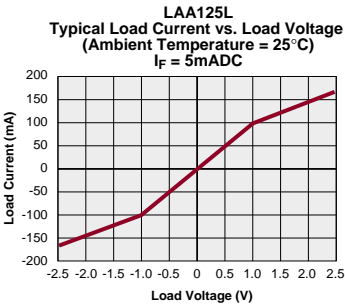
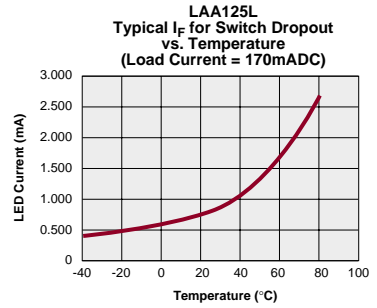
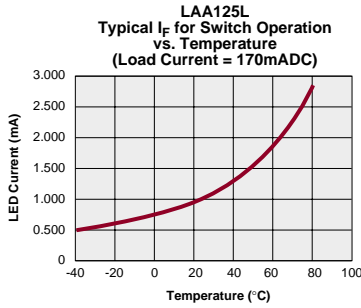
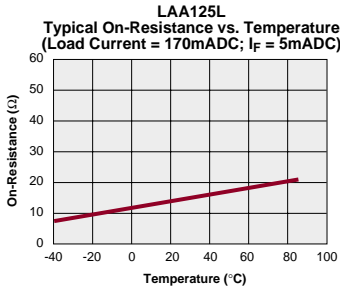
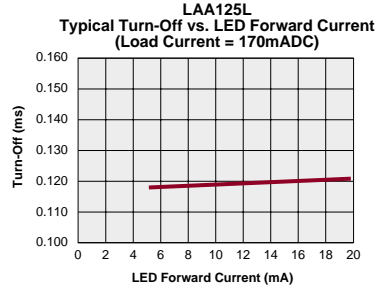
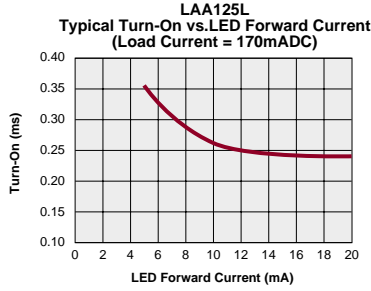
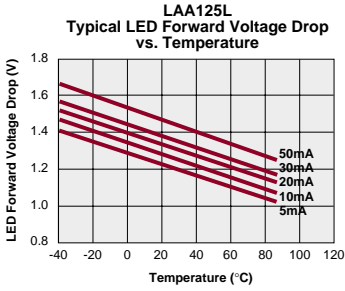



DESCRIPTION

The LAA126 is a 250V, 170mA, 15Ω type 2-Form-A solid state relay.

FEATURES

- Small 8 Pin DIP Package
- Low Drive Power Requirements (TTL/CMOS Compatible)
- No Moving Parts
- High Reliability
- Arc-Free With No Snubbing Circuits
- 3750V_{RMS} Input/Output Isolation
- FCC Compatible
- VDE Compatible
- No EMI/RFI Generation
- Machine Insertable, Wave Solderable
- Current Limiting, Surface Mount and Tape & Reel Versions Available

APPROVALS

- UL Recognized: File Number E76270
- CSA Certified: File Number LR 43639-10
- BSI Certified to:
 - BS EN 60950:1992 (BS7002:1992)
Certificate #: 7344
 - BS EN 41003:1993
Certificate #: 7344

OPTIONS / SUFFIXES

- P: Flatpack Package
- S: Surface Mount Package
- TR: Tape & Reel

Switching Characteristics of Normally Open (Form A) Devices

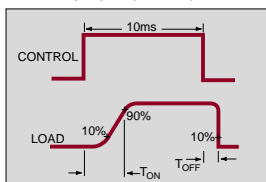

APPLICATIONS

- Telecommunications
 - Telecom Switching
 - Tip/Ring Circuits
 - Modem Switching (Laptop, Notebook, Pocket Size)
 - Hookswitch
 - Dial Pulsing
 - Ground Start
 - Ringer Injection
- Instrumentation
 - Multiplexers
 - Data Acquisition
 - Electronic Switching
 - I/O Subsystems
 - Meters (Watt-Hour, Water, Gas)
 - Medical Equipment-Patient/Equipment Isolation
- Security
- Aerospace
- Industrial Controls

RATINGS (@ 25° C)

Parameter	Min	Typ	Max	Units
Input Power Dissipation	-	-	150 ¹	mW
Input Control Current	-	-	50	mA
Peak (10ms)	-	-	1	A
Reverse Input Voltage	-	-	5	V
Total Power Dissipation	-	-	800 ²	mW
Capacitance				
Input to Output	-	3	-	pF
Isolation Voltage				
Input to Output	3750	-	-	V _{RMS}
Operational Temperature	-40	-	+85	°C
Storage Temperature	-40	-	+125	°C
Soldering Temperature				
(10 Seconds Max.)				
DIP Package	-	-	+260	°C
Flatpack/Surface Mount Package	-	-	+220	°C

¹ Derate Linearly 1.33 mW/°C

² Derate Linearly 1.67 mW/°C

Note: For Mechanical Dimensions See Pages 396-401

SPECIFICATIONS

PARAMETERS	CONDITIONS	SYMBOL	MIN	TYP	MAX	UNITS
Output Characteristics @ 25°C						
Load Voltage (Peak)	-	V_L	-	-	250	V
Load Current (Continuous) AC/DC Configuration	-	I_L	-	-	170	mA
Peak Load Current	10ms max	I_{LPK}	-	-	400	mA
On-Resistance AC/DC Configuration	$I_L=170mA$	R_{ON}	-	10	15	Ω
Off-State Leakage Current	$V_L=250V$	I_{LEAK}	-	-	1	μA
Switching Speeds						
Turn-On	$I_F=5mA, V_L=10V$	T_{ON}	-	-	5	ms
Turn-Off	$I_F=5mA, V_L=10V$	T_{OFF}	-	-	5	ms
Output Capacitance	50V; f=1MHz	C_{OUT}	-	50	-	pF
Load Current Limiting		I_{CL}	-	-	-	mA
Input Characteristics @ 25°C						
Input Control Current	$I_L=170mA$	I_F	5	-	50	mA
Input Dropout Current	-	-	0.4	0.7	-	mA
Input Voltage Drop	$I_F=5mA$	V_F	0.9	1.2	1.4	V
Reverse Input Voltage	-	V_R	-	-	5	V
Reverse Input Current	$V_R=5V$	I_R	-	-	10	μ
Input to Output Capacitance	-	$C_{I/O}$	-	3	-	pF
Input to Output Isolation	-	$V_{I/O}$	3750	-	-	V_{RMS}

LAA126 Pinout

AC/DC Configuration

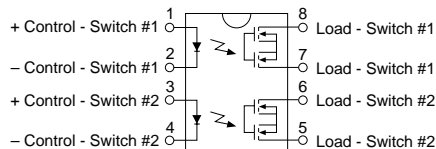

Note: For Mechanical Dimensions See Pages 396-401

PERFORMANCE DATA

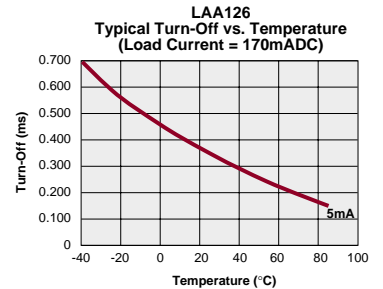
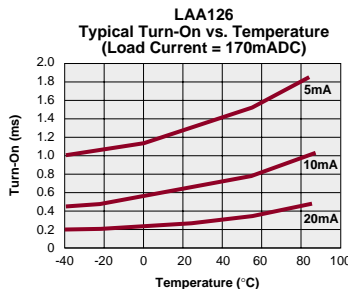
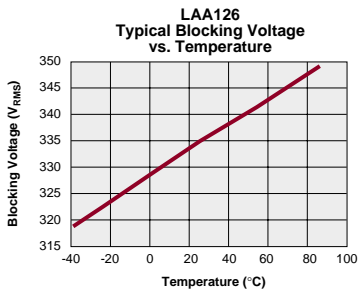
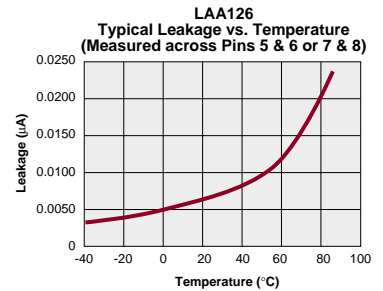
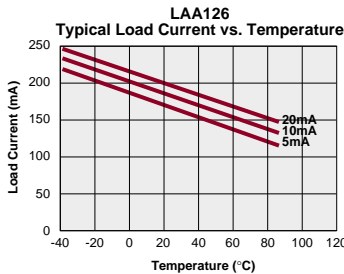
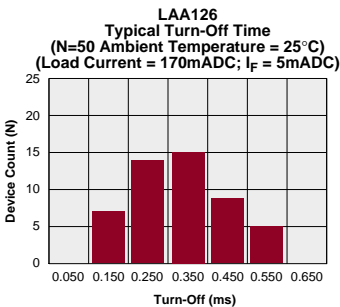
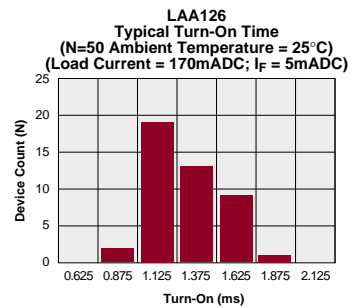
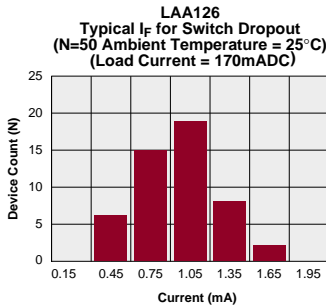
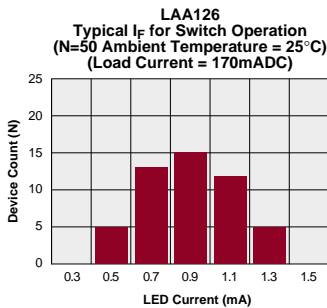
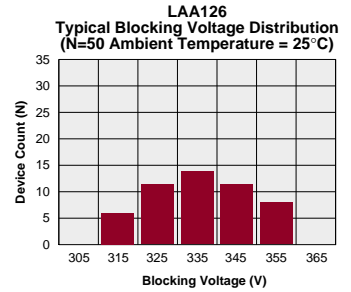
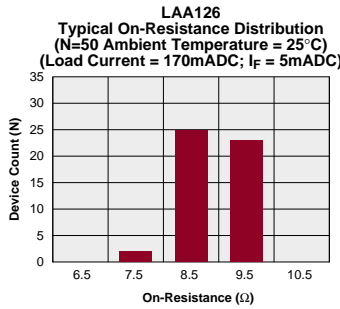
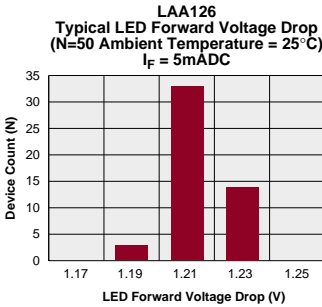

LAA126

PERFORMANCE DATA

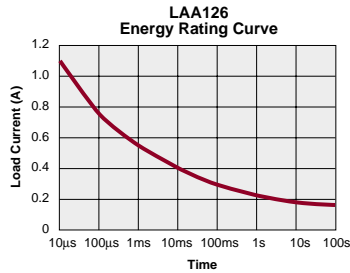
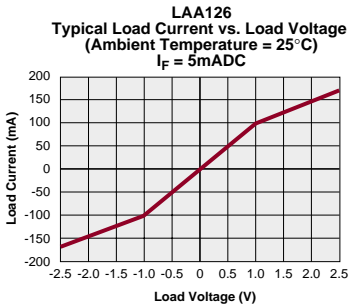
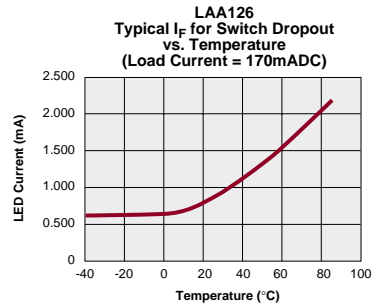
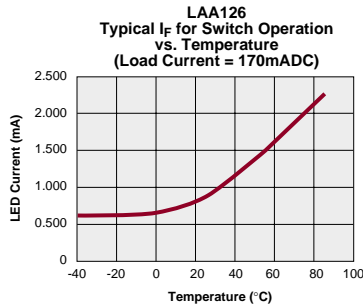
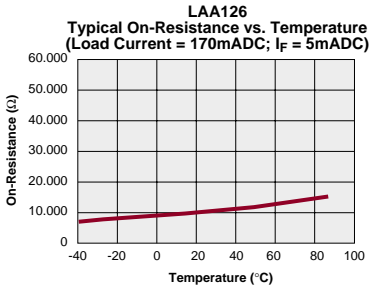
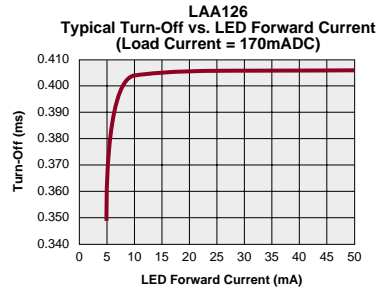
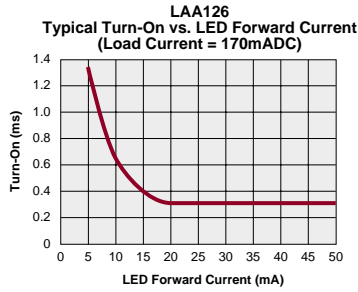
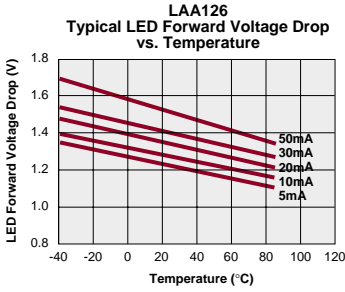



DESCRIPTION

The LAA127 is a 250V, 200mA, 10Ω type 2-Form-A solid state relay. Current limiting version available ("L" suffix).

FEATURES

- Small 8 Pin DIP Package
- Low Drive Power Requirements (TTL/CMOS Compatible)
- No Moving Parts
- High Reliability
- Arc-Free With No Snubbing Circuits
- 3750V_{RMS} Input/Output Isolation
- FCC Compatible
- VDE Compatible
- No EMI/RFI Generation
- Machine Insertable, Wave Solderable
- Current Limiting, Surface Mount and Tape & Reel Versions Available

APPROVALS

- UL Recognized: File Number E76270
- CSA Certified: File Number LR 43639-10
- BSI Certified to:
 - BS EN 60950:1992 (BS7002:1992)
Certificate #: 7344
 - BS EN 41003:1993
Certificate #: 7344

OPTIONS / SUFFIXES

- P: Flatpack Package
- L: Current Limiting
- S: Surface Mount Package
- TR: Tape & Reel

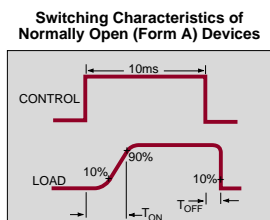

APPLICATIONS

- Telecommunications
 - Telecom Switching
 - Tip/Ring Circuits
 - Modem Switching (Laptop, Notebook, Pocket Size)
 - Hookswitch
 - Dial Pulsing
 - Ground Start
 - Ringer Injection
- Instrumentation
 - Multiplexers
 - Data Acquisition
 - Electronic Switching
 - I/O Subsystems
 - Meters (Watt-Hour, Water, Gas)
 - Medical Equipment-Patient/Equipment Isolation
- Security
- Aerospace
- Industrial Controls

RATINGS (@ 25° C)

Parameter	Min	Typ	Max	Units
Input Power Dissipation	-	-	150 ¹	mW
Input Control Current	-	-	50	mA
Peak (10ms)	-	-	1	A
Reverse Input Voltage	-	-	5	V
Total Power Dissipation	-	-	800 ²	mW
Capacitance				
Input to Output	-	3	-	pF
Isolation Voltage				
Input to Output	3750	-	-	V _{RMS}
Operational Temperature	-40	-	+85	°C
Storage Temperature	-40	-	+125	°C
Soldering Temperature (10 Seconds Max.)				
DIP Package	-	-	+260	°C
Flatpack/Surface Mount Package	-	-	+220	°C

¹ Derate Linearly 1.33 mw/°C
² Derate Linearly 1.67 mw/°C

Note: For Mechanical Dimensions See Pages 396-401

SPECIFICATIONS

LAA127

LAA127L

PARAMETERS	CONDITIONS	SYMBOL	MIN	TYP	MAX	MIN	TYP	MAX	UNITS
Output Characteristics @ 25°C									
Load Voltage (Peak)	-	V_L	-	-	250	-	-	250	V
Load Current (Continuous) AC/DC Configuration	-	I_L	-	-	200	-	-	170	mA
Peak Load Current	10ms max	I_{LPK}	-	-	400	-	-	-	mA
On-Resistance AC/DC Configuration	I_L =Load Current	R_{ON}	-	8	10	-	13	15	Ω
Off-State Leakage Current	V_L =250V	I_{LEAK}	-	-	1	-	-	1	μ A
Switching Speeds									
Turn-On	I_F =5mA, V_L =10V	T_{ON}	-	-	5	-	-	5	ms
Turn-Off	I_F =5mA, V_L =10V	T_{OFF}	-	-	5	-	-	5	ms
Output Capacitance	50V; f=1MHz	C_{OUT}	-	110	-	-	110	-	pF
Load Current Limiting		I_{CL}	-	-	-	190	235	280	mA
Input Characteristics @ 25°C									
Input Control Current	I_L =Load Current	I_F	5	-	50	5	-	50	mA
Input Dropout Current	-	-	0.4	0.7	-	0.4	0.7	-	mA
Input Voltage Drop	I_F =5mA	V_F	0.9	1.2	1.4	0.9	1.2	1.4	V
Reverse Input Voltage	-	V_R	-	-	5	-	-	5	V
Reverse Input Current	V_R =5V	I_R	-	-	10	-	-	10	μ A
Input to Output Capacitance	-	$C_{I/O}$	-	3	-	-	3	-	pF
Input to Output Isolation	-	$V_{I/O}$	3750	-	-	3750	-	-	V_{RMS}

LAA127 Pinout

AC/DC Configuration

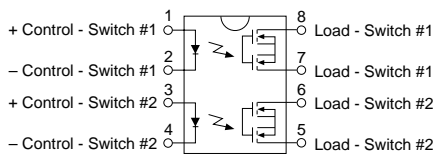

LAA127L Pinout

AC/DC Configuration

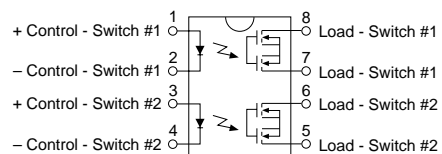

Note: For Mechanical Dimensions See Pages 396-401

PERFORMANCE DATA

LAA127
Typical LED Forward Voltage Drop
(N=50 Ambient Temperature = 25°C)
I_F = 5mADC

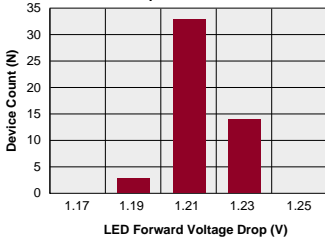

LAA127
Typical On-Resistance Distribution
(N=50 Ambient Temperature = 25°C)
(Load Current = 200mADC; I_F = 5mADC)

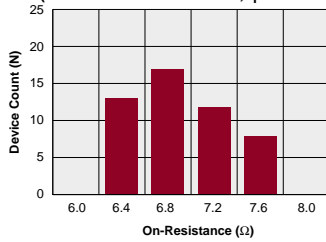

LAA127
Typical Blocking Voltage Distribution
(N=50 Ambient Temperature = 25°C)

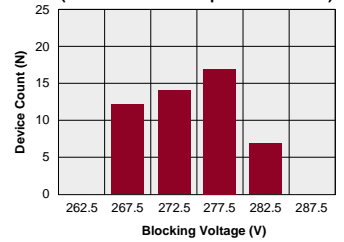

LAA127
Typical I_F for Switch Operation
(N=50 Ambient Temperature = 25°C)
(Load Current = 200mADC)

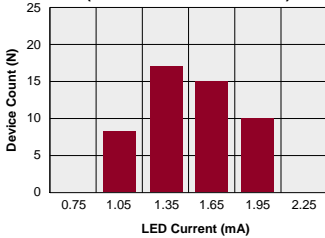

LAA127
Typical I_F for Switch Dropout
(N=50 Ambient Temperature = 25°C)
(Load Current = 200mADC)

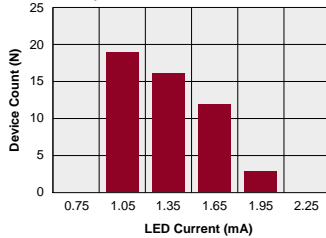

LAA127
Typical Turn-On Time
(N=50 Ambient Temperature = 25°C)
(Load Current = 200mADC; I_F = 5mADC)

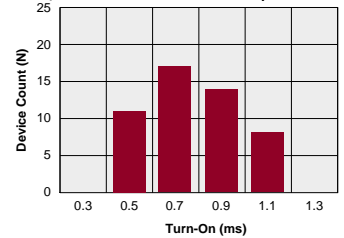

LAA127
Typical Turn-Off Time
(N=50 Ambient Temperature = 25°C)
(Load Current = 200mADC; I_F = 5mADC)

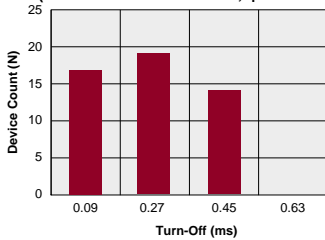

LAA127
Typical Load Current vs. Temperature

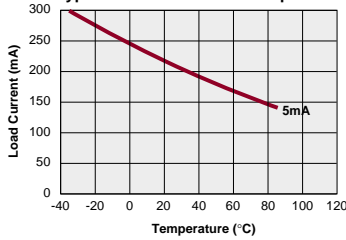

LAA127
Typical Leakage vs. Temperature
(Measured across Pins 5 & 6 or 7 & 8)

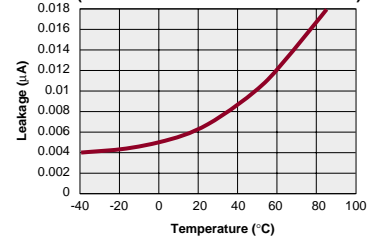

LAA127
Typical Blocking Voltage vs. Temperature

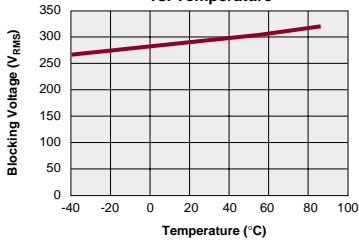

LAA127
Typical Turn-On vs. Temperature
(Load Current = 200mADC)

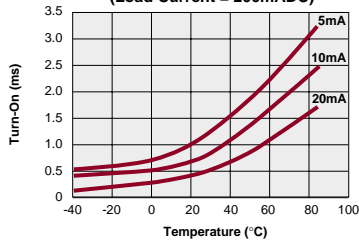

LAA127
Typical Turn-Off vs. Temperature
(Load Current = 200mADC)

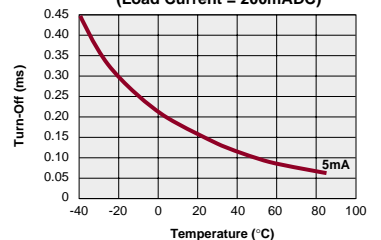

PERFORMANCE DATA

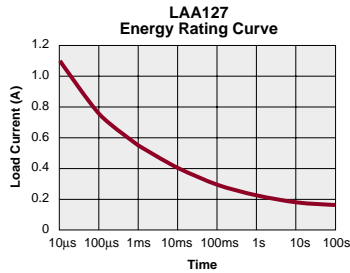
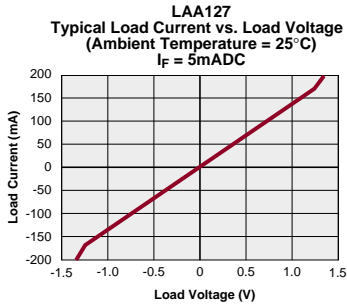
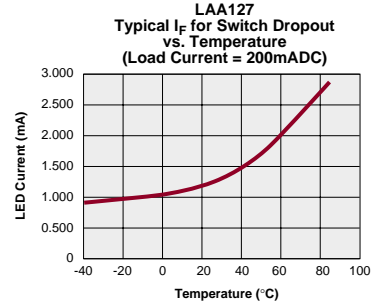
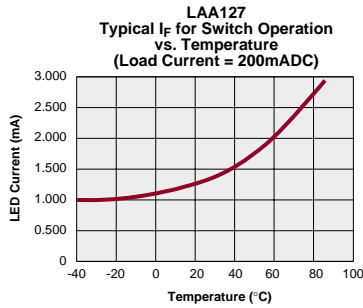
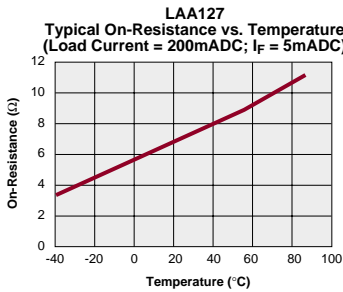
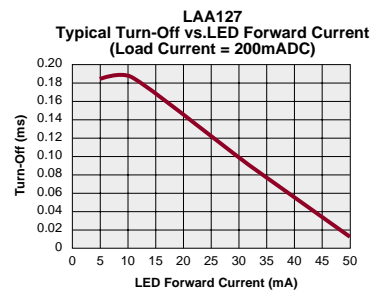
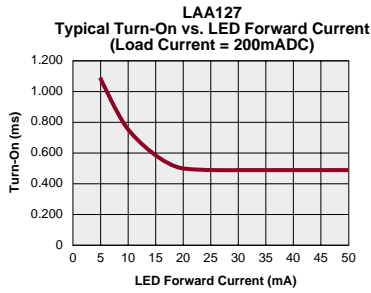
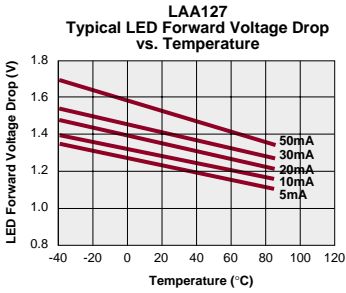

PERFORMANCE DATA

LAA127L
Typical LED Forward Voltage Drop
(N=50 Ambient Temperature = 25°C)
I_F = 5mAADC

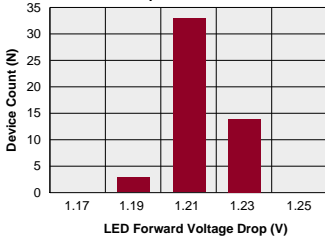

LAA127L
Typical On-Resistance Distribution
(N=50 Ambient Temperature = 25°C)
(Load Current = 170mAADC; I_F = 5mAADC)

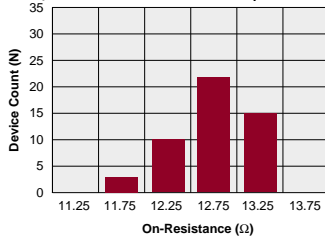

LAA127L
Typical Blocking Voltage Distribution
(N=50 Ambient Temperature = 25°C)

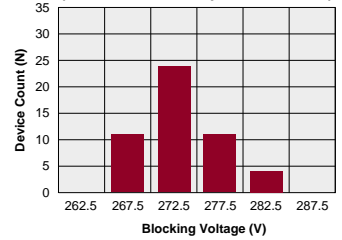

LAA127L
Typical I_F for Switch Operation
(N=50 Ambient Temperature = 25°C)
(Load Current = 170mAADC)

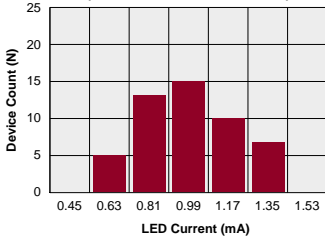

LAA127L
Typical I_F for Switch Dropout
(N=50 Ambient Temperature = 25°C)
(Load Current = 170mAADC)

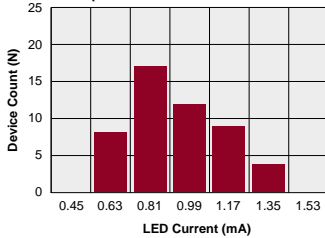

LAA127L
Typical Turn-On Time
(N=50 Ambient Temperature = 25°C)
(Load Current = 170mAADC; I_F = 5mAADC)

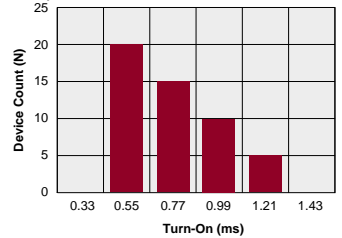

LAA127L
Typical Turn-Off Time
(N=50 Ambient Temperature = 25°C)
(Load Current = 170mAADC; I_F = 5mAADC)

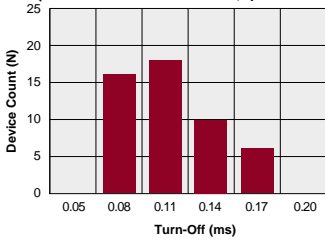

LAA127L
Typical Load Current vs. Temperature

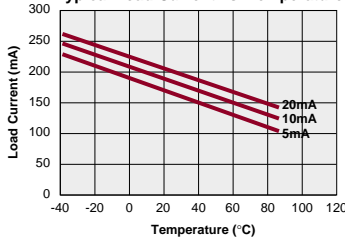

LAA127L
Typical Leakage vs. Temperature
(Measured across Pins 5 & 6 or 7 & 8)

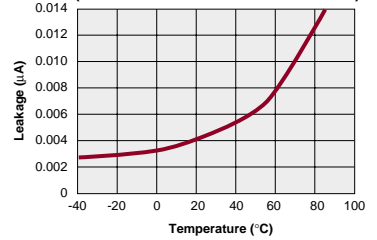

LAA127L
Typical Blocking Voltage vs. Temperature

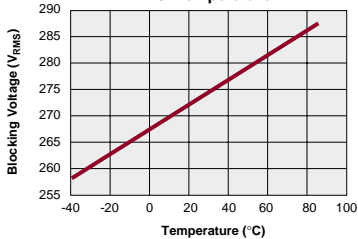

LAA127L
Typical Turn-On vs. Temperature
(Load Current = 170mAADC)

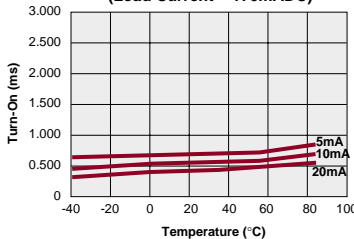

LAA127L
Typical Turn-Off vs. Temperature
(Load Current = 170mAADC)

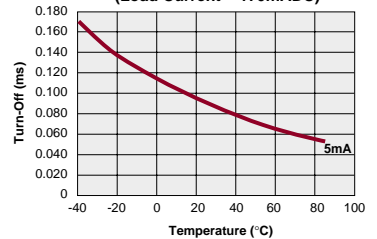

PERFORMANCE DATA

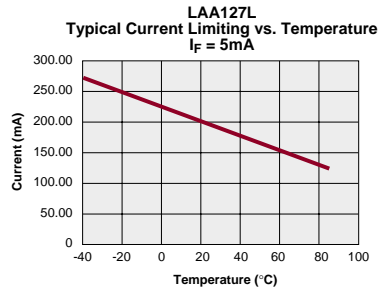
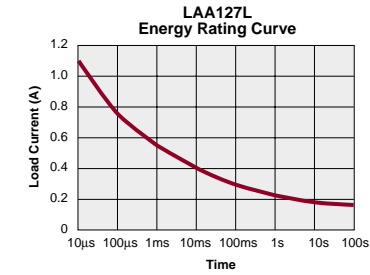
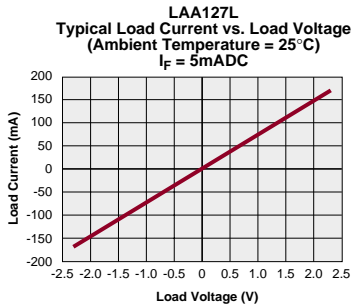
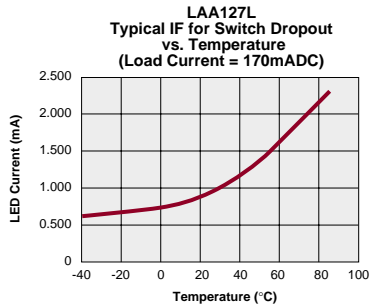
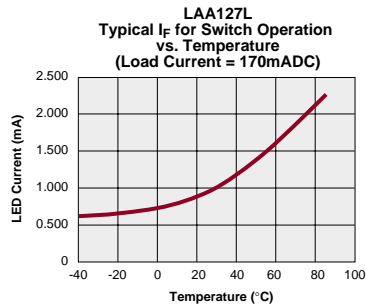
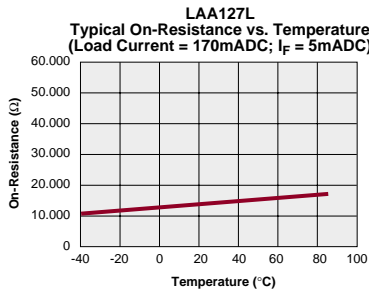
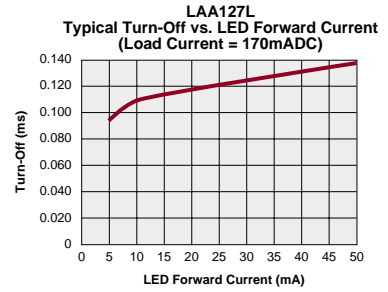
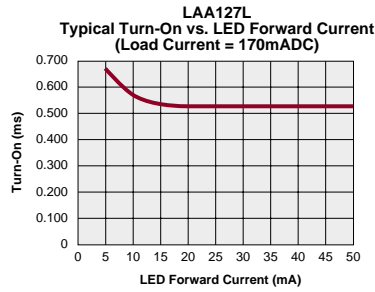
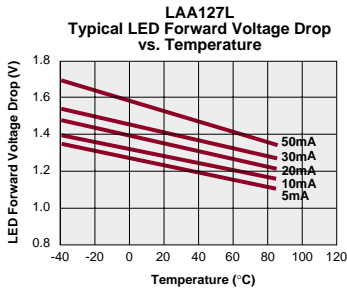



DESCRIPTION

The LBA110 is a 350V, 120mA, 35Ω independent 1-Form-A/1-Form-B solid state relay. Current limiting version available ("L" suffix).

FEATURES

- Small 8 Pin DIP Package
- Low Drive Power Requirements (TTL/CMOS Compatible)
- No Moving Parts
- High Reliability
- Arc-Free With No Snubbing Circuits
- 3750V_{RMS} Input/Output Isolation
- FCC Compatible
- VDE Compatible
- No EMI/RFI Generation
- Machine Insertable, Wave Solderable
- Current Limiting, Surface Mount and Tape & Reel Versions Available

APPROVALS

- UL Recognized: File Number E76270
- CSA Certified: File Number LR 43639-10
- BSI Certified to:
 - BS EN 60950:1992 (BS7002:1992)
Certificate #: 7344
 - BS EN 41003:1993
Certificate #: 7344

OPTIONS / SUFFIXES

- P: Flatpack Package
- L: Current Limiting
- S: Surface Mount Package
- TR: Tape & Reel

APPLICATIONS

- Telecommunications
 - Telecom Switching
 - Tip/Ring Circuits
 - Modem Switching (Laptop, Notebook, Pocket Size)
 - Hookswitch
 - Dial Pulsing
 - Ground Start
 - Ringer Injection
- Instrumentation
 - Multiplexers
 - Data Acquisition
 - Electronic Switching
 - I/O Subsystems
 - Meters (Watt-Hour, Water, Gas)
- Medical Equipment-Patient/Equipment Isolation
- Security
- Aerospace
- Industrial Controls

RATINGS (@ 25°C)

Parameter	Min	Typ	Max	Units
Input Power Dissipation	-	-	150 ¹	mW
Input Control Current	-	-	50	mA
Peak (10ms)	-	-	1	A
Reverse Input Voltage	-	-	5	V
Total Power Dissipation	-	-	800 ²	mW
Capacitance				
Input to Output	-	3	-	pF
Isolation Voltage				
Input to Output	3750	-	-	V _{RMS}
Operational Temperature	-40	-	+85	°C
Storage Temperature	-40	-	+125	°C
Soldering Temperature (10 Seconds Max.)				
DIP Package	-	-	+260	°C
Flatpack/Surface Mount Package	-	-	+220	°C

¹ Derate Linearly 1.33 mW/°C

² Derate Linearly 1.67 mW/°C

Switching Characteristics of Normally Open (Form A) Devices

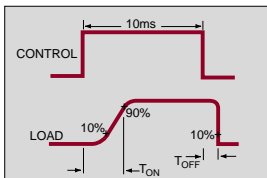

Switching Characteristics of Normally Closed (Form B) Devices

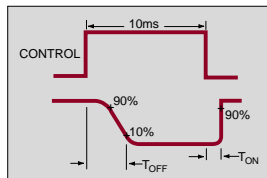

Note: For Mechanical Dimensions See Pages 396-401

SPECIFICATIONS

PARAMETERS	CONDITIONS	SYMBOL	LBA110			LBA110L			UNITS
			MIN	TYP	MAX	MIN	TYP	MAX	
Output Characteristics @ 25°C									
Load Voltage (Peak)	-	V_L	-	-	350	-	-	350	V
Load Current *(Continuous) AC/DC Configuration	-	I_L	-	-	120	-	-	120	mA
Peak Load Current	10ms	I_{LPK}	-	-	350	-	-	-	mA
On-Resistance AC/DC Configuration	$I_L=120mA$	R_{ON}	-	23	35	-	23	35	Ω
Off-State Leakage Current	$V_L=350V$	I_{LEAK}	-	-	1	-	-	1	μA
Switching Speeds									
Turn-On	$I_F=5mA, V_L=10V$	T_{ON}	-	-	3	-	-	3	ms
Turn-Off	$I_F=5mA, V_L=10V$	T_{OFF}	-	-	3	-	-	3	ms
Output Capacitance	50V; f=1MHz	C_{OUT}	-	25	-	-	25	-	pF
Load Current Limiting	Form A only	I_{CL}	-	-	-	130	170	210	mA
Input Characteristics @ 25°C									
Input Control Current	$I_L=Load\ Current$	I_F	5	-	50	5	-	50	mA
Input Dropout Current	-	I_F	0.4	0.7	-	0.4	0.7	-	mA
Input Voltage Drop	$I_F=5mA$	V_F	0.9	1.2	1.4	0.9	1.2	1.4	V
Reverse Input Voltage	-	V_R	-	-	5	-	-	5	V
Reverse Input Current	$V_R=5V$	I_R	-	-	10	-	-	10	μA
Input to Output Capacitance	-	$C_{I/O}$	-	3	-	-	3	-	pF
Input to Output Isolation	-	$V_{I/O}$	3750	-	-	3750	-	-	V_{RMS}

*NOTE: If both poles operate simultaneously load current must be derated so as not to exceed the package power dissipation value.

LBA110 Pinout

AC/DC Configuration

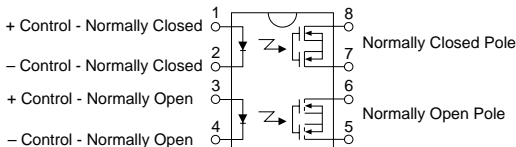

LBA110L Pinout

AC/DC Configuration

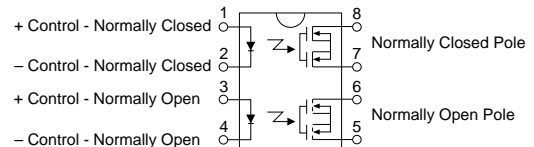

Note: For Mechanical Dimensions See Pages 396-401

PERFORMANCE DATA

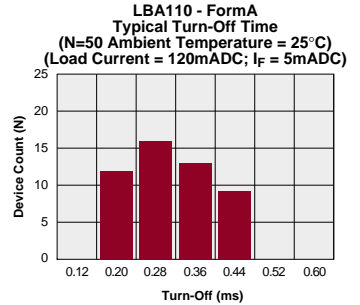
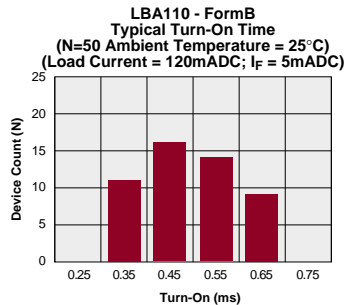
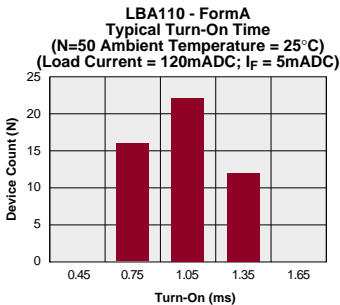
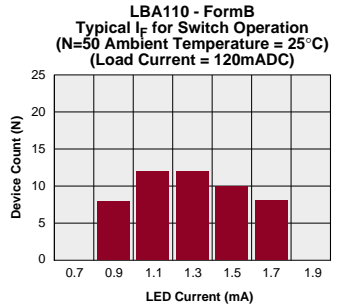
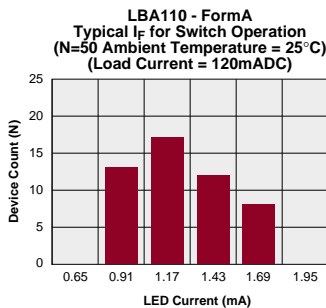
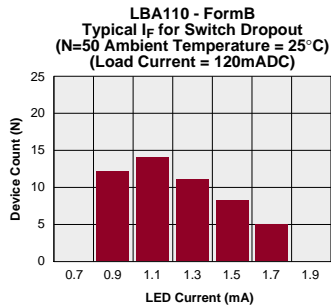
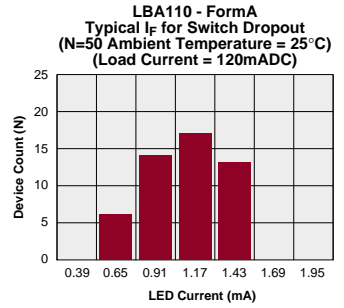
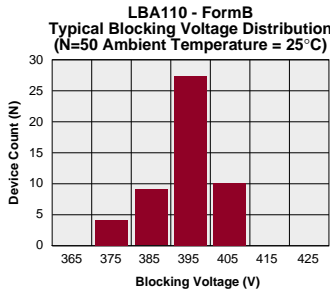
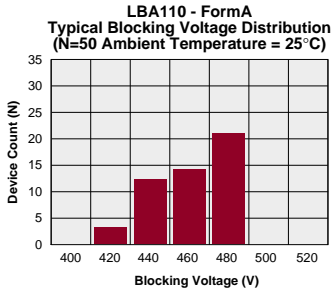
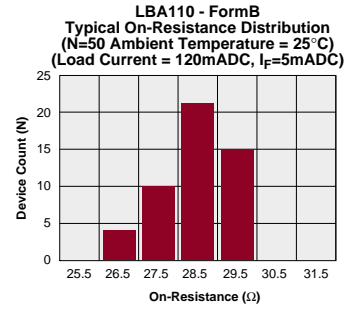
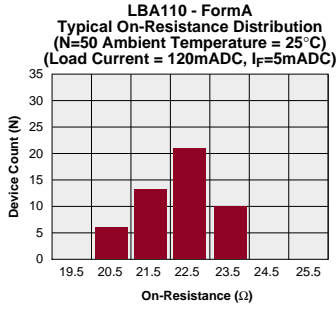
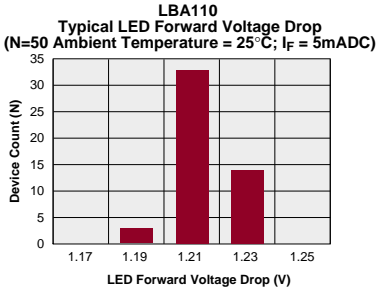

LBA110/LBA110L

PERFORMANCE DATA

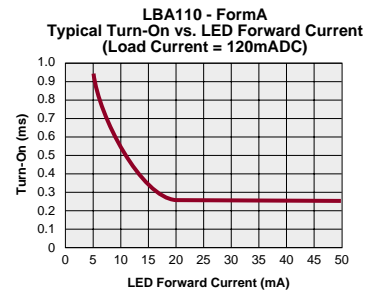
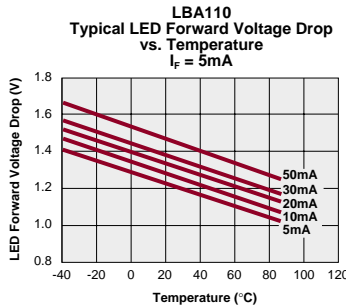
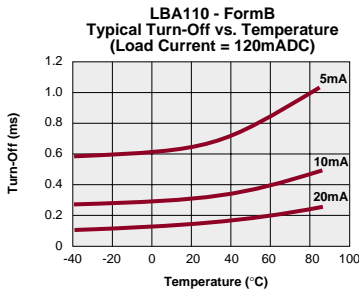
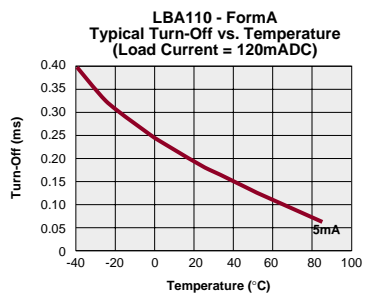
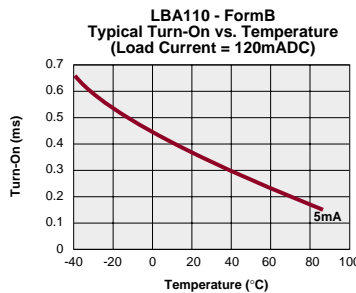
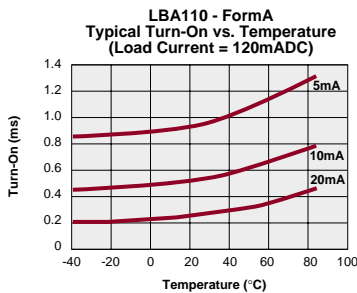
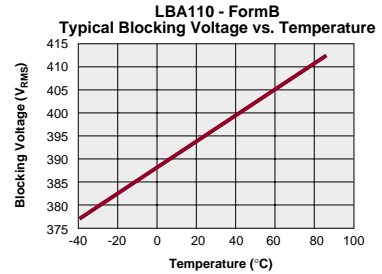
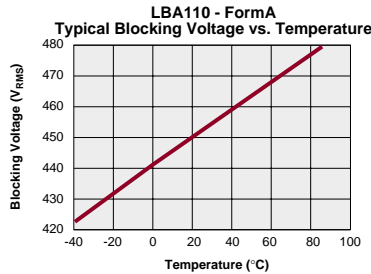
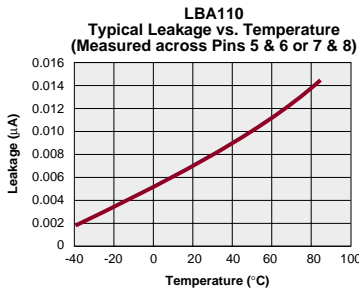
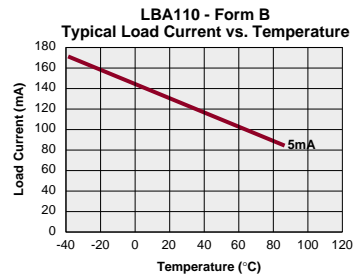
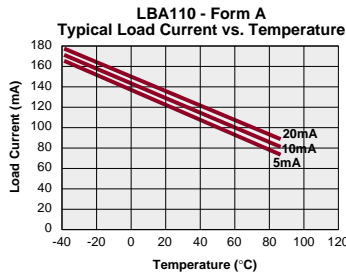
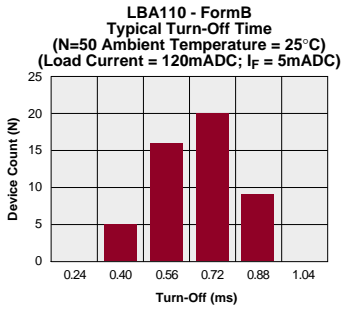

PERFORMANCE DATA

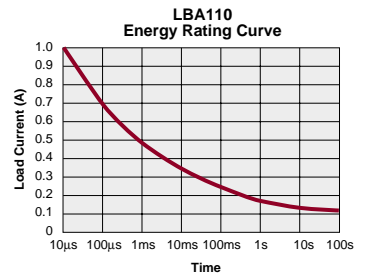
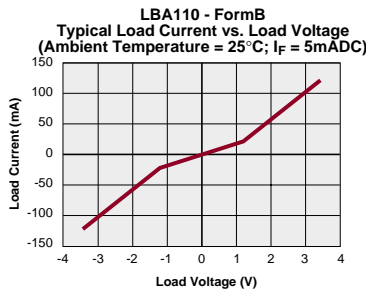
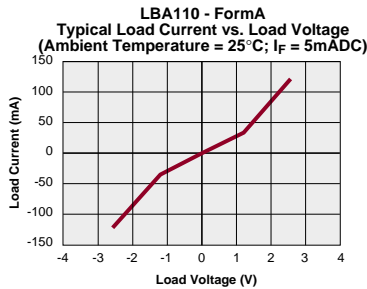
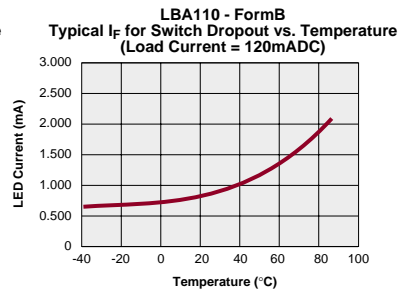
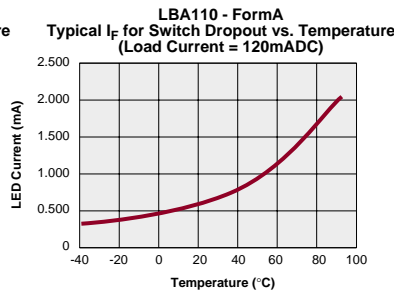
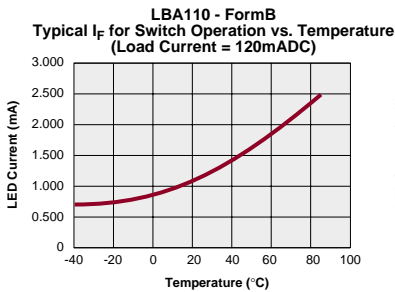
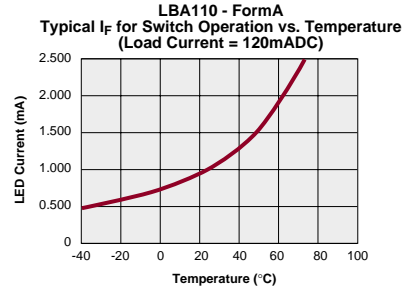
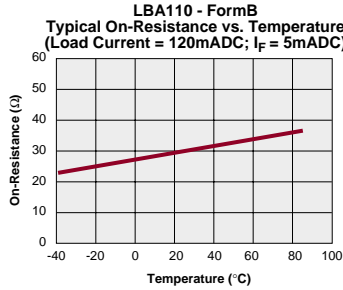
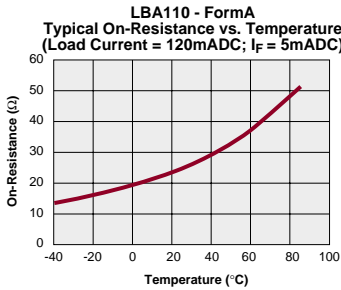
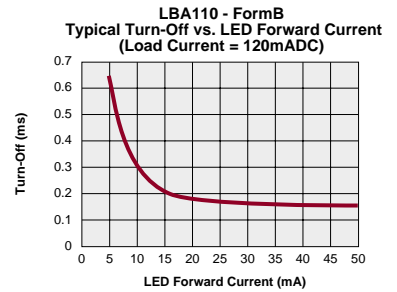
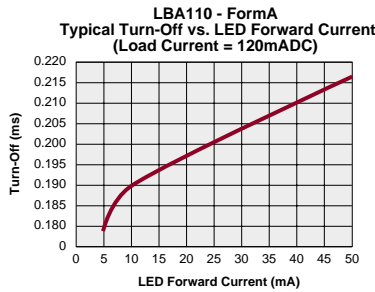
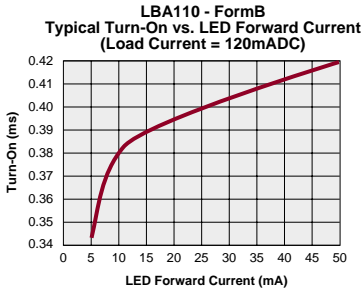

LBA110/LBA110L

PERFORMANCE DATA

LBA110L
Typical LED Forward Voltage Drop
(N=50 Ambient Temperature = 25°C; I_F = 5mADC)

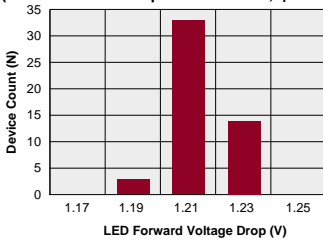

LBA110L - FormA
Typical On-Resistance Distribution
(N=50 Ambient Temperature = 25°C)
(Load Current = 120mADC, I_F=5mADC)

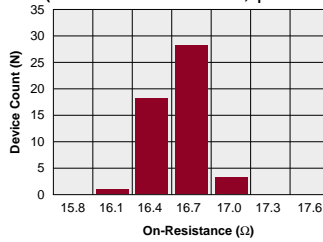

LBA110L - FormB
Typical On-Resistance Distribution
(N=50 Ambient Temperature = 25°C)
(Load Current = 120mADC, I_F=5mADC)

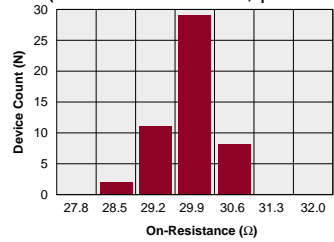

LBA110L - FormA
Typical Blocking Voltage Distribution
(N=50 Ambient Temperature = 25°C)

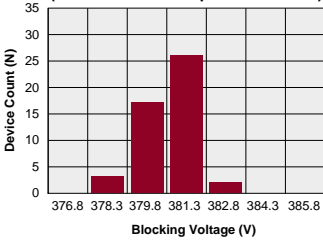

LBA110L - FormB
Typical Blocking Voltage Distribution
(N=50 Ambient Temperature = 25°C)

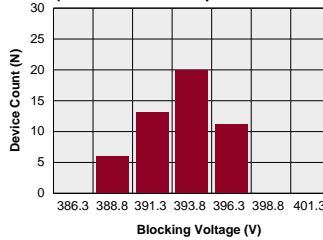

LBA110L - FormA
Typical I_F for Switch Operation
(N=50 Ambient Temperature = 25°C)
(Load Current = 120mADC)

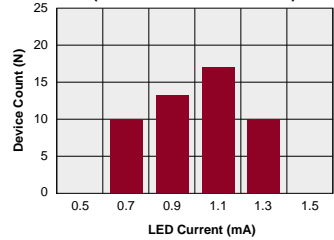

LBA110L - FormB
Typical I_F for Switch Operation
(N=50 Ambient Temperature = 25°C)
(Load Current = 120mADC)

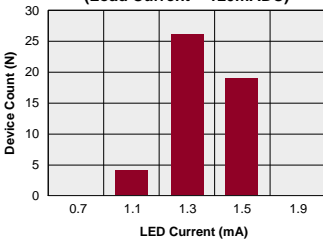

LBA110L - FormA
Typical I_F for Switch Dropout
(N=50 Ambient Temperature = 25°C)
(Load Current = 120mADC)

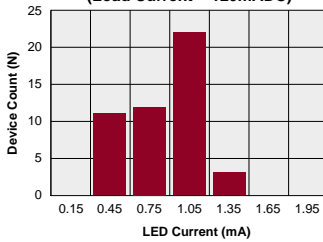

LBA110L - FormB
Typical I_F for Switch Dropout
(N=50 Ambient Temperature = 25°C)
(Load Current = 120mADC)

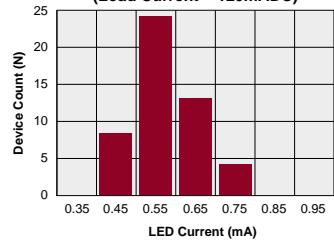

LBA110L - FormA
Typical Turn-On Time
(N=50 Ambient Temperature = 25°C)
(Load Current = 120mADC; I_F = 5mADC)

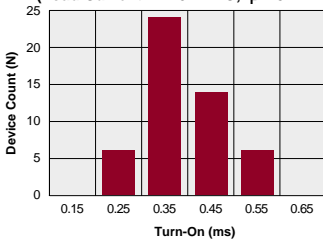

LBA110L - FormB
Typical Turn-On Time
(N=50 Ambient Temperature = 25°C)
(Load Current = 120mADC; I_F = 5mADC)

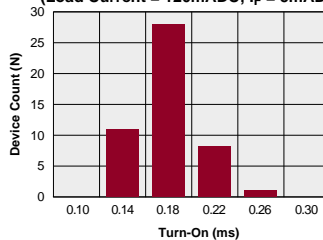

LBA110L - FormA
Typical Turn-Off Time
(N=50 Ambient Temperature = 25°C)
(Load Current = 120mADC; I_F = 5mADC)

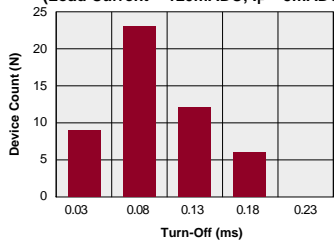

PERFORMANCE DATA

LBA110L - FormB
Typical Turn-Off Time
(N=50 Ambient Temperature = 25°C)
(Load Current = 120mADC; I_F = 5mADC)

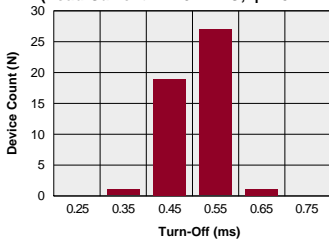

LBA110L - Form A
Typical Load Current vs. Temperature

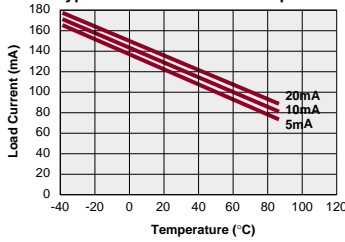

LBA110L - Form B
Typical Load Current vs. Temperature

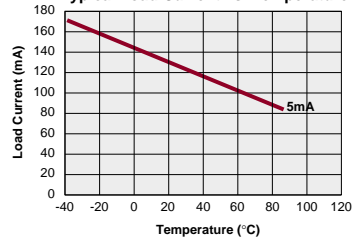

LBA110L
Typical Leakage vs. Temperature
(Measured across Pins 5 & 6 or 7 & 8)

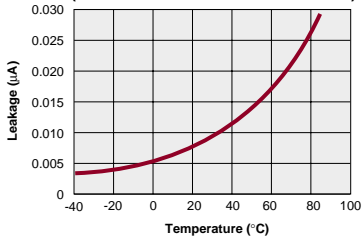

LBA110L - FormA
Typical Blocking Voltage vs. Temperature

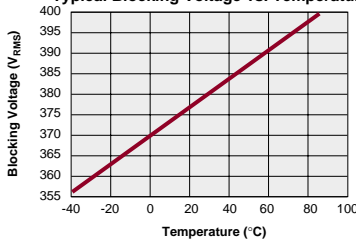

LBA110L - FormB
Typical Blocking Voltage vs. Temperature

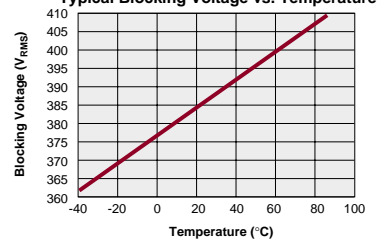

LBA110L - FormA
Typical Turn-On vs. Temperature
(Load Current = 120mADC)

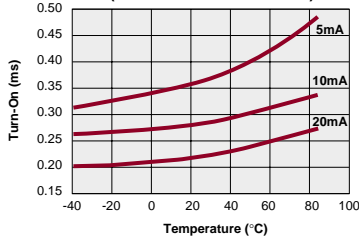

LBA110L - FormB
Typical Turn-On vs. Temperature
(Load Current = 120mADC)

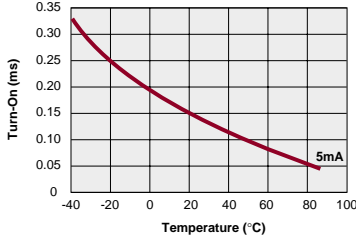

LBA110L - FormA
Typical Turn-Off vs. Temperature
(Load Current = 120mADC)

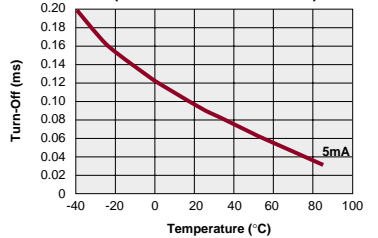

LBA110L - FormB
Typical Turn-Off vs. Temperature
(Load Current = 120mADC)

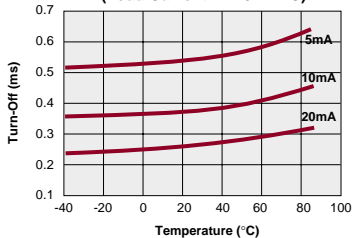

LBA110L
Typical LED Forward Voltage Drop vs. Temperature

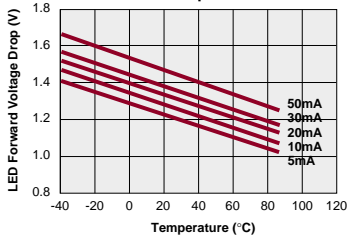

LBA110L - FormA
Typical Turn-On vs. LED Forward Current
(Load Current = 120mADC)

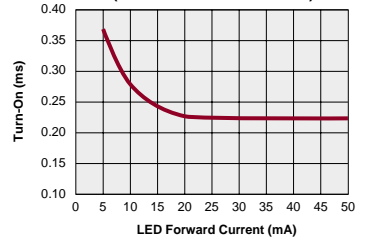

LBA110/LBA110L

PERFORMANCE DATA

LBA110L - FormB
Typical Turn-On vs. LED Forward Current
(Load Current = 120mADC)

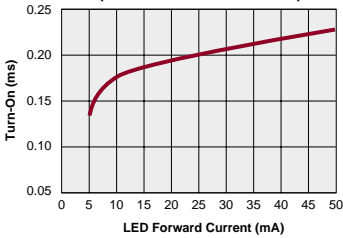

LBA110L - FormA
Typical Turn-Off vs. LED Forward Current
(Load Current = 120mADC)

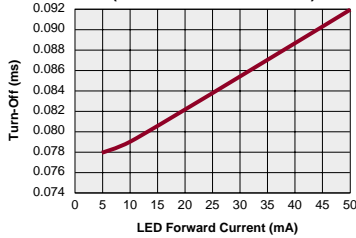

LBA110L - FormB
Typical Turn-Off vs. LED Forward Current
(Load Current = 120mADC)

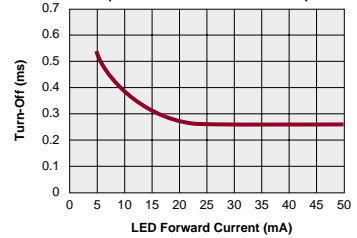

LBA110L - FormA
Typical On-Resistance vs. Temperature
(Load Current = 120mADC; $I_F = 5\text{mADC}$)

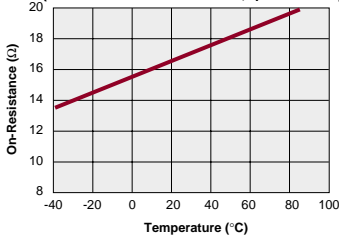

LBA110L - FormB
Typical On-Resistance vs. Temperature
(Load Current = 120mADC; $I_F = 5\text{mADC}$)

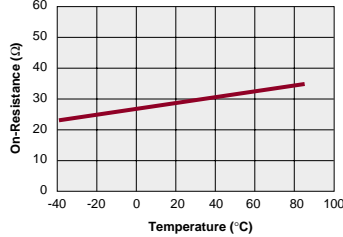

LBA110L - FormA
Typical I_F for Switch Operation vs. Temperature
(Load Current = 120mADC)

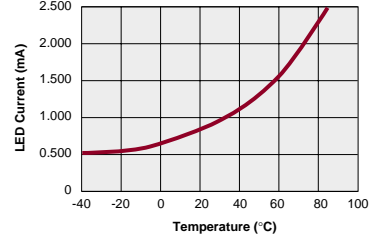

LBA110L - FormB
Typical I_F for Switch Operation vs. Temperature
(Load Current = 120mADC)

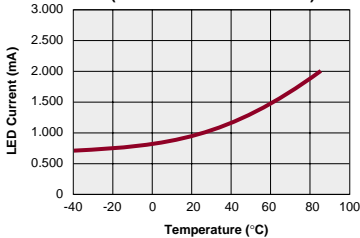

LBA110L - FormA
Typical I_F for Switch Dropout vs. Temperature
(Load Current = 120mADC)

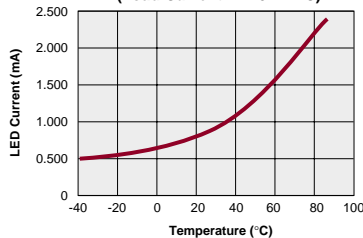

LBA110L - FormB
Typical I_F for Switch Dropout vs. Temperature
(Load Current = 120mADC)

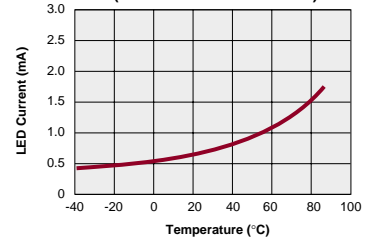

LBA110L - FormA
Typical Load Current vs. Load Voltage
(Ambient Temperature = 25°C; $I_F = 5\text{mADC}$)

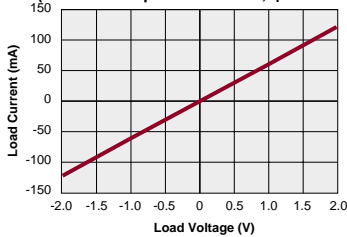

LBA110L - FormB
Typical Load Current vs. Load Voltage
(Ambient Temperature = 25°C; $I_F = 5\text{mADC}$)

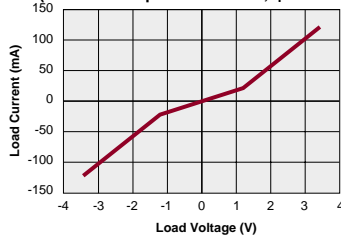

LBA110L
Energy Rating Curve

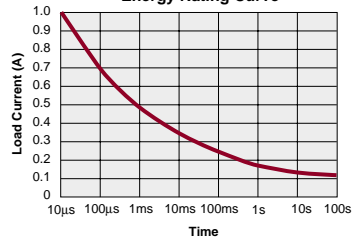

PERFORMANCE DATA

LBA110L
Typical Current Limiting Characteristics
vs. Temperature
 $I_F = 5\text{mA}$

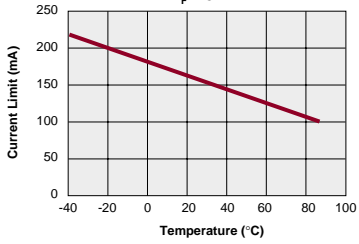

XBA170



DESCRIPTION

The XBA170 is a 350V, 120mA, 50Ω independent 1-Form-A/1-Form-B solid state relay.

FEATURES

- Small 8 Pin DIP Package
- Low Drive Power Requirements (TTL/CMOS Compatible)
- No Moving Parts
- High Reliability
- Arc-Free With No Snubbing Circuits
- 3750V_{RMS} Input/Output Isolation
- FCC Compatible
- VDE Compatible
- No EMI/RFI Generation
- Machine Insertable, Wave Solderable
- Surface Mount and Tape & Reel Versions Available

APPROVALS

- UL Recognized: File Number E76270
- CSA Certified: File Number LR 43639-10
- BSI Certified to:
 - BS EN 60950:1992 (BS7002:1992) Certificate #: 7344
 - BS EN 41003:1993 Certificate #: 7344

OPTIONS / SUFFIXES

- P: Flatpack Package
- S: Surface Mount Package
- TR: Tape & Reel

Switching Characteristics of Normally Open (Form A) Devices

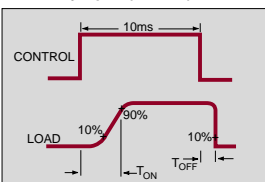

Switching Characteristics of Normally Closed (Form B) Devices

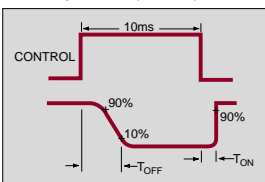

APPLICATIONS

- Telecommunications
 - Telecom Switching
 - Tip/Ring Circuits
 - Modem Switching (Laptop, Notebook, Pocket Size)
 - Hookswitch
 - Dial Pulsing
 - Ground Start
 - Ringer Injection
- Instrumentation
 - Multiplexers
 - Data Acquisition
 - Electronic Switching
 - I/O Subsystems
 - Meters (Watt-Hour, Water, Gas)
- Medical Equipment—Patient/Equipment Isolation
- Security
- Aerospace
- Industrial Controls

RATINGS (@ 25° C)

Parameter	Min	Typ	Max	Units
Input Power Dissipation	-	-	150 ¹	mW
Input Control Current	-	-	50	mA
Peak (10ms)	-	-	1	A
Reverse Input Voltage	-	-	5	V
Total Power Dissipation	-	-	800 ²	mW
Capacitance				
Input to Output	-	3	-	pF
Isolation Voltage				
Input to Output	3750	-	-	V _{RMS}
Operational Temperature	-40	-	+85	°C
Storage Temperature	-40	-	+125	°C
Soldering Temperature (10 Seconds Max.)				
DIP Package	-	-	+260	°C
Flatpack/Surface Mount Package	-	-	+220	°C

¹ Derate Linearly 1.33 mw/°C

² Derate Linearly 1.67 mw/°C

Note: For Mechanical Dimensions See Pages 396-401

SPECIFICATIONS

PARAMETERS	CONDITIONS	SYMBOL	MIN	TYP	MAX	UNITS
Output Characteristics @ 25°C						
Load Voltage (Peak)	-	V_L	-	-	350	V
Load Current* (Continuous) AC/DC Configuration	-	I_L	-	-	100	mA
Peak Load Current	10ms	I_{LPK}	-	-	350	mA
On-Resistance AC/DC Configuration	$I_L=120mA$	R_{ON}	-	33	50	Ω
Off-State Leakage Current	$V_L=350V$	I_{LEAK}	-	-	1	μA
Switching Speeds						
Turn-On	$I_F=5mA, V_L=10V$	T_{ON}	1	-	5	ms
Turn-Off	$I_F=5mA, V_L=10V$	T_{OFF}	1	-	5	ms
Output Capacitance	50V; f=1MHz	C_{OUT}	-	25	-	pF
Input Characteristics @ 25°C						
Input Control Current	$I_L=$ Load Current	I_F	5	-	50	mA
Input Dropout Current	-	I_F	0.4	0.7	-	mA
Input Voltage Drop	$I_F=5mA$	V_F	0.9	1.2	1.4	V
Reverse Input Voltage	-	V_R	-	-	5	V
Reverse Input Current	$V_R=5V$	I_R	-	-	10	μA
Input to Output Capacitance	-	$C_{I/O}$	-	3	-	pF
Input to Output Isolation	-	$V_{I/O}$	3750	-	-	V_{RMS}

XBA170 Pinout

AC/DC Configuration

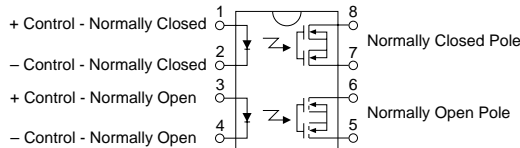

Note: For Mechanical Dimensions See Pages 396-401

www.cpcclare.com

XBA170

PERFORMANCE DATA

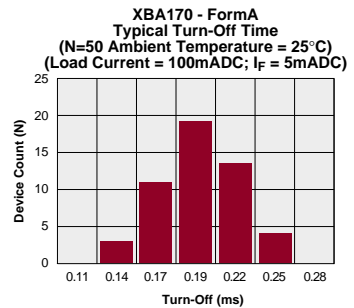
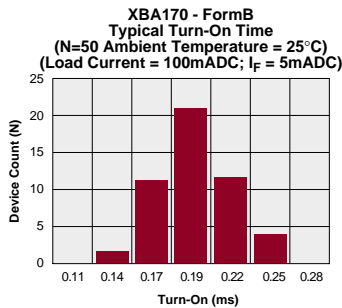
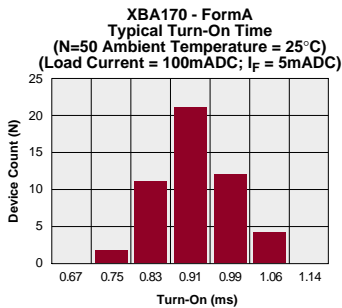
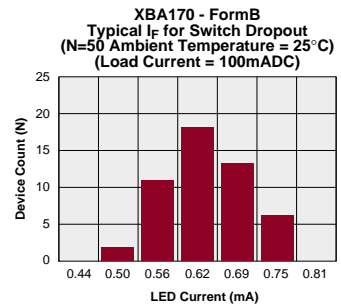
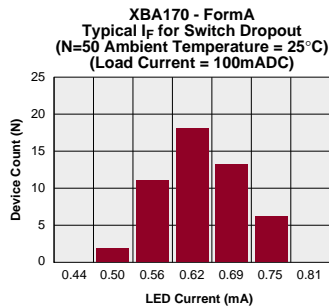
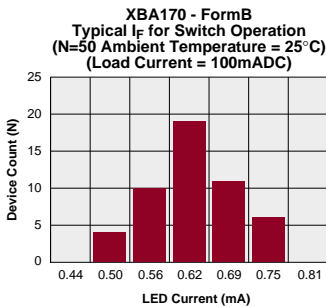
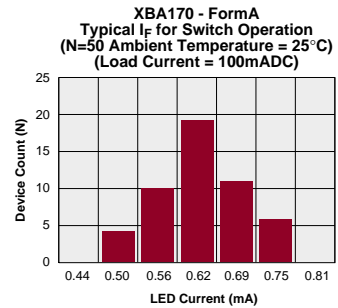
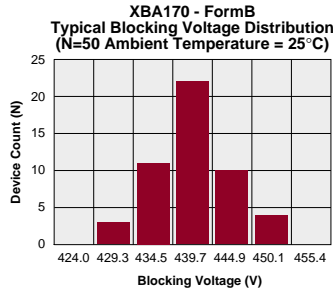
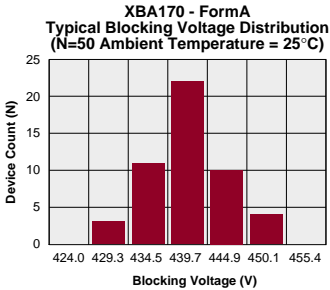
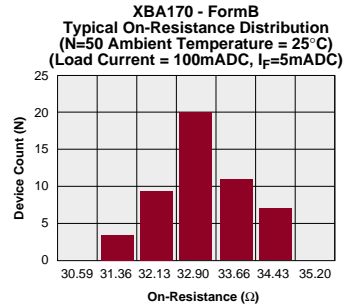
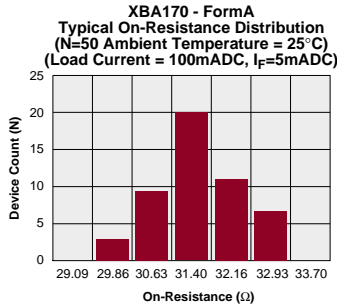
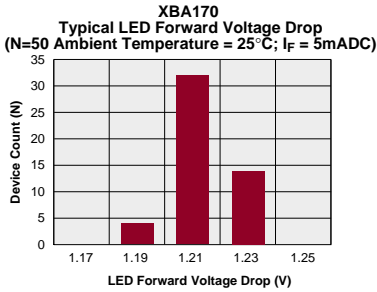

PERFORMANCE DATA

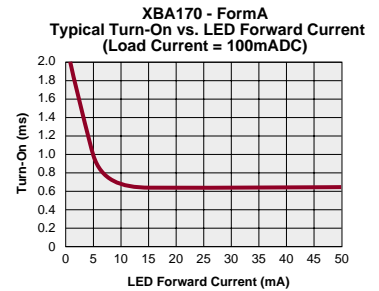
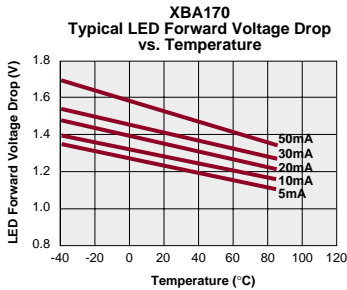
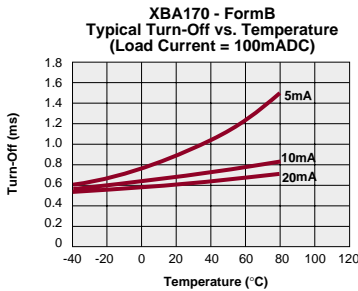
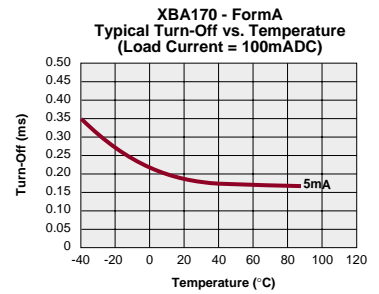
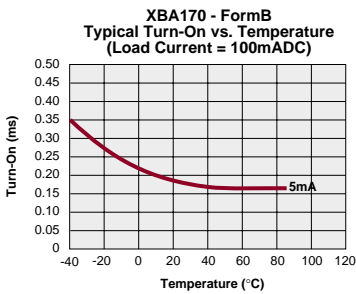
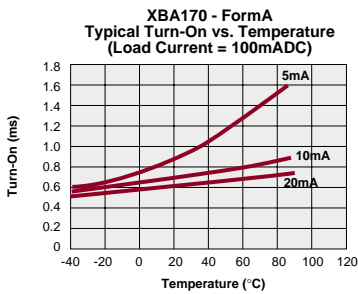
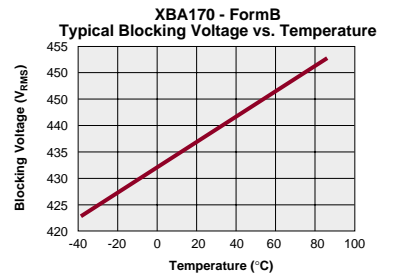
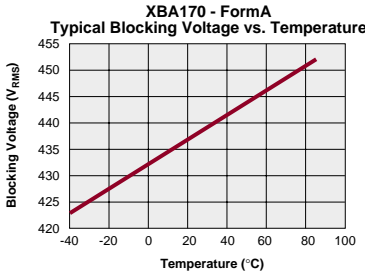
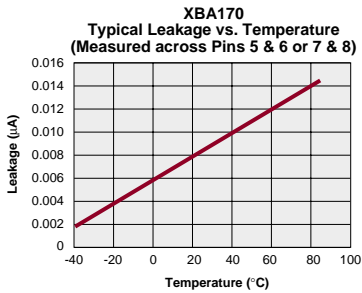
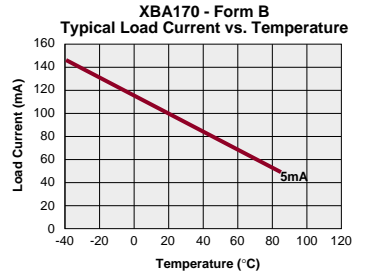
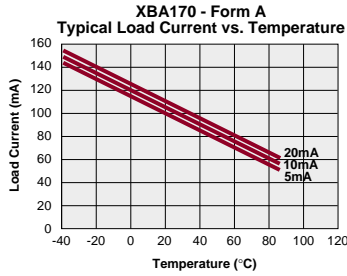
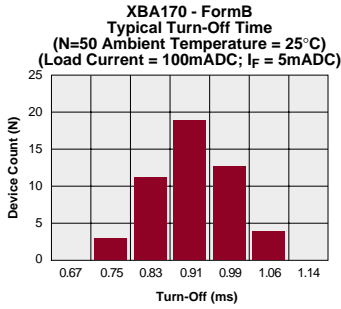

XBA170

PERFORMANCE DATA

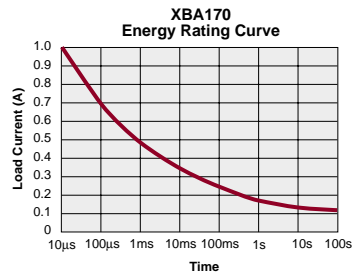
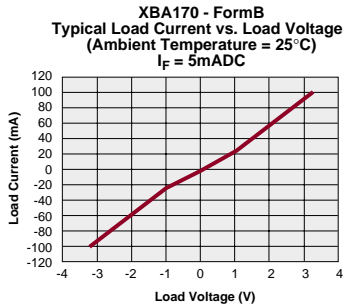
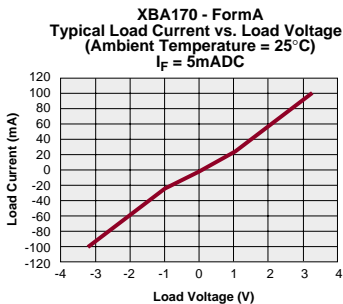
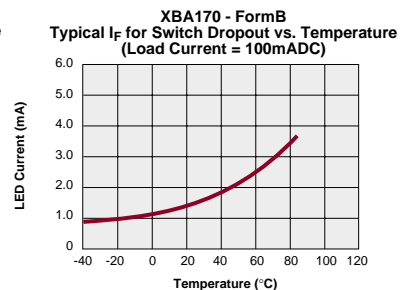
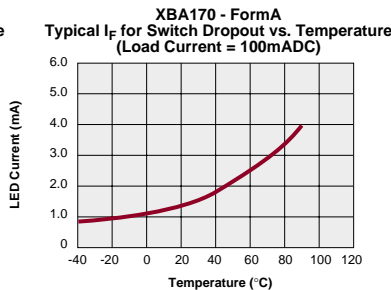
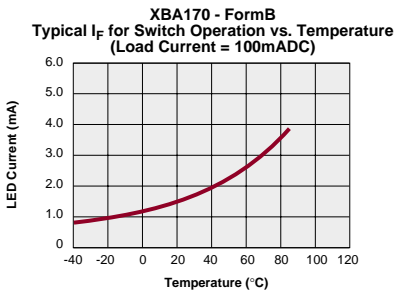
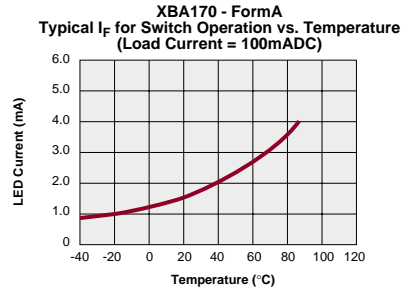
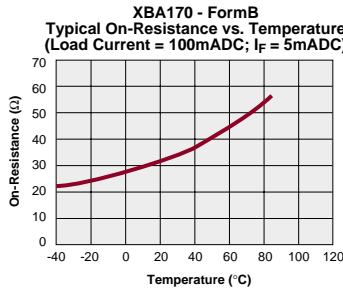
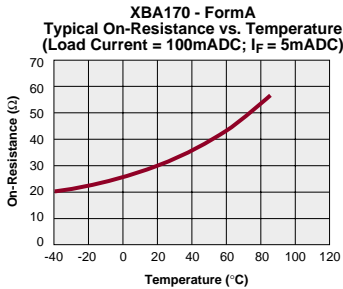
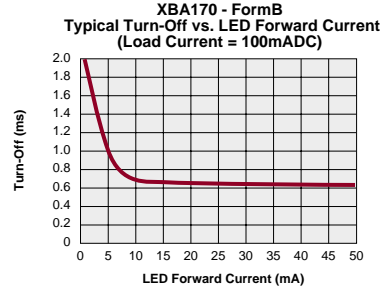
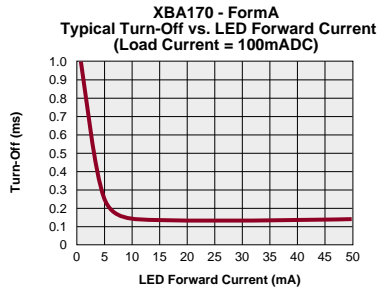
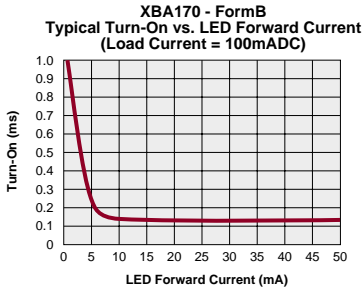



DESCRIPTION

The LBA120 is a 250V, 150mA, 20Ω independent 1-Form-A/1-Form-B solid state relay. Current limiting version available ("L" suffix).

FEATURES

- Small 8 Pin DIP Package
- Low Drive Power Requirements (TTL/CMOS Compatible)
- No Moving Parts
- High Reliability
- Arc-Free With No Snubbing Circuits
- 3750V_{RMS} Input/Output Isolation
- FCC Compatible
- VDE Compatible
- No EMI/RFI Generation
- Machine Insertable, Wave Solderable
- Current Limiting, Surface Mount and Tape & Reel Versions Available

APPROVALS

- UL Recognized: File Number E76270
- CSA Certified: File Number LR 43639-10
- BSI Certified to:
 - BS EN 60950:1992 (BS7002:1992)
Certificate #: 7344
 - BS EN 41003:1993
Certificate #: 7344

OPTIONS / SUFFIXES

- P: Flatpack Package
- L: Current Limiting
- TR: Tape & Reel
- S: Surface Mount Package

APPLICATIONS

- Telecommunications
 - Telecom Switching
 - Tip/Ring Circuits
 - Modem Switching (Laptop, Notebook, Pocket Size)
 - Hookswitch
 - Dial Pulsing
 - Ground Start
 - Ringer Injection
- Instrumentation
 - Multiplexers
 - Data Acquisition
 - Electronic Switching
 - I/O Subsystems
 - Meters (Watt-Hour, Water, Gas)
- Medical Equipment-Patient/Equipment Isolation
- Security
- Aerospace
- Industrial Controls

RATINGS (@ 25° C)

Parameter	Min	Typ	Max	Units
Input Power Dissipation	-	-	150 ¹	mW
Input Control Current	-	-	50	mA
Peak (10ms)	-	-	1	A
Reverse Input Voltage	-	-	5	V
Total Power Dissipation	-	-	800 ²	mW
Capacitance				
Input to Output	-	3	-	pF
Isolation Voltage				
Input to Output	3750	-	-	V _{RMS}
Operational Temperature	-40	-	+85	°C
Storage Temperature	-40	-	+125	°C
Soldering Temperature				
(10 Seconds Max.)				
DIP Package	-	-	+260	°C
Flatpack/Surface Mount Package	-	-	+220	°C

¹ Derate Linearly 1.33 mw/°C
² Derate Linearly 1.67 mw/°C

Switching Characteristics of Normally Open (Form A) Devices

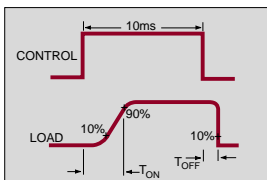

Switching Characteristics of Normally Closed (Form B) Devices

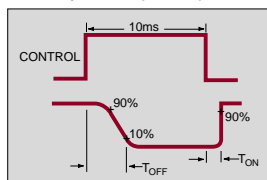

Note: For Mechanical Dimensions See Pages 396-401

LBA120/LBA120L

SPECIFICATIONS

PARAMETERS	CONDITIONS	SYMBOL	LBA120			LBA120L			UNITS
			MIN	TYP	MAX	MIN	TYP	MAX	
Output Characteristics @ 25°C									
Load Voltage (Peak)	-	V_L	-	-	250	-	-	250	V
Load Current* (Continuous) AC/DC Configuration	-	I_L	-	-	170	-	-	150	mA
Peak Load Current	10ms	I_{LPK}	-	-	400	-	-	-	mA
On-Resistance AC/DC Configuration	$I_L=170mA$	R_{ON}	-	16	20	-	21	25	Ω
Off-State Leakage Current	$V_L=250V$	I_{LEAK}	-	-	1	-	-	1	μA
Switching Speeds									
Turn-On	$I_F=5mA, V_L=10V$	T_{ON}	-	-	5	-	-	5	ms
Turn-Off	$I_F=5mA, V_L=10V$	T_{OFF}	-	-	5	-	-	5	ms
Output Capacitance	50V; f=1MHz	C_{OUT}	-	50	-	-	50	-	pF
Load Current Limiting	Form A only	I_{CL}	-	-	-	190	235	280	mA
Input Characteristics @ 25°C									
Input Control Current	$I_L=120mA$	I_F	5	-	50	5	-	50	mA
Input Dropout Current	-	-	0.4	0.7	-	0.4	0.7	-	mA
Input Voltage Drop	$I_F=5mA$	V_F	0.9	1.2	1.4	0.9	1.2	1.4	V
Reverse Input Voltage	-	V_R	-	-	5	-	-	5	V
Reverse Input Current	$V_R=5V$	I_R	-	-	10	-	-	10	μA
Input to Output Capacitance	-	$C_{I/O}$	-	3	-	-	3	-	pF
Input to Output Isolation	-	$V_{I/O}$	3750	-	-	3750	-	-	V_{RMS}

*NOTE: If both poles operate simultaneously load current must be derated so as not to exceed the package power dissipation value.

LBA120 Pinout

AC/DC Configuration

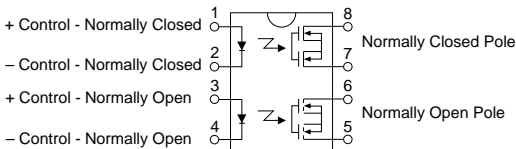

LBA120L Pinout

AC/DC Configuration

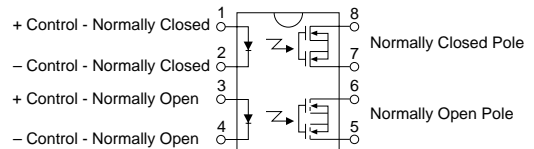

Note: For Mechanical Dimensions See Pages 396-401

PERFORMANCE DATA

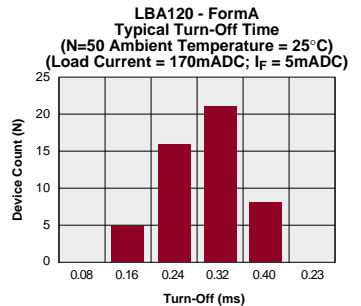
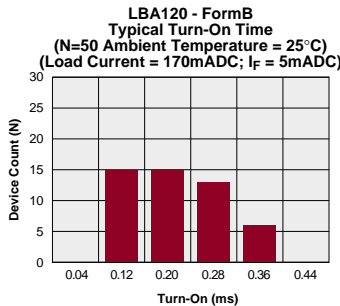
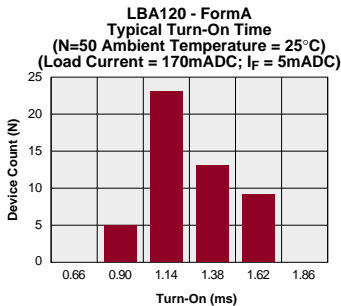
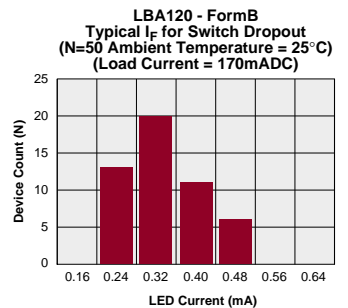
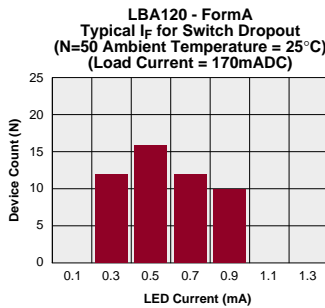
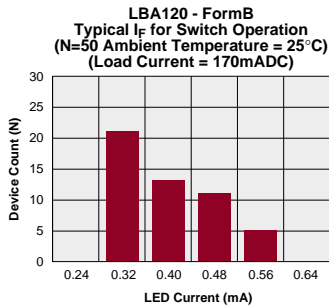
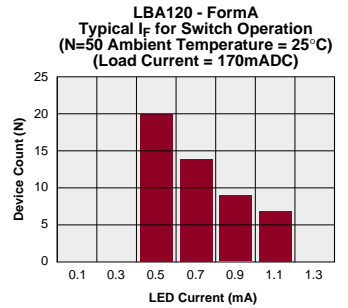
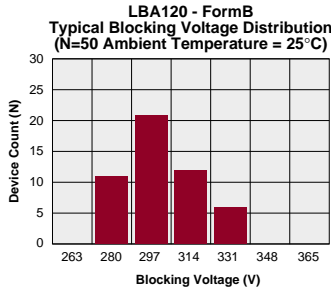
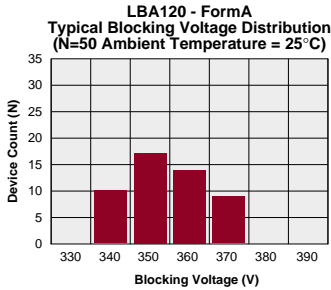
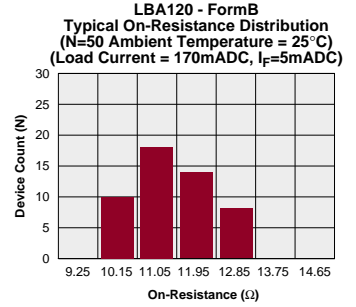
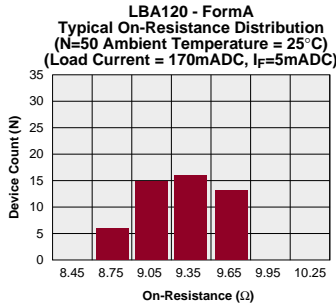
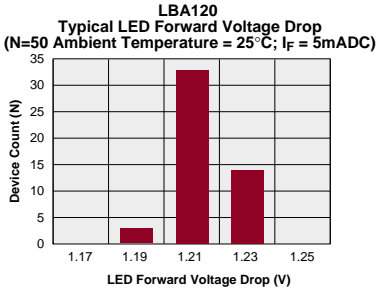

PERFORMANCE DATA

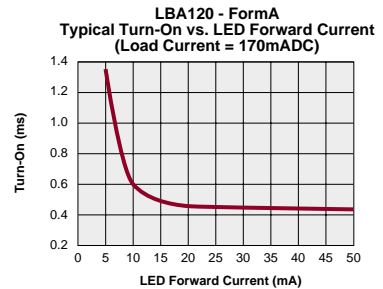
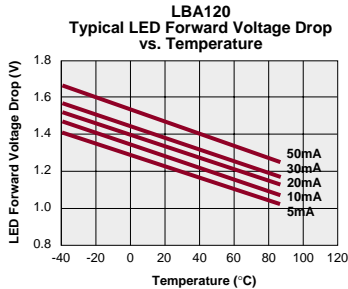
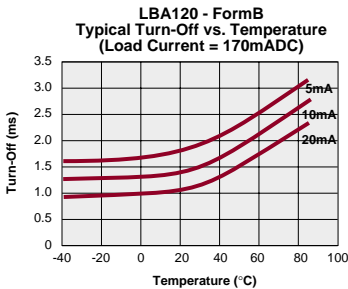
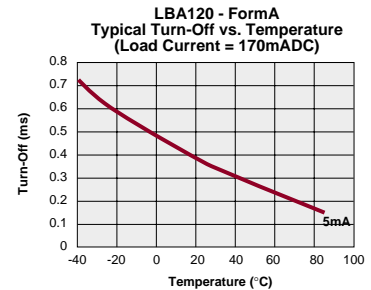
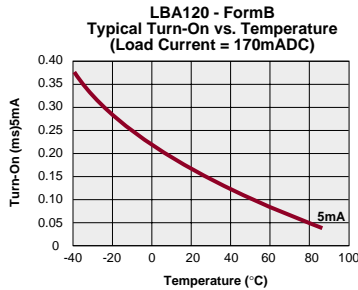
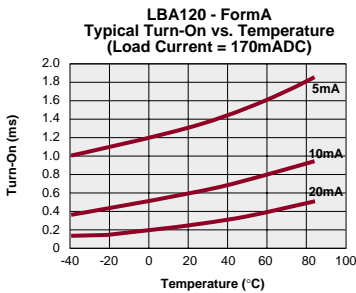
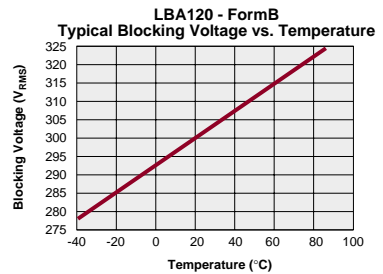
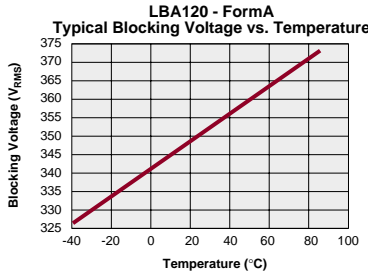
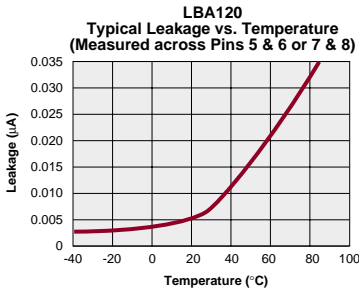
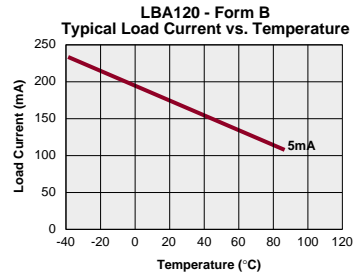
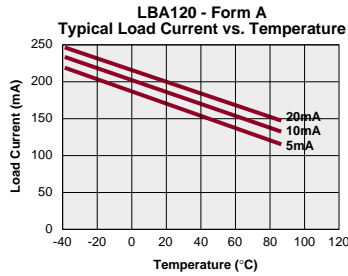
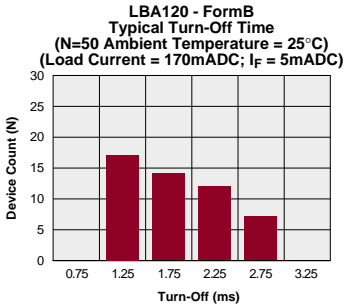

PERFORMANCE DATA

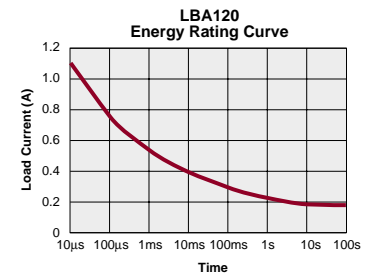
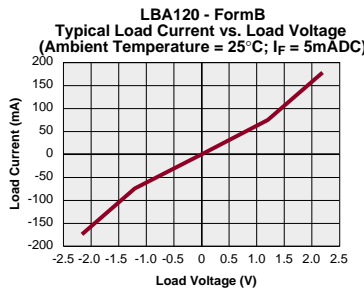
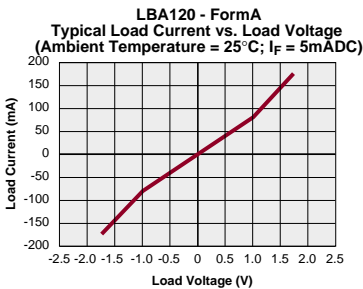
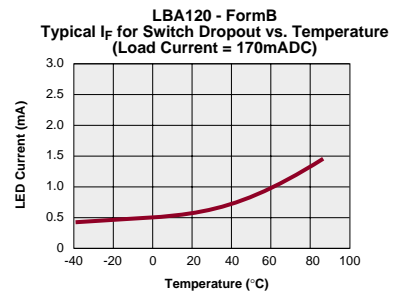
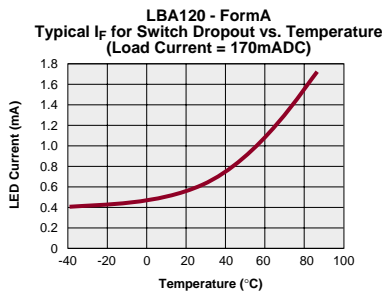
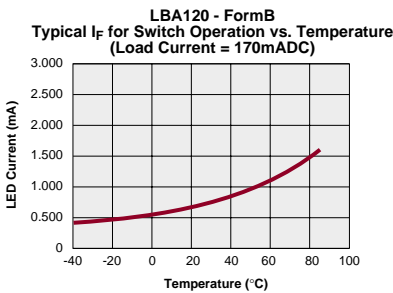
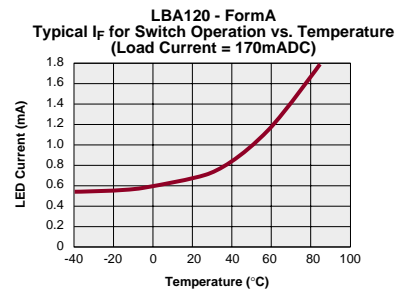
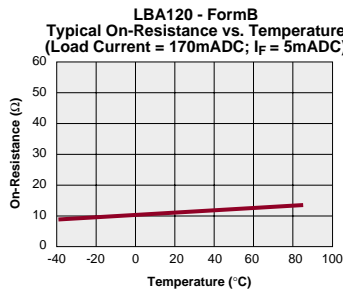
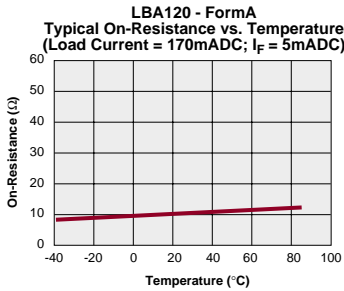
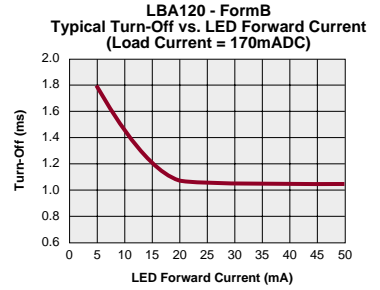
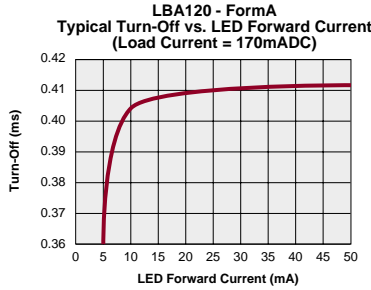
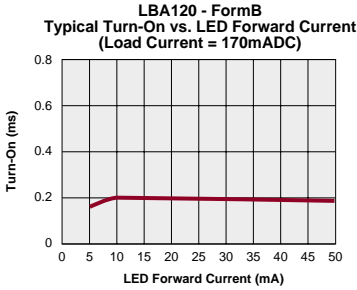

LBA120/LBA120L

PERFORMANCE DATA

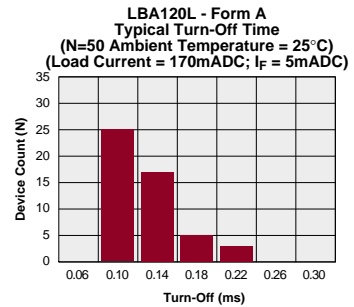
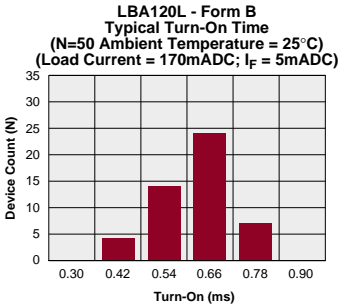
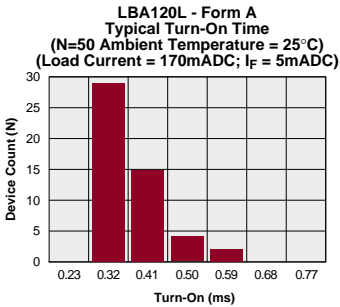
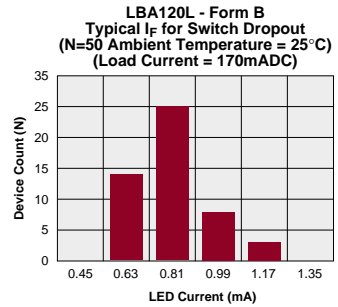
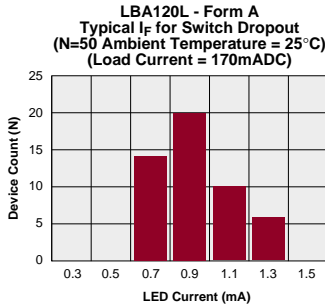
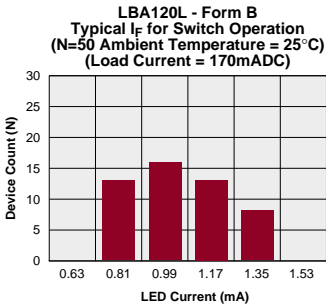
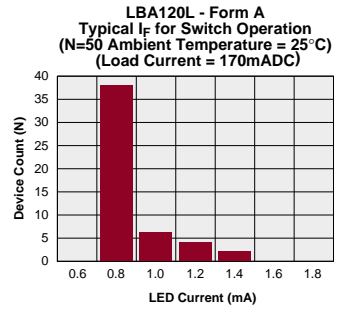
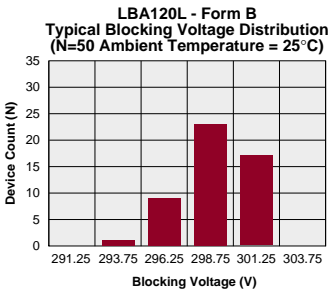
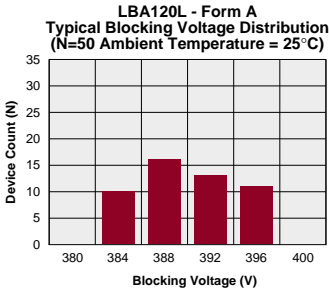
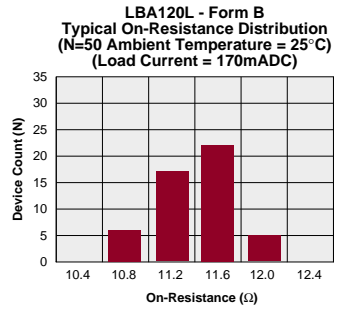
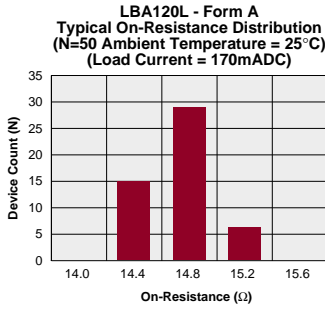
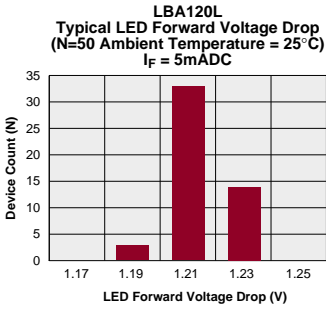

PERFORMANCE DATA

LBA120L - Form B
Typical Turn-Off Time
(N=50 Ambient Temperature = 25°C)
(Load Current = 170mADC; I_F = 5mADC)

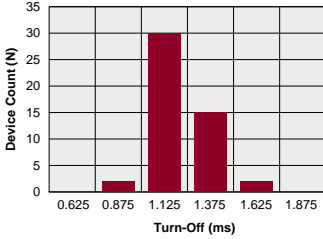

LBA120L - Form A
Typical Load Current vs. Temperature

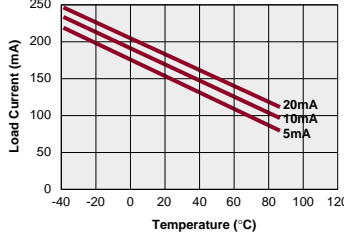

LBA120L - Form B
Typical Load Current vs. Temperature

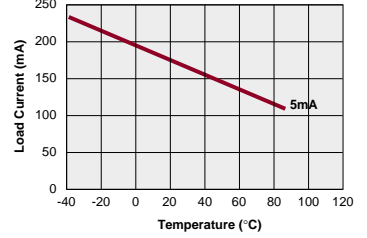

LBA120L - Form A
Typical Leakage vs. Temperature
(Measured across Pins 4 & 6)

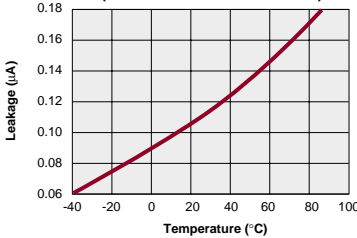

LBA120L - Form B
Typical Leakage vs. Temperature
(Measured across Pins 4 & 6)

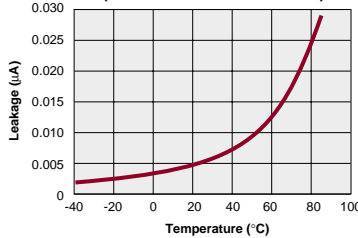

LBA120L - Form A
Typical Blocking Voltage vs. Temperature

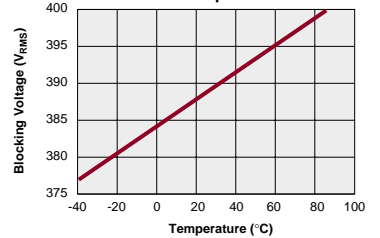

LBA120L - Form B
Typical Blocking Voltage vs. Temperature

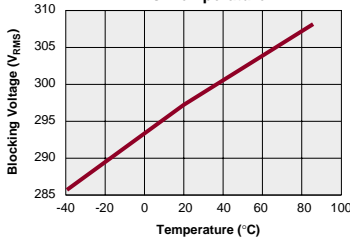

LBA120L - Form A
Typical Turn-On vs. Temperature
(Load Current = 170mADC)

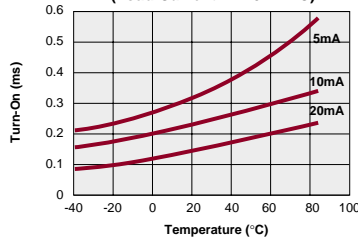

LBA120L - Form B
Typical Turn-On vs. Temperature
(Load Current = 170mADC)

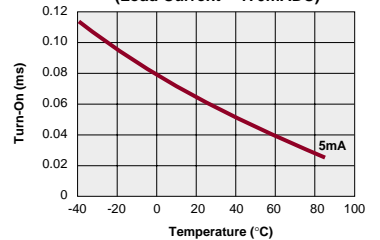

LBA120L - Form A
Typical Turn-Off vs. Temperature
(Load Current = 170mADC)

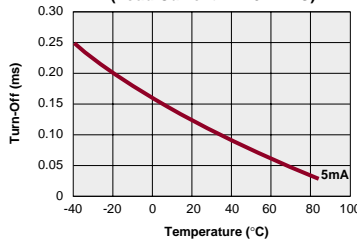

LBA120L - Form B
Typical Turn-Off vs. Temperature
(Load Current = 170mADC)

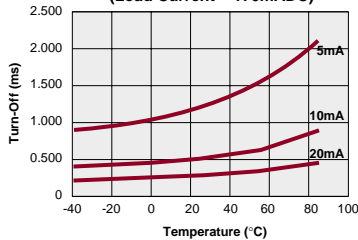

LBA120L
Typical LED Forward Voltage Drop vs. Temperature

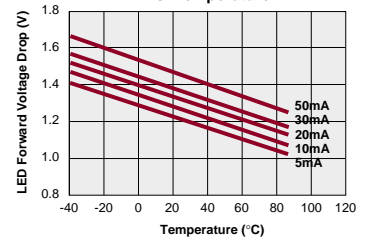

LBA120/LBA120L

PERFORMANCE DATA

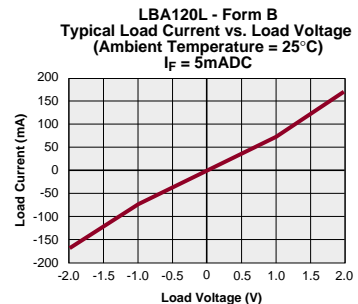
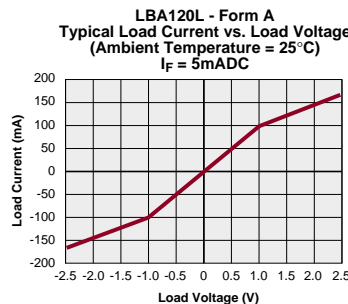
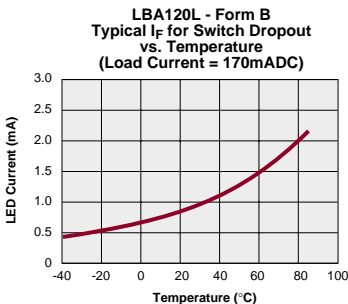
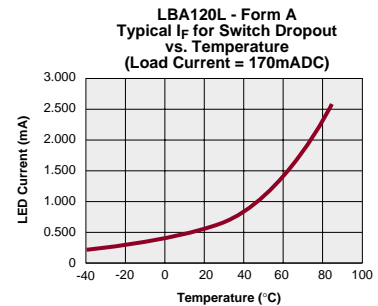
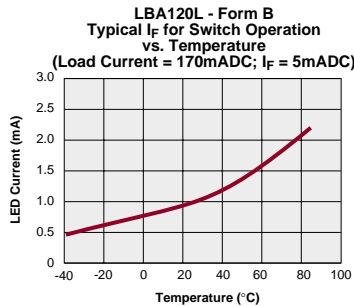
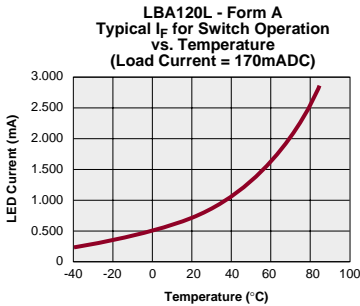
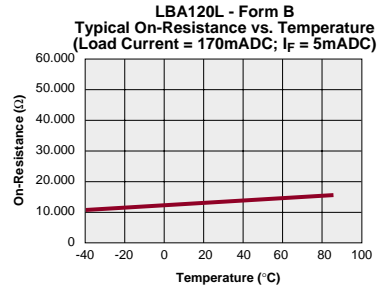
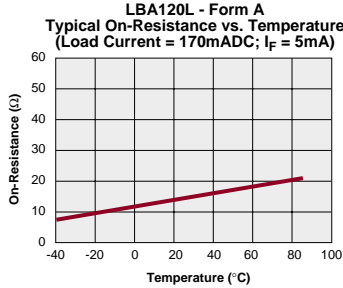
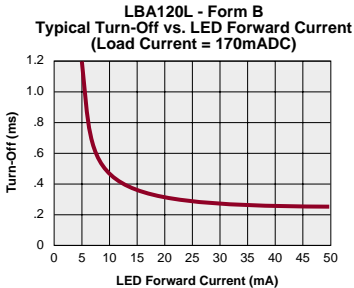
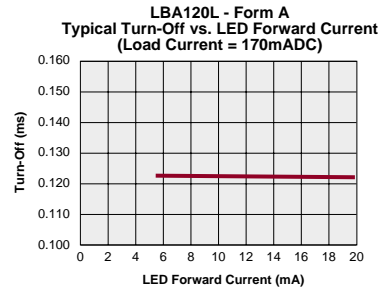
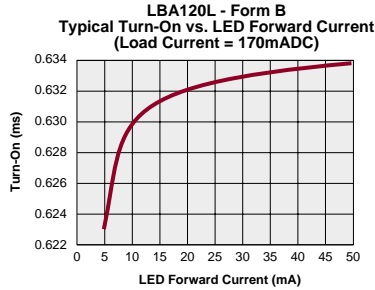
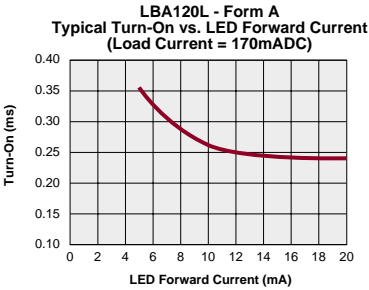

PERFORMANCE DATA

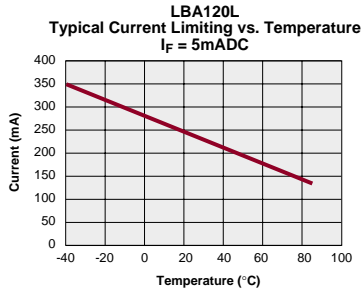
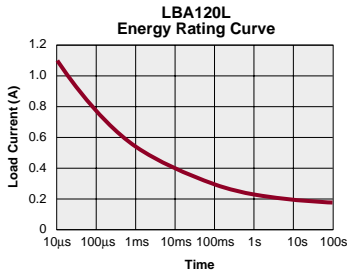

LBA126



DESCRIPTION

The LBA126 is a 250V, 170mA, 15Ω independent 1-Form-A/1-Form-B solid state relay.

FEATURES

- Small 8 Pin DIP Package
- Low Drive Power Requirements (TTL/CMOS Compatible)
- No Moving Parts
- High Reliability
- Arc-Free With No Snubbing Circuits
- 3750V_{RMS} Input/Output Isolation
- FCC Compatible
- VDE Compatible
- No EMI/RFI Generation
- Machine Insertable, Wave Solderable
- Current Limiting, Surface Mount and Tape & Reel Versions Available

APPROVALS

- UL Recognized: File Number E76270
- CSA Certified: File Number LR 43639-10
- BSI Certified to:
 - BS EN 60950:1992 (BS7002:1992) Certificate #: 7344
 - BS EN 41003:1993 Certificate #: 7344

OPTIONS / SUFFIXES

- P: Flatpack Package
- S: Surface Mount Package
- TR: Tape & Reel

Switching Characteristics of Normally Open (Form A) Devices

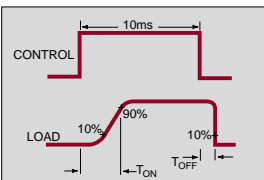

Switching Characteristics of Normally Closed (Form B) Devices

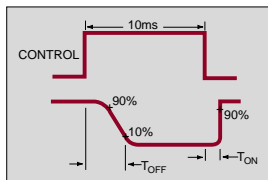

APPLICATIONS

- Telecommunications
 - Telecom Switching
 - Tip/Ring Circuits
 - Modem Switching (Laptop, Notebook, Pocket Size)
 - Hookswitch
 - Dial Pulsing
 - Ground Start
 - Ringer Injection
- Instrumentation
 - Multiplexers
 - Data Acquisition
 - Electronic Switching
 - I/O Subsystems
 - Meters (Watt-Hour, Water, Gas)
- Medical Equipment-Patient/Equipment Isolation
- Security
- Aerospace
- Industrial Controls

RATINGS (@ 25° C)

Parameter	Min	Typ	Max	Units
Input Power Dissipation	-	-	150 ¹	mW
Input Control Current	-	-	50	mA
Peak (10ms)	-	-	1	A
Reverse Input Voltage	-	-	5	V
Total Power Dissipation	-	-	800 ²	mW
Capacitance				
Input to Output	-	3	-	pF
Isolation Voltage				
Input to Output	3750	-	-	V _{RMS}
Operational Temperature	-40	-	+85	°C
Storage Temperature	-40	-	+125	°C
Soldering Temperature (10 Seconds Max.)				
DIP Package	-	-	+260	°C
Flatpack/Surface Mount Package	-	-	+220	°C

¹ Derate Linearly 1.33 mw/°C

² Derate Linearly 1.67 mw/°C

Note: For Mechanical Dimensions See Pages 396-401

SPECIFICATIONS

PARAMETERS	CONDITIONS	SYMBOL	MIN	TYP	MAX	UNITS
Output Characteristics @ 25°C						
Load Voltage (Peak)	-	V_L	-	-	250	V
Load Current *(Continuous) AC/DC Configuration	-	I_L	-	-	170	mA
Peak Load Current	10ms	I_{LPK}	-	-	-	mA
On-Resistance AC/DC Configuration	$I_L=170mA$	R_{ON}	-	10	15	Ω
Off-State Leakage Current	$V_L=250V$	I_{LEAK}	-	-	1	μA
Switching Speeds						
Turn-On	$I_F=5mA, V_L=10V$	T_{ON}	-	-	5	ms
Turn-Off	$I_F=5mA, V_L=10V$	T_{OFF}	-	-	5	ms
Output Capacitance	50V; f=1MHz	C_{OUT}	-	50	-	pF
Load Current Limiting		I_{CL}	-	-	-	mA
Input Characteristics @ 25°C						
Input Control Current	$I_L=170mA$	I_F	5	-	50	mA
Input Dropout Current	-	-	0.4	0.7	-	mA
Input Voltage Drop	$I_F=5mA$	V_F	0.9	1.2	1.4	V
Reverse Input Voltage	-	V_R	-	-	5	V
Reverse Input Current	$V_R=5V$	I_R	-	-	10	μA
Input to Output Capacitance	-	$C_{I/O}$	-	3	-	pF
Input to Output Isolation	-	$V_{I/O}$	3750	-	-	V_{RMS}

*NOTE: If both poles operate simultaneously load current must be derated so as not to exceed the package power dissipation value.

LBA126 Pinout

AC/DC Configuration

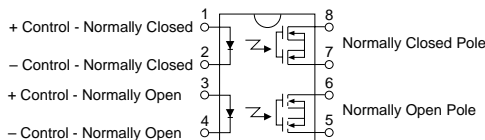

Note: For Mechanical Dimensions See Pages 396-401

www.cpclare.com

LBA126

PERFORMANCE DATA

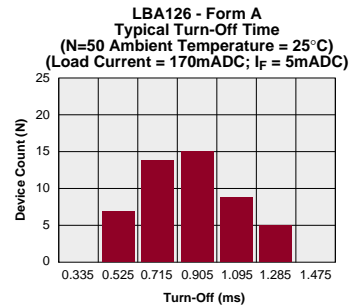
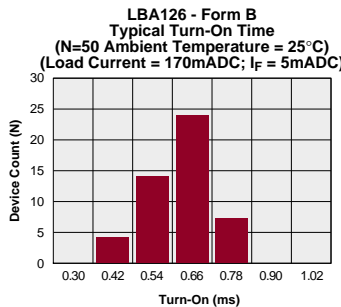
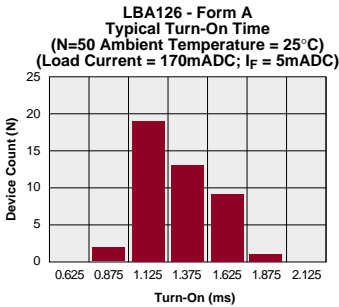
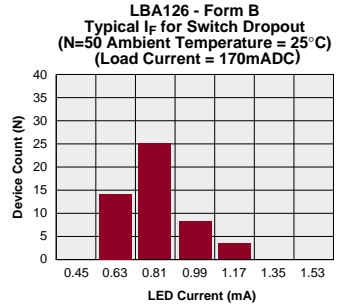
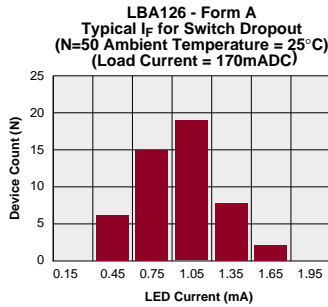
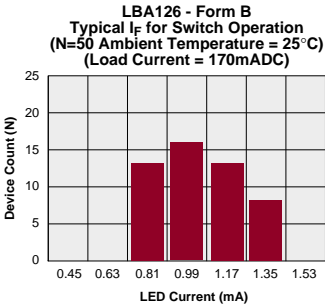
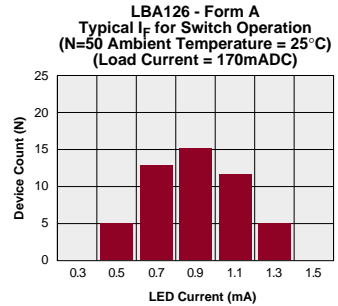
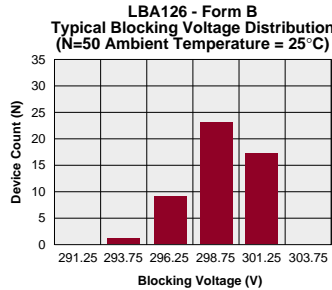
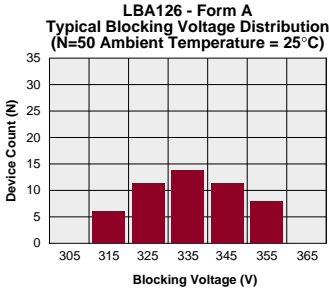
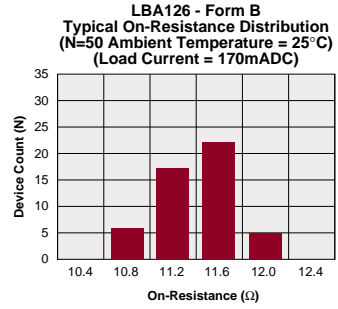
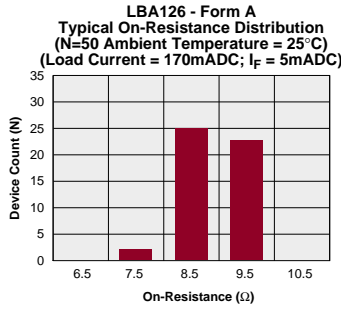
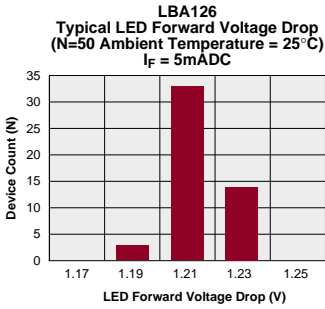

PERFORMANCE DATA

LBA126 - Form B
Typical Turn-Off Time
(N=50 Ambient Temperature = 25°C)
(Load Current = 170mADC; I_F = 5mADC)

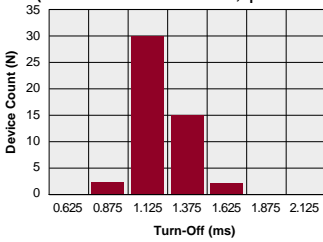

LBA126 - Form A
Typical Load Current vs. Temperature

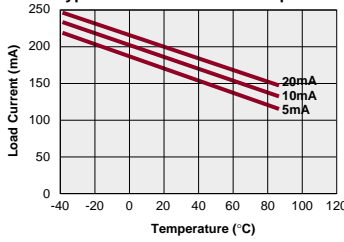

LBA126 - Form B
Typical Load Current vs. Temperature

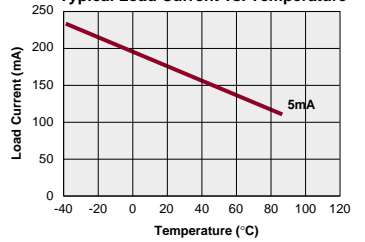

LBA126 - Form A
Typical Leakage vs. Temperature
(Measured across Pins 4 & 6)

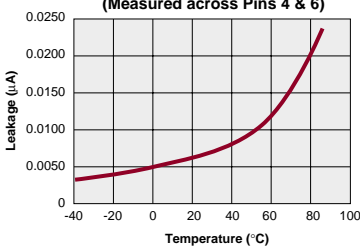

LBA126 - Form B
Typical Leakage vs. Temperature
(Measured across Pins 4 & 6)

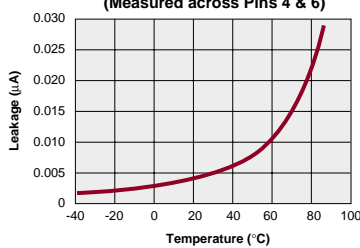

LBA126 - Form A
Typical Blocking Voltage vs. Temperature

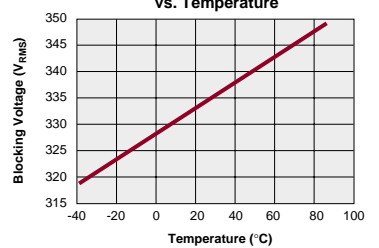

LBA126 - Form B
Typical Blocking Voltage vs. Temperature

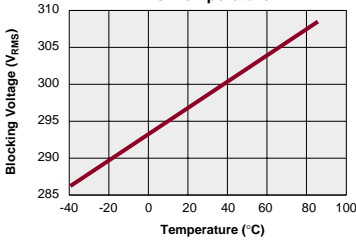

LBA126 - Form A
Typical Turn-On vs. Temperature
(Load Current = 170mADC)

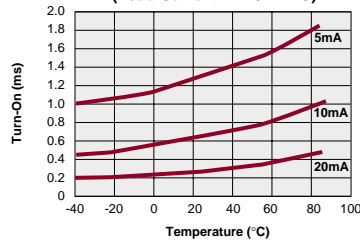

LBA126 - Form B
Typical Turn-On vs. Temperature
(Load Current = 170mADC)

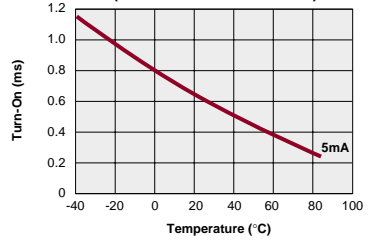

LBA126 - Form A
Typical Turn-Off vs. Temperature
(Load Current = 170mADC)

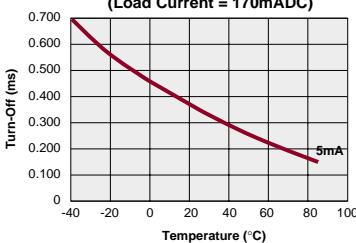

LBA126 - Form B
Typical Turn-Off vs. Temperature
(Load Current = 170mADC)

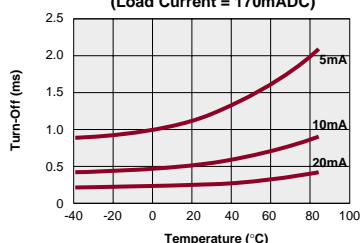

LBA126 - Form A
Typical LED Forward Voltage Drop vs. Temperature

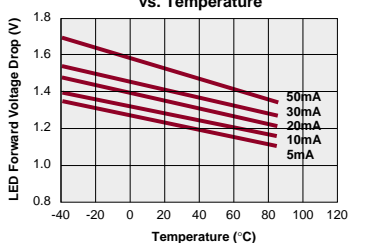

LBA126

PERFORMANCE DATA

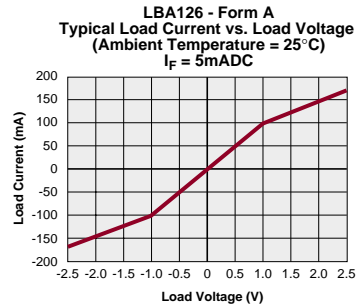
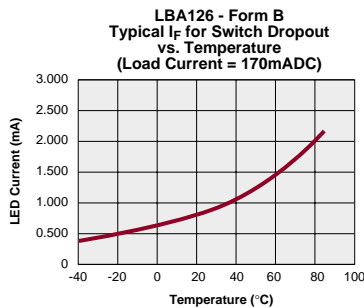
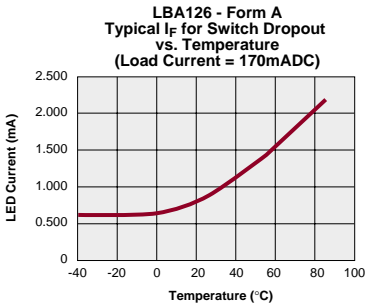
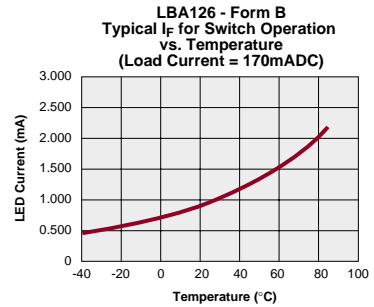
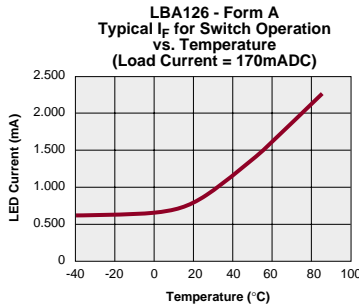
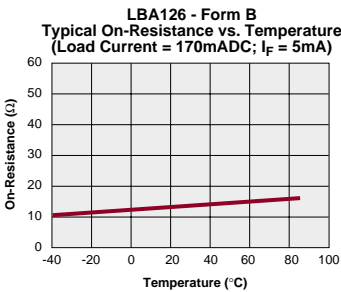
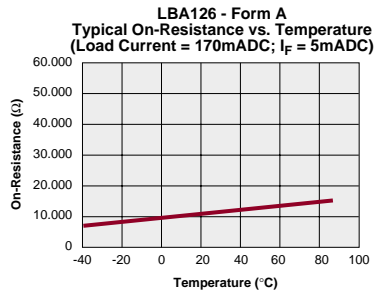
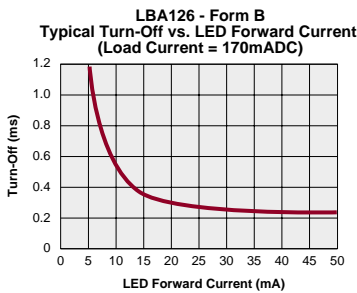
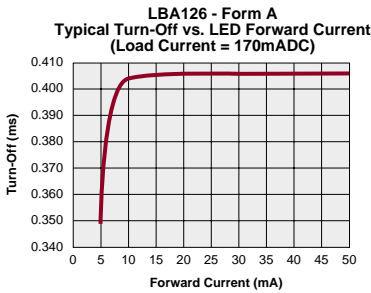
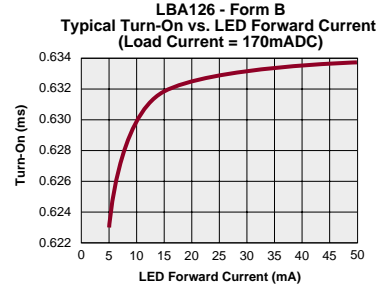
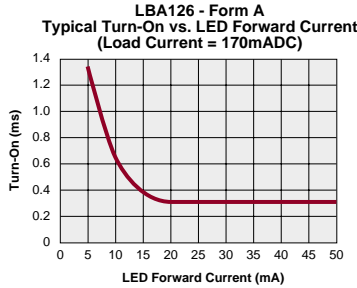
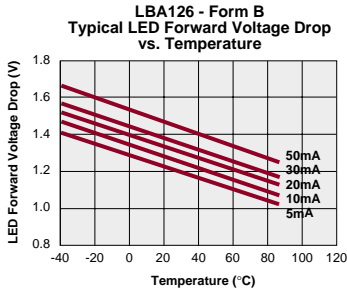

PERFORMANCE DATA

LBA126 - Form B
Typical Load Voltage vs. Load Current
(Ambient Temperature = 25°C)
I_F = 5mADC

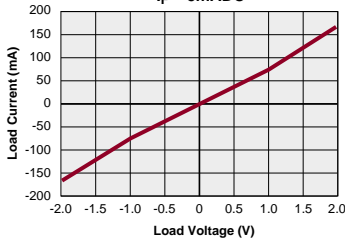

LBA126
Energy Rating Curve

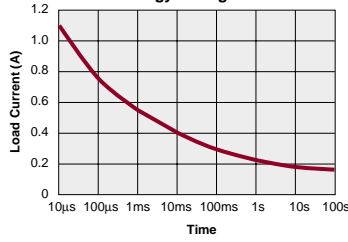

LBA127/LBA127L



DESCRIPTION

The LBA127 is a 250V, 200mA, 10Ω independent 1-Form-A/1-Form-B solid state relay. Current limiting version available ("L" suffix).

FEATURES

- Small 8 Pin DIP Package
- Low Drive Power Requirements (TTL/CMOS Compatible)
- No Moving Parts
- High Reliability
- Arc-Free With No Snubbing Circuits
- 3750V_{RMS} Input/Output Isolation
- FCC Compatible
- VDE Compatible
- No EMI/RFI Generation
- Machine Insertable, Wave Solderable
- Current Limiting, Surface Mount and Tape & Reel Version Available

APPROVALS

- UL Recognized: File Number E76270
- CSA Certified: File Number LR 43639-10
- BSI Certified to:
 - BS EN 60950:1992 (BS7002:1992)
Certificate #: 7344
 - BS EN 41003:1993
Certificate #: 7344

OPTIONS / SUFFIXES

- P: Flatpack Package
- L: Current Limiting
- S: Surface Mount Package
- TR: Tape & Reel

Switching Characteristics of Normally Open (Form A) Devices

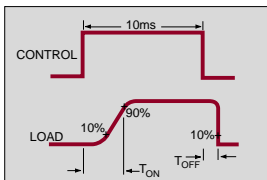

Switching Characteristics of Normally Closed (Form B) Devices

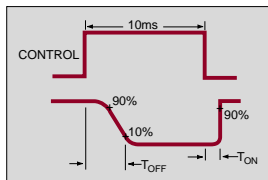

APPLICATIONS

- Telecommunications
 - Telecom Switching
 - Tip/Ring Circuits
 - Modem Switching (Laptop, Notebook, Pocket Size)
 - Hookswitch
 - Dial Pulsing
 - Ground Start
 - Ringer Injection
- Instrumentation
 - Multiplexers
 - Data Acquisition
 - Electronic Switching
 - I/O Subsystems
 - Meters (Watt-Hour, Water, Gas)
- Medical Equipment-Patient/Equipment Isolation
- Security
- Aerospace
- Industrial Controls

RATINGS (@ 25° C)

Parameter	Min	Typ	Max	Units
Input Power Dissipation	-	-	150 ¹	mW
Input Control Current	-	-	50	mA
Peak (10ms)	-	-	1	A
Reverse Input Voltage	-	-	5	V
Total Power Dissipation	-	-	800 ²	mW
Capacitance				
Input to Output	-	3	-	pF
Isolation Voltage				
Input to Output	3750	-	-	V _{RMS}
Operational Temperature	-40	-	+85	°C
Storage Temperature	-40	-	+125	°C
Soldering Temperature (10 Seconds Max.)				
DIP Package	-	-	+260	°C
Flatpack/Surface Mount Package	-	-	+220	°C

¹ Derate Linearly 1.33 mw/°C

² Derate Linearly 1.67 mw/°C

Note: For Mechanical Dimensions See Pages 396-401

SPECIFICATIONS

PARAMETERS	CONDITIONS	SYMBOL	LBA127			LBA127L			UNITS
			MIN	TYP	MAX	MIN	TYP	MAX	
Output Characteristics @ 25°C									
Load Voltage (Peak)	-	V_L	-	-	250	-	-	250	V
Load Current (Continuous) AC/DC Configuration	-	I_L	-	-	200	-	-	150	mA
Peak Load Current	10ms	I_{LPK}	-	-	400	-	-	-	mA
On-Resistance AC/DC Configuration	I_L =Load Current	R_{ON}	-	8	10	-	8	15	Ω
Off-State Leakage Current	V_L =250V	I_{LEAK}	-	-	1	-	-	1	μ A
Switching Speeds									
Turn-On	I_F =5mA, V_L =10V	T_{ON}	-	-	5	-	-	5	ms
Turn-Off	I_F =5mA, V_L =10V	T_{OFF}	-	-	5	-	-	5	ms
Output Capacitance	50V; f=1MHz	C_{OUT}	-	110	-	-	110	-	pF
Load Current Limiting	Form A only	I_{CL}	-	-	-	190	235	280	mA
Input Characteristics @ 25°C									
Input Control Current	I_L =Load Current	I_F	5	-	50	5	-	50	mA
Input Dropout Current	-	I_F	0.4	0.7	-	0.4	0.7	-	mA
Input Voltage Drop	I_F =5mA	V_F	0.9	1.2	1.4	0.9	1.2	1.4	V
Reverse Input Voltage	-	V_R	-	-	5	-	-	5	V
Reverse Input Current	V_R =5V	I_R	-	-	10	-	-	10	μ A
Input to Output Capacitance	-	$C_{I/O}$	-	3	-	-	3	-	pF
Input to Output Isolation	-	$V_{I/O}$	3750	-	-	3750	-	-	V_{RMS}

*NOTE: If both poles operate simultaneously load current must be derated so as not to exceed the package power dissipation value.

LBA127 Pinout

AC/DC Configuration

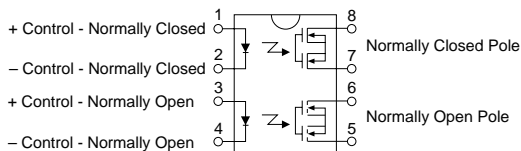

LBA127L Pinout

AC/DC Configuration

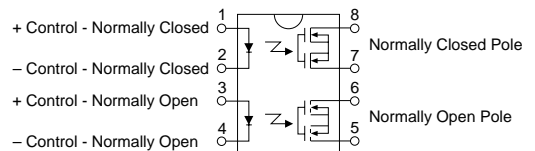

Note: For Mechanical Dimensions See Pages 396-401

PERFORMANCE DATA

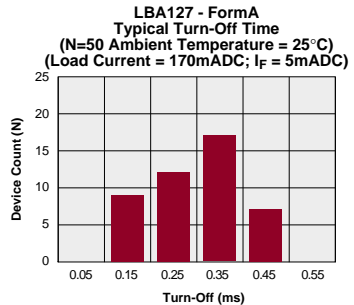
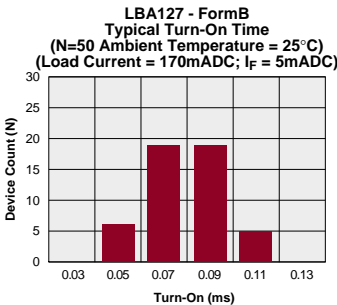
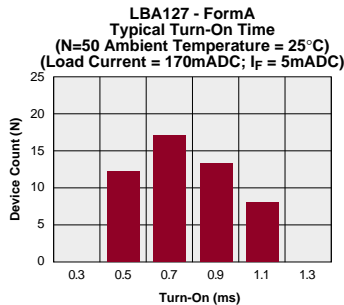
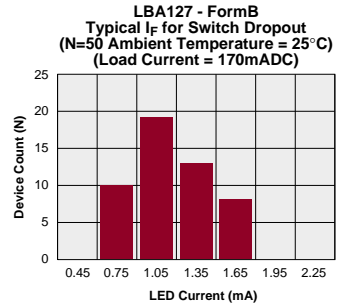
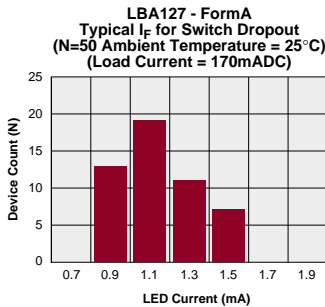
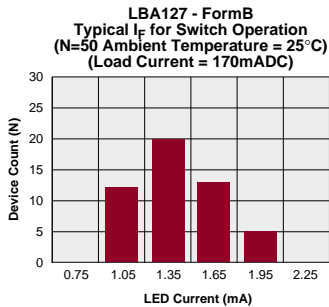
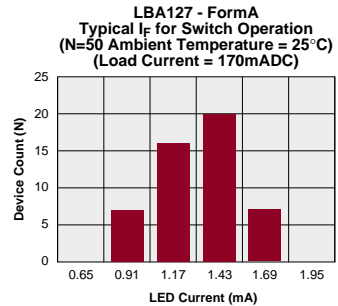
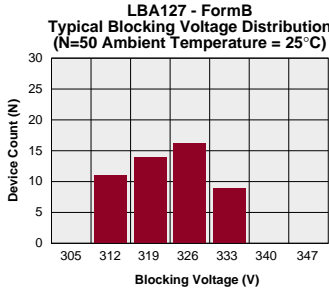
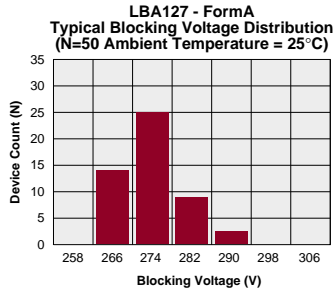
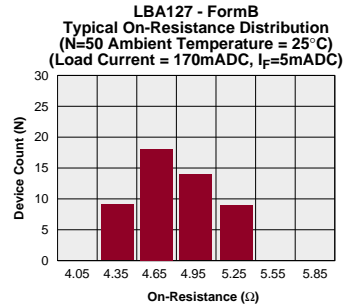
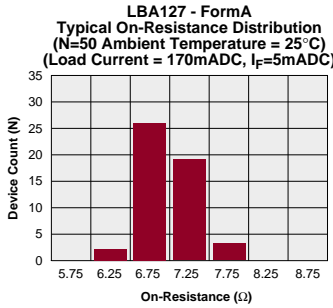
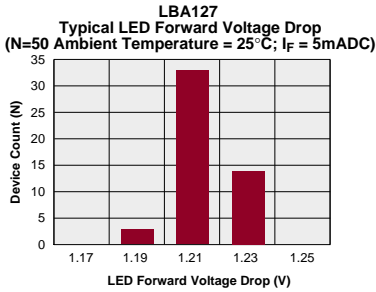

PERFORMANCE DATA

LBA127 - FormB
Typical Turn-Off Time
(N=50 Ambient Temperature = 25°C)
(Load Current = 170mADC; I_F = 5mADC)

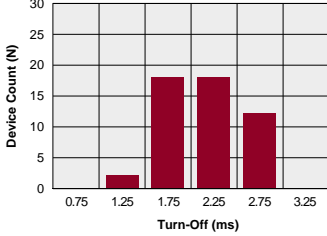

LBA127 - Form A
Typical Load Current vs. Temperature

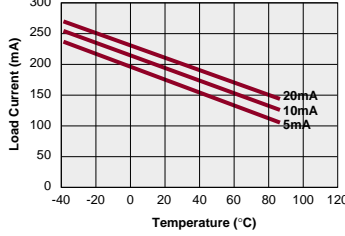

LBA127 - Form B
Typical Load Current vs. Temperature

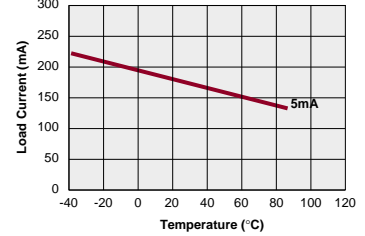

LBA127
Typical Leakage vs. Temperature
(Measured across Pins 5 & 6 or 7 & 8)

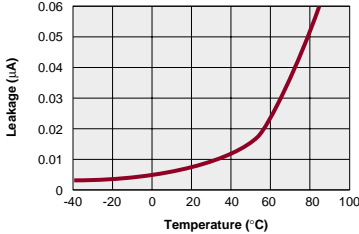

LBA127 - FormA
Typical Blocking Voltage vs. Temperature

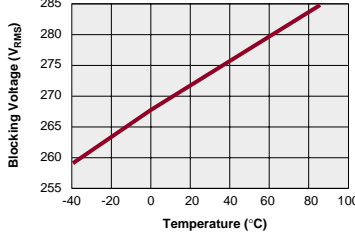

LBA127 - FormB
Typical Blocking Voltage vs. Temperature

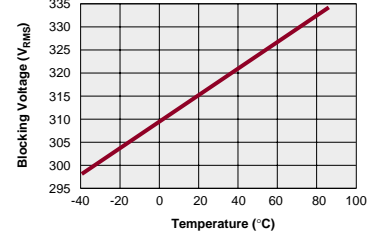

LBA127 - FormA
Typical Turn-On vs. Temperature
(Load Current = 170mADC)

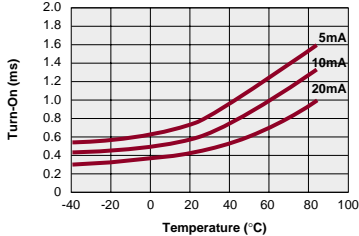

LBA127 - FormB
Typical Turn-On vs. Temperature
(Load Current = 170mADC)

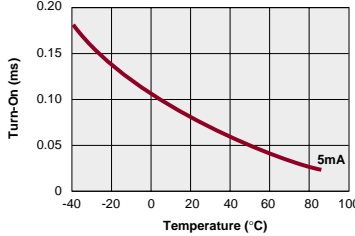

LBA127 - FormA
Typical Turn-Off vs. Temperature
(Load Current = 170mADC)

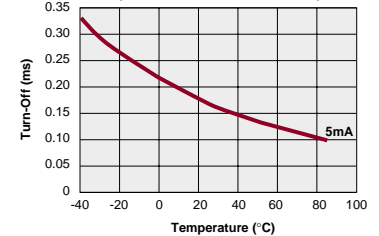

LBA127 - FormB
Typical Turn-Off vs. Temperature
(Load Current = 170mADC)

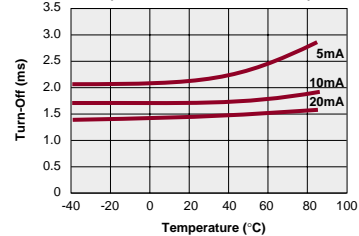

LBA127
Typical LED Forward Voltage Drop vs. Temperature

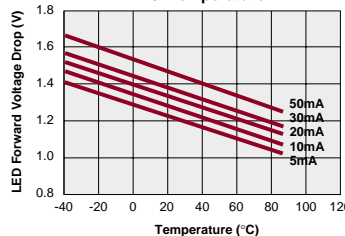

LBA127 - FormA
Typical Turn-On vs. LED Forward Current
(Load Current = 170mADC)

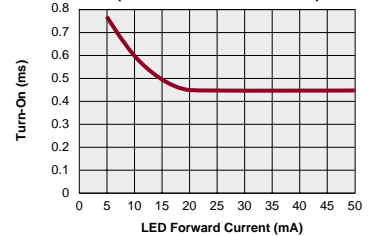

PERFORMANCE DATA

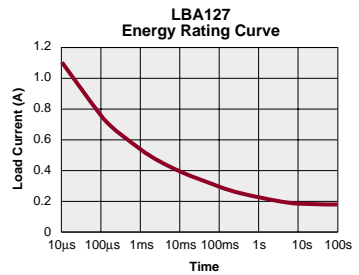
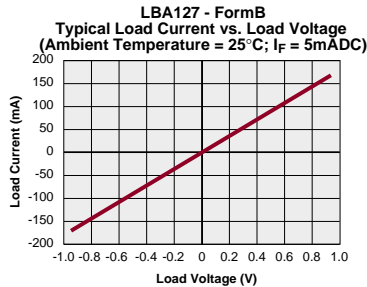
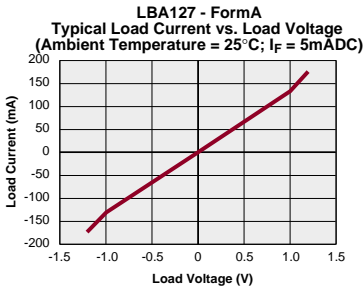
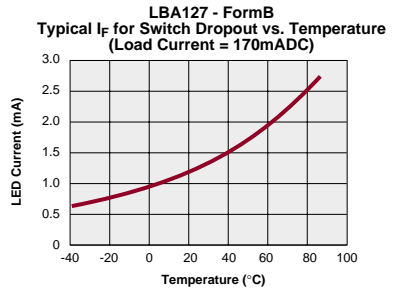
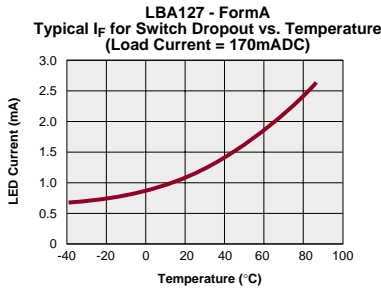
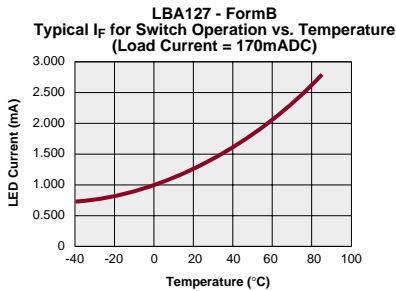
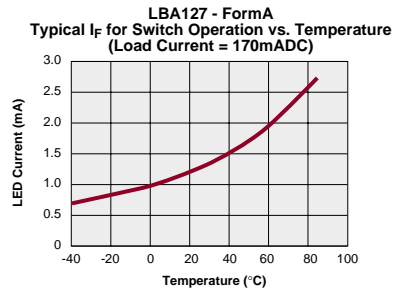
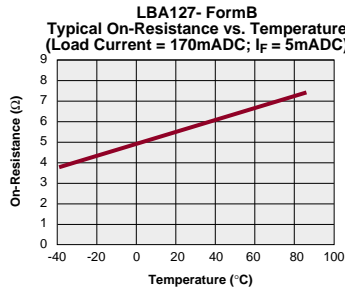
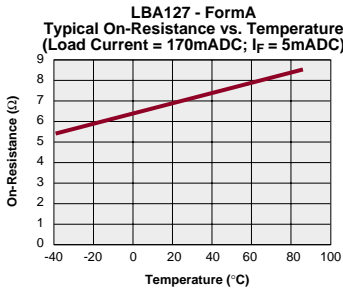
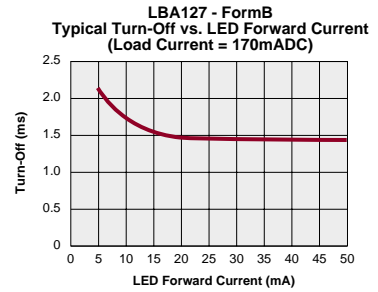
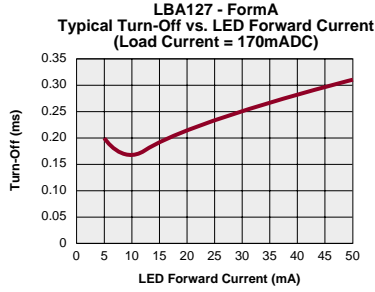
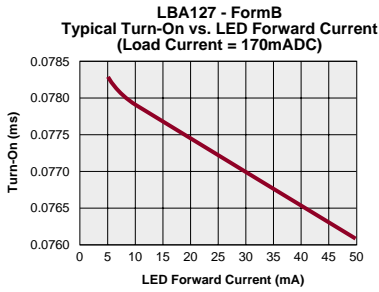

PERFORMANCE DATA

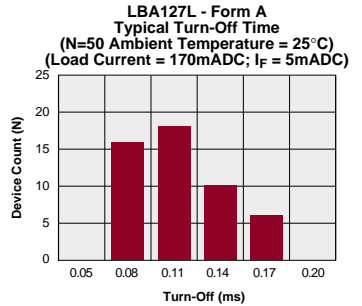
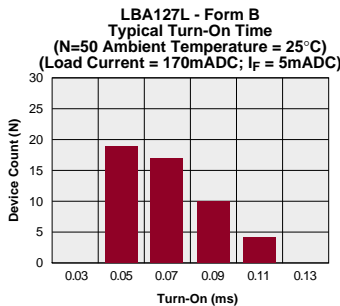
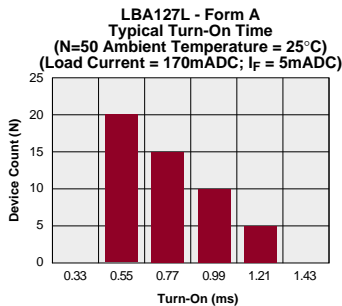
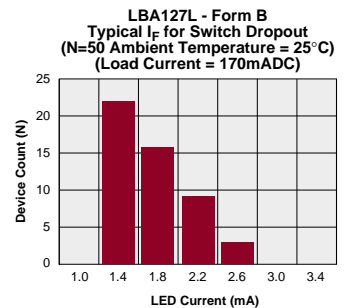
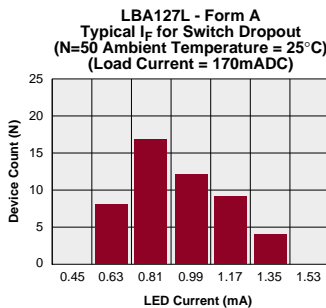
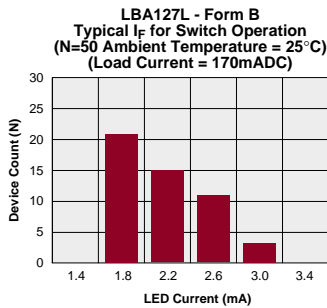
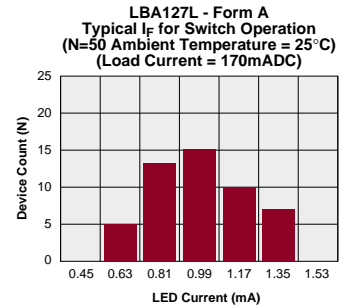
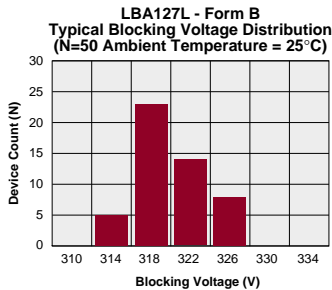
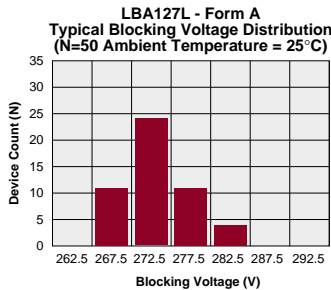
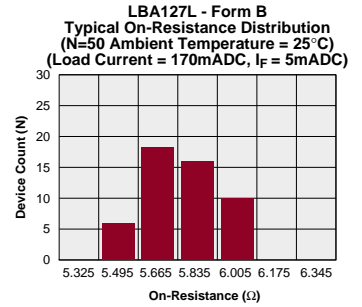
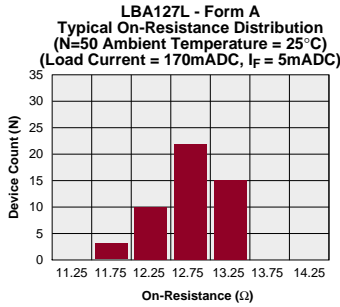
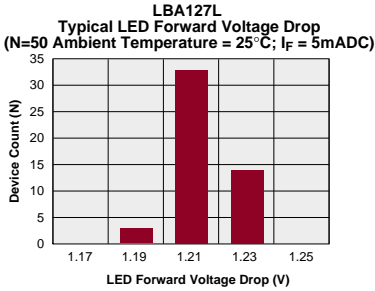

LBA127/LBA127L

PERFORMANCE DATA

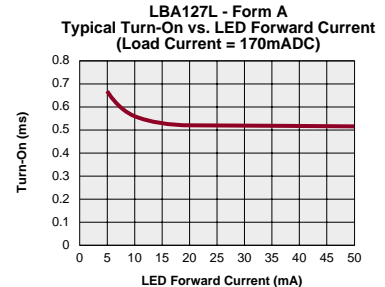
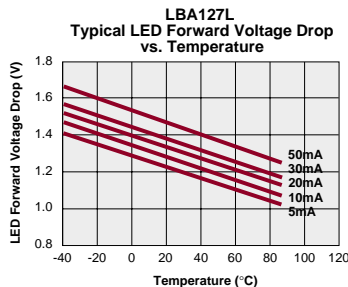
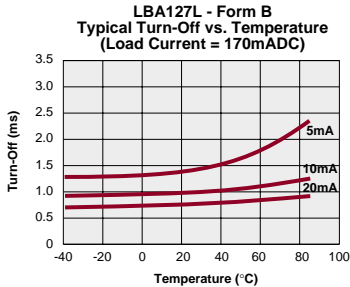
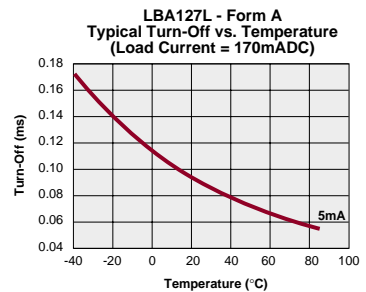
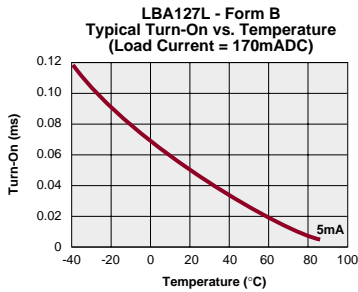
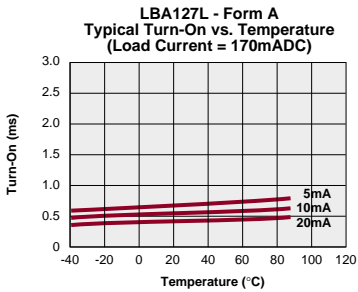
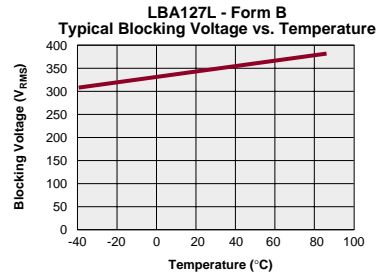
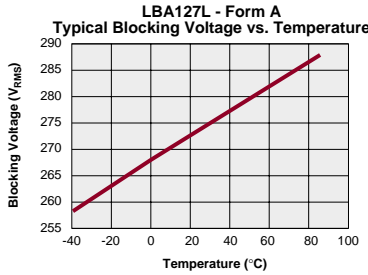
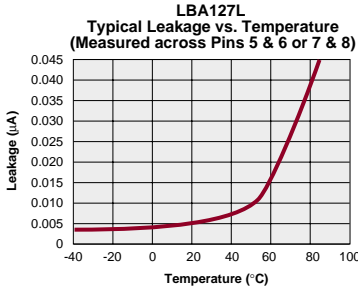
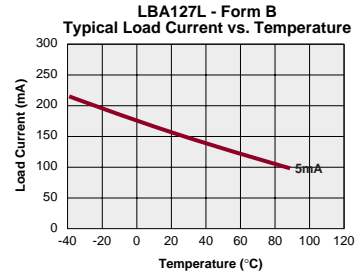
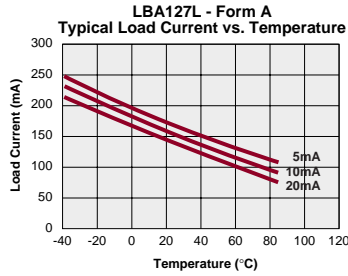
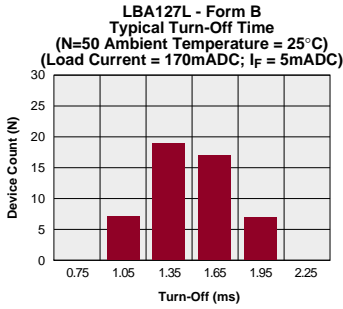

PERFORMANCE DATA

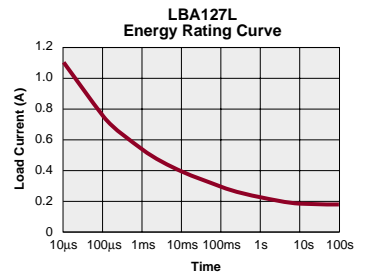
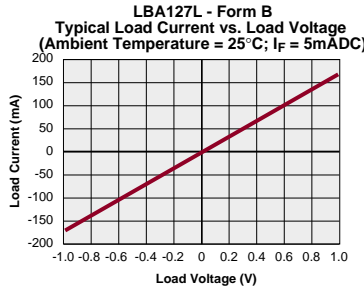
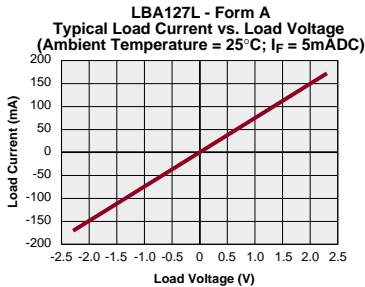
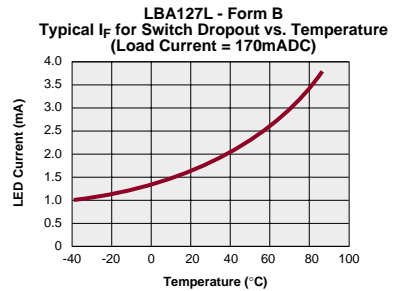
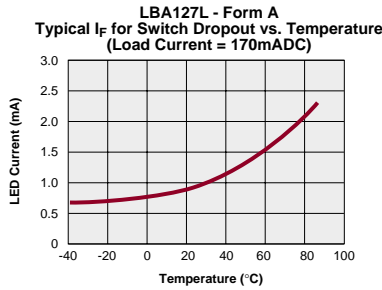
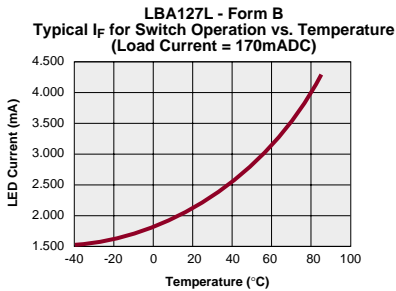
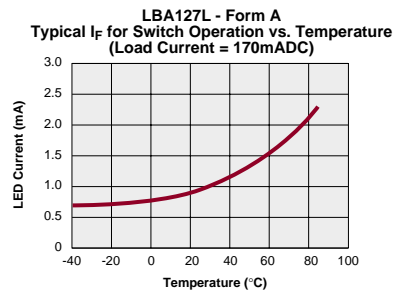
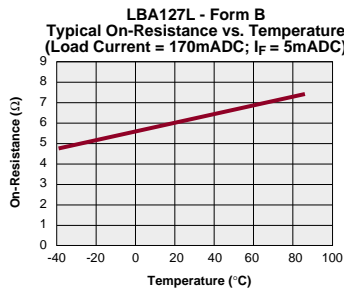
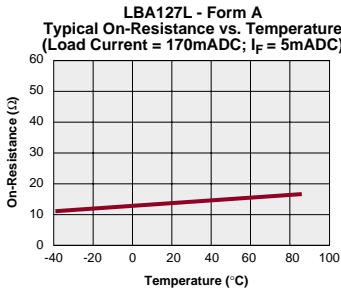
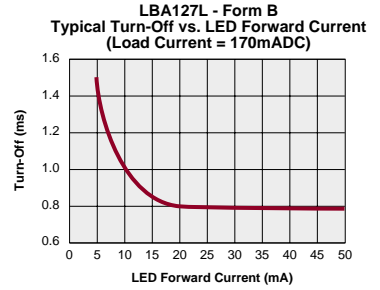
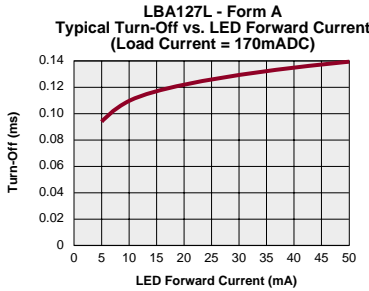
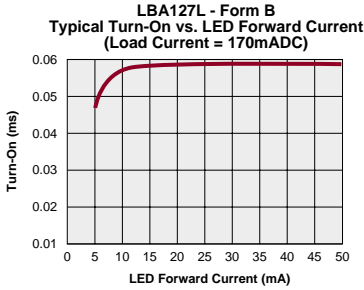

PERFORMANCE DATA

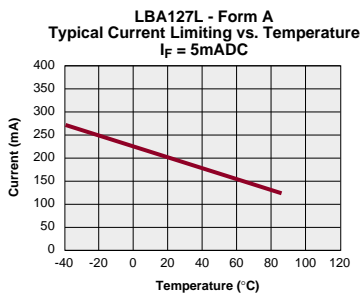



DESCRIPTION

The LBB110 is a 350V, 120mA, 35Ω type 2-Form-B solid state relay.

FEATURES

- Small 8 Pin DIP Package
- Low Drive Power Requirements (TTL/CMOS Compatible)
- No Moving Parts
- High Reliability
- Arc-Free With No Snubbing Circuits
- 3750V_{RMS} Input/Output Isolation
- FCC Compatible
- VDE Compatible
- No EMI/RFI Generation
- Machine Insertable, Wave Solderable
- Current Limiting, Surface Mount and Tape & Reel Versions Available

APPROVALS

- UL Recognized: File Number E76270
- CSA Certified: File Number LR 43639-10
- BSI Certified to:
 - BS EN 60950:1992 (BS7002:1992)
Certificate #: 7344
 - BS EN 41003:1993
Certificate #: 7344

OPTIONS / SUFFIXES

- P: Flatpack Package
- S: Surface Mount Package
- TR: Tape & Reel

Switching Characteristics of Normally Closed (Form B) Devices

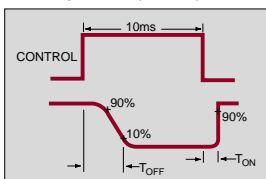

APPLICATIONS

- Telecommunications
 - Telecom Switching
 - Tip/Ring Circuits
 - Modem Switching (Laptop, Notebook, Pocket Size)
 - Hookswitch
 - Dial Pulsing
 - Ground Start
 - Ringer Injection
- Instrumentation
 - Multiplexers
 - Data Acquisition
 - Electronic Switching
 - I/O Subsystems
 - Meters (Watt-Hour, Water, Gas)
- Medical Equipment—Patient/Equipment Isolation
- Security
- Aerospace
- Industrial Controls

RATINGS (@ 25° C)

Parameter	Min	Typ	Max	Units
Input Power Dissipation	-	-	150 ¹	mW
Input Control Current	-	-	50	mA
Peak (10ms)	-	-	1	A
Reverse Input Voltage	-	-	5	V
Total Power Dissipation	-	-	800 ²	mW
Capacitance				
Input to Output	-	3	-	pF
Isolation Voltage				
Input to Output	3750	-	-	V _{RMS}
Operational Temperature	-40	-	+85	°C
Storage Temperature	-40	-	+125	°C
Soldering Temperature				
(10 Seconds Max.)				
DIP Package	-	-	+260	°C
Flatpack/Surface Mount Package	-	-	+220	°C

¹ Derate Linearly 1.33 mW/°C

² Derate Linearly 1.67 mW/°C

Note: For Mechanical Dimensions See Pages 396-401

SPECIFICATIONS

PARAMETERS	CONDITIONS	SYMBOL	MIN	TYP	MAX	UNITS
Output Characteristics @ 25°C						
Load Voltage (Peak)	-	V_L	-	-	350	V
Load Current* (Continuous) AC/DC Configuration	-	I_L	-	-	120	mA
Peak Load Current	10ms	I_{LPK}	-	-	350	mA
On-Resistance AC/DC Configuration	$I_L=120mA$	R_{ON}	-	25	35	Ω
Off-State Leakage Current	$V_L=350mA$	-	-	-	1	μA
Switching Speeds						
Turn-On	$I_F=5mA, V_L=10V$	T_{ON}	-	-	3	ms
Turn-Off	$I_F=5mA, V_L=10V$	T_{OFF}	-	-	3	ms
Output Capacitance	50V; f=1MHz	C_{OUT}	-	25	-	pF
Input Characteristics @ 25°C						
Input Control Current	$I_L=120mA$	I_F	5	-	50	mA
Input Dropout Current	-	I_F	0.4	0.7	-	mA
Input Voltage Drop	$I_F=5mA$	V_F	0.9	1.2	1.4	V
Reverse Input Voltage	-	V_R	-	-	5	V
Reverse Input Current	$V_R=5V$	I_R	-	-	10	μA
Input to Output Capacitance	-	$V_{C/O}$	-	3	-	pF
Input to Output Isolation	-	$V_{I/O}$	3750	-	-	V_{RMS}

*Note: If both poles operate simultaneously load current must be derated so as not to exceed the package power dissipation value.

LBB110 Pinout

AC/DC Configuration

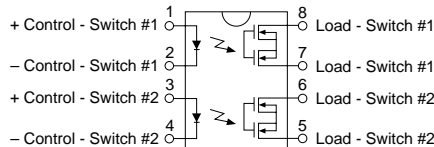

Note: For Mechanical Dimensions See Pages 396-401

PERFORMANCE DATA

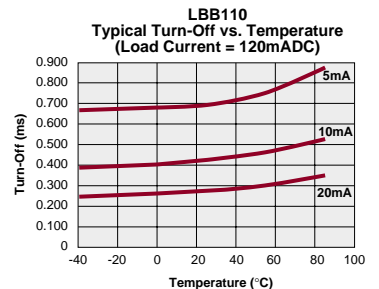
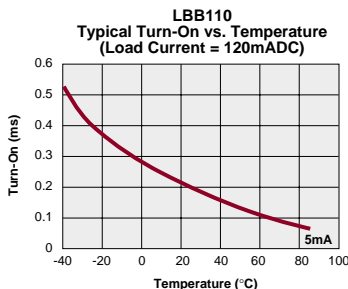
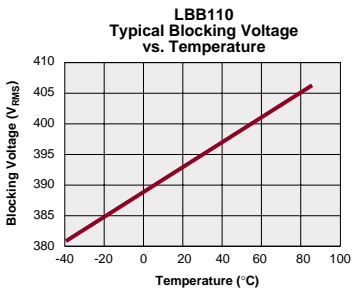
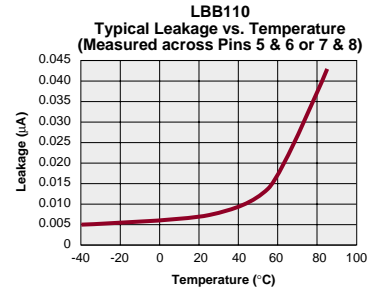
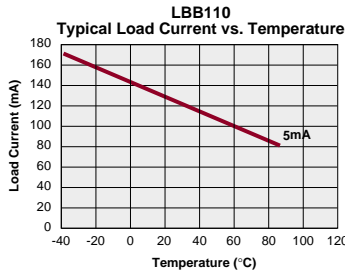
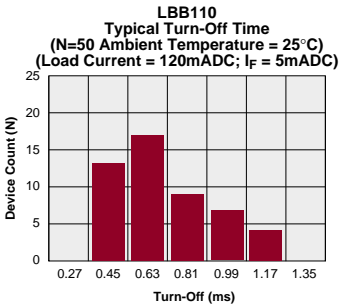
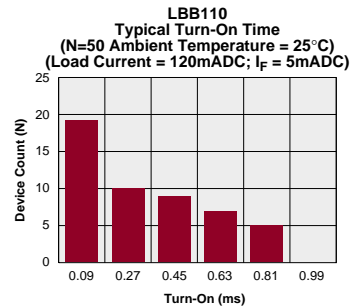
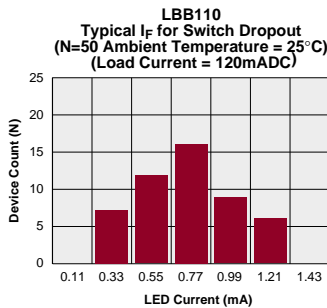
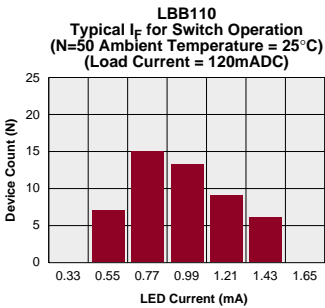
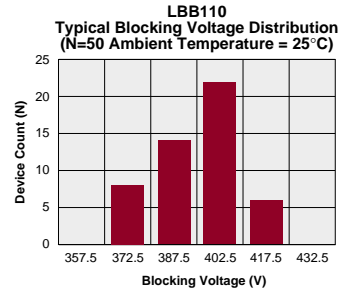
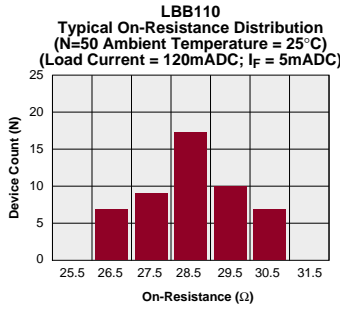
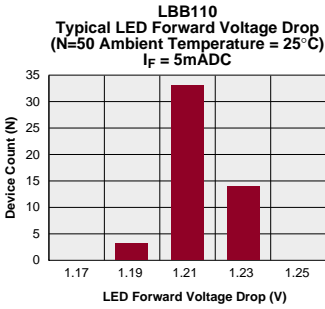

LBB110

PERFORMANCE DATA

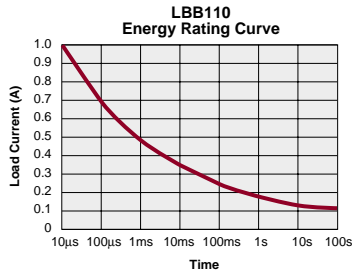
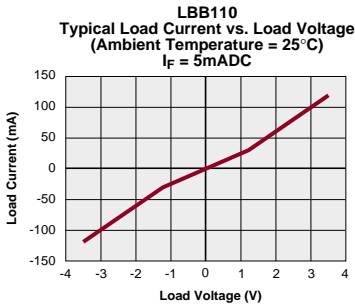
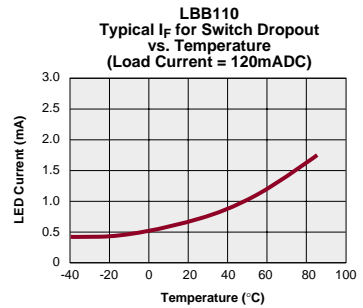
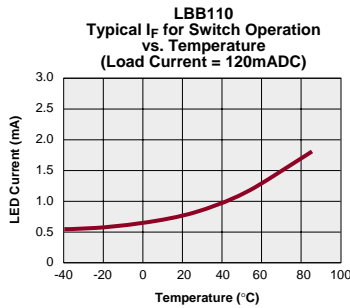
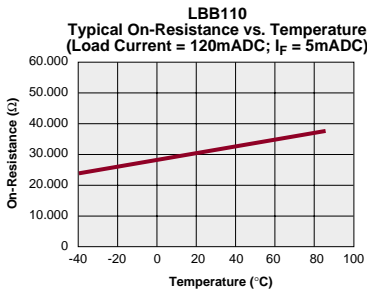
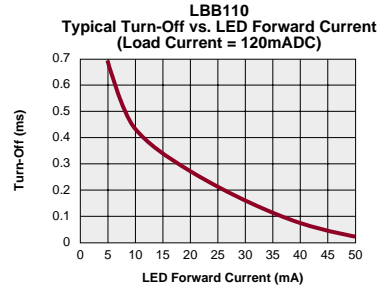
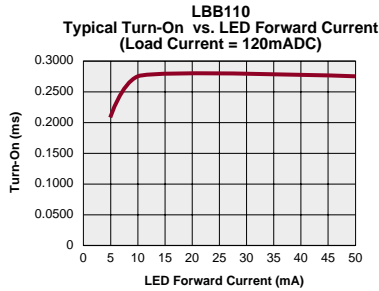
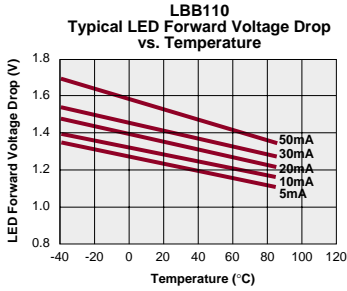



DESCRIPTION

The XBB170 is a 350V, 120mA, 50Ω type 2-Form-B solid state relay.

FEATURES

- Small 8 Pin DIP Package
- Low Drive Power Requirements (TTL/CMOS Compatible)
- No Moving Parts
- High Reliability
- Arc-Free With No Snubbing Circuits
- 3750V_{RMS} Input/Output Isolation
- FCC Compatible
- VDE Compatible
- No EMI/RFI Generation
- Machine Insertable, Wave Solderable
- Current Limiting, Surface Mount and Tape & Reel Versions Available

APPROVALS

- UL Recognized: File Number E76270
- CSA Certified: File Number LR 43639-10
- BSI Certified to:
 - BS EN 60950:1992 (BS7002:1992)
Certificate #: 7344
 - BS EN 41003:1993
Certificate #: 7344

OPTIONS / SUFFIXES

- P: Flatpack Package
- S: Surface Mount Package
- TR: Tape & Reel

Switching Characteristics of Normally Closed (Form B) Devices

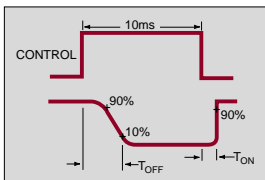

APPLICATIONS

- Telecommunications
 - Telecom Switching
 - Tip/Ring Circuits
 - Modem Switching (Laptop, Notebook, Pocket Size)
 - Hookswitch
 - Dial Pulsing
 - Ground Start
 - Ringer Injection
- Instrumentation
 - Multiplexers
 - Data Acquisition
 - Electronic Switching
 - I/O Subsystems
 - Meters (Watt-Hour, Water, Gas)
- Medical Equipment—Patient/Equipment Isolation
- Security
- Aerospace
- Industrial Controls

RATINGS (@ 25° C)

Parameter	Min	Typ	Max	Units
Input Power Dissipation	-	-	150 ¹	mW
Input Control Current	-	-	50	mA
Peak (10ms)	-	-	1	A
Reverse Input Voltage	-	-	5	V
Total Power Dissipation	-	-	800 ²	mW
Capacitance				
Input to Output	-	3	-	pF
Isolation Voltage				
Input to Output	3750	-	-	V _{RMS}
Operational Temperature	-40	-	+85	°C
Storage Temperature	-40	-	+125	°C
Soldering Temperature (10 Seconds Max.)				
DIP Package	-	-	+260	°C
Surface Mount Package	-	-	+220	°C

¹ Derate Linearly 1.33 mW/°C

² Derate Linearly 1.67 mW/°C

Note: For Mechanical Dimensions See Pages 396-401

SPECIFICATIONS

PARAMETERS	CONDITIONS	SYMBOL	MIN	TYP	MAX	UNITS
Output Characteristics @ 25°C						
Load Voltage (Peak)	-	V_L	-	-	350	V
Load Current* (Continuous) AC/DC Configuration	-	I_L	-	-	100	mA
Peak Load Current	10ms	I_{LPK}	-	-	350	mA
On-Resistance AC/DC Configuration	$I_L=120mA$	R_{ON}	-	33	50	Ω
Off-State Leakage Current	$V_L=350mA$	-	-	-	1	μA
Switching Speeds						
Turn-On	$I_F = 5mA, V_L=10V$	T_{ON}	-	-	5	ms
Turn-Off	$I_F = 5mA, V_L=10V$	T_{OFF}	-	-	5	ms
Output Capacitance	50V; f = 1MHz	C_{OUT}	-	25	-	pF
Input Characteristics @ 25°C						
Input Control Current	$I_L = 120mA$	I_F	5	-	50	mA
Input Dropout Current	-	I_F	0.4	0.7	-	mA
Input Voltage Drop	$I_F = 5mA$	V_F	0.9	1.2	1.4	V
Reverse Input Voltage	-	V_R	-	-	5	V
Reverse Input Current	$V_R = 5V$	I_R	-	-	10	μA
Input to Output Capacitance	-	$V_{C/O}$	-	3	-	pF
Input to Output Isolation	-	$V_{I/O}$	3750	-	-	V_{RMS}

*Note: If both poles operate simultaneously load current must be derated so as not to exceed the package power dissipation value.

XBB170 Pinout

AC/DC Configuration

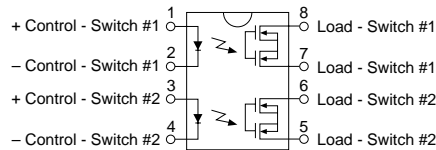

Note: For Mechanical Dimensions See Pages 396-401

PERFORMANCE DATA

XBB170
Typical LED Forward Voltage Drop
(N=50 Ambient Temperature = 25°C)
I_F = 5mADC

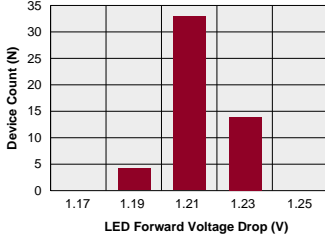

XBB170
Typical On-Resistance Distribution
(N=50 Ambient Temperature = 25°C)
(Load Current = 100mADC)

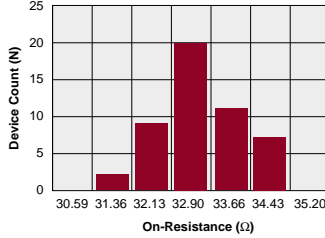

XBB170
Typical Blocking Voltage Distribution
(N=50 Ambient Temperature = 25°C)

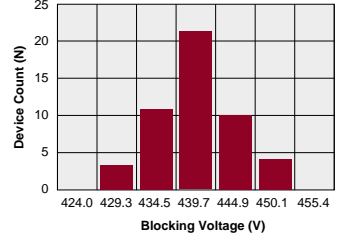

XBB170
Typical I_F for Switch Operation
(N=50 Ambient Temperature = 25°C)
(Load Current = 100mADC)

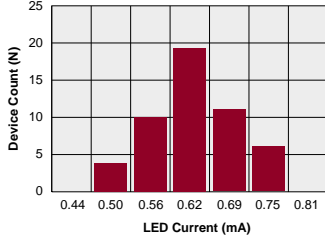

XBB170
Typical I_F for Switch Dropout
(N=50 Ambient Temperature = 25°C)
(Load Current = 100mADC)

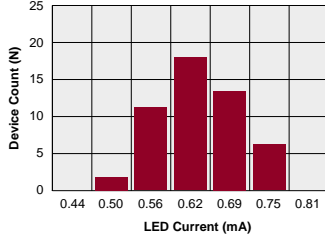

XBB170
Typical Turn-On Time
(N=50 Ambient Temperature = 25°C)
(Load Current = 100mADC)

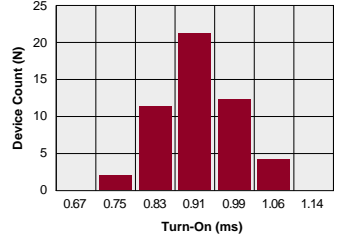

XBB170
Typical Turn-Off Time
(N=50 Ambient Temperature = 25°C)
(Load Current = 100mADC)

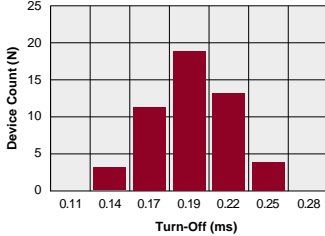

XBB170
Typical Load Current vs. Temperature

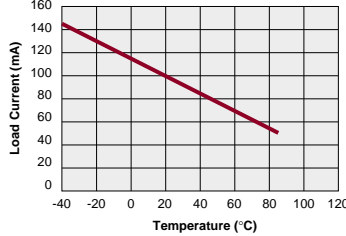

XBB170
Typical Leakage vs. Temperature
(Measured across Pins 4 & 6)

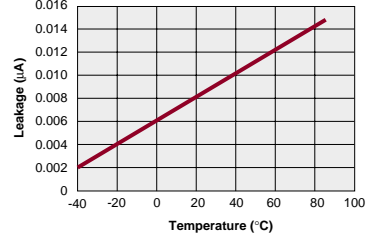

XBB170
Typical Blocking Voltage vs. Temperature

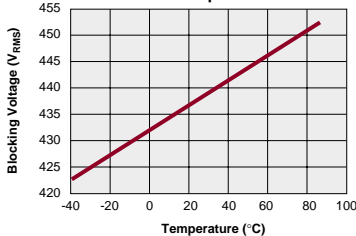

XBB170
Typical Turn-On vs. Temperature
(Load Current = 100mADC)

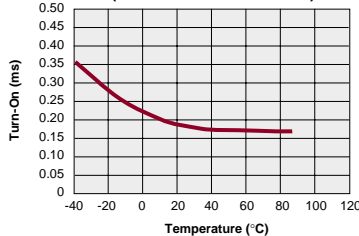

XBB170
Typical Turn-Off vs. Temperature
(Load Current = 100mADC)

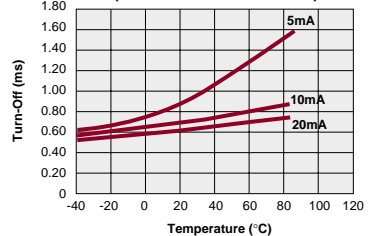

PERFORMANCE DATA

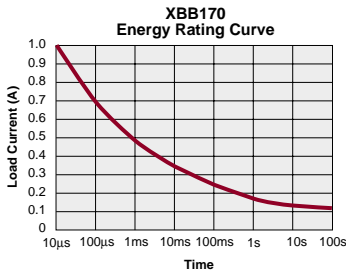
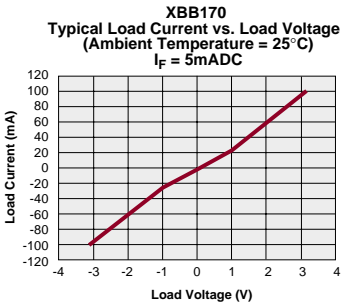
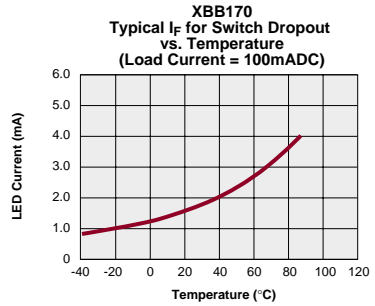
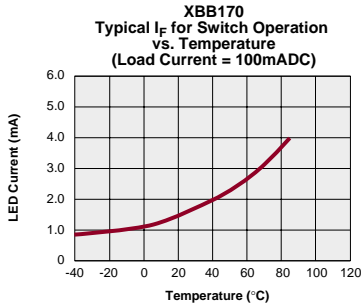
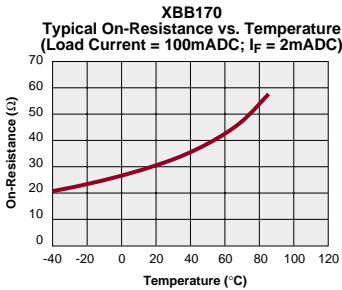
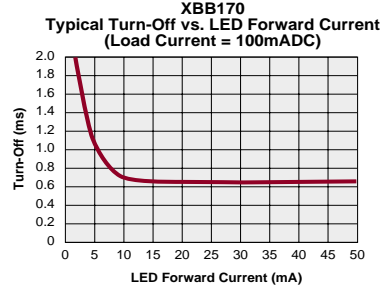
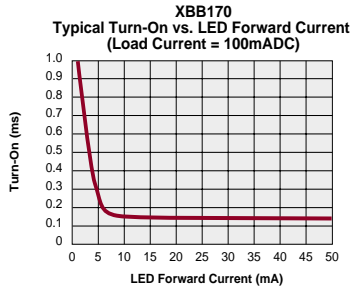
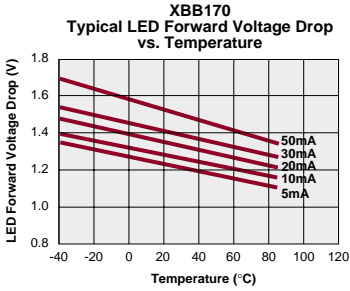



DESCRIPTION

The LBB120 is a 250V, 170mA, 20Ω type 2-Form-B solid state relay.

FEATURES

- Small 8 Pin DIP Package
- Low Drive Power Requirements (TTL/CMOS Compatible)
- No Moving Parts
- High Reliability
- Arc-Free With No Snubbing Circuits
- 3750V_{RMS} Input/Output Isolation
- FCC Compatible
- VDE Compatible
- No EMI/RFI Generation
- Machine Insertable, Wave Solderable
- Current Limiting, Surface Mount and Tape & Reel Versions Available

APPROVALS

- UL Recognized: File Number E76270
- CSA Certified: File Number LR 43639-10
- BSI Certified to:
 - BS EN 60950:1992 (BS7002:1992)
Certificate #: 7344
 - BS EN 41003:1993
Certificate #: 7344

OPTIONS / SUFFIXES

- P: Flatpack Package
- S: Surface Mount Package
- TR: Tape & Reel

Switching Characteristics of Normally Closed (Form B) Devices

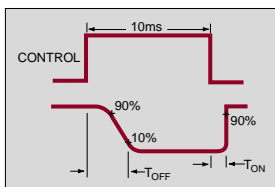

APPLICATIONS

- Telecommunications
 - Telecom Switching
 - Tip/Ring Circuits
 - Modem Switching (Laptop, Notebook, Pocket Size)
 - Hookswitch
 - Dial Pulsing
 - Ground Start
 - Ringer Injection
- Instrumentation
 - Multiplexers
 - Data Acquisition
 - Electronic Switching
 - I/O Subsystems
 - Meters (Watt-Hour, Water, Gas)
- Medical Equipment—Patient/Equipment Isolation
- Security
- Aerospace
- Industrial Controls

RATINGS (@ 25° C)

Parameter	Min	Typ	Max	Units
Input Power Dissipation	-	-	150 ¹	mW
Input Control Current	-	-	50	mA
Peak (10ms)	-	-	1	A
Reverse Input Voltage	-	-	5	V
Total Power Dissipation	-	-	800 ²	mW
Capacitance				
Input to Output	-	3	-	pF
Isolation Voltage				
Input to Output	3750	-	-	V _{RMS}
Operational Temperature	-40	-	+85	°C
Storage Temperature	-40	-	+125	°C
Soldering Temperature (10 Seconds Max.)				
DIP Package	-	-	+260	°C
Surface Mount Package	-	-	+220	°C

¹ Derate Linearly 1.33 mw/°C

² Derate Linearly 1.67 mw/°C

Note: For Mechanical Dimensions See Pages 396-401

SPECIFICATIONS

PARAMETERS	CONDITIONS	SYMBOL	MIN	TYP	MAX	UNITS
Output Characteristics @ 25°C						
Load Voltage (Peak)	-	V_L	-	-	250	V
Load Current* (Continuous) AC/DC Configuration	-	I_L	-	-	170	mA
Peak Load Current	10ms	I_L	-	-	400	mA
On-Resistance AC/DC Configuration	$I_L=120\text{mA}$	R_{ON}	-	16	20	Ω
Off-State Leakage Current	$V_L=250\text{V}$	-	-	-	1	μA
Switching Speeds						
Turn-On	$I_F=5\text{mA}, V_L=10\text{V}$	T_{ON}	-	-	5	ms
Turn-Off	$I_F=5\text{mA}, V_L=10\text{V}$	T_{OFF}	-	-	5	ms
Output Capacitance	50V; f=1MHz	-	-	50	-	pF
Input Characteristics @ 25°C						
Input Control Current	$I_L=170\text{mA}$	I_F	5	-	50	mA
Input Dropout Current	-	I_F	0.4	0.7	-	mA
Input Voltage Drop	$I_F=5\text{mA}$	V_F	0.9	1.2	1.4	V
Reverse Input Voltage	-	V_R	-	-	5	V
Reverse Input Current	$V_R=5\text{V}$	I_R	-	-	10	μA
Input to Output Capacitance	-	$V_{C/O}$	-	3	-	pF
Input to Output Isolation	-	$V_{I/O}$	3750	-	-	V_{RMS}

*Note: If both poles operate simultaneously load current must be derated so as not to exceed the package power dissipation value.

LBB120 Pinout

AC/DC Configuration

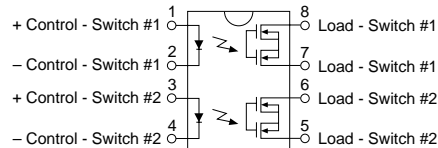

Note: For Mechanical Dimensions See Pages 396-401

PERFORMANCE DATA

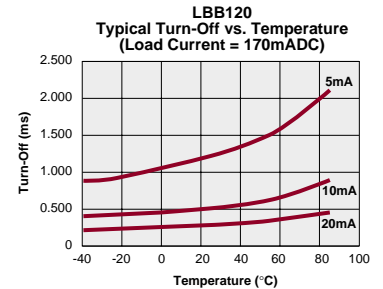
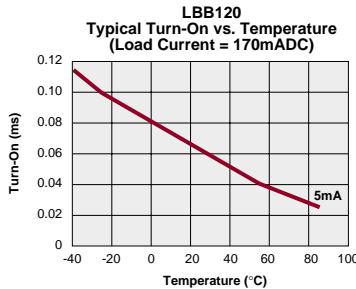
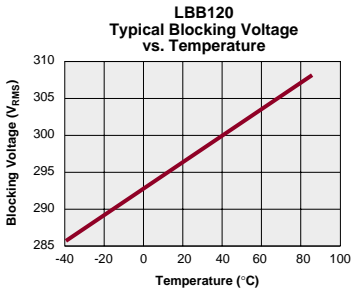
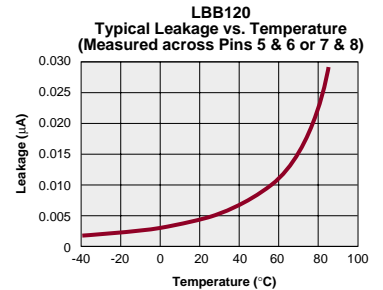
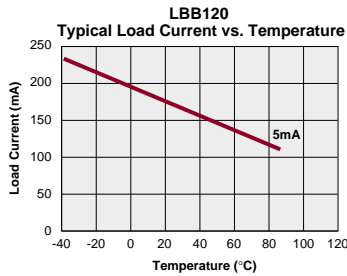
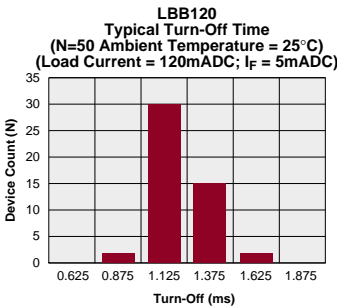
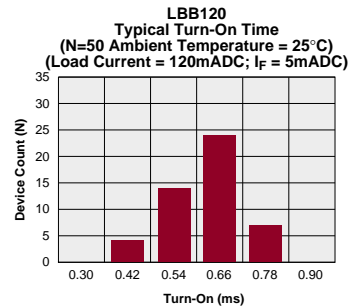
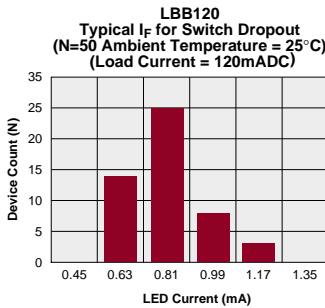
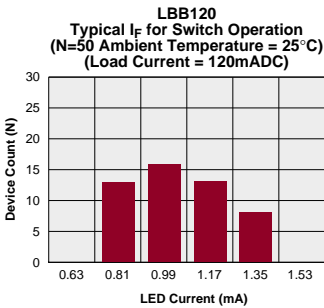
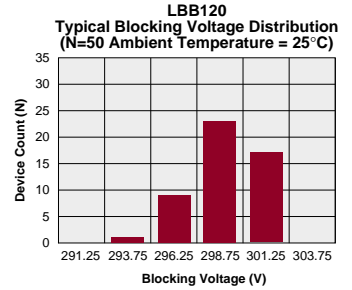
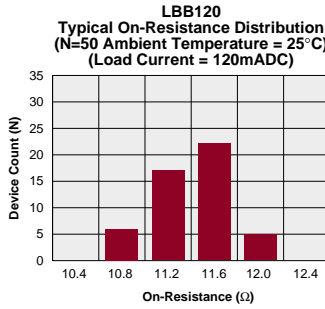
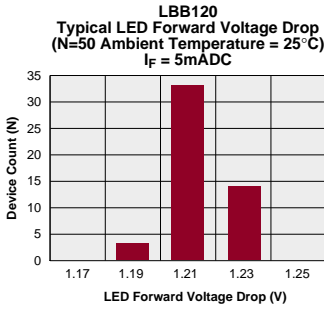

LBB120

PERFORMANCE DATA

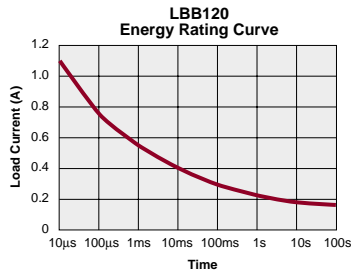
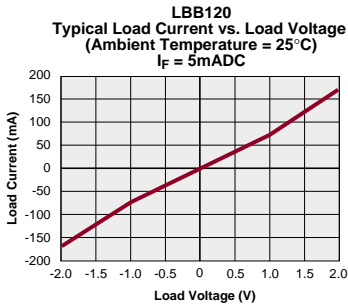
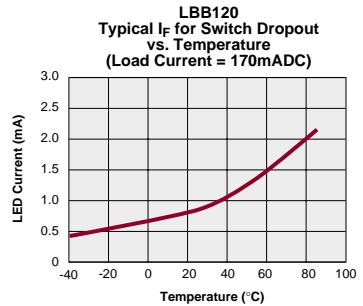
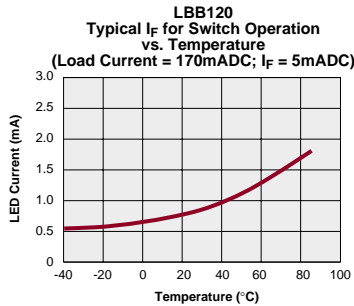
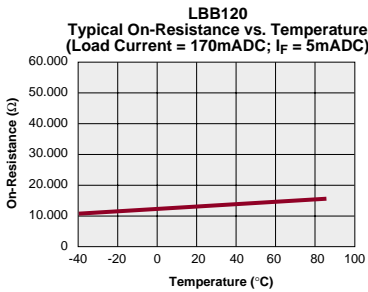
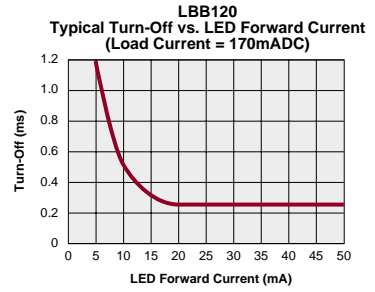
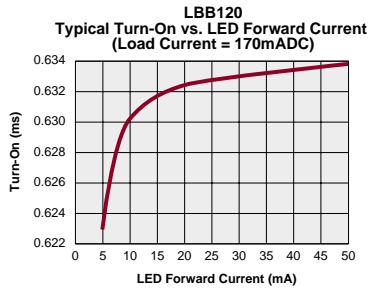
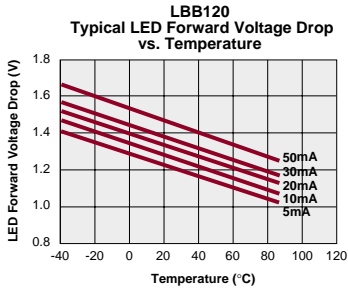



DESCRIPTION

The LBB126 is a 250V, 170mA, 15Ω type 2-Form-B solid state relay.

FEATURES

- Small 8 Pin DIP Package
- Low Drive Power Requirements (TTL/CMOS Compatible)
- No Moving Parts
- High Reliability
- Arc-Free With No Snubbing Circuits
- 3750V_{RMS} Input/Output Isolation
- FCC Compatible
- VDE Compatible
- No EMI/RFI Generation
- Machine Insertable, Wave Solderable
- Current Limiting, Surface Mount and Tape & Reel Versions Available

APPROVALS

- UL Recognized: File Number E76270
- CSA Certified: File Number LR 43639-10
- BSI Certified to:
 - BS EN 60950:1992 (BS7002:1992)
Certificate #: 7344
 - BS EN 41003:1993
Certificate #: 7344

OPTIONS / SUFFIXES

- P: Flatpack Package
- S: Surface Mount Package
- TR: Tape & Reel

Switching Characteristics of Normally Closed (Form B) Devices

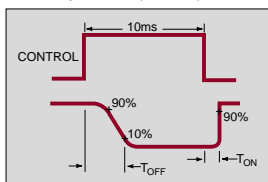

APPLICATIONS

- Telecommunications
 - Telecom Switching
 - Tip/Ring Circuits
 - Modem Switching (Laptop, Notebook, Pocket Size)
 - Hookswitch
 - Dial Pulsing
 - Ground Start
 - Ringer Injection
- Instrumentation
 - Multiplexers
 - Data Acquisition
 - Electronic Switching
 - I/O Subsystems
 - Meters (Watt-Hour, Water, Gas)
- Medical Equipment—Patient/Equipment Isolation
- Security
- Aerospace
- Industrial Controls

RATINGS (@ 25° C)

Parameter	Min	Typ	Max	Units
Input Power Dissipation	-	-	150 ¹	mW
Input Control Current	-	-	50	mA
Peak (10ms)	-	-	1	A
Reverse Input Voltage	-	-	5	V
Total Power Dissipation	-	-	800 ²	mW
Capacitance				
Input to Output	-	3	-	pF
Isolation Voltage				
Input to Output	3750	-	-	V _{RMS}
Operational Temperature	-40	-	+85	°C
Storage Temperature	-40	-	+125	°C
Soldering Temperature (10 Seconds Max.)				
DIP Package	-	-	+260	°C
Flatpack/Surface Mount Pkg	-	-	+220	°C

¹ Derate Linearly 1.33 mW/°C
² Derate Linearly 1.67 mW/°C

Note: For Mechanical Dimensions See Pages 396-401

SPECIFICATIONS

PARAMETERS	CONDITIONS	SYMBOL	MIN	TYP	MAX	UNITS
Output Characteristics @ 25°C						
Load Voltage (Peak)	-	V_L	-	-	250	V
Load Current* (Continuous) AC/DC Configuration	-	I_L	-	-	170	mA
Peak Load Current	10ms	I_{LPK}	-	-	400	mA
On-Resistance AC/DC Configuration	$I_L=170\text{mA}$	R_{ON}	-	10	15	Ω
Off-State Leakage Current	$V_L=350\text{mA}$	I_{LEAK}	-	-	1	μA
Switching Speeds						
Turn-On	$I_F=5\text{mA}, V_L=10\text{V}$	T_{ON}	-	-	5	ms
Turn-Off	$I_F=5\text{mA}, V_L=10\text{V}$	T_{OFF}	-	-	5	ms
Output Capacitance	50V; f=1MHz	C_{OUT}	-	50	-	pF
Input Characteristics @ 25°C						
Input Control Current	$I_L=170\text{mA}$	I_F	5	-	50	mA
Input Dropout Current	-	I_F	0.4	0.7	-	mA
Input Voltage Drop	$I_F=5\text{mA}$	V_F	0.9	1.2	1.4	V
Reverse Input Voltage	-	V_R	-	-	5	V
Reverse Input Current	$V_R=5\text{V}$	I_R	-	-	10	μA
Input to Output Capacitance	-	$C_{I/O}$	-	3	-	pF
Input to Output Isolation	-	$V_{I/O}$	3750	-	-	V_{RMS}

*Note: If both poles operate simultaneously load current must be derated so as not to exceed the package power dissipation value.

LBB126 Pinout

AC/DC Configuration

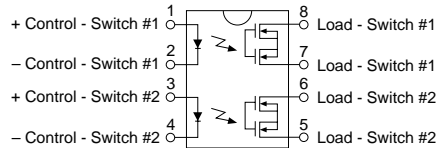

Note: For Mechanical Dimensions See Pages 396-401

PERFORMANCE DATA

LBB126
Typical LED Forward Voltage Drop
(N=50 Ambient Temperature = 25°C)
I_F = 5mADC

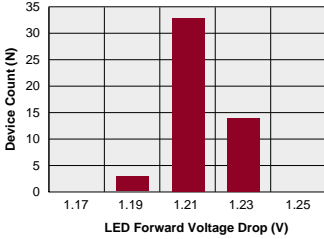

LBB126
Typical On-Resistance Distribution
(N=50 Ambient Temperature = 25°C)
(Load Current = 170mADC)

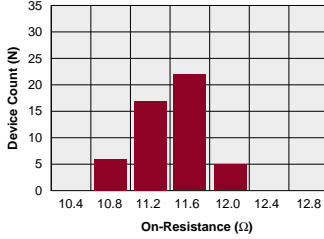

LBB126
Typical Blocking Voltage Distribution
(N=50 Ambient Temperature = 25°C)

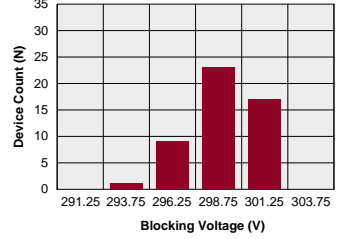

LBB126
Typical I_F for Switch Operation
(N=50 Ambient Temperature = 25°C)
(Load Current = 170mADC)

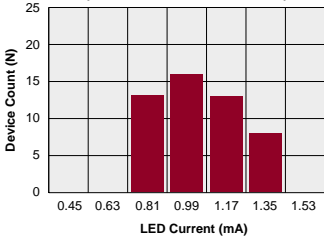

LBB126
Typical I_F for Switch Dropout
(N=50 Ambient Temperature = 25°C)
(Load Current = 170mADC)

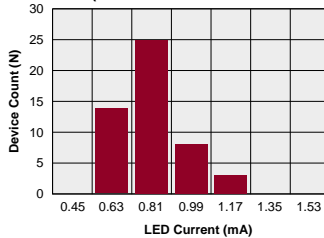

LBB126
Typical Turn-On Time
(N=50 Ambient Temperature = 25°C)
(Load Current = 170mADC; I_F = 5mADC)

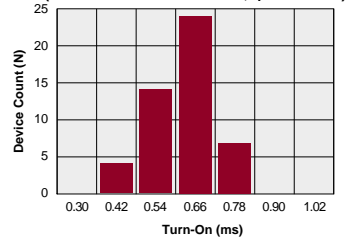

LBB126
Typical Turn-Off Time
(N=50 Ambient Temperature = 25°C)
(Load Current = 170mADC; I_F = 5mADC)

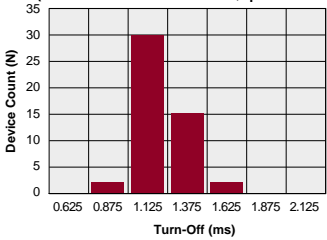

LBB126
Typical Load Current vs. Temperature

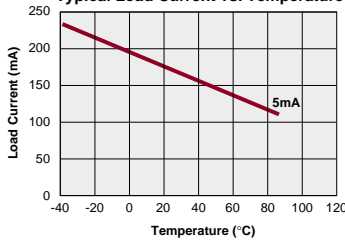

LBB126
Typical Leakage vs. Temperature
(Measured across Pins 5 & 6 or 7 & 8)

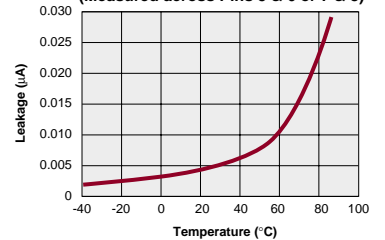

LBB126
Typical Blocking Voltage vs. Temperature

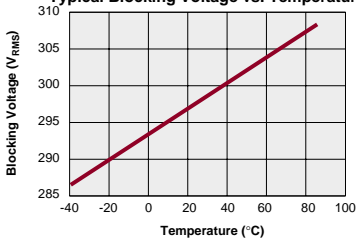

LBB126
Typical Turn-On vs. Temperature
(Load Current = 170mADC)

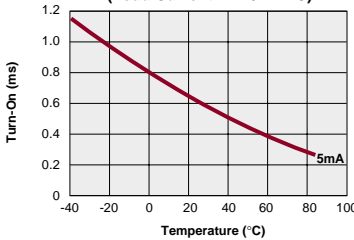

LBB126
Typical Turn-Off vs. Temperature
(Load Current = 170mADC)

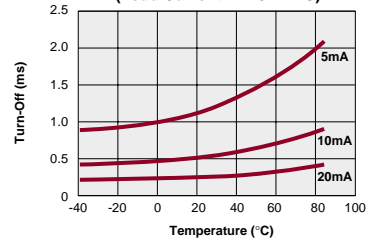

LBB126

PERFORMANCE DATA

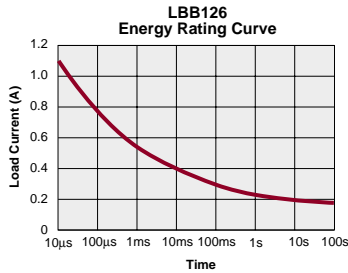
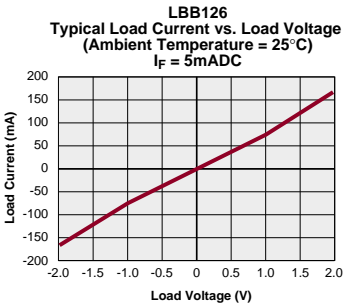
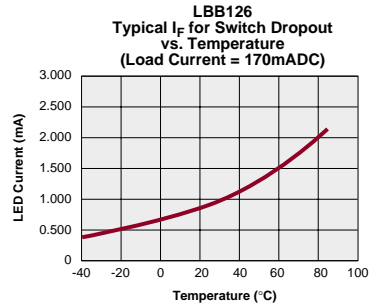
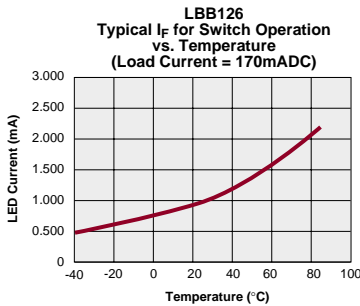
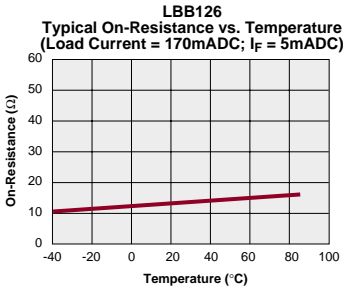
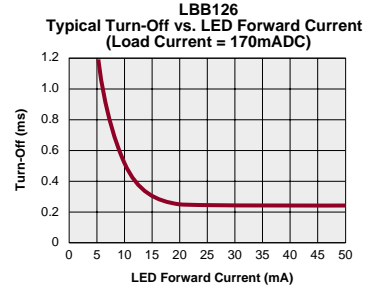
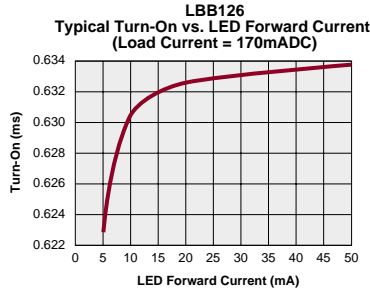
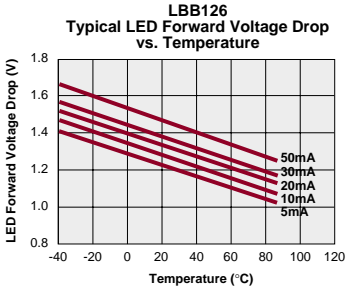



DESCRIPTION

The LBB127 is a 250V, 200mA, 10Ω type 2-Form-B solid state relay.

FEATURES

- Small 8 Pin DIP Package
- Low Drive Power Requirements (TTL/CMOS Compatible)
- No Moving Parts
- High Reliability
- Arc-Free With No Snubbing Circuits
- 3750V_{RMS} Input/Output Isolation
- FCC Compatible
- VDE Compatible
- No EMI/RFI Generation
- Machine Insertable, Wave Solderable
- Current Limiting, Surface Mount and Tape & Reel Versions Available

APPROVALS

- UL Recognized: File Number E76270
- CSA Certified: File Number LR 43639-10
- BSI Certified to:
 - BS EN 60950:1992 (BS7002:1992)
Certificate #: 7344
 - BS EN 41003:1993
Certificate #: 7344

OPTIONS / SUFFIXES

- P: Flatpack Package
- S: Surface Mount Package
- TR: Tape & Reel

Switching Characteristics of Normally Closed (Form B) Devices

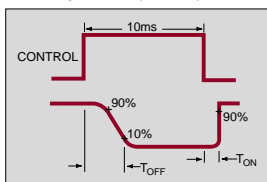

APPLICATIONS

- Telecommunications
 - Telecom Switching
 - Tip/Ring Circuits
 - Modem Switching (Laptop, Notebook, Pocket Size)
 - Hookswitch
 - Dial Pulsing
 - Ground Start
 - Ringer Injection
- Instrumentation
 - Multiplexers
 - Data Acquisition
 - Electronic Switching
 - I/O Subsystems
 - Meters (Watt-Hour, Water, Gas)
- Medical Equipment—Patient/Equipment Isolation
- Security
- Aerospace
- Industrial Controls

RATINGS (@ 25° C)

Parameter	Min	Typ	Max	Units
Input Power Dissipation	-	-	150 ¹	mW
Input Control Current	-	-	50	mA
Peak (10ms)	-	-	1	A
Reverse Input Voltage	-	-	5	V
Total Power Dissipation	-	-	800 ²	mW
Capacitance				
Input to Output	-	3	-	pF
Isolation Voltage				
Input to Output	3750	-	-	V _{RMS}
Operational Temperature	-40	-	+85	°C
Storage Temperature	-40	-	+125	°C
Soldering Temperature (10 Seconds Max.)				
DIP Package	-	-	+260	°C
Flatpack/Surface Mount Pkg	-	-	+220	°C

¹ Derate Linearly 1.33 mw/°C
² Derate Linearly 1.67 mw/°C

Note: For Mechanical Dimensions See Pages 396-401

SPECIFICATIONS

PARAMETERS	CONDITIONS	SYMBOL	MIN	TYP	MAX	UNITS
Output Characteristics @ 25°C						
Load Voltage (Peak)	-	V_L	-	-	250	V
Load Current* (Continuous) AC/DC Configuration	-	I_L	-	-	200	mA
Peak Load Current	10ms	I_L	-	-	400	mA
On-Resistance AC/DC Configuration	$I_L=200\text{mA}$	R_{ON}	-	8	10	Ω
Off-State Leakage Current	$V_L=350\text{mA}$	-	-	-	1	μA
Switching Speeds						
Turn-On	$I_F=5\text{mA}, V_L=10\text{V}$	T_{ON}	-	-	5	ms
Turn-Off	$I_F=5\text{mA}, V_L=10\text{V}$	T_{OFF}	-	-	5	ms
Output Capacitance	50V; f=1MHz	-	-	50	-	pF
Input Characteristics @ 25°C						
Input Control Current	$I_L=200\text{mA}$	I_F	5	-	50	mA
Input Dropout Current	-	I_F	0.4	0.7	-	mA
Input Voltage Drop	$I_F=5\text{mA}$	V_F	0.9	1.2	1.4	V
Reverse Input Voltage	-	V_R	-	-	5	V
Reverse Input Current	$V_R=5\text{V}$	I_R	-	-	10	μA
Input to Output Capacitance	-	$C_{I/O}$	-	3	-	pF
Input to Output Isolation	-	$V_{I/O}$	3750	-	-	V_{RMS}

*Note: If both poles operate simultaneously load current must be derated so as not to exceed the package power dissipation value.

LBB127 Pinout

AC/DC Configuration

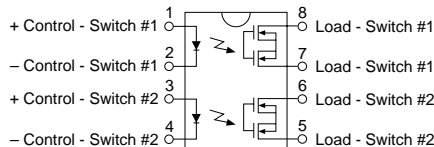

Note: For Mechanical Dimensions See Pages 396-401

PERFORMANCE DATA

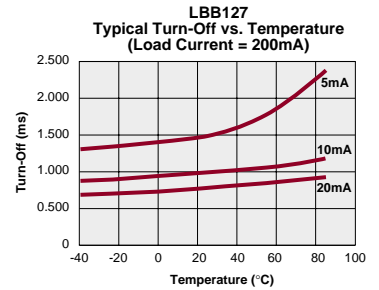
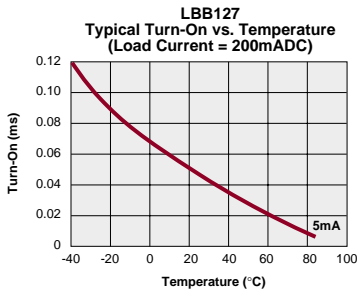
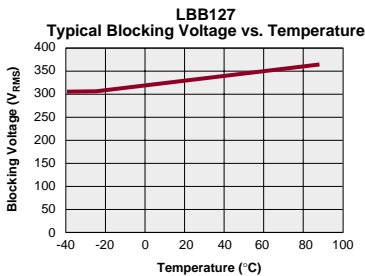
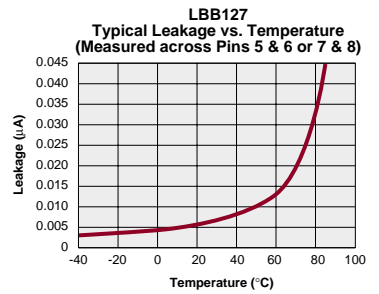
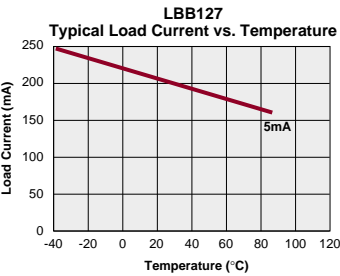
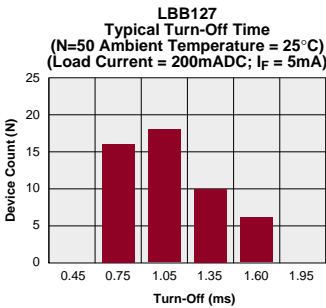
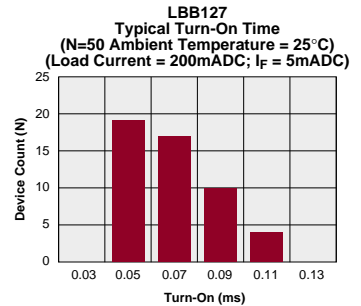
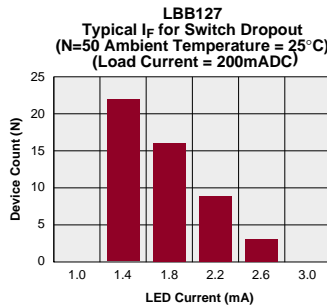
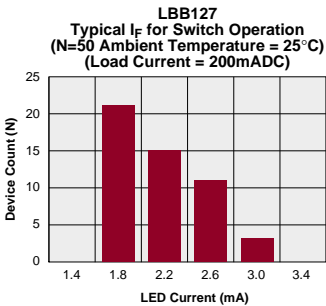
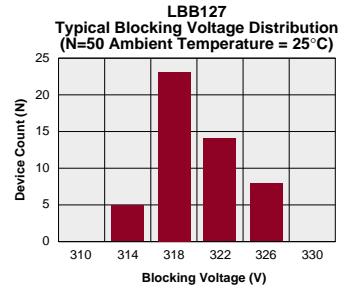
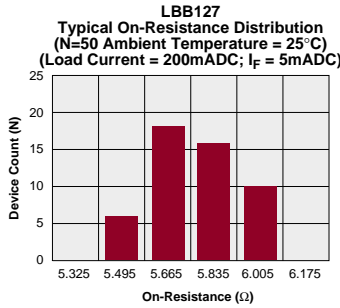
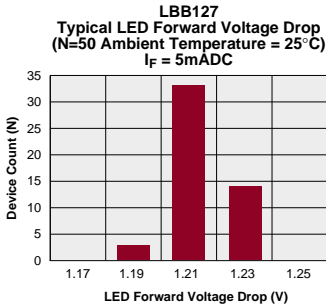

LBB127

PERFORMANCE DATA

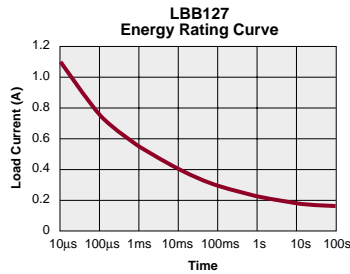
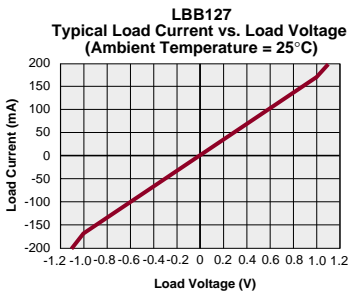
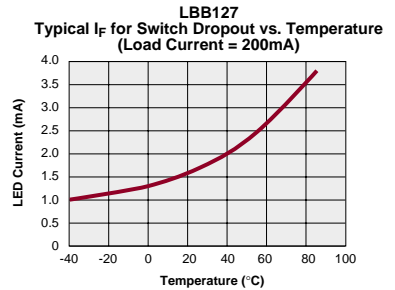
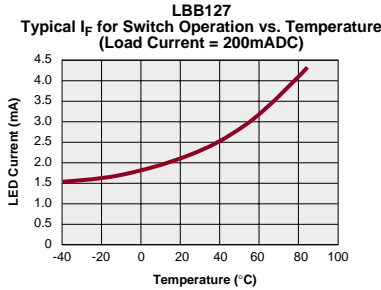
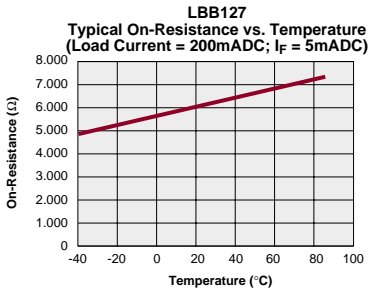
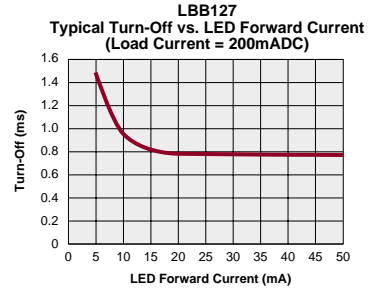
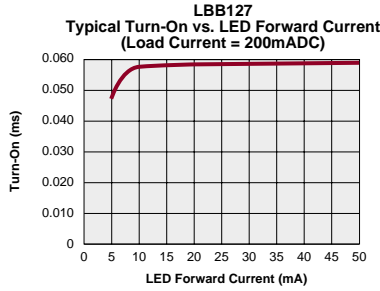
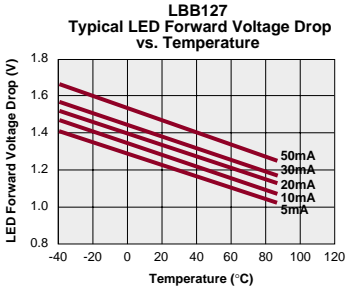



DESCRIPTION

The LCC110 is a 350V, 120mA, 35Ω type 1-Form-C solid state relay.

FEATURES

- Small 8 Pin DIP Package
- Low Drive Power Requirements (TTL/CMOS Compatible)
- No Moving Parts
- High Reliability
- Arc-Free With No Snubbing Circuits
- 3750V_{RMS} Input/Output Isolation
- FCC Compatible
- VDE Compatible
- No EMI/RFI Generation
- Machine Insertable, Wave Solderable
- Current Limiting, Surface Mount and Tape & Reel Versions Available

APPROVALS

- UL Recognized: File Number E76270
- CSA Certified: File Number LR 43639-10
- BSI Certified:
 - BS EN 60950:1992 (BS7002:1992) Certificate #:7344
 - BS EN 41003:1993 Certificate #:7344

OPTIONS / SUFFIXES

- S: Surface Mount Package
- TR: Tape & Reel

APPLICATIONS

- Telecommunications
 - Telecom Switching
 - Tip/Ring Circuits
 - Modem Switching (Laptop, Notebook, Pocket Size)
 - Hookswitch
 - Dial Pulsing
 - Ground Start
 - Ringer Injection
- Instrumentation
 - Multiplexers
 - Data Acquisition
 - Electronic Switching
 - I/O Subsystems
 - Meters (Watt-Hour, Water, Gas)
- Medical Equipment-Patient/Equipment Isolation
- Security
- Aerospace
- Industrial Controls

RATINGS (@ 25° C)

Parameter	Min	Typ	Max	Units
Input Power Dissipation	-	-	150 ¹	mW
Input Control Current	-	-	50	mA
Peak (10ms)	-	-	1	A
Reverse Input Voltage	-	-	5	V
Total Power Dissipation	-	-	800 ²	mW
Capacitance				
Input to Output	-	3	-	pF
Isolation Voltage				
Input to Output	3750	-	-	V _{RMS}
Operational Temperature	-40	-	+85	°C
Storage Temperature	-40	-	+125	°C
Soldering Temperature				
(10 Seconds Max.)				
DIP Package	-	-	+260	°C
Surface Mount Package	-	-	+220	°C

¹ Derate Linearly 1.33 mW/°C
² Derate Linearly 1.67 mW/°C

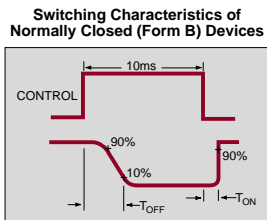
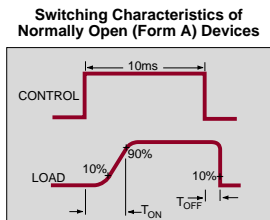

Note: For Mechanical Dimensions See Pages 396-401

www.cpclare.com

SPECIFICATIONS

PARAMETERS	CONDITIONS	SYMBOL	MIN	TYP	MAX	UNITS
Output Characteristics @ 25°C						
Load Voltage (Peak)	-	V_L	-	-	350	V
Load Current* (Continuous) AC/DC Configuration	-	I_L	-	-	120	mA
Peak Load Current	10ms	I_{LPK}	-	-	350	mA
On-Resistance AC/DC Configuration	$I_L=120\text{mA}$	R_{ON}	-	23	35	Ω
Off-State Leakage Current	$V_L=350\text{V}$	I_{LEAK}	-	-	1	μA
Switching Speeds						
Turn-On	$I_F=8\text{mA}, V_L=10\text{V}$	T_{ON}	-	-	4	ms
Turn-Off	$I_F=8\text{mA}, V_L=10\text{V}$	T_{OFF}	-	-	4	ms
Output Capacitance	50V; f=1MHz	C_{OUT}	-	25	-	pF
Input Characteristics @ 25°C						
Input Control Current	$I_L=120\text{mA}$	I_F	8	-	50	mA
Input Dropout Current	-	I_F	0.4	0.7	-	mA
Input Voltage Drop	$I_F=8\text{mA}$	V_F	0.9	1.2	1.4	V
Reverse Input Voltage	-	V_R	-	-	5	V
Reverse Input Current	$V_R=5\text{V}$	I_R	-	-	10	μA
Input to Output Capacitance	-	$C_{I/O}$	-	3	-	pF
Input to Output Isolation	-	$V_{I/O}$	3750	-	-	V_{RMS}

*NOTE: If both poles operate simultaneously load current must be derated so as not to exceed the package power dissipation value.

LCC110 Pinout

AC/DC Configuration

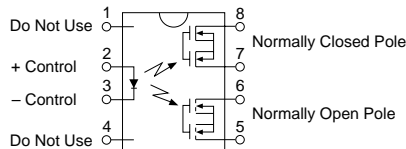

Note: For Mechanical Dimensions See Pages 396-401

PERFORMANCE DATA

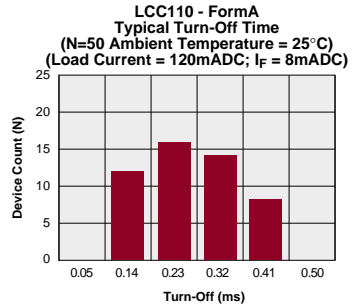
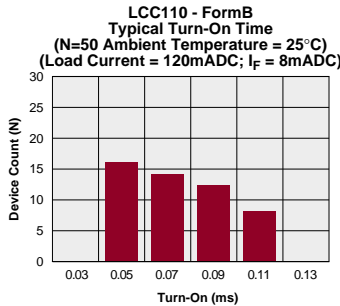
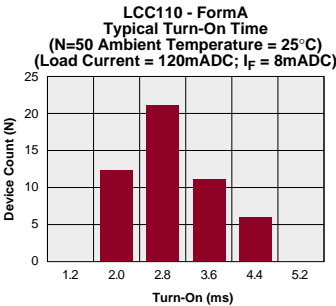
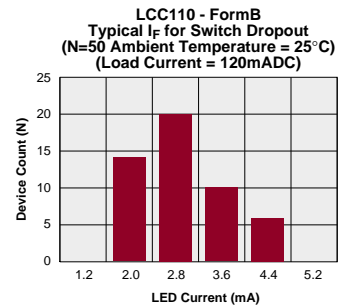
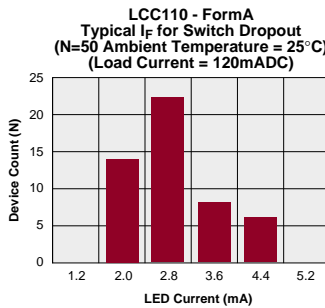
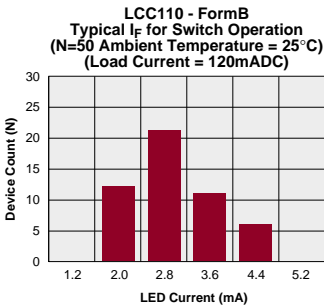
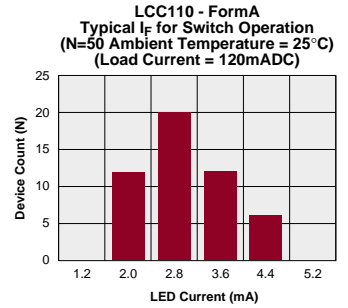
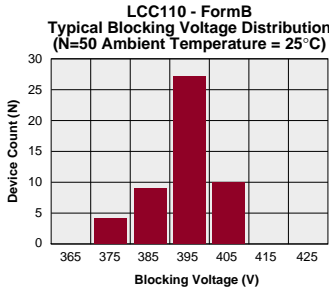
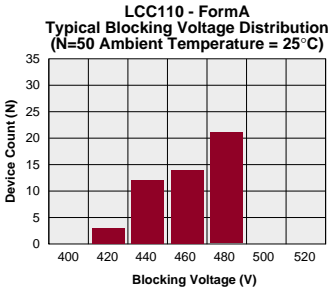
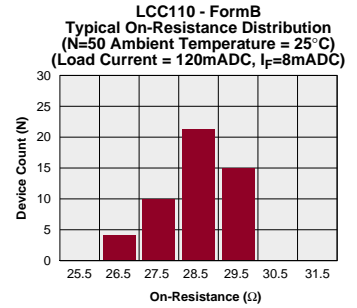
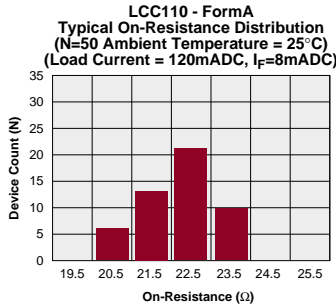
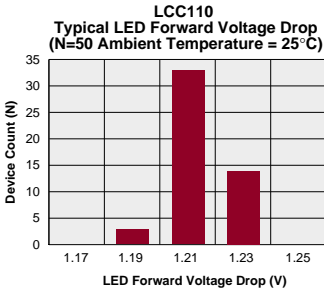

LCC110

PERFORMANCE DATA

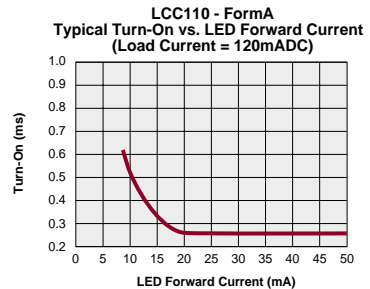
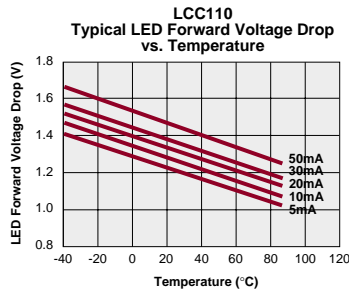
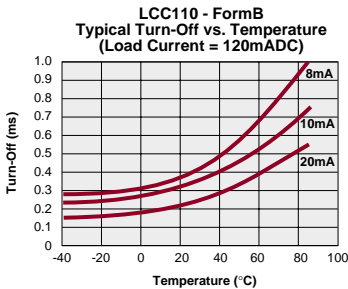
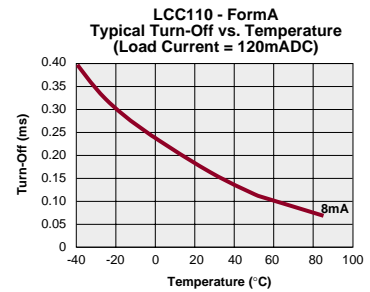
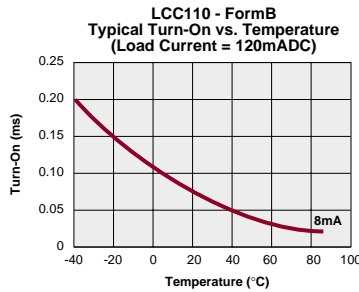
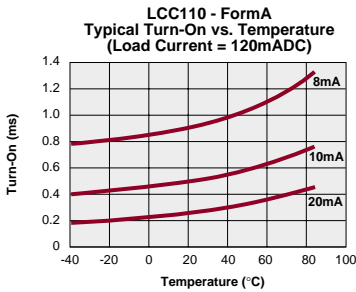
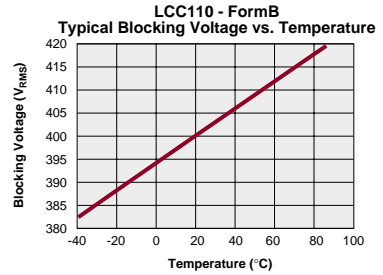
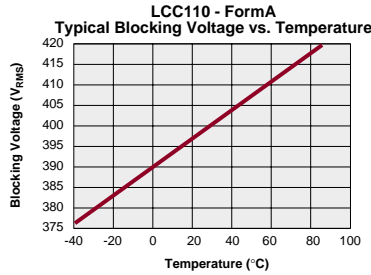
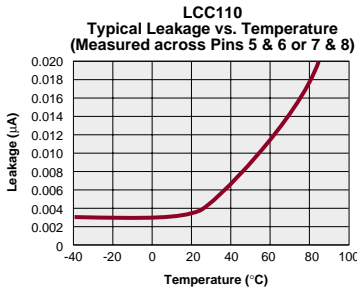
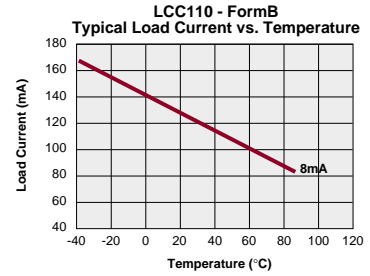
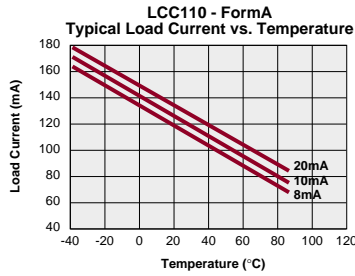
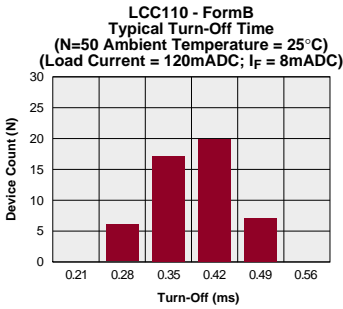

PERFORMANCE DATA

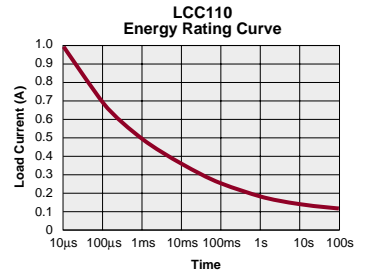
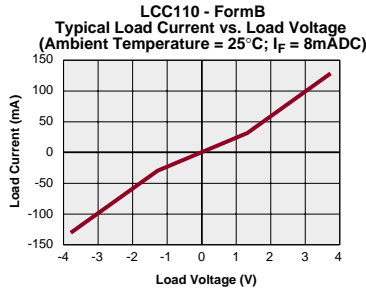
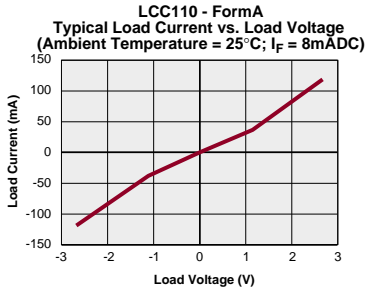
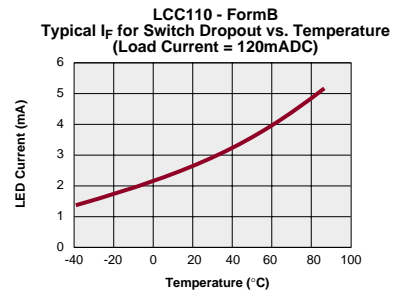
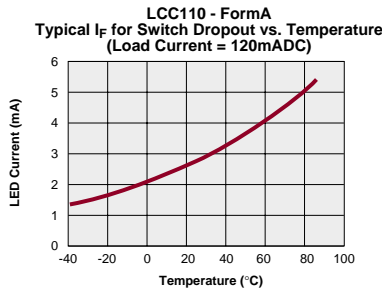
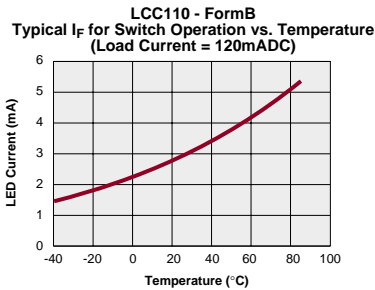
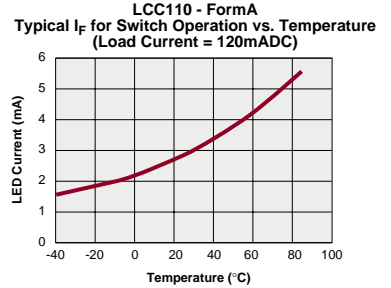
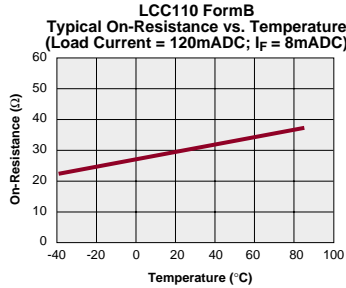
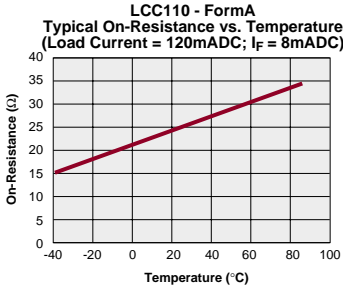
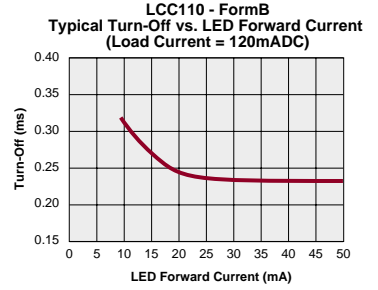
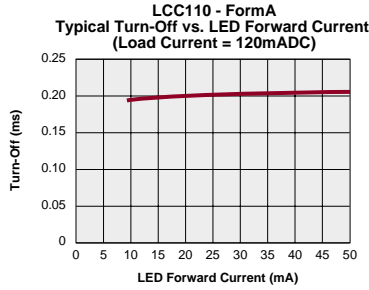
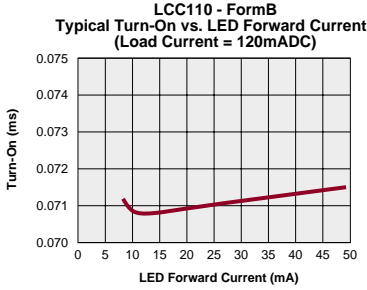

LCC120



DESCRIPTION

The LCC120 is a 250V, 170mA, 20Ω type 1-Form-C solid state relay.

FEATURES

- Small 8 Pin DIP Package
- Low Drive Power Requirements (TTL/CMOS Compatible)
- No Moving Parts
- High Reliability
- Arc-Free With No Snubbing Circuits
- 3750V_{RMS} Input/Output Isolation
- FCC Compatible
- VDE Compatible
- No EMI/RFI Generation
- Machine Insertable, Wave Solderable
- Current Limiting, Surface Mount and Tape & Reel Versions Available

APPROVALS

- UL Recognized: File Number E76270
- CSA Certified: File Number LR 43639-10
- BSI Certified:
 - BS EN 60950:1992 (BS7002:1992) Certificate #:7344
 - BS EN 41003:1993 Certificate #:7344

OPTIONS / SUFFIXES

- S: Surface Mount Package
- TR: Tape & Reel

Switching Characteristics of Normally Open (Form A) Devices

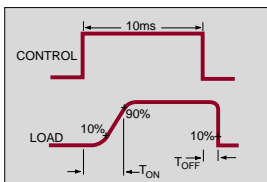

Switching Characteristics of Normally Closed (Form B) Devices

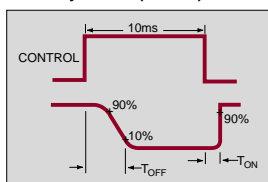

APPLICATIONS

- Telecommunications
 - Telecom Switching
 - Tip/Ring Circuits
 - Modem Switching (Laptop, Notebook, Pocket Size)
 - Hookswitch
 - Dial Pulsing
 - Ground Start
 - Ringer Injection
- Instrumentation
 - Multiplexers
 - Data Acquisition
 - Electronic Switching
 - I/O Subsystems
 - Meters (Watt-Hour, Water, Gas)
- Medical Equipment-Patient/Equipment Isolation
- Security
- Aerospace
- Industrial Controls

RATINGS (@ 25 °C)

Parameter	Min	Typ	Max	Units
Input Power Dissipation	-	-	150 ¹	mW
Input Control Current	-	-	50	mA
Peak (10ms)	-	-	1	A
Reverse Input Voltage	-	-	5	V
Total Power Dissipation	-	-	800 ²	mW
Capacitance				
Input to Output	-	3	-	pF
Isolation Voltage				
Input to Output	3750	-	-	V _{RMS}
Operational Temperature	-40	-	+85	°C
Storage Temperature	-40	-	+125	°C
Soldering Temperature				
(10 Seconds Max.)				
DIP Package	-	-	+260	°C
Surface Mount Package	-	-	+220	°C

¹ Derate Linearly 1.33 mw/°C

² Derate Linearly 1.67 mw/°C

Note: For Mechanical Dimensions See Pages 396-401

SPECIFICATIONS

PARAMETERS	CONDITIONS	SYMBOL	MIN	TYP	MAX	UNITS
Output Characteristics @ 25°C						
Load Voltage (Peak)	-	V_L	-	-	250	V
Load Current* (Continuous) AC/DC Configuration	-	I_L	-	-	170	mA
Peak Load Current	10ms	I_L	-	-	400	mA
On-Resistance AC/DC Configuration	$I_L=170mA$	R_{ON}	-	16	20	Ω
Off-State Leakage Current	$V_L=250V$	I_{LEAK}	-	-	1	μA
Switching Speeds						
Turn-On	$I_F=10mA, V_L=10V$	T_{ON}	-	-	5	ms
Turn-Off	$I_F=10mA, V_L=10V$	T_{OFF}	-	-	5	ms
Output Capacitance	50V; f=1MHz	C_{OUT}	-	50	-	pF
Input Characteristics @ 25°C						
Input Control Current	$I_L=170mA$	I_F	10	-	50	mA
Input Dropout Current	-	I_F	0.4	0.7	-	mA
Input Voltage Drop	$I_F=10mA$	V_F	0.9	1.2	1.4	V
Reverse Input Voltage	-	V_R	-	-	5	V
Reverse Input Current	$V_R=5V$	I_R	-	-	10	μA
Input to Output Capacitance	-	$C_{I/O}$	-	3	-	pF
Input to Output Isolation	-	$V_{I/O}$	3750	-	-	V_{RMS}

*NOTE: If both poles operate simultaneously load current must be derated so as not to exceed the package power dissipation value.

LCC120 Pinout

AC/DC Configuration

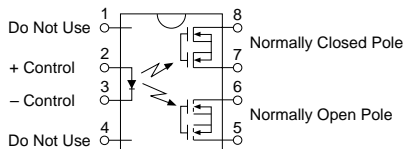

Note: For Mechanical Dimensions See Pages 396-401

www.cpcclare.com

PERFORMANCE DATA

LCC120
Typical LED Forward Voltage Drop
(N=50 Ambient Temperature = 25°C, I_f = 5mA)

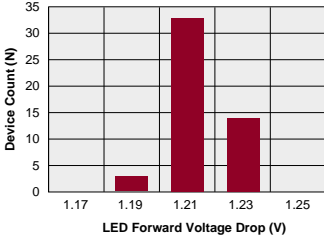

LCC120 - FormA
Typical On-Resistance Distribution
(N=50 Ambient Temperature = 25°C)
(Load Current = 170mADC, I_f=10mADC)

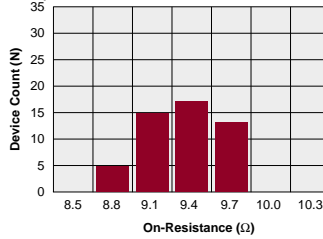

LCC120 - FormB
Typical On-Resistance Distribution
(N=50 Ambient Temperature = 25°C)
(Load Current = 170mADC, I_f=10mADC)

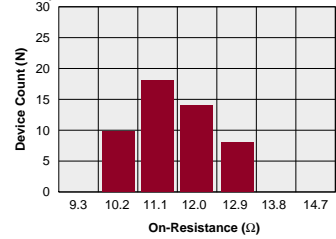

LCC120 - FormA
Typical Blocking Voltage Distribution
(N=50 Ambient Temperature = 25°C)

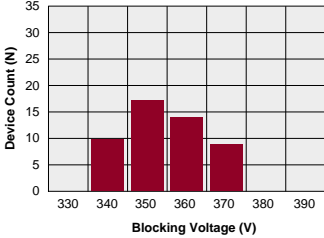

LCC120 - FormB
Typical Blocking Voltage Distribution
(N=50 Ambient Temperature = 25°C)

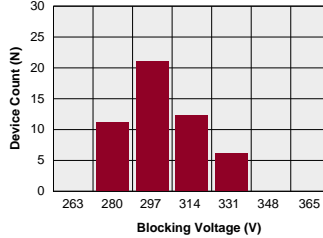

LCC120 - FormA
Typical I_f for Switch Operation
(N=50 Ambient Temperature = 25°C)
(Load Current = 170mADC)

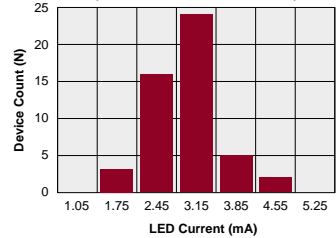

LCC120 - FormB
Typical I_f for Switch Operation
(N=50 Ambient Temperature = 25°C)
(Load Current = 170mADC)

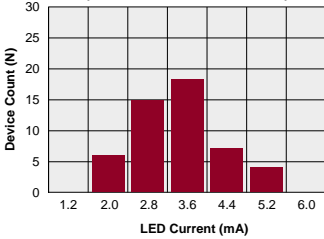

LCC120 - FormA
Typical I_f for Switch Dropout
(N=50 Ambient Temperature = 25°C)
(Load Current = 170mADC)

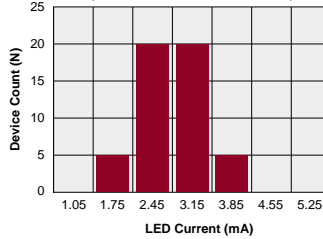

LCC120 - FormB
Typical I_f for Switch Dropout
(N=50 Ambient Temperature = 25°C)
(Load Current = 170mADC)

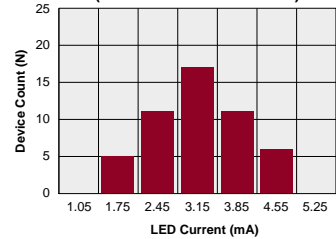

LCC120 - FormA
Typical Turn-On Time
(N=50 Ambient Temperature = 25°C)
(Load Current = 170mADC; I_f = 10mADC)

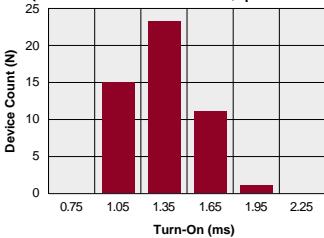

LCC120 - FormB
Typical Turn-On Time
(N=50 Ambient Temperature = 25°C)
(Load Current = 170mADC; I_f = 10mADC)

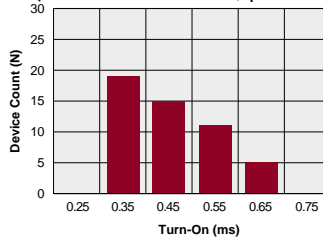

LCC120 - FormA
Typical Turn-Off Time
(N=50 Ambient Temperature = 25°C)
(Load Current = 170mADC; I_f = 10mADC)

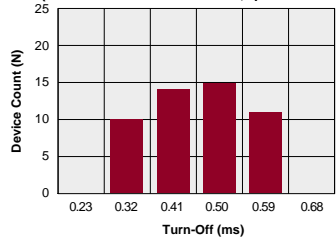

PERFORMANCE DATA

LCC120 - FormB
Typical Turn-Off Time
(N=50 Ambient Temperature = 25°C)
(Load Current = 170mADC; I_F = 10mADC)

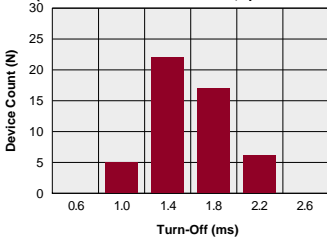

LCC120 - Form A
Typical Load Current vs. Temperature

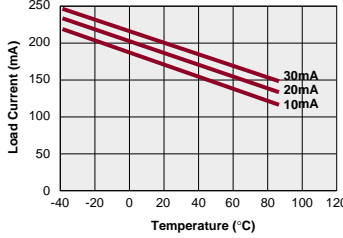

LCC120 - Form B
Typical Load Current vs. Temperature

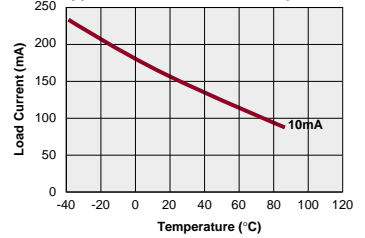

LCC120
Typical Leakage vs. Temperature
(Measured across Pins 5 & 6 or 7 & 8)

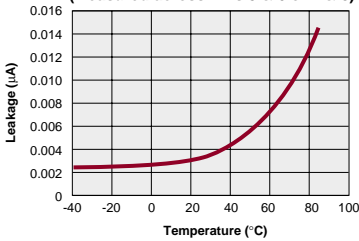

LCC120 - FormA
Typical Blocking Voltage vs. Temperature

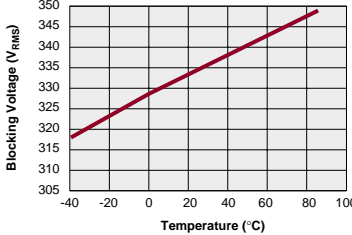

LCC120 - FormB
Typical Blocking Voltage vs. Temperature

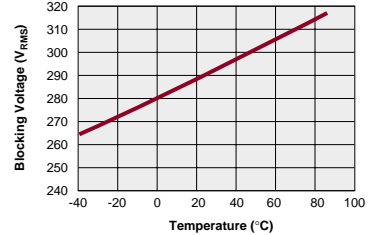

LCC120 - FormA
Typical Turn-On vs. Temperature
(Load Current = 170mADC)

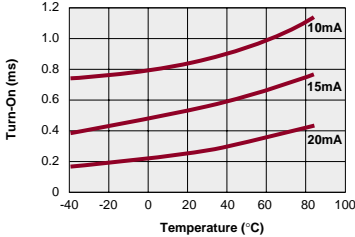

LCC120 - FormB
Typical Turn-On vs. Temperature
(Load Current = 170mADC)

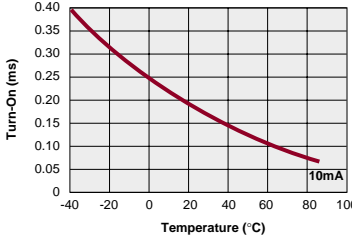

LCC120 - FormA
Typical Turn-Off vs. Temperature
(Load Current = 170mADC)

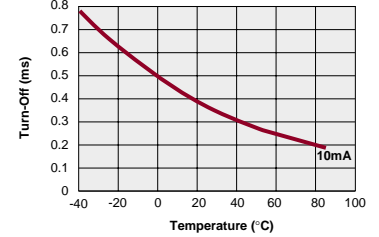

LCC120 - FormB
Typical Turn-Off vs. Temperature
(Load Current = 170mADC)

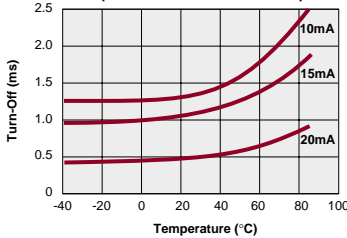

LCC120
Typical LED Forward Voltage Drop vs. Temperature

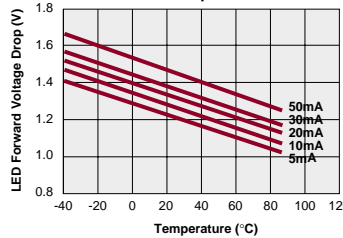

LCC120 - FormA
Typical Turn-On vs. LED Forward Current
(Load Current = 170mADC)

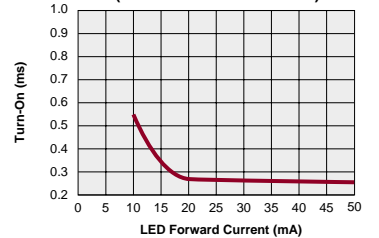

LCC120

PERFORMANCE DATA

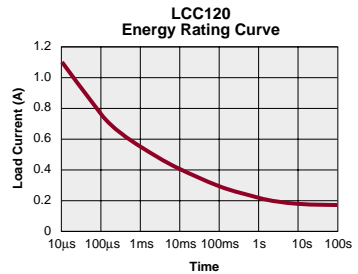
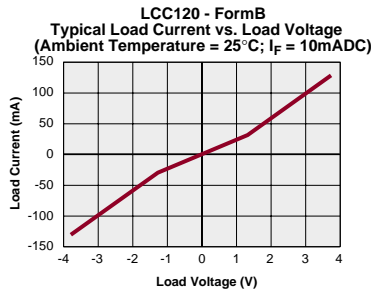
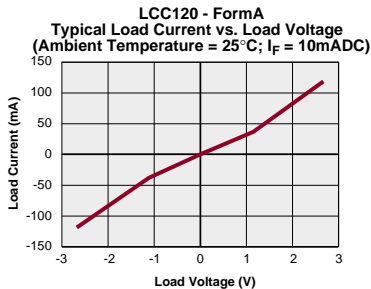
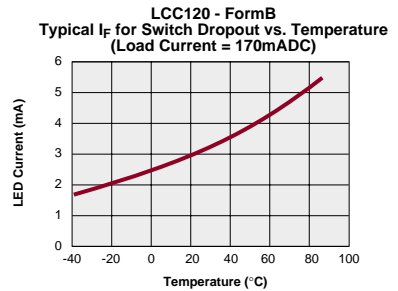
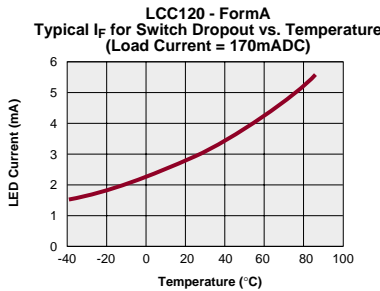
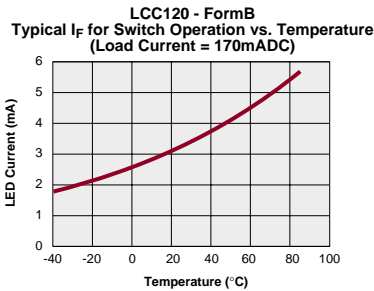
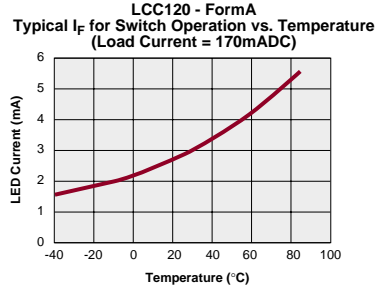
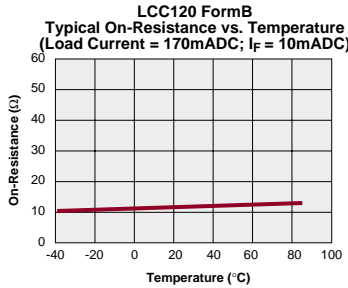
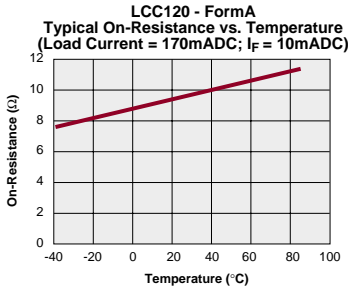
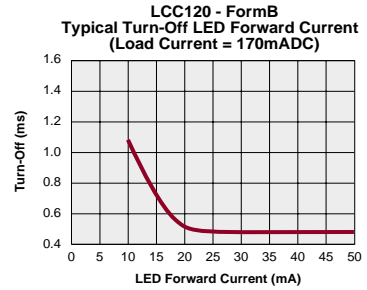
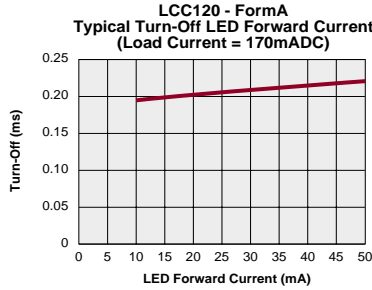
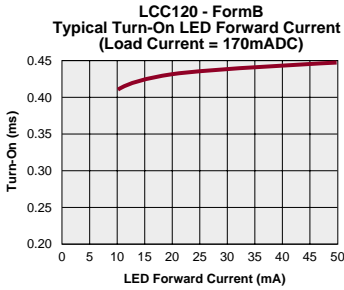



DESCRIPTION

The OAA160 is a 250V, 50mA, 100Ω type 2-Form-A solid state relay.

FEATURES

- Small 8 Pin DIP Package
- Low Drive Power Requirements (TTL/CMOS Compatible)
- No Moving Parts
- High Reliability
- Arc-Free With No Snubbing Circuits
- 3750V_{RMS} Input/Output Isolation
- FCC Compatible
- VDE Compatible
- No EMI/RFI Generation
- Machine Insertable, Wave Solderable
- Current Limiting, Surface Mount and Tape & Reel Versions Available

APPROVALS

- UL Recognized: File Number E76270
- CSA Certified: File Number LR 43639-10
- BSI Certified:
 - BS EN 60950:1992 (BS7002:1992) Certificate #:7344
 - BS EN 41003:1993 Certificate #:7344

OPTIONS / SUFFIXES

- P: Flatpack Package
- S: Surface Mount Package
- TR: Tape & Reel

Switching Characteristics of Normally Open (Form A) Devices

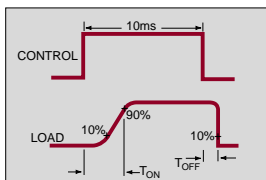

APPLICATIONS

- Telecommunications
 - Telecom Switching
 - Tip/Ring Circuits
 - Modem Switching (Laptop, Notebook, Pocket Size)
 - Hookswitch
 - Dial Pulsing
 - Ground Start
 - Ringer Injection
- Instrumentation
 - Multiplexers
 - Data Acquisition
 - Electronic Switching
 - I/O Subsystems
 - Meters (Watt-Hour, Water, Gas)
- Medical Equipment-Patient/Equipment Isolation
- Security
- Aerospace
- Industrial Controls

RATINGS (@ 25° C)

Parameter	Min	Typ	Max	Units
Input Power Dissipation	-	-	150 ¹	mW
Input Control Current	-	-	50	mA
Peak (10ms)	-	-	1	A
Reverse Input Voltage	-	-	5	V
Total Power Dissipation	-	-	800 ²	mW
Capacitance				
Input to Output	-	3	-	pF
Isolation Voltage				
Input to Output	3750	-	-	V _{RMS}
Operational Temperature	-40	-	+85	°C
Storage Temperature	-40	-	+125	°C
Soldering Temperature (10 Seconds Max.)				
DIP Package	-	-	+260	°C
Flatpack/Surface Mount Pkg	-	-	+220	°C

¹ Derate Linearly 1.33 mw/°C
² Derate Linearly 1.67 mw/°C

Note: For Mechanical Dimensions See Pages 396-401

www.cpcclare.com

SPECIFICATIONS

PARAMETERS	CONDITIONS	SYMBOL	MIN	TYP	MAX	UNITS
Output Characteristics @ 25°C						
Load Voltage (Peak)	-	V_L	-	-	250	V
Load Current* (Continuous) AC/DC Configuration	-	I_L	-	-	50	mA
Peak Load Current	10ms	I_{LPK}	-	-	100	mA
On-Resistance AC/DC Configuration	$I_L=50mA$	R_{ON}	-	50	100	Ω
Off-State Leakage Current	$V_L=250V$	I_{LEAK}	-	-	0.025	μA
Switching Speeds						
Turn-On	$I_F=10mA, V_L=10V$	T_{ON}	-	-	0.125	ms
Turn-Off	$I_F=10mA, V_L=10V$	T_{OFF}	-	-	0.125	ms
Output Capacitance	50V; f=1MHz	C_{OUT}	-	5	-	pF
Input Characteristics @ 25°C						
Input Control Current	$I_L=50mA$	I_F	10	-	50	mA
Input Dropout Current	-	I_F	0.4	0.7	-	mA
Input Voltage Drop	$I_F=10mA$	V_F	0.9	1.2	1.4	V
Reverse Input Voltage	-	V_R	-	-	5	V
Reverse Input Current	$V_R=5V$	I_R	-	-	10	μA
Input to Output Capacitance	-	$C_{I/O}$	-	3	-	pF
Input to Output Isolation	-	$V_{I/O}$	3750	-	-	V_{RMS}

*NOTE: If both poles operate simultaneously load current must be derated so as not to exceed the package power dissipation value.

OAA160 Pinout

AC/DC Configuration

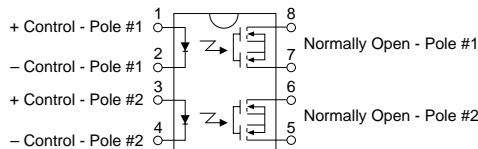

Note: For Mechanical Dimensions See Pages 396-401

PERFORMANCE DATA

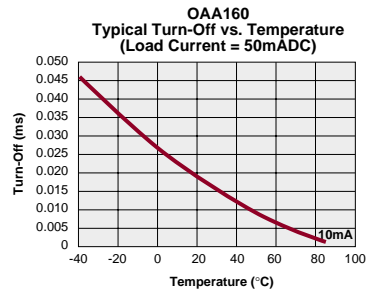
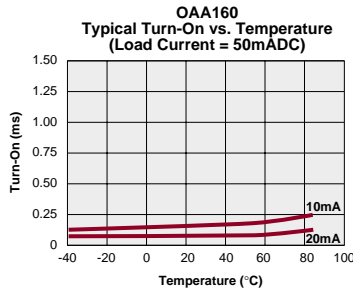
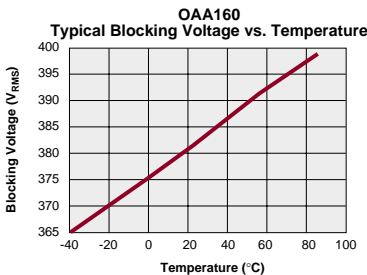
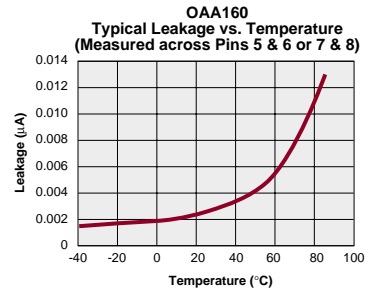
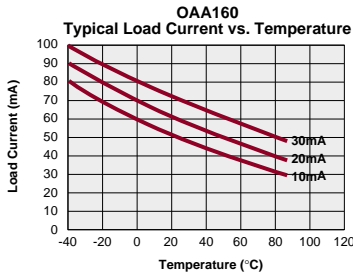
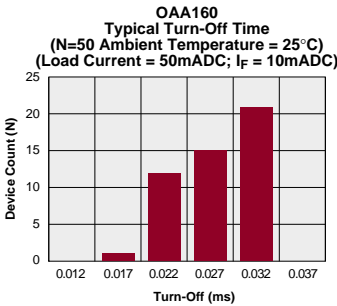
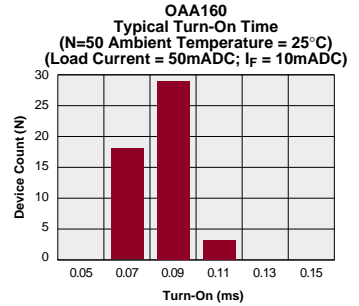
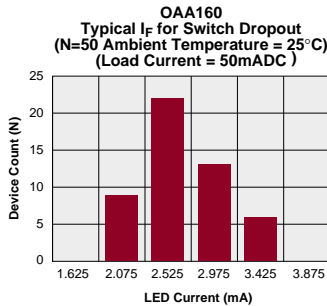
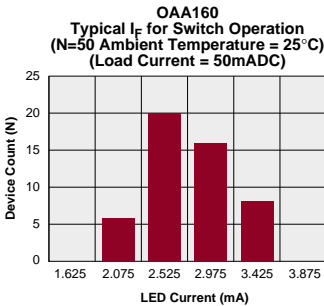
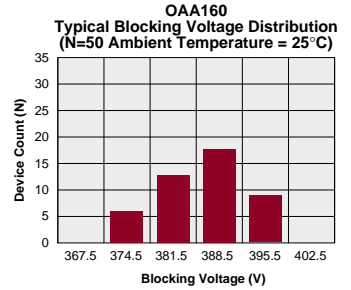
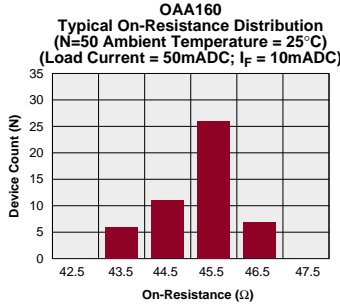
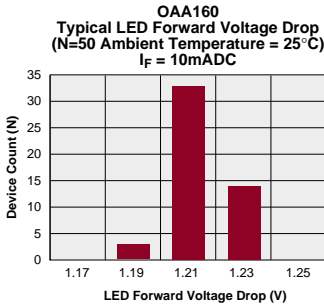

OAA160

PERFORMANCE DATA

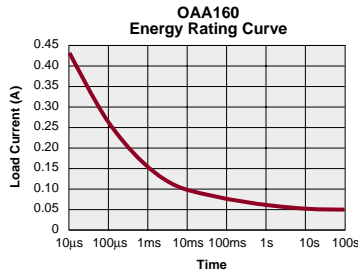
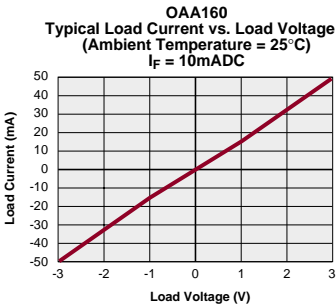
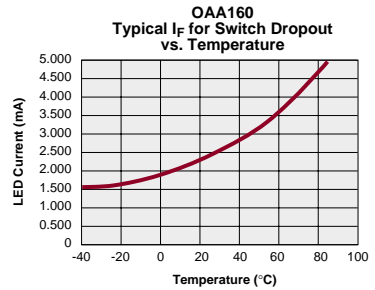
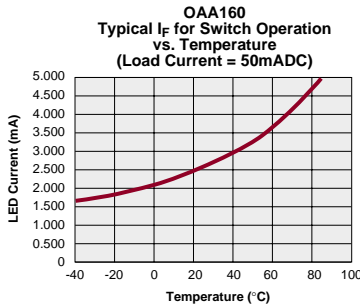
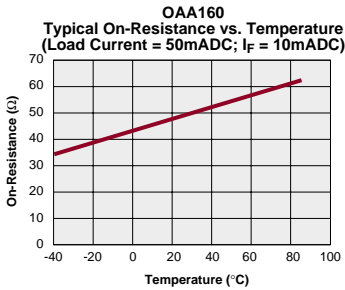
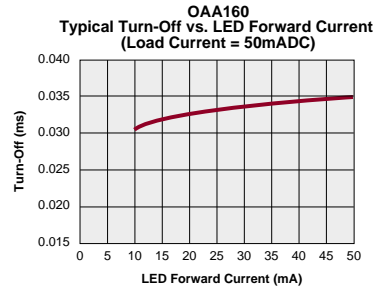
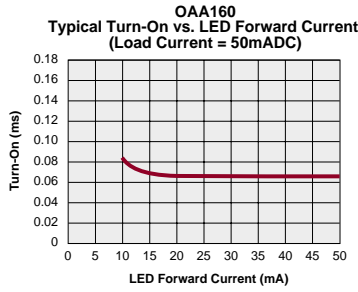
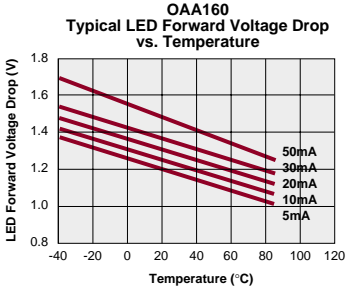



DESCRIPTION

The PAA110 is a 400V, 150mA, 22Ω type 2-Form-A solid state relay. Current limiting version available ("L" suffix).

FEATURES

- Small 8 Pin DIP Package
- Low Drive Power Requirements (TTL/CMOS Compatible)
- No Moving Parts
- High Reliability
- Arc-Free With No Snubbing Circuits
- 3750V_{RMS} Input/Output Isolation
- VDE Compatible
- FCC Compatible
- No EMI/RFI Generation
- Machine Insertable, Wave Solderable
- Current Limiting, Surface Mount and Tape & Reel Versions Available

APPROVALS

- UL Recognized: File Number E76270
- CSA Certified: File Number LR 43639-10
- BSI Certified:
 - BS EN 60950:1992 (BS7002:1992) Certificate #:7344
 - BS EN 41003:1993 Certificate #:7344

OPTIONS / SUFFIXES

- P: Flatpack Package
- L: Current Limiting
- S: Surface Mount Package
- TR: Tape & Reel

Switching Characteristics of Normally Open (Form A) Devices

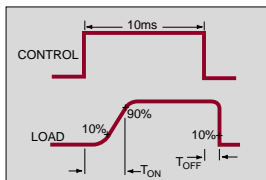

APPLICATIONS

- Telecommunications
 - Telecom Switching
 - Tip/Ring Circuits
 - Modem Switching (Laptop, Notebook, Pocket Size)
 - Hookswitch
 - Dial Pulsing
 - Ground Start
 - Ringer Injection
- Instrumentation
 - Multiplexers
 - Data Acquisition
 - Electronic Switching
 - I/O Subsystems
 - Meters (Watt-Hour, Water, Gas)
- Medical Equipment-Patient/Equipment Isolation
- Security
- Aerospace
- Industrial Controls

RATINGS (@ 25° C)

Parameter	Min	Typ	Max	Units
Input Power Dissipation	-	-	150 ¹	mW
Input Control Current	-	-	50	mA
Peak (10ms)	-	-	1	A
Reverse Input Voltage	-	-	5	V
Total Power Dissipation	-	-	800 ²	mW
Capacitance				
Input to Output	-	3	-	pF
Isolation Voltage				
Input to Output	3750	-	-	V _{RMS}
Operational Temperature	-40	-	+85	°C
Storage Temperature	-40	-	+125	°C
Soldering Temperature (10 Seconds Max.)	-	-	-	-
DIP Package	-	-	+260	°C
Flatpack/Surface Mount Pkg	-	-	+220	°C

¹ Derate Linearly 1.33 mw/°C

² Derate Linearly 1.67 mw/°C

Note: For Mechanical Dimensions See Pages 396-401

SPECIFICATIONS

PARAMETERS	CONDITIONS	SYMBOL	PAA110			PAA110L			UNITS
			MIN	TYP	MAX	MIN	TYP	MAX	
Output Characteristics @ 25°C									
Load Voltage (Peak)	-	V_L	-	-	400	-	-	400	V
Load Current* (Continuous)	-	I_L	-	-	150	-	-	150	mA
AC/DC Configuration	-	I_L	-	-	150	-	-	150	mA
Peak Load Current	10ms	I_{LPK}	-	-	400	-	-	-	mA
On-Resistance	-	R_{ON}	-	15	22	-	18	25	Ω
AC/DC Configuration	$I_L=150mA$	R_{ON}	-	15	22	-	18	25	Ω
Off-State Leakage Current	$V_L=400V$	I_{LEAK}	-	-	1	-	-	1	μA
Switching Speeds	-	T_{ON}	-	-	1	-	-	1	ms
Turn-On	$I_F=5mA, V_L=10V$	T_{ON}	-	-	1	-	-	1	ms
Turn-Off	$I_F=5mA, V_L=10V$	T_{OFF}	-	-	0.25	-	-	0.25	ms
Output Capacitance	50V; f=1MHz	C_{OUT}	-	25	-	-	25	-	pF
Load Current Limiting	-	I_{CL}	-	-	-	190	235	280	mA
Input Characteristics @ 25°C									
Input Control Current	$I_L=150mA$	I_F	5	-	50	5	-	50	mA
Input Dropout Current	-	I_F	0.4	0.7	-	0.4	0.7	-	mA
Input Voltage Drop	$I_F=5mA$	V_F	0.9	1.2	1.4	0.9	1.2	1.4	V
Reverse Input Voltage	-	V_R	-	-	5	-	-	5	V
Reverse Input Current	$V_R=5V$	I_R	-	-	10	-	-	10	μA
Input to Output Capacitance	-	$C_{I/O}$	-	3	-	-	3	-	pF
Input to Output Isolation	-	$V_{I/O}$	3750	-	-	3750	-	-	V_{RMS}

*NOTE: If both poles operate simultaneously load current must be derated so as not to exceed the package power dissipation value.

PAA110 Pinout

AC/DC Configuration

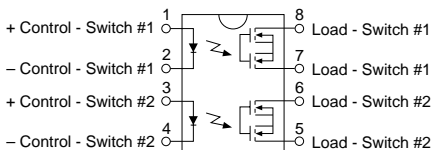

PAA110L Pinout

AC/DC Configuration

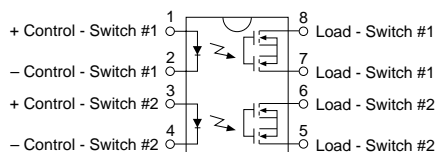

Note: For Mechanical Dimensions See Pages 396-401

PERFORMANCE DATA

PAA110
Typical LED Forward Voltage Drop
(N=50 Ambient Temperature = 25°C)
I_F = 5mAADC

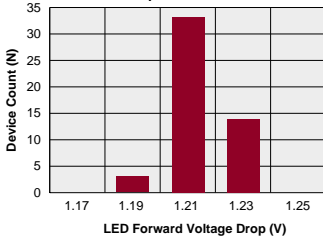

PAA110
Typical On-Resistance Distribution
(N=50 Ambient Temperature = 25°C)
(Load Current = 150mAADC; I_F = 5mAADC)

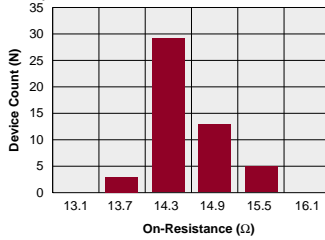

PAA110
Typical Blocking Voltage Distribution
(N=50 Ambient Temperature = 25°C)

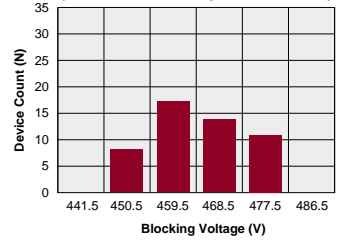

PAA110
Typical I_F for Switch Operation
(N=50 Ambient Temperature = 25°C)
(Load Current = 150mAADC)

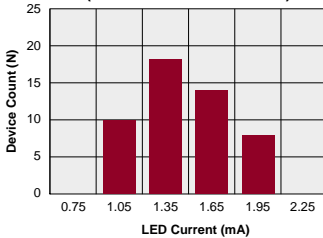

PAA110
Typical I_F for Switch Drop-out
(N=50 Ambient Temperature = 25°C)

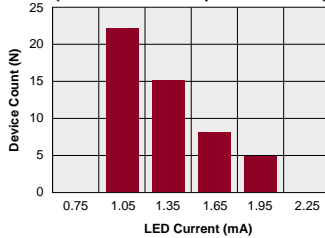

PAA110
Typical Turn-On Time
(N=50 Ambient Temperature = 25°C)
(Load Current = 150mAADC; I_F = 5mAADC)

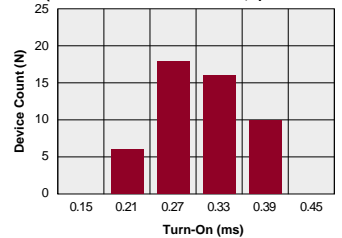

PAA110
Typical Turn-Off Time
(N=50 Ambient Temperature = 25°C)
(Load Current = 150mAADC; I_F = 5mAADC)

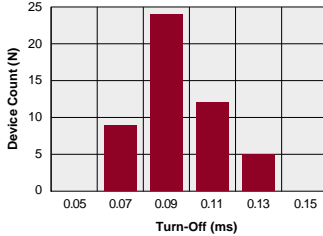

PAA110
Typical Load Current vs. Temperature

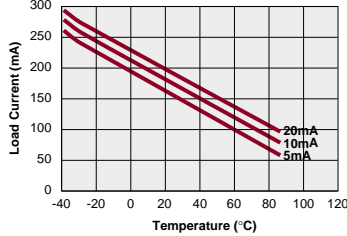

PAA110
Typical Leakage vs. Temperature
(Measured across Pins 4 & 6)

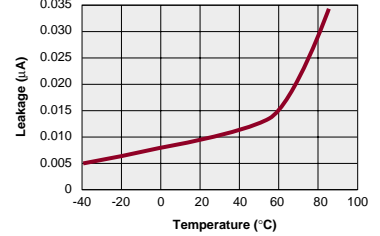

PAA110
Typical Blocking Voltage vs. Temperature

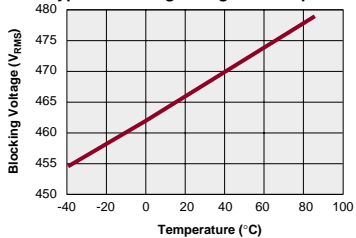

PAA110
Typical Turn-On vs. Temperature
(Load Current = 150mAADC)

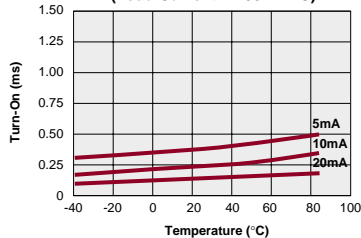

PAA110
Typical Turn-Off vs. Temperature
(Load Current = 150mAADC)

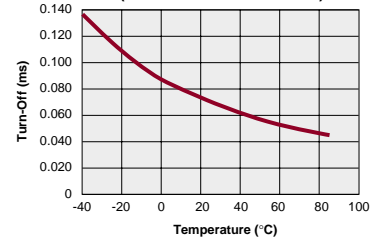

PERFORMANCE DATA

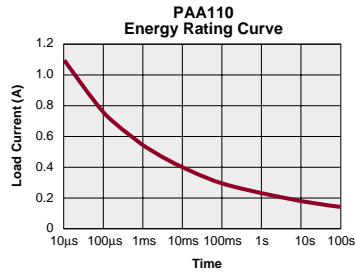
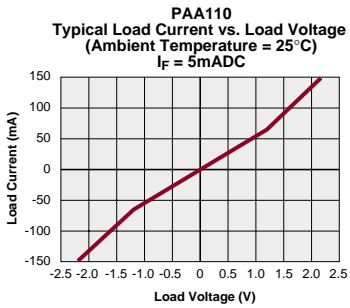
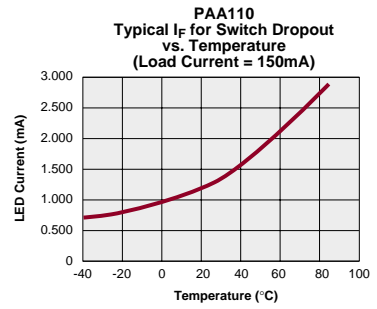
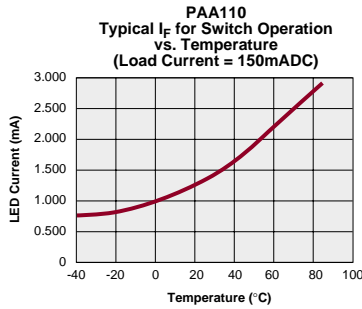
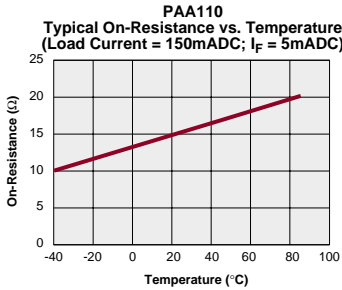
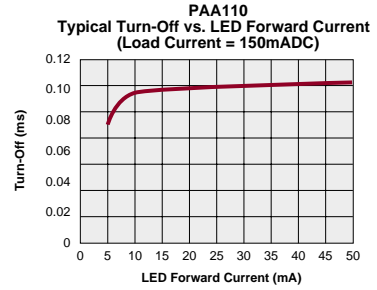
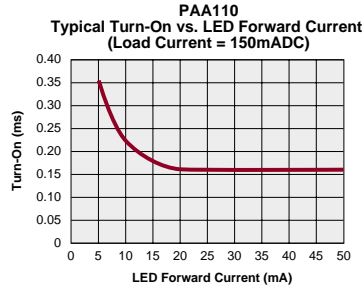
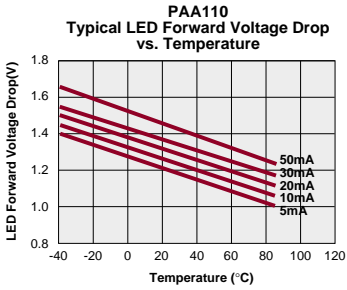

PERFORMANCE DATA

PAA110L
Typical LED Forward Voltage Drop
(N=50 Ambient Temperature = 25°C)
I_F = 5mA

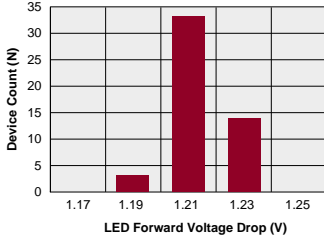

PAA110L
Typical On-Resistance Distribution
(N=50 Ambient Temperature = 25°C)
(Load Current = 150mA; I_F = 5mA)

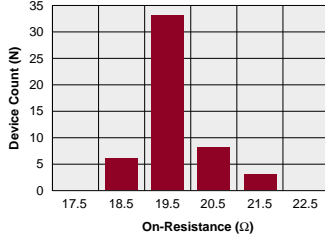

PAA110L
Typical Blocking Voltage Distribution
(N=50 Ambient Temperature = 25°C)

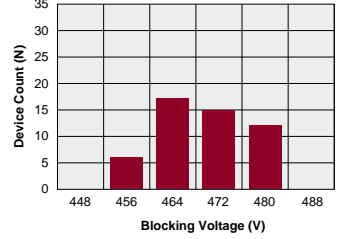

PAA110L
Typical I_F for Switch Operation
(N=50 Ambient Temperature = 25°C)
(Load Current = 150mA)

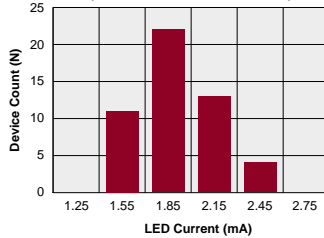

PAA110L
Typical I_F for Switch Dropout
(N=50 Ambient Temperature = 25°C)

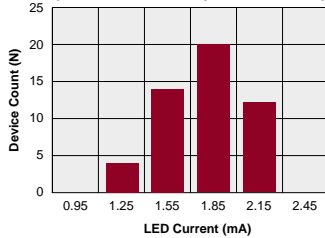

PAA110L
Typical Turn-On Time
(N=50 Ambient Temperature = 25°C)
(Load Current = 150mA; I_F = 5mA)

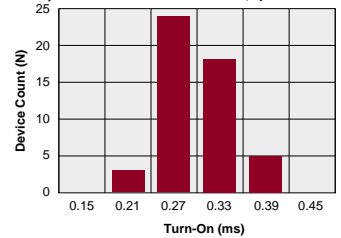

PAA110L
Typical Turn-Off Time
(N=50 Ambient Temperature = 25°C)
(Load Current = 150mA; I_F = 5mA)

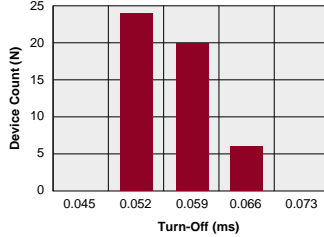

PAA110L
Typical Load Current vs. Temperature

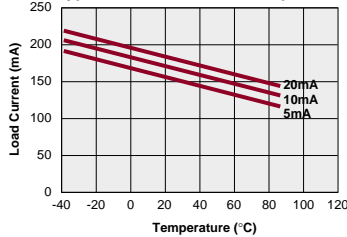

PAA110L
Typical Leakage vs. Temperature
(Measured across Pins 5 & 6 or 7 & 8)

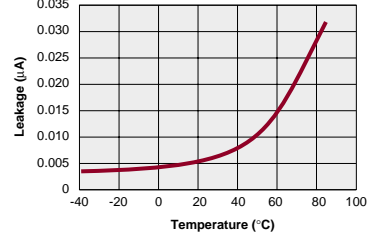

PAA110L
Typical Blocking Voltage vs. Temperature

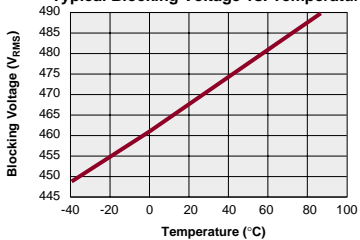

PAA110L
Typical Turn-On vs. Temperature
(Load Current = 150mA)

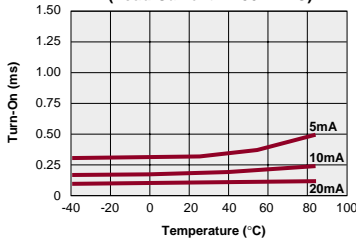

PAA110L
Typical Turn-Off vs. Temperature
(Load Current = 150mA)

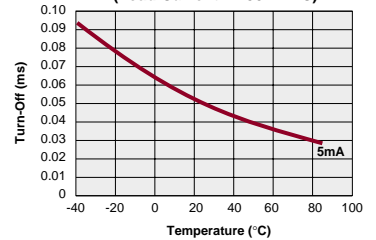

PAA110/PAA110L

PERFORMANCE DATA

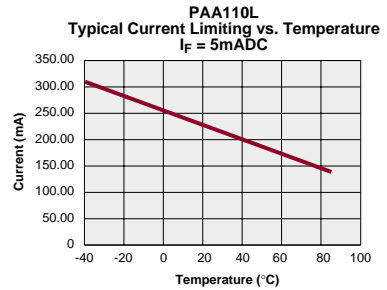
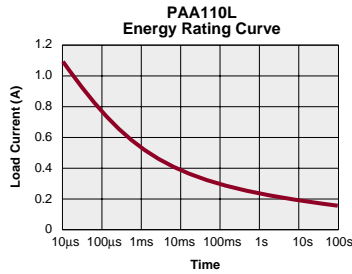
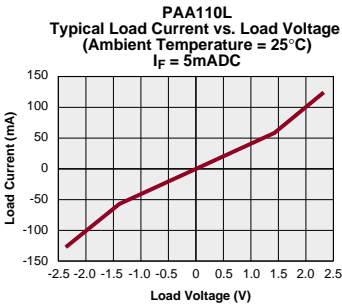
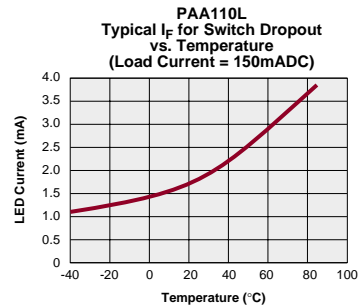
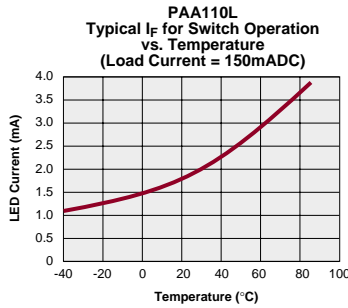
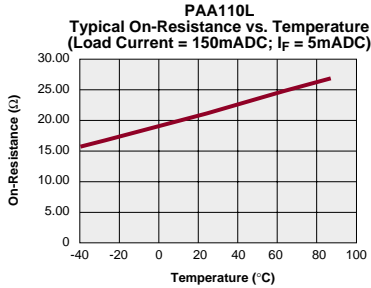
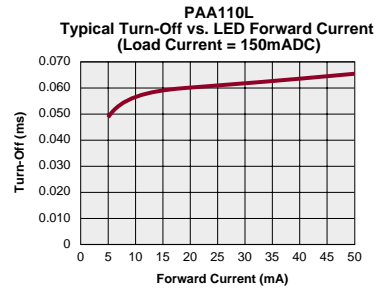
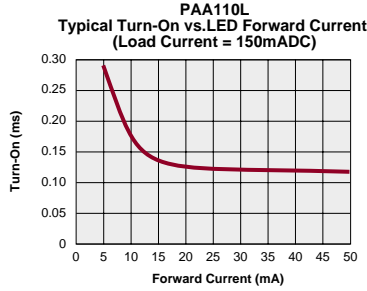
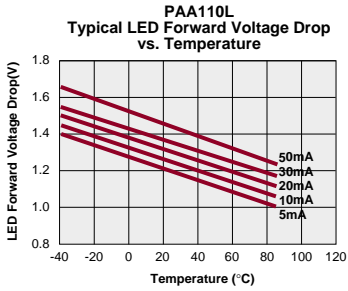



DESCRIPTION

The PAA140 is a 400V, 250mA, 8Ω type 2-Form-A solid state relay.

FEATURES

- Small 8 Pin DIP Package
- Low Drive Power Requirements (TTL/CMOS Compatible)
- No Moving Parts
- High Reliability
- Arc-Free With No Snubbing Circuits
- 3750V_{RMS} Input/Output Isolation
- FCC Compatible
- VDE Compatible
- No EMI/RFI Generation
- Machine Insertable, Wave Solderable
- Current Limiting, Surface Mount and Tape & Reel Versions Available

APPROVALS

- UL Recognized: File Number E76270
- CSA Certified: File Number LR 43639-10
- BSI Certified:
 - BS EN 60950:1992 (BS7002:1992) Certificate #:7344
 - BS EN 41003:1993 Certificate #:7344

OPTIONS / SUFFIXES

- P: Flatpack Package
- S: Surface Mount Package
- TR: Tape & Reel

Switching Characteristics of Normally Open (Form A) Devices

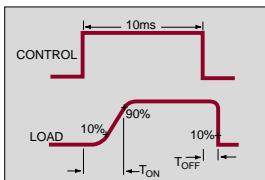

APPLICATIONS

- Telecommunications
 - Telecom Switching
 - Tip/Ring Circuits
 - Modem Switching (Laptop, Notebook, Pocket Size)
 - Hookswitch
 - Dial Pulsing
 - Ground Start
 - Ringer Injection
- Instrumentation
 - Multiplexers
 - Data Acquisition
 - Electronic Switching
 - I/O Subsystems
 - Meters (Watt-Hour, Water, Gas)
- Medical Equipment-Patient/Equipment Isolation
- Security
- Aerospace
- Industrial Controls

RATINGS (@ 25° C)

Parameter	Min	Typ	Max	Units
Input Power Dissipation	-	-	150 ¹	mW
Input Control Current	-	-	50	mA
Peak (10ms)	-	-	1	A
Reverse Input Voltage	-	-	5	V
Total Power Dissipation	-	-	800 ²	mW
Capacitance				
Input to Output	-	3	-	pF
Isolation Voltage				
Input to Output	3750	-	-	V _{RMS}
Operational Temperature	-40	-	+85	°C
Storage Temperature	-40	-	+125	°C
Soldering Temperature	-	-	-	-
(10 Seconds Max.)				
DIP Package	-	-	+260	°C
Flatpack/Surface Mount Pkg	-	-	+220	°C

¹ Derate Linearly 1.33 mw/°C
² Derate Linearly 1.67 mw/°C

Note: For Mechanical Dimensions See Pages 396-401

www.cpclare.com

SPECIFICATIONS

PARAMETERS	CONDITIONS	SYMBOL	MIN	TYP	MAX	UNITS
Output Characteristics @ 25°C						
Load Voltage (Peak)	-	V_L	-	-	400	V
Load Current* (Continuous) AC/DC Configuration	-	I_L	-	-	250	mA
Peak Load Current	10ms	I_{LPK}	-	-	500	mA
On-Resistance AC/DC Configuration	$I_L=250\text{mA}$	R_{ON}	-	6	8	Ω
Off-State Leakage Current	$V_L=400\text{V}$	I_{LEAK}	-	-	1	μA
Switching Speeds						
Turn-On	$I_F=5\text{mA}, V_L=10\text{V}$	T_{ON}	-	-	1.5	ms
Turn-Off	$I_F=5\text{mA}, V_L=10\text{V}$	T_{OFF}	-	-	0.25	ms
Output Capacitance	50V; f=1MHz	C_{OUT}	-	65	-	pF
Input Characteristics @ 25°C						
Input Control Current	$I_L=250\text{mA}$	I_F	5	-	50	mA
Input Dropout Current	-	I_F	0.4	0.7	-	mA
Input Voltage Drop	$I_F=5\text{mA}$	V_F	0.9	1.2	1.4	V
Reverse Input Voltage	-	V_R	-	-	5	V
Reverse Input Current	$V_R=5\text{V}$	I_R	-	-	10	μA
Input to Output Capacitance	-	$C_{I/O}$	-	3	-	pF
Input to Output Isolation	-	$V_{I/O}$	3750	-	-	V_{RMS}

*NOTE: If both poles operate simultaneously load current must be derated so as not to exceed the package power dissipation value.

PAA140 Pinout

AC/DC Configuration

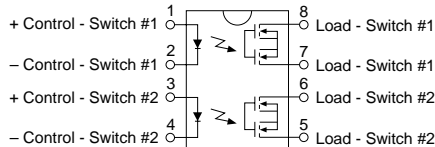

Note: For Mechanical Dimensions See Pages 396-401

PERFORMANCE DATA

PAA140
Typical LED Forward Voltage Drop
(N=50 Ambient Temperature = 25°C; I_F = 5mADC)

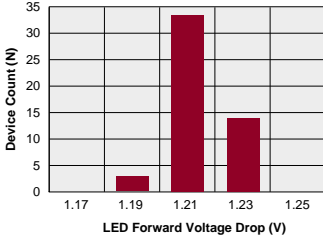

PAA140
Typical On-Resistance Distribution
(N=50 Ambient Temperature = 25°C)
(Load Current = 250mADC, I_F = 5mADC)

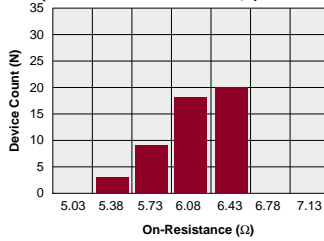

PAA140
Typical Blocking Voltage Distribution
(N=50 Ambient Temperature = 25°C)

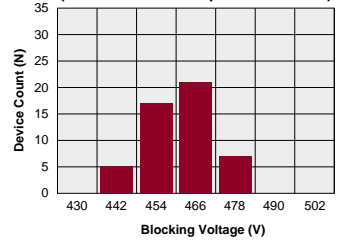

PAA140
Typical I_F for Switch Operation
(N=50 Ambient Temperature = 25°C)
(Load Current = 250mADC)

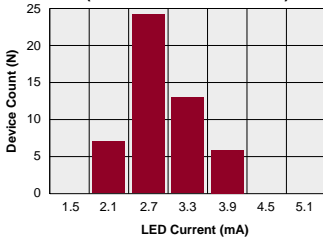

PAA140
Typical I_F for Switch Dropout
(N=50 Ambient Temperature = 25°C)
(Load Current = 250mADC)

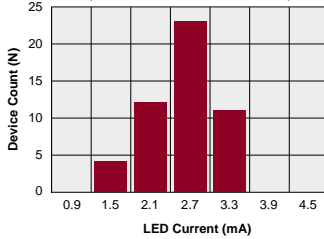

PAA140
Typical Turn-On Time
(N=50 Ambient Temperature = 25°C)
(Load Current = 250mADC; I_F = 5mADC)

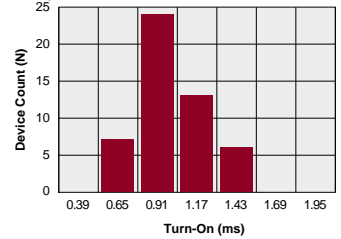

PAA140
Typical Turn-Off Time
(N=50 Ambient Temperature = 25°C)
(Load Current = 250mADC; I_F = 5mADC)

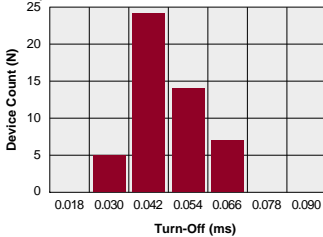

PAA140
Typical Load Current vs. Temperature

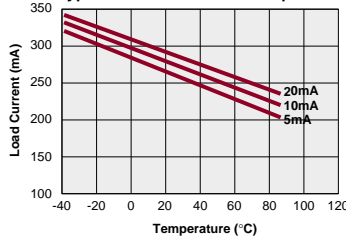

PAA140
Typical Leakage vs. Temperature
(Measured across Pins 5 & 6 or 7 & 8)

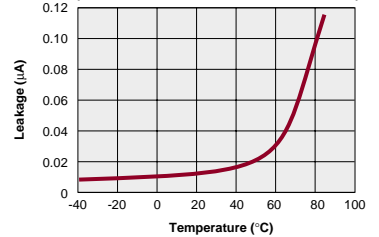

PAA140
Typical Blocking Voltage vs. Temperature

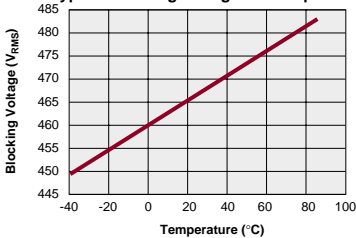

PAA140
Typical Turn-On vs. Temperature
(Load Current = 250mADC)

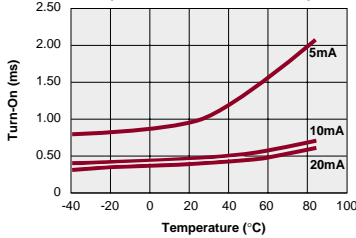

PAA140
Typical Turn-Off vs. Temperature
(Load Current = 250mADC)

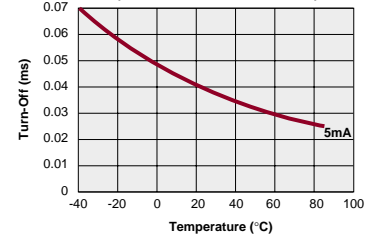

PAA140

PERFORMANCE DATA

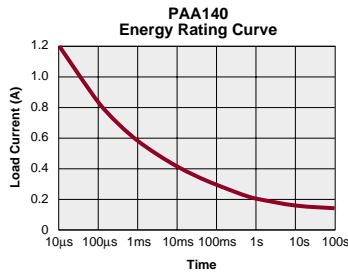
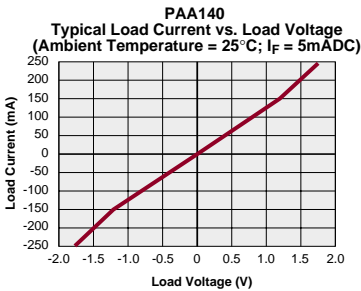
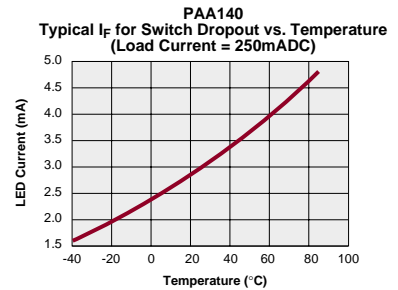
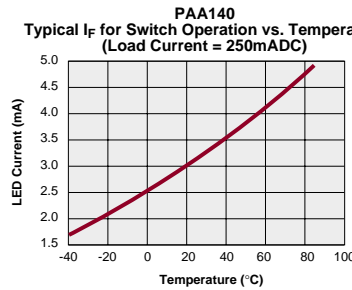
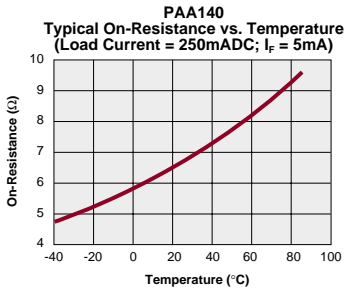
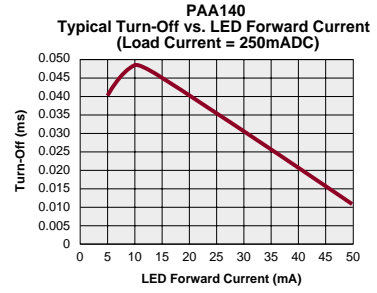
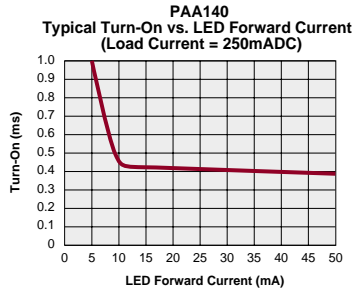
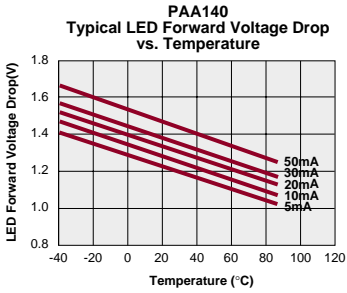

Multifunction Telecom Switches



CP Clare's Multifunction Telecom Switches (TS series) mark Clare's evolution from "switching" devices to "integrated" devices in order to further serve the telecom industry. By providing an optically isolated solid state relay in the same eight pin package as an optocoupler, CP Clare has given designers a way to consolidate circuits and save both board space and money. The TS can replace typical components found in telecom circuits while being utilized for functions as hookswitch (relay) and ring signal detection (optocoupler). Because the hookswitch has very low power consumption (2mA), it can often be powered from a modem micro processor or data pump. In addition, it is polarity insensitive and can be operated with tip and ring reversed. The TS is available in the through hole, surface mount and Flatpack package. Current limiting is optional for the relay portion on certain models.

Multifunction Telecom Switches

Part Number	TS112	TS117	XS170	TS118	TS120	TS122	TS190	Units
Package Type	8 Pin DIP	8 Pin DIP	8 Pin DIP	8 Pin DIP	8 Pin DIP	8 Pin DIP	8 Pin DIP	-
Contact Form	1-Form-A	1-Form-A	1-Form-A	1-Form-B	1-Form-A	1-Form-A	1-Form-A	-
<i>Relay Portion</i>								
Load Voltage (Peak)	350	350	350	350	350	250	400	V
Load Current (Continuous)	120	120	100	120	120	170	150	mA
On-Resistance @ Rated Load Current	20	35	50	35	35	20	22	Ω
Input Control Current (Iled)	2	2	2	5	5	5	5	mA
<i>Detector Portion</i>								
Current Transfer Ratio (Typ)	100	100	100	100	1000	100	100	%

ORDERING INFORMATION

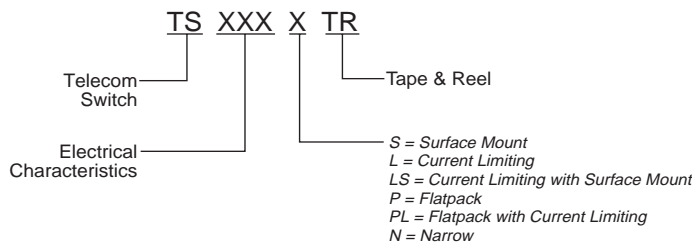

TS112



FEATURES

- Small 8 Pin SOIC Narrow Package
- Low Drive Power Requirements (TTL/CMOS Compatible)
- No Moving Parts
- High Reliability
- Arc-Free With No Snubbing Circuits
- 1500V_{RMS} Input/Output Isolation
- FCC Compatible
- VDE Compatible
- No EMI/RFI Generation
- Machine Insertable, Wave Solderable
- Tape & Reel Version Available

APPROVALS

- UL Recognized: File Number Pending
- CSA Certified: File Number Pending
- BSI Certified: Pending

OPTIONS / SUFFIXES

- Narrow Package
- TR: Tape & Reel

TS112 Pinout

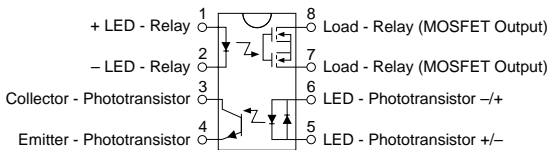

DESCRIPTION

The TS112 is a 350V, 120mA, 20Ω type 1-Form-A solid state relay for hookswitch combined with an optocoupler for detection of loop current or ringing signal in a single 8 pin SOIC Narrow package.

APPLICATIONS

- Telecommunications
 - Telecom Switching
 - Tip/Ring Circuits
 - Modem Switching (Laptop, Notebook, Pocket Size)
 - Hookswitch
 - Dial Pulsing
 - Ground Start
 - Ringer Injection
- Instrumentation
 - Multiplexers
 - Data Acquisition
 - Electronic Switching
 - I/O Subsystems
 - Meters (Watt-Hour, Water, Gas)
- Medical Equipment-Patient/Equipment Isolation
- Security
- Aerospace
- Industrial Controls

RATINGS (@ 25° C)

Parameter	Min	Typ	Max	Units
Input Power Dissipation	-	-	150 ¹	mW
Input Control Current	-	-	100	mA
Peak (10ms)	-	-	1	A
Reverse Input Voltage	-	-	5	V
Total Power Dissipation	-	-	800 ²	mW
Capacitance				
Input to Output	-	3	-	pF
Isolation Voltage				
Input to Output	1500	-	-	V _{RMS}
Operational Temperature	-40	-	+85	°C
Storage Temperature	-40	-	+125	°C
Soldering Temperature (10 Seconds Max.)			+220	°C

¹ Derate Linearly 1.33 mw/°C
² Derate Linearly 1.67 mw/°C

Note: For Mechanical Dimensions See Pages 396-401

SPECIFICATIONS

PARAMETERS	CONDITIONS	SYMBOL	MIN	TYP	MAX	MIN
Relay Portion (Pins 7, 8) Output Characteristics @ 25°C						
Load Voltage (Peak)	-	V_L	-	-	350	V
Load Current (Continuous)	-	I_L	-	-	120	mA
Peak Load Current	10ms	I_{LPK}	-	-	350	mA
On-Resistance	$I_L=120mA$	R_{ON}	-	15	20	Ω
Off-State Leakage Current	$V_L=350V$	I_{LEAK}	-	-	1	μA
Switching Speeds						
Turn-On	$I_F=5mA, V_L=10V$	T_{ON}	-	-	3	ms
Turn-Off	$I_F=5mA, V_L=10V$	T_{OFF}	-	-	3	ms
Output Capacitance	50V; $f=1MHz$	C_{OUT}	-	25	-	pF
Load Current Limit		I_{CL}	-	-	-	mA
Relay Portion (Pins 1, 2) Input Characteristics @ 25°C						
Input Control Current	$I_L=120mA$	I_F	2	-	50	mA
Input Dropout Current	-	I_F	0.4	0.7	-	mA
Input Voltage Drop	$I_F=5mA$	V_F	0.9	1.2	1.4	V
Reverse Input Voltage	-	V_R	-	-	5	V
Reverse Input Current	V_R	I_R	-	-	10	μA
Detector Portion (Pins 3, 4) Output Characteristics @ 25°C						
Phototransistor Blocking Voltage	$I_C=10\mu A$	BV_{CEO}	20	50	-	V
Phototransistor Output Current	$V_{CE}=5V, I_F=0mA$	I_{CEO}	-	50	500	nA
Saturation Voltage	$I_C=2mA, I_F=16mA$	V_{SAT}	-	0.3	0.5	V
Current Transfer Ratio	$I_F=6mA, V_{CE}=0.5V$	CTR	33	100	-	%
Detector Portion (Pins 5, 6) Input Characteristics @ 25°C						
Input Control Current	$I_C=2mA, V_{CE}=0.5V$	I_F	6	2	100	mA
Input Voltage Drop	$I_F=5mA$	V_F	0.9	1.2	1.4	V
Input Current (Detector must be off)	$I_C=1\mu A, V_{CE}=5V$	I_F	5	25	-	μA
Input to Output Capacitance (Relay Only)	-	$C_{I/O}$	-	0.8	-	pF
Input to Output Isolation	-	$V_{I/O}$	1500	-	-	V_{RMS}

Note: For Mechanical Dimensions See Pages 396-401

PERFORMANCE DATA

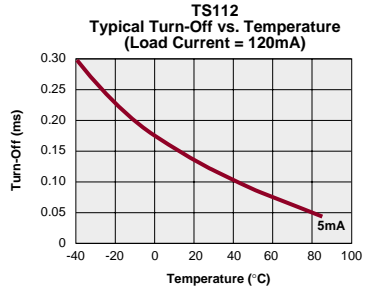
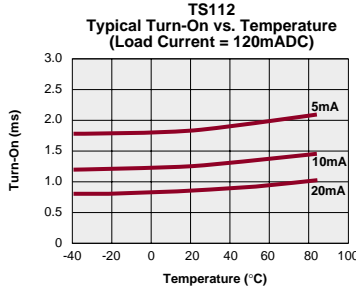
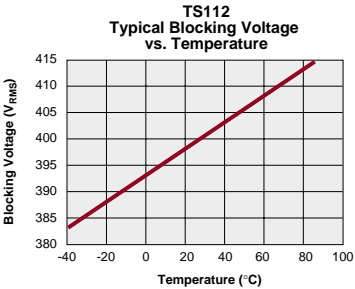
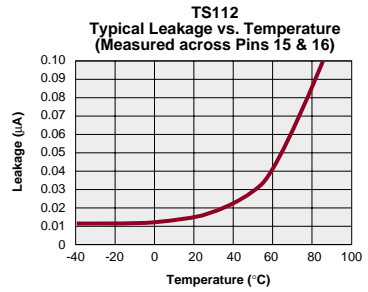
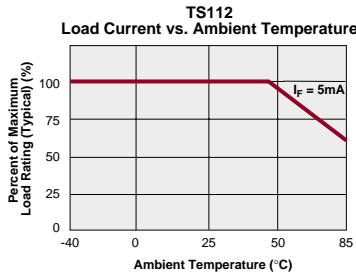
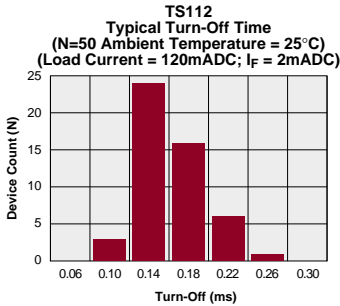
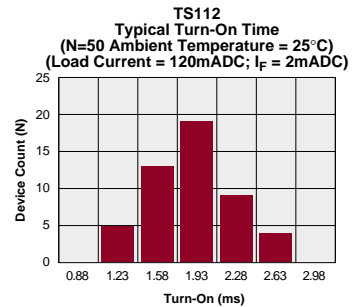
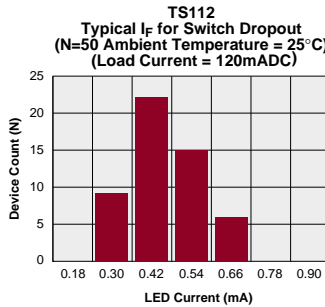
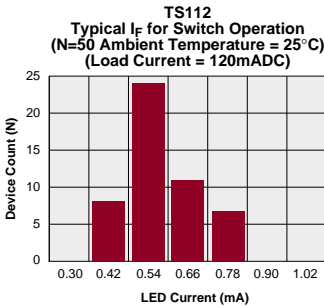
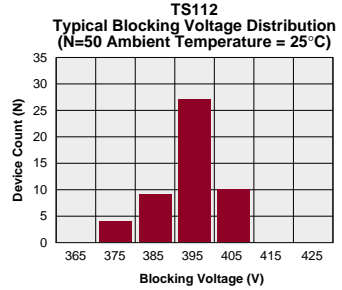
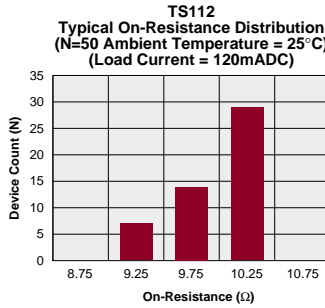
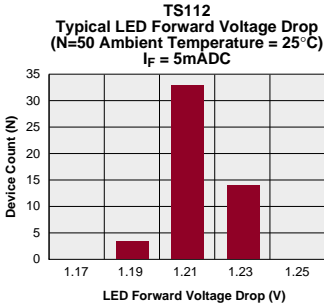

PERFORMANCE DATA

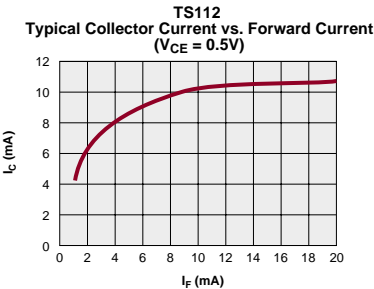
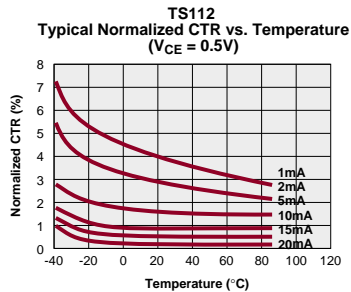
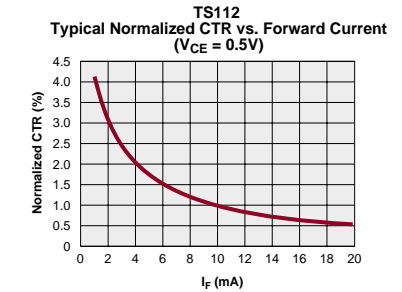
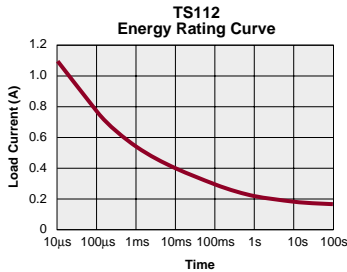
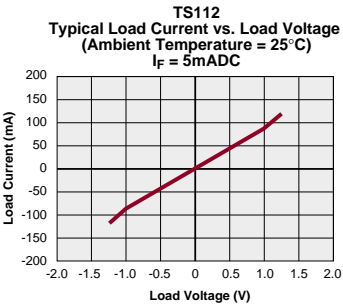
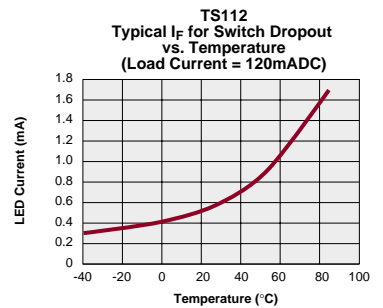
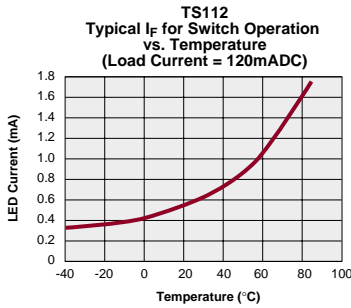
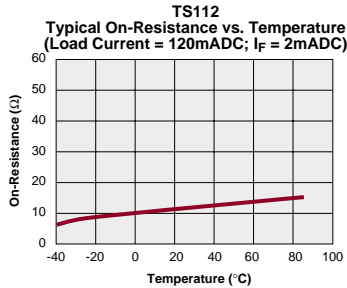
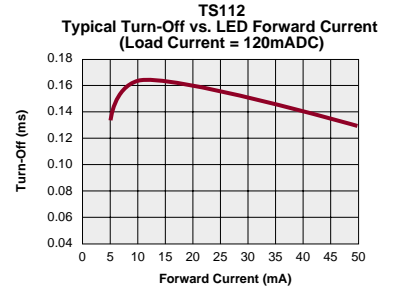
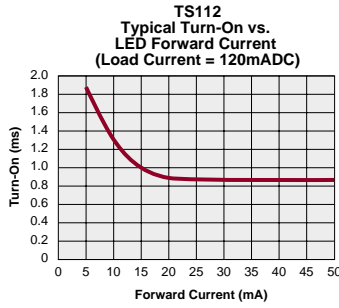
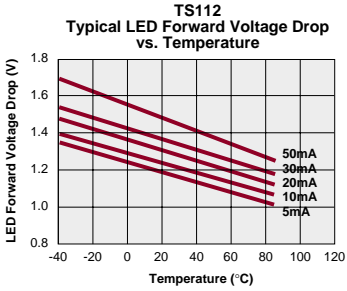

MULTIFUNCTION TELECOM SWITCH

TS117/TS117L

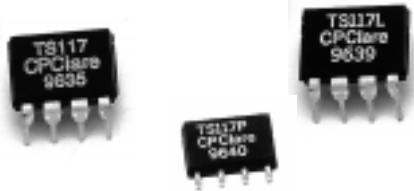

FEATURES

- Small 8 Pin DIP Package
- Low Drive Power Requirements (TTL/CMOS Compatible)
- No Moving Parts
- High Reliability
- Arc-Free With No Snubbing Circuits
- 3750V_{RMS} Input/Output Isolation
- FCC Compatible
- VDE Compatible
- No EMI/RFI Generation
- Machine Insertable, Wave Solderable
- Surface Mount and Tape & Reel Versions Available

APPROVALS

- UL Recognized: File Number E76270
- CSA Certified: File Number LR 43639-10
- BSI Certified:
 - BS EN 60950:1992 (BS7002:1992) Certificate #:7344
 - BS EN 41003:1993 Certificate #:7344

OPTIONS / SUFFIXES

- P: Flatpack Package
- L: Current Limiting
- S: Surface Mount Package
- TR: Tape & Reel

TS117/TS117L Pinout

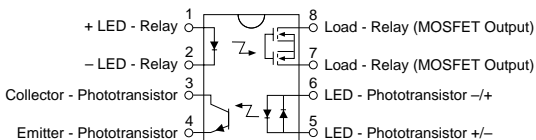

DESCRIPTION

The TS117 is a 350V, 120mA, 35Ω type 1-Form-A solid state relay for hookswitch combined with an optocoupler for detection of loop current or ringing signal in a single 8 pin DIP package. Current limiting version available. ("L" suffix).

APPLICATIONS

- Telecommunications
 - Telecom Switching
 - Tip/Ring Circuits
 - Modem Switching (Laptop, Notebook, Pocket Size)
 - Hookswitch
 - Dial Pulsing
 - Ground Start
 - Ringer Injection
- Instrumentation
 - Multiplexers
 - Data Acquisition
 - Electronic Switching
 - I/O Subsystems
 - Meters (Watt-Hour, Water, Gas)
- Medical Equipment-Patient/Equipment Isolation
- Security
- Aerospace
- Industrial Controls

RATINGS (@ 25°C)

Parameter	Min	Typ	Max	Units
Input Power Dissipation	-	-	150 ¹	mW
Input Control Current	-	-	100	mA
Peak (10ms)	-	-	1	A
Reverse Input Voltage	-	-	5	V
Total Power Dissipation	-	-	800 ²	mW
Capacitance				
Input to Output	-	3	-	pF
Isolation Voltage				
Input to Output	3750	-	-	V _{RMS}
Operational Temperature	-40	-	+85	°C
Storage Temperature	-40	-	+125	°C
Soldering Temperature (10 Seconds Max.)				
DIP Package	-	-	+260	°C
Flatpack/Surface Mount Package	-	-	+220	°C

¹ Derate Linearly 1.33 mw/°C

² Derate Linearly 1.67 mw/°C

Note: For Mechanical Dimensions See Pages 396-401

SPECIFICATIONS

PARAMETERS	CONDITIONS	SYMBOL	TS117			TS117L			UNITS
			MIN	TYP	MAX	MIN	TYP	MAX	
Relay Portion (Pins 7, 8) Output Characteristics @ 25°C									
Load Voltage (Peak)	-	V_L	-	-	350	-	-	350	V
Load Current (Continuous)	-	I_L	-	-	120	-	-	120	mA
Peak Load Current	10ms	I_{LPK}	-	-	350	-	-	-	mA
On-Resistance	$I_L=120mA$	R_{ON}	-	23	35	-	30	35	Ω
Off-State Leakage Current	$V_L=350V$	I_{LEAK}	-	-	1	-	-	1	μA
Switching Speeds									
Turn-On	$I_F=5mA, V_L=10V$	T_{ON}	-	-	3.0	-	-	3.0	ms
Turn-Off	$I_F=5mA, V_L=10V$	T_{OFF}	-	-	3.0	-	-	3.0	ms
Output Capacitance	50V; f=1MHz	C_{OUT}	-	25	-	-	25	-	pF
Load Current Limit		I_{CL}	-	-	-	130	170	210	mA
Relay Portion (Pins 1, 2) Input Characteristics @ 25°C									
Input Control Current	$I_L=120mA$	I_F	2	-	50	2	-	50	mA
Input Dropout Current	-	I_F	0.4	0.7	-	0.4	0.7	-	mA
Input Voltage Drop	$I_F=5mA$	V_F	0.9	1.2	1.4	0.9	1.2	1.4	V
Reverse Input Voltage	-	V_R	-	-	5	-	-	5	V
Reverse Input Current	$V_R=5V$	I_R	-	-	10	-	-	10	μA
Detector Portion (Pins 3,4) Output Characteristics @ 25°C									
Phototransistor Blocking Voltage	$I_C=10\mu A$	BV_{CEO}	20	50	-	20	50	-	V
Phototransistor Output Current	$V_{CE}=5V, I_F=0mA$	I_{CEO}	-	50	500	-	50	500	nA
Saturation Voltage	$I_C=2mA, I_F=16mA$	V_{SAT}	-	0.3	0.5	-	0.3	0.5	V
Current Transfer Ratio	$I_F=6mA, V_{CE}=0.5V$	CTR	33	100	-	33	100	-	%
Detector Portion (Pins 5,6) Input Characteristics @ 25°C									
Input Control Current	$I_C=2mA, V_{CE}=0.5V$	I_F	6	2	100	6	2	100	mA
Input Voltage Drop	$I_F=5mA$	V_F	0.9	1.2	1.4	0.9	1.2	1.4	V
Input Current (Detector must be off)	$I_C=1\mu A, V_{CE}=5V$	I_F	5	25	-	5	25	-	μA
Input to Output Capacitance (Relay Only)	-	$C_{I/O}$	-	3	-	-	3	-	pF
Input to Output Isolation	-	$V_{I/O}$	3750	-	-	3750	-	-	V_{RMS}

Note: For Mechanical Dimensions See Pages 396-401

PERFORMANCE DATA

TS117
Typical LED Forward Voltage Drop
(N=50 Ambient Temperature = 25°C; I_F = 5mA)

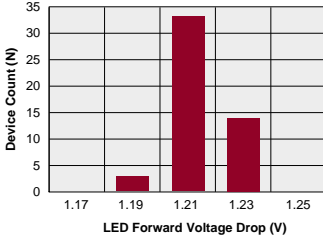

TS117
Typical On-Resistance Distribution
(N=50 Ambient Temperature = 25°C)
(Load: Voltage = 350VDC; Current = 120mA;
I_F = 2mA)

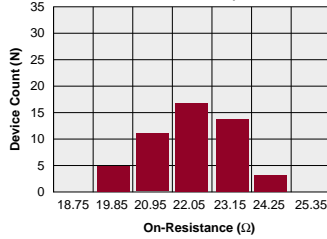

TS117
Typical Blocking Voltage Distribution
(N=50 Ambient Temperature = 25°C)

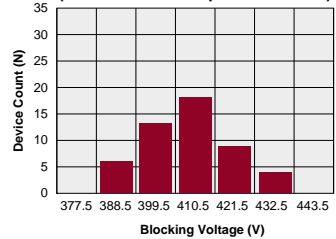

TS117
Typical I_F for Switch Operation
(N=50 Ambient Temperature = 25°C)
(Load Current = 120mA)

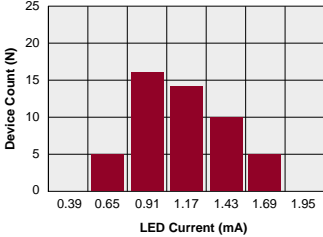

TS117
Typical I_F for Switch Dropout
(N=50 Ambient Temperature = 25°C)
(Load Current = 120mA)

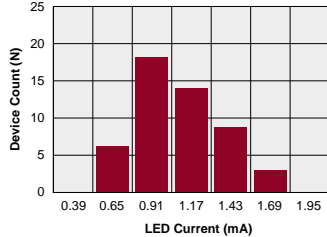

TS117
Typical Turn-On Time
(N=50 Ambient Temperature = 25°C)
(Load Current = 120mA; I_F = 2mA)

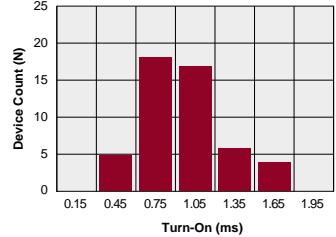

TS117
Typical Turn-Off Time
(N=50 Ambient Temperature = 25°C)
(Load Current = 120mA; I_F = 2mA)

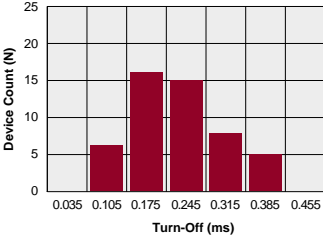

TS117
Typical Load Current vs. Temperature

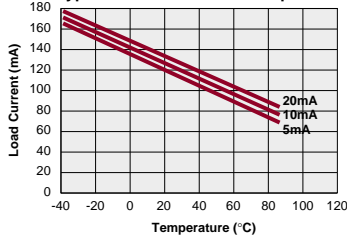

TS117
Typical Leakage vs. Temperature
(Measured across Pins 7 & 8)

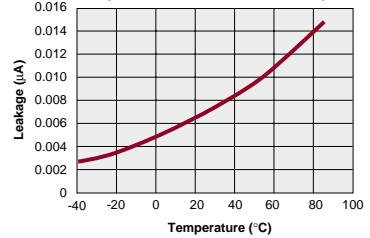

TS117
Typical Blocking Voltage vs. Temperature

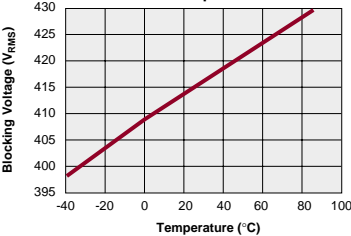

TS117
Typical Turn-On vs. Temperature
(Load Current = 120mA)

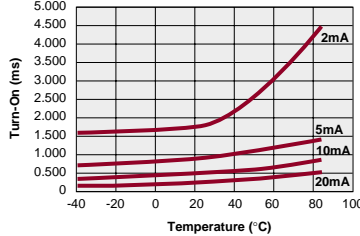

TS117
Typical Turn-Off vs. Temperature
(Load Current = 120mA)

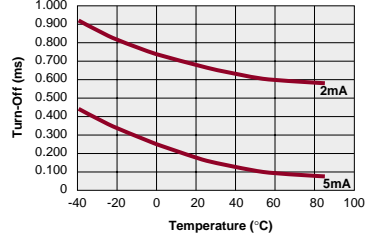

PERFORMANCE DATA

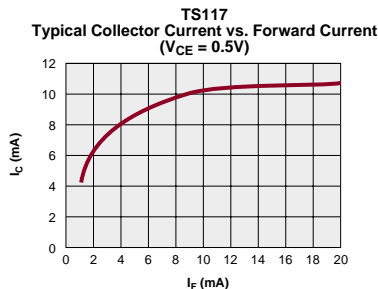
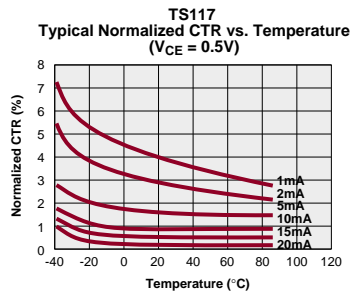
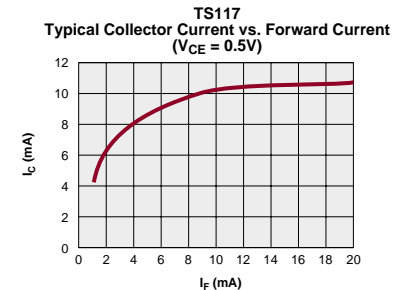
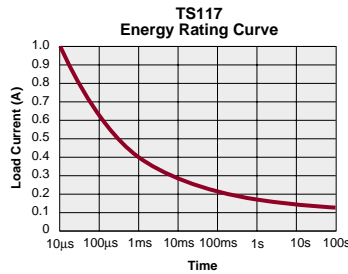
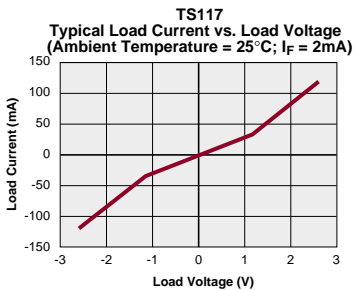
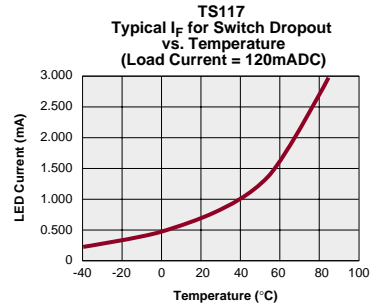
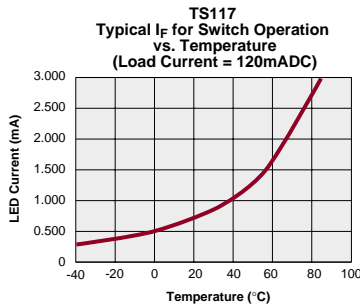
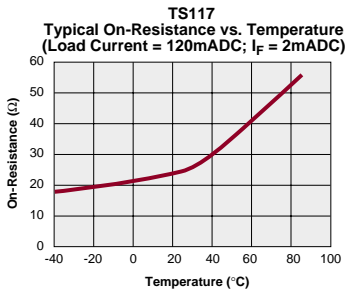
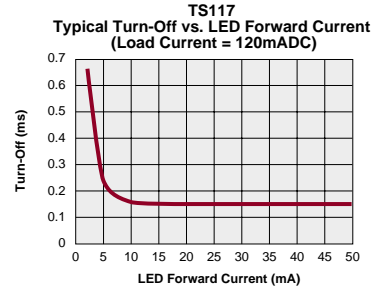
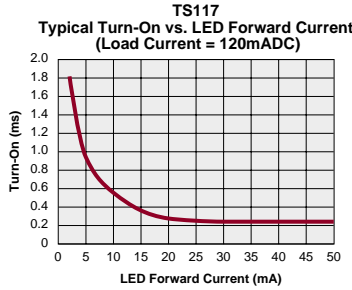
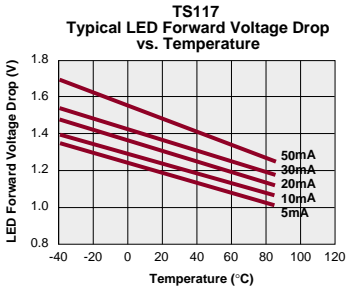

PERFORMANCE DATA

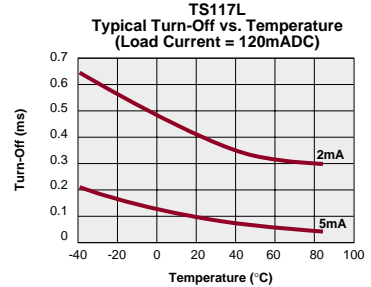
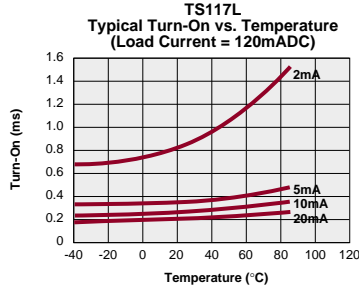
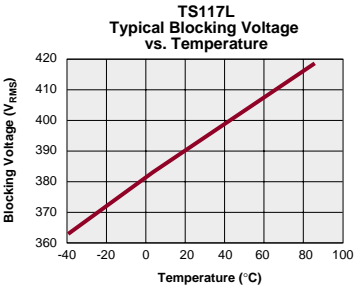
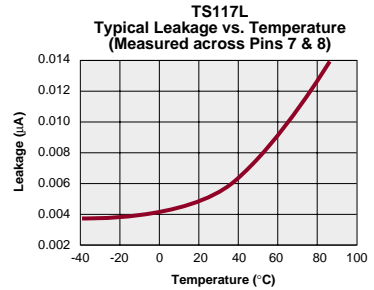
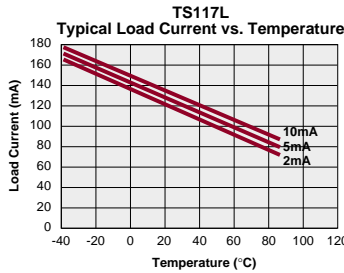
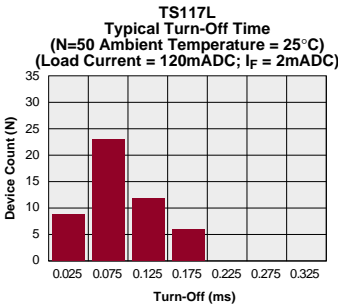
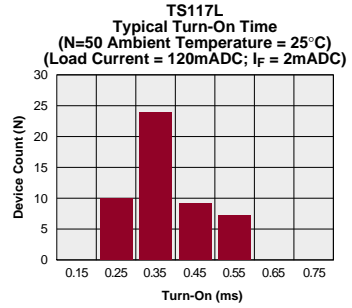
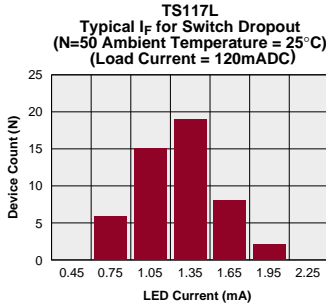
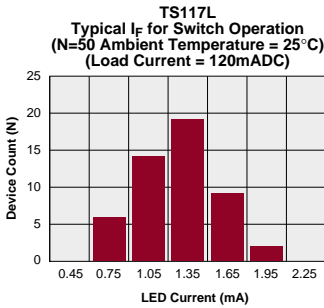
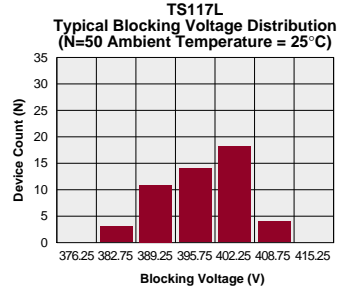
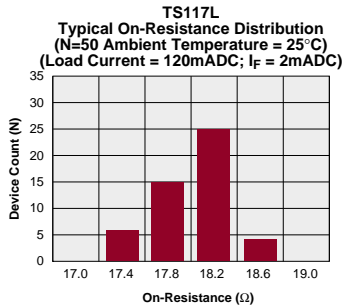
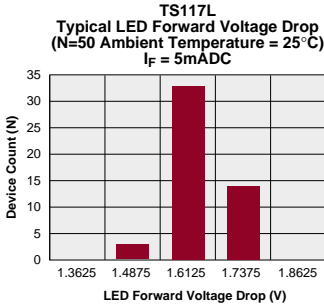

PERFORMANCE DATA

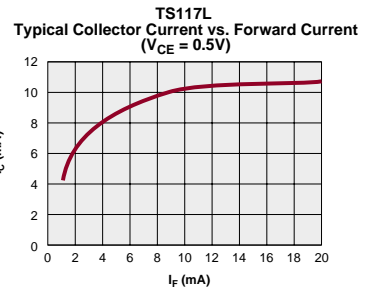
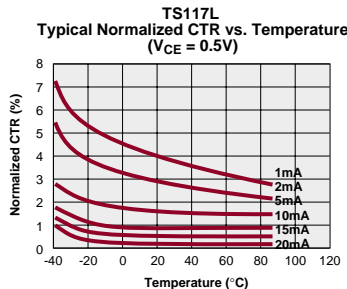
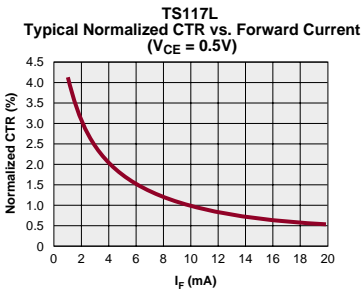
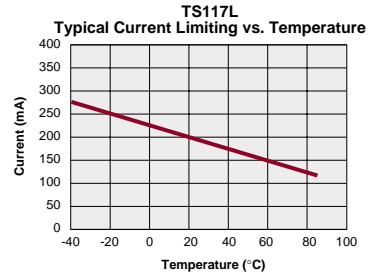
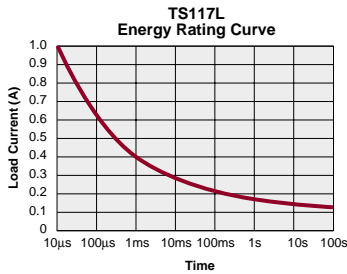
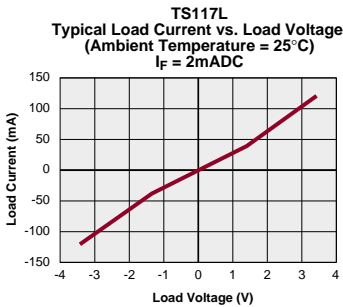
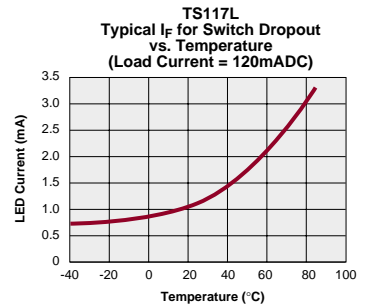
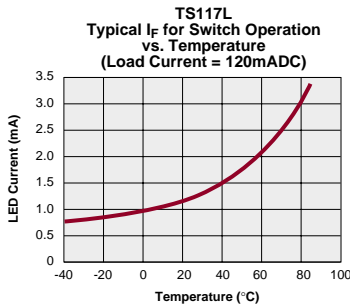
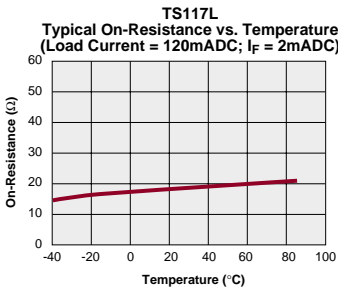
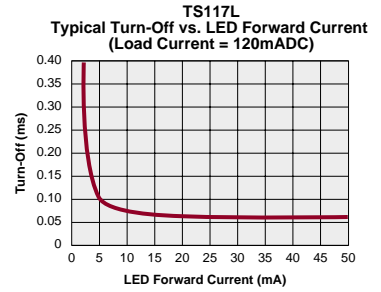
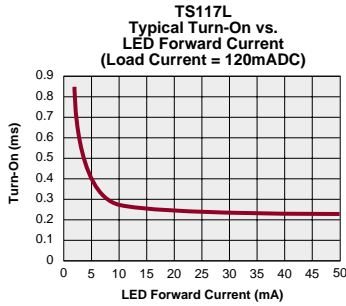
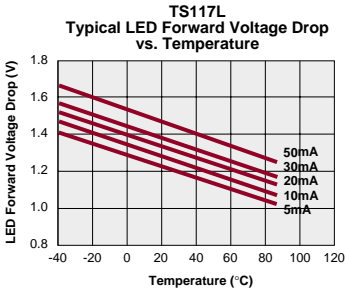

XS170



DESCRIPTION

The XS170 is a 350V, 120mA, 50Ω type 1-Form-A solid state relay for hookswitch combined with an optocoupler for detection of loop current or ringing signal in a single 8 pin DIP package.

FEATURES

- Small 8 Pin DIP Package
- Low Drive Power Requirements (TTL/CMOS Compatible)
- No Moving Parts
- High Reliability
- Arc-Free With No Snubbing Circuits
- 3750V_{RMS} Input/Output Isolation
- FCC Compatible
- VDE Compatible
- No EMI/RFI Generation
- Machine Insertable, Wave Solderable
- Surface Mount and Tape & Reel Versions Available

APPROVALS

- UL Recognized: File Number E76270
- CSA Certified: File Number LR 43639-10
- BSI Certified:
 - BS EN 60950:1992 (BS7002:1992) Certificate #:7344
 - BS EN 41003:1993 Certificate #:7344

OPTIONS / SUFFIXES

- P: Flatpack Package
- S: Surface Mount Package
- TR: Tape & Reel

XS170 Pinout

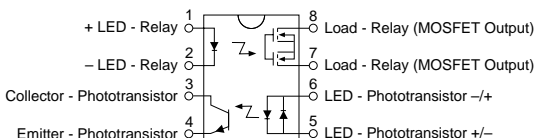

APPLICATIONS

- Telecommunications
 - Telecom Switching
 - Tip/Ring Circuits
 - Modem Switching (Laptop, Notebook, Pocket Size)
 - Hookswitch
 - Dial Pulsing
 - Ground Start
 - Ringer Injection
- Instrumentation
 - Multiplexers
 - Data Acquisition
 - Electronic Switching
 - I/O Subsystems
 - Meters (Watt-Hour, Water, Gas)
- Medical Equipment-Patient/Equipment Isolation
- Security
- Aerospace
- Industrial Controls

RATINGS (@ 25° C)

Parameter	Min	Typ	Max	Units
Input Power Dissipation	-	-	150 ¹	mW
Input Control Current	-	-	100	mA
Peak (10ms)	-	-	1	A
Reverse Input Voltage	-	-	5	V
Total Power Dissipation	-	-	800 ²	mW
Capacitance				
Input to Output	-	3	-	pF
Isolation Voltage				
Input to Output	3750	-	-	V _{RMS}
Operational Temperature	-40	-	+85	°C
Storage Temperature	-40	-	+125	°C
Soldering Temperature				
(10 Seconds Max.)				
DIP Package	-	-	+260	°C
Flatpack/Surface Mount Package	-	-	+220	°C

¹ Derate Linearly 1.33 mw/°C

² Derate Linearly 1.67 mw/°C

Note: For Mechanical Dimensions See Pages 396-401

SPECIFICATIONS

PARAMETERS	CONDITIONS	SYMBOL	MIN	TYP	MAX	UNITS
Relay Portion (Pins 7, 8) Output Characteristics @ 25°C						
Load Voltage (Peak)	-	V_L	-	-	350	V
Load Current (Continuous)	-	I_L	-	-	100	mA
Peak Load Current	10ms	I_{LPK}	-	-	350	mA
On-Resistance	$I_L=120mA$	R_{ON}	-	33	50	Ω
Off-State Leakage Current	$V_L=350V$	I_{LEAK}	-	-	1	μA
Switching Speeds						
Turn-On	$I_F=5mA, V_L=10V$	T_{ON}	-	-	5	ms
Turn-Off	$I_F=5mA, V_L=10V$	T_{OFF}	-	-	5	ms
Output Capacitance	50V; f=1MHz	C_{OUT}	-	25	-	pF
Load Current Limit		I_{CL}	-	-	-	mA
Relay Portion (Pins 1, 2) Input Characteristics @ 25°C						
Input Control Current	$I_L=120mA$	I_F	2	-	50	mA
Input Dropout Current	-	I_F	0.4	0.7	-	mA
Input Voltage Drop	$I_F=5mA$	V_F	0.9	1.2	1.4	V
Reverse Input Voltage	-	V_R	-	-	5	V
Reverse Input Current	$V_R=5V$	I_R	-	-	10	μA
Detector Portion (Pins 3, 4) Output Characteristics @ 25°C						
Phototransistor Blocking Voltage	$I_C=10\mu A$	BV_{CEO}	20	50	-	V
Phototransistor Output Current	$V_{CE}=5V, I_F=0mA$	I_{CEO}	-	50	500	nA
Saturation Voltage	$I_C=2mA, I_F=16mA$	V_{SAT}	-	0.3	0.5	V
Current Transfer Ratio	$I_F=6mA, V_{CE}=0.5V$	CTR	33	100	-	%
Detector Portion (Pins 5, 6) Input Characteristics @ 25°C						
Input Control Current	$I_C=2mA, V_{CE}=0.5V$	I_F	6	2	100	mA
Input Voltage Drop	$I_F=5mA$	V_F	0.9	1.2	1.4	V
Input Current (Detector must be off)	$I_C=1\mu A, V_{CE}=5V$	I_F	5	25	-	μA
Input to Output Capacitance (Relay Only)	-	$C_{I/O}$	-	3	-	pF
Input to Output Isolation	-	$V_{I/O}$	3750	-	-	V_{RMS}

Note: For Mechanical Dimensions See Pages 396-401

PERFORMANCE DATA

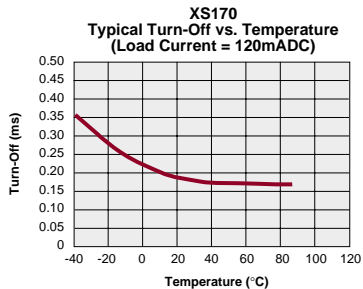
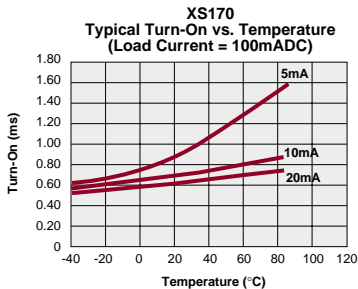
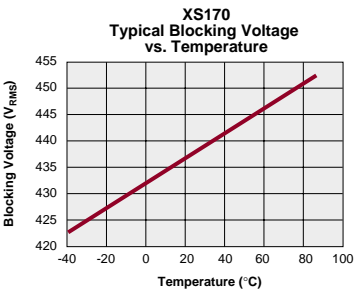
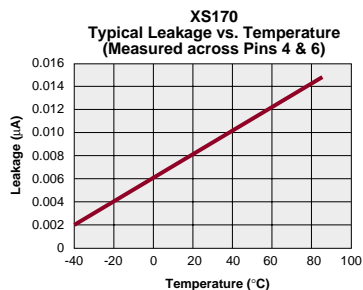
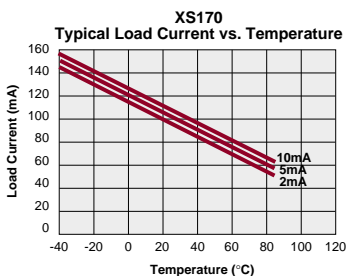
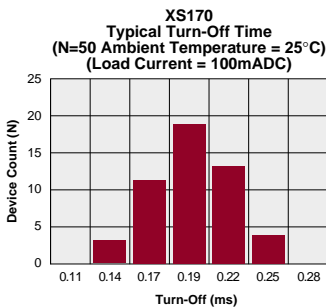
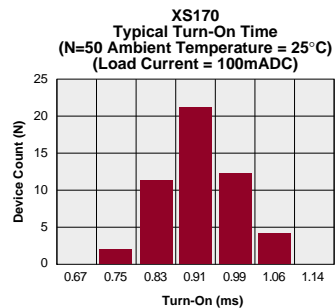
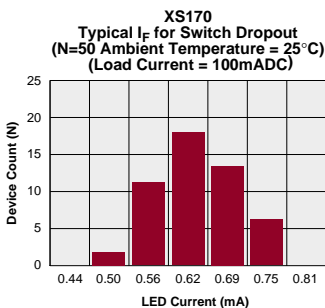
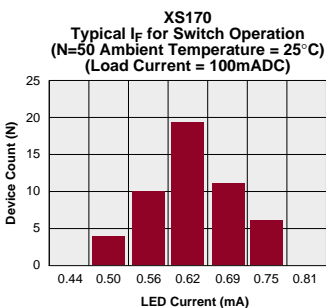
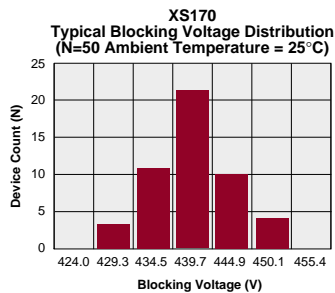
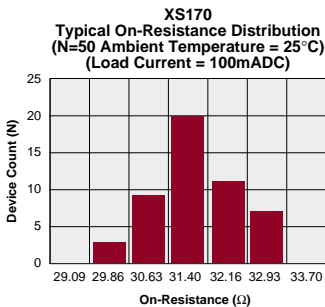
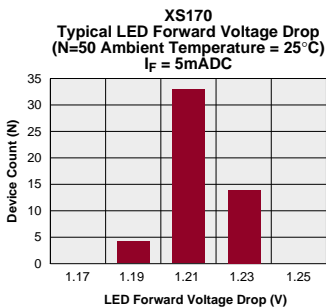

PERFORMANCE DATA

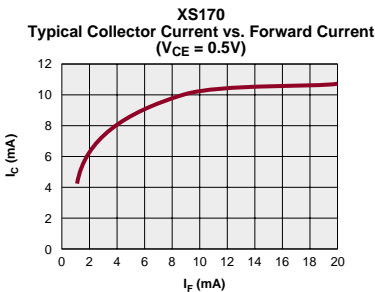
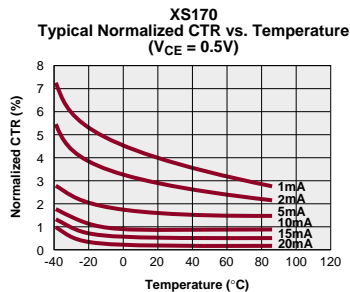
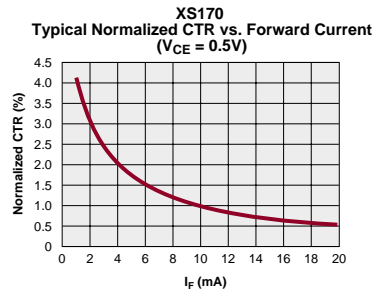
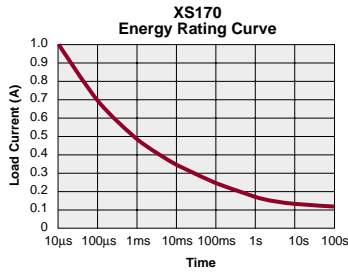
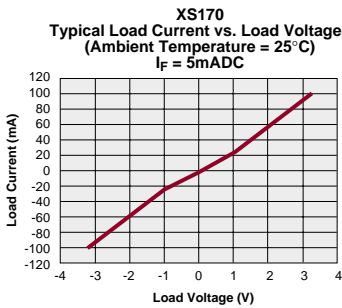
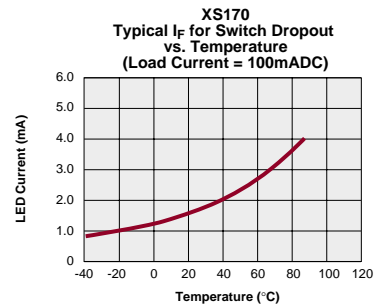
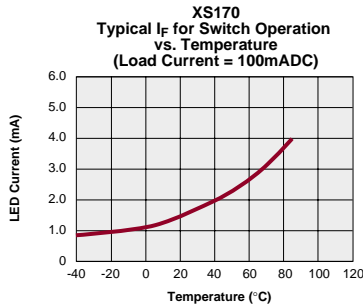
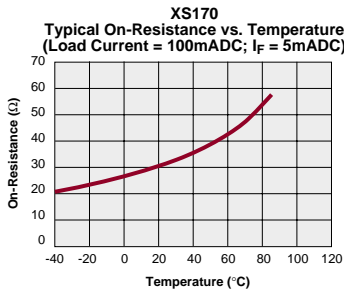
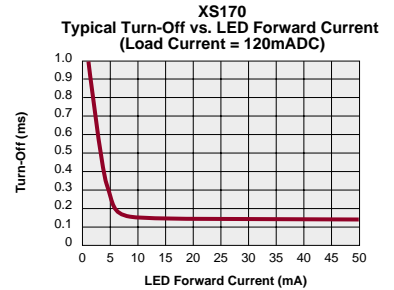
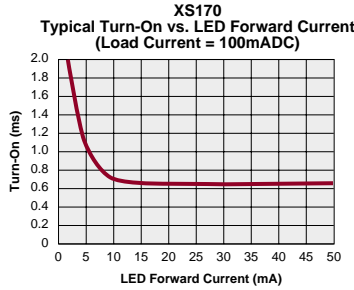
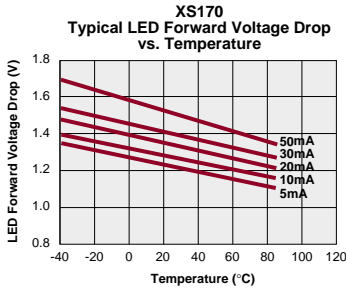

TS118



DESCRIPTION

The TS118 is a 350V, 120mA, 35Ω type 1-Form-B solid state relay for hookswitch combined with an optocoupler for detection of loop current or ringing signal in a single 8 pin DIP package.

FEATURES

- Small 8 Pin DIP Package
- Low Drive Power Requirements (TTL/CMOS Compatible)
- No Moving Parts
- High Reliability
- Arc-Free With No Snubbing Circuits
- 3750V_{RMS} Input/Output Isolation
- FCC Compatible
- VDE Compatible
- No EMI/RFI Generation
- Machine Insertable, Wave Solderable
- Surface Mount and Tape & Reel Versions Available

APPROVALS

- UL Recognized: File Number E76270
- CSA Certified: File Number LR 43639-10
- BSI Certified:
 - BS EN 60950:1992 (BS7002:1992) Certificate #:7344
 - BS EN 41003:1993 Certificate #:7344

OPTIONS / SUFFIXES

- P: Flatpack Package
- S: Surface Mount Package
- TR: Tape & Reel

TS118 Pinout

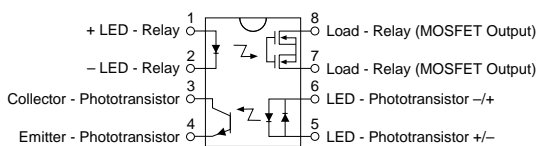

APPLICATIONS

- Telecommunications
 - Telecom Switching
 - Tip/Ring Circuits
 - Modem Switching (Laptop, Notebook, Pocket Size)
 - Hookswitch
 - Dial Pulsing
 - Ground Start
 - Ringer Injection
- Instrumentation
 - Multiplexers
 - Data Acquisition
 - Electronic Switching
 - I/O Subsystems
 - Meters (Watt-Hour, Water, Gas)
- Medical Equipment-Patient/Equipment Isolation
- Security
- Aerospace
- Industrial Controls

RATINGS (@ 25°C)

Parameter	Min	Typ	Max	Units
Input Power Dissipation	-	-	150 ¹	mW
Input Control Current	-	-	100	mA
Peak (10ms)	-	-	1	A
Reverse Input Voltage	-	-	5	V
Total Power Dissipation	-	-	800 ²	mW
Capacitance				
Input to Output	-	3	-	pF
Isolation Voltage				
Input to Output	3750	-	-	V _{RMS}
Operational Temperature	-40	-	+85	°C
Storage Temperature	-40	-	+125	°C
Soldering Temperature				
(10 Seconds Max.)				
DIP Package	-	-	+260	°C
Flatpack/Surface Mount Package	-	-	+220	°C

¹ Derate Linearly 1.33 mw/°C

² Derate Linearly 1.67 mw/°C

Note: For Mechanical Dimensions See Pages 396-401

SPECIFICATIONS

PARAMETERS	CONDITIONS	SYMBOL	MIN	TYP	MAX	UNITS
Relay Portion (Pins 7, 8) Output Characteristics @ 25°C						
Load Voltage (Peak)	-	V_L	-	-	350	V
Load Current (Continuous)	-	I_L	-	-	120	mA
Peak Load Current	10ms	I_{LPK}	-	-	350	mA
On-Resistance	$I_L=120\text{mA}$	R_{ON}	-	25	35	Ω
Off-State Leakage Current	$V_L=350\text{V}$	I_{LEAK}	-	-	1	μA
Switching Speeds						
Turn-On	$I_F=5\text{mA}, V_L=10\text{V}$	T_{ON}	-	-	3.0	ms
Turn-Off	$I_F=5\text{mA}, V_L=10\text{V}$	T_{OFF}	-	-	3.0	ms
Output Capacitance	50V; f=1MHz	C_{OUT}	-	25	-	pF
Relay Portion (Pins 1, 2) Input Characteristics @ 25°C						
Input Control Current	$I_L=120\text{mA}$	I_F	5	-	50	mA
Input Dropout Current	-	I_F	0.4	0.7	-	mA
Input Voltage Drop	$I_F=5\text{mA}$	V_F	0.9	1.2	1.4	V
Reverse Input Voltage	-	V_R	-	-	5	V
Reverse Input Current	$V_R=5\text{V}$	I_R	-	-	10	μA
Detector Portion (Pins 3, 4) Output Characteristics @ 25°C						
Phototransistor Blocking Voltage	$I_C=10\mu\text{A}$	BV_{CEO}	20	50	-	V
Phototransistor Output Current	$V_{CE}=5\text{V}, I_F=0\text{mA}$	I_{CEO}	-	50	500	nA
Saturation Voltage	$I_C=2\text{mA}, I_F=16\text{mA}$	V_{SAT}	-	0.3	0.5	V
Current Transfer Ratio	$I_F=6\text{mA}, V_{CE}=0.5\text{V}$	CTR	33	100	-	%
Detector Portion (Pins 5, 6) Input Characteristics @ 25°C						
Input Control Current	$I_C=2\text{mA}, V_{CE}=0.5\text{V}$	I_F	6	2	100	mA
Input Voltage Drop	$I_F=5\text{mA}$	V_F	0.9	1.2	1.4	V
Input Current (Detector must be off)	$I_C=1\mu\text{A}, V_{CE}=5\text{V}$	I_F	5	25	-	μA
Input to Output Capacitance (Relay Only)	-	$C_{I/O}$	-	3	-	pF
Input to Output Isolation	-	$V_{I/O}$	3750	-	-	V_{RMS}

Note: For Mechanical Dimensions See Pages 396-401

PERFORMANCE DATA

TS118
Typical LED Forward Voltage Drop
(N=50 Ambient Temperature = 25°C; I_F = 5mADC)

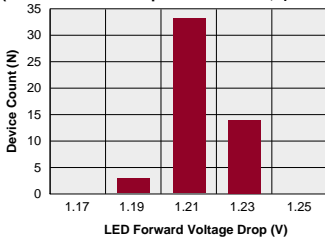

TS118
Typical On-Resistance Distribution
(N=50 Ambient Temperature = 25°C)
(Load Current = 120mADC; I_F = 5mADC)

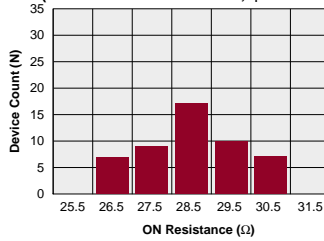

TS118
Typical Blocking Voltage Distribution
(N=50 Ambient Temperature = 25°C)

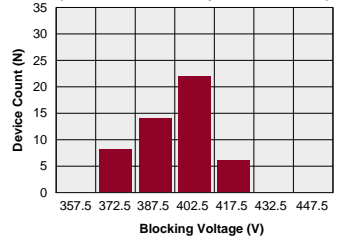

TS118
Typical I_F for Switch Operation
(N=50 Ambient Temperature = 25°C)
(Load Current = 120mADC)

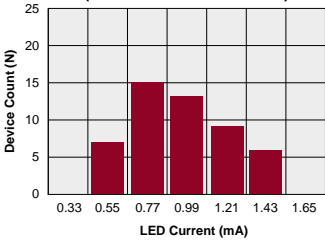

TS118
Typical I_F for Switch Dropout
(N=50 Ambient Temperature = 25°C)
(Load Current = 120mADC)

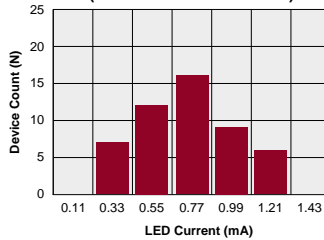

TS118
Typical Turn-On Time
(N=50 Ambient Temperature = 25°C)
(Load Current = 120mADC; I_F = 5mADC)

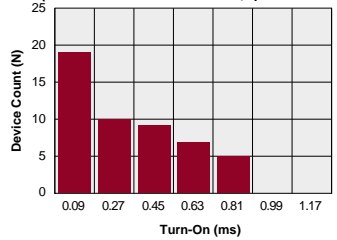

TS118
Typical Turn-Off Time
(N=50 Ambient Temperature = 25°C)
(Load Current = 120mADC; I_F = 5mADC)

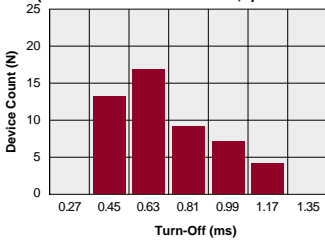

TS118
Typical Load Current vs. Temperature

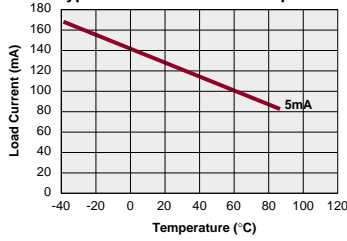

TS118
Typical Leakage vs. Temperature
(Measured across Pins 7 & 8)

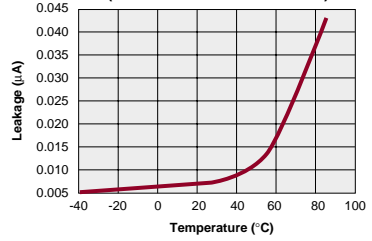

TS118
Typical Blocking Voltage vs. Temperature

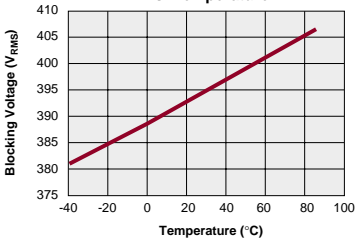

TS118
Typical Turn-On vs. Temperature
(Load Current = 120mADC)

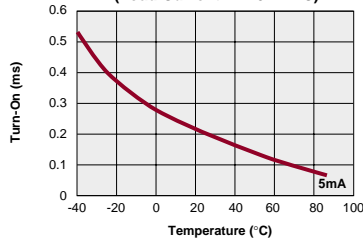

TS118
Typical Turn-Off vs. Temperature
(Load Current = 120mADC)

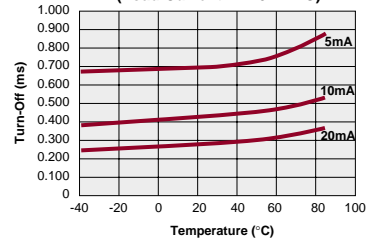

PERFORMANCE DATA

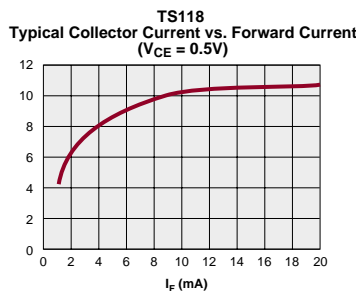
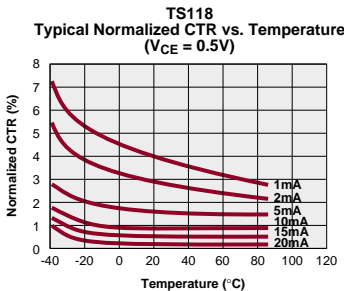
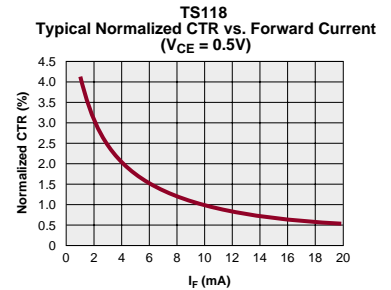
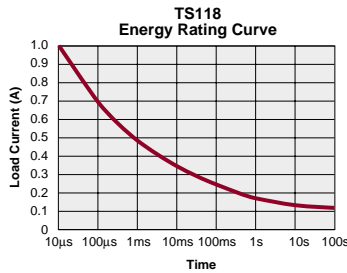
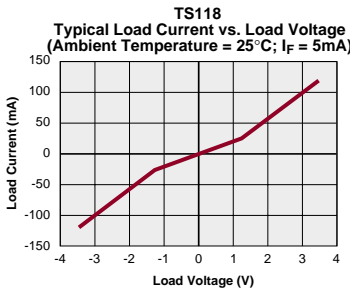
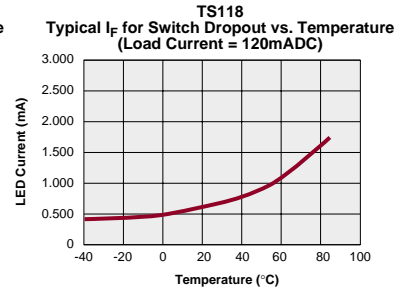
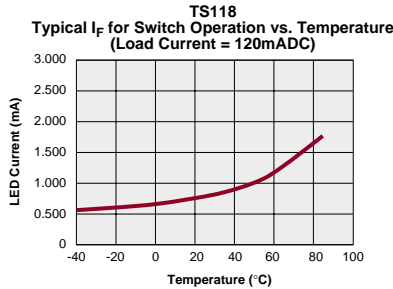
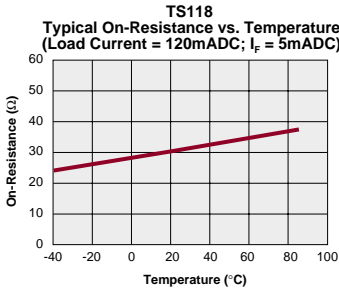
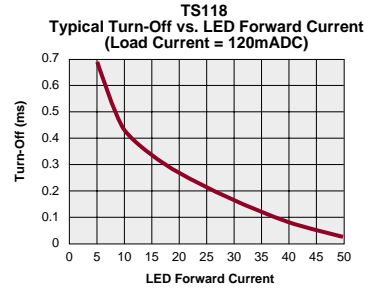
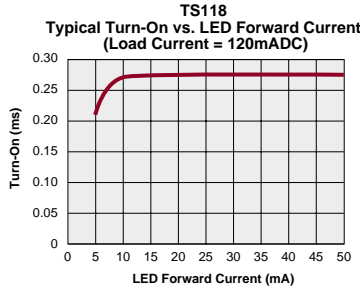
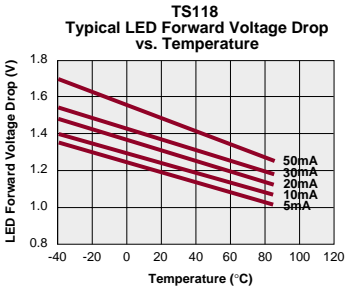

TS120



FEATURES

- Small 8 Pin DIP Package
- Low Drive Power Requirements (TTL/CMOS Compatible)
- No Moving Parts
- High Reliability
- Arc-Free With No Snubbing Circuits
- 3750V_{RMS} Input/Output Isolation
- FCC Compatible
- VDE Compatible
- No EMI/RFI Generation
- Machine Insertable, Wave Solderable
- Surface Mount and Tape & Reel Versions Available

APPROVALS

- UL Recognized: File Number E76270
- CSA Certified: File Number LR 43639-10
- BSI Certified:
 - BS EN 60950:1992 (BS7002:1992) Certificate #:7344
 - BS EN 41003:1993 Certificate #:7344

OPTIONS / SUFFIXES

- P: Flatpack Package
- S: Surface Mount Package
- TR: Tape & Reel

DESCRIPTION

The TS120 is a 350V, 120mA, 35Ω type 1-Form-A solid state relay for hookswitch combined with an optocoupler for detection of loop current or ringing signal in a single 8 pin DIP package.

APPLICATIONS

- Telecommunications
 - Telecom Switching
 - Tip/Ring Circuits
 - Modem Switching (Laptop, Notebook, Pocket Size)
 - Hookswitch
 - Dial Pulsing
 - Ground Start
 - Ringer Injection
- Instrumentation
 - Multiplexers
 - Data Acquisition
 - Electronic Switching
 - I/O Subsystems
 - Meters (Watt-Hour, Water, Gas)
- Medical Equipment-Patient/Equipment Isolation
- Security
- Aerospace
- Industrial Controls

RATINGS (@ 25 ° C)

Parameter	Min	Typ	Max	Units
Input Power Dissipation	-	-	150 ¹	mW
Input Control Current	-	-	100	mA
Peak (10ms)	-	-	1	A
Reverse Input Voltage	-	-	5	V
Total Power Dissipation	-	-	800 ²	mW
Capacitance				
Input to Output	-	3	-	pF
Isolation Voltage				
Input to Output	3750	-	-	V _{RMS}
Operational Temperature	-40	-	+85	°C
Storage Temperature	-40	-	+125	°C
Soldering Temperature (10 Seconds Max.)				
DIP Package	-	-	+260	°C
Flatpack/Surface Mount Package	-	-	+220	°C

¹ Derate Linearly 1.33 mw/°C

² Derate Linearly 1.67 mw/°C

TS120 Pinout

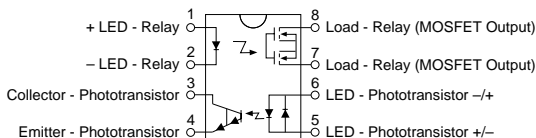

Note: For Mechanical Dimensions See Pages 396-401

SPECIFICATIONS

PARAMETERS	CONDITIONS	SYMBOL	MIN	TYP	MAX	UNITS
Relay Portion (Pins 7, 8)						
Output Characteristics @ 25° C						
Load Voltage (Peak)	-	V_L	-	-	350	V
Load Current (Continuous)	-	I_L	-	-	120	mA
Peak Load Current	10ms	I_{LPK}	-	-	350	mA
On-Resistance	$I_L=120mA$	R_{ON}	-	23	35	Ω
Off-State Leakage Current	$V_L=350V$	I_{LEAK}	-	-	1	μA
Switching Speeds						
Turn-On	$I_F=5mA, V_L=10V$	T_{ON}	-	-	3.0	ms
Turn-Off	$I_F=5mA, V_L=10V$	T_{OFF}	-	-	3.0	ms
Output Capacitance	50V; f=1MHz	C_{OUT}	-	25	-	pF
Relay Portion (Pins 1, 2)						
Input Characteristics @ 25° C						
Input Control Current	$I_L=120mA$	I_F	5	-	50	mA
Input Dropout Current	-	I_F	0.4	0.7	-	mA
Input Voltage Drop	$I_F=5mA$	V_F	0.9	1.2	1.4	V
Reverse Input Voltage	-	V_R	-	-	5	V
Reverse Input Current	$V_R=5V$	I_R	-	-	10	μA
Detector Portion (Pins 3, 4)						
Output Characteristics @ 25° C						
Phototransistor Blocking Voltage	$I_C=10\mu A$	BV_{CEO}	20	50	-	V
Phototransistor Output Current	$V_{CE}=5V, I_F=0mA$	I_{CEO}	-	100	1000	nA
Saturation Voltage	$I_C=0.15mA, I_F=.05mA$	V_{SAT}	-	0.5	0.8	V
Current Transfer Ratio	$I_F=0.05mA, V_{CE}=0.8V$	CTR	300	1000	-	%
Detector Portion (Pins 5, 6)						
Input Characteristics @ 25° C						
Input Control Current	$I_C=2mA, V_{CE}=0.5V$	I_F	2	1	100	mA
Input Voltage Drop	$I_F=5mA$	V_F	0.9	1.2	1.4	V
Input to Output Capacitance (Relay Only)	-	C_{VO}	-	3	-	pF
Input to Output Isolation	-	V_{VO}	3750	-	-	V_{RM}

Note: For Mechanical Dimensions See Pages 396-401

www.cpcclare.com

PERFORMANCE DATA

TS120
Typical LED Forward Voltage Drop
(N=50 Ambient Temperature = 25°C; I_F = 5mADC)

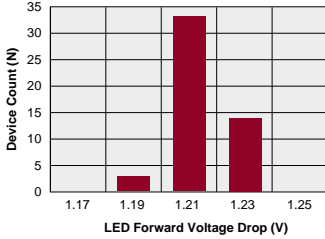

TS120
Typical On-Resistance Distribution
(N=50 Ambient Temperature = 25°C)
(Load Current = 120mADC, I_F = 5mADC)

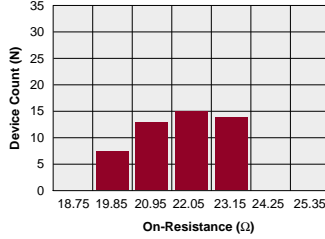

TS120
Typical Blocking Voltage Distribution
(N=50 Ambient Temperature = 25°C)

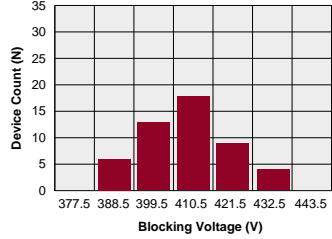

TS120
Typical I_F for Switch Operation
(N=50 Ambient Temperature = 25°C)
(Load Current = 120mADC)

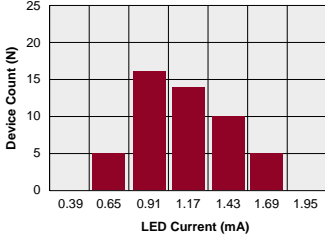

TS120
Typical I_F for Switch Dropout
(N=50 Ambient Temperature = 25°C)
(Load Current = 120mADC)

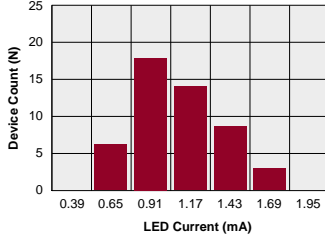

TS120
Typical Turn-On Time
(N=50 Ambient Temperature = 25°C)
(Load Current = 120mADC; I_F = 5mADC)

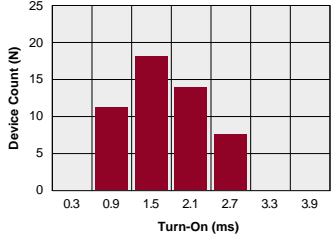

TS120
Typical Turn-Off Time
(N=50 Ambient Temperature = 25°C)
(Load Current = 120mADC; I_F = 5mADC)

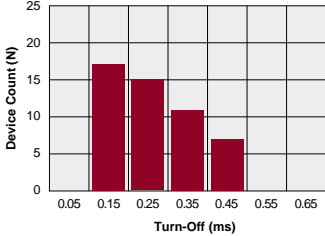

TS120
Typical Load Current vs. Temperature

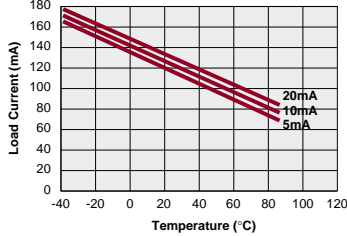

TS120
Typical Leakage vs. Temperature
(Measured across Pins 7 & 8)

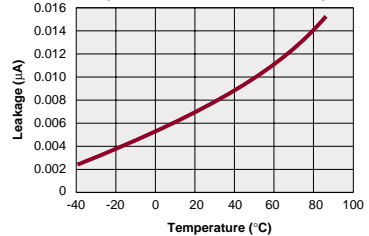

TS120
Typical Blocking Voltage vs. Temperature

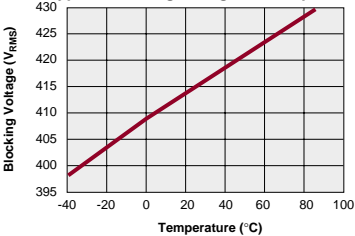

TS120
Typical Turn-On vs. Temperature
(Load Current = 120mADC)

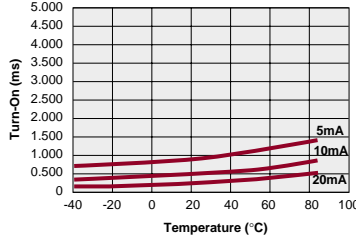

TS120
Typical Turn-Off vs. Temperature
(Load Current = 120mADC)

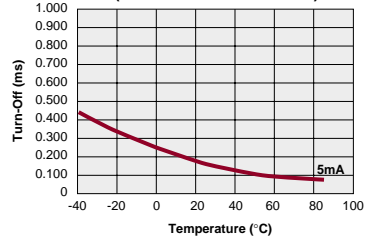

PERFORMANCE DATA

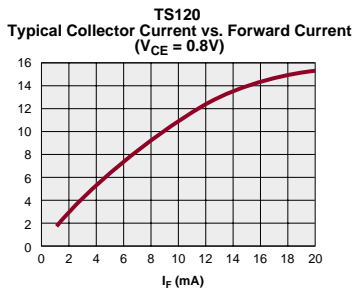
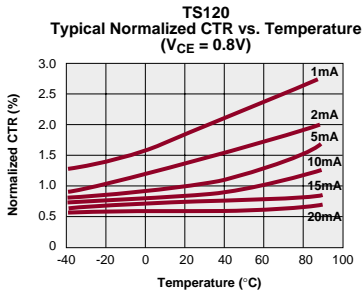
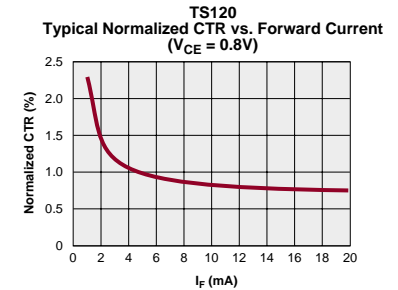
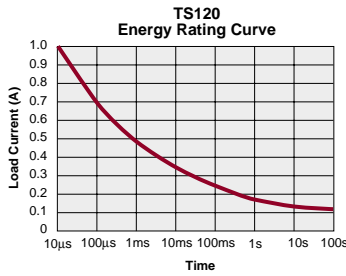
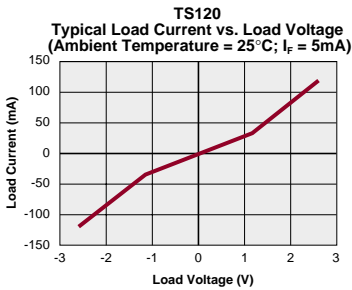
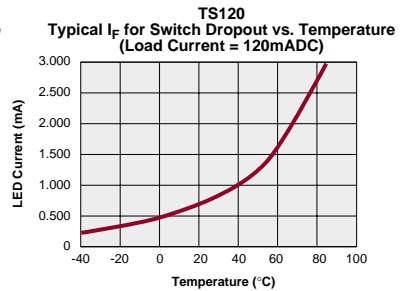
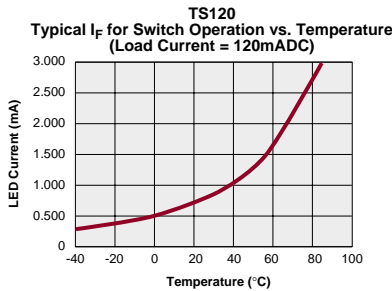
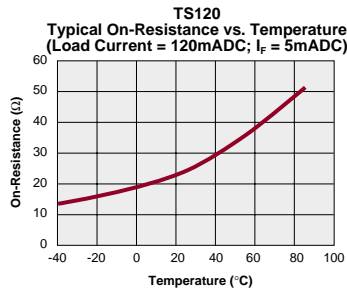
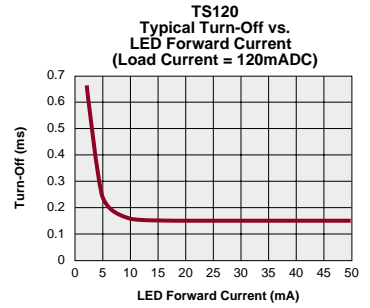
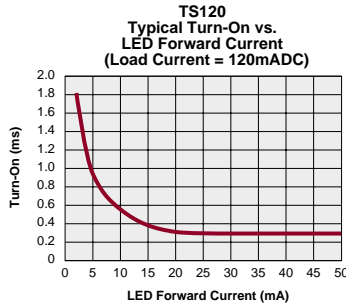
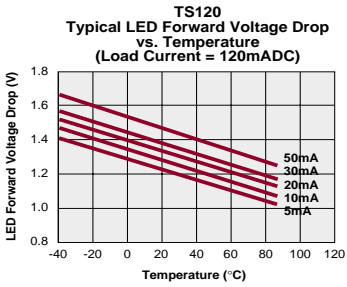

TS122



DESCRIPTION

The TS122 is a 250V, 170mA, 20Ω type 1-Form-A solid state relay for hookswitch combined with an optocoupler for detection of loop current or ringing signal in a single 8 pin DIP package.

FEATURES

- Small 8 Pin DIP Package
- Low Drive Power Requirements (TTL/CMOS Compatible)
- No Moving Parts
- High Reliability
- Arc-Free With No Snubbing Circuits
- 3750V_{RMS} Input/Output Isolation
- FCC Compatible
- VDE Compatible
- No EMI/RFI Generation
- Machine Insertable, Wave Solderable
- Surface Mount and Tape & Reel Versions Available

APPROVALS

- UL Recognized: File Number E76270
- CSA Certified: File Number LR 43639-10
- BSI Certified:
 - BS EN 60950:1992 (BS7002:1992) Certificate #:7344
 - BS EN 41003:1993 Certificate #:7344

OPTIONS / SUFFIXES

- P: Flatpack Package
- S: Surface Mount Package
- TR: Tape & Reel

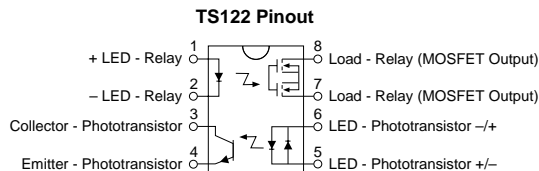

APPLICATIONS

- Telecommunications
 - Telecom Switching
 - Tip/Ring Circuits
 - Modem Switching (Laptop, Notebook, Pocket Size)
 - Hookswitch
 - Dial Pulsing
 - Ground Start
 - Ringer Injection
- Instrumentation
 - Multiplexers
 - Data Acquisition
 - Electronic Switching
 - I/O Subsystems
 - Meters (Watt-Hour, Water, Gas)
- Medical Equipment-Patient/Equipment Isolation
- Security
- Aerospace
- Industrial Controls

RATINGS (@ 25° C)

Parameter	Min	Typ	Max	Units
Input Power Dissipation	-	-	150 ¹	mW
Input Control Current	-	-	100	mA
Peak (10ms)	-	-	1	A
Reverse Input Voltage	-	-	5	V
Total Power Dissipation	-	-	800 ²	mW
Capacitance				
Input to Output	-	3	-	pF
Isolation Voltage				
Input to Output	3750	-	-	V _{RMS}
Operational Temperature	-40	-	+85	°C
Storage Temperature	-40	-	+125	°C
Soldering Temperature (10 Seconds Max.)				
DIP Package	-	-	+260	°C
Flatpack/Surface Mount Package	-	-	+220	°C

¹ Derate Linearly 1.33 mw/°C

² Derate Linearly 1.67 mw/°C

Note: For Mechanical Dimensions See Pages 396-401

SPECIFICATIONS

PARAMETERS	CONDITIONS	SYMBOL	MIN	TYP	MAX	UNITS
Relay Portion (Pins 7, 8) Output Characteristics @ 25°C						
Load Voltage (Peak)	-	V_L	-	-	250	V
Load Current (Continuous)	-	I_L	-	-	170	mA
Peak Load Current	10ms	I_{LPK}	-	-	400	mA
On-Resistance	$I_L=170mA$	R_{ON}	-	12	20	Ω
Off-State Leakage Current	$V_L=250V$	I_{LEAK}	-	-	1	μA
Switching Speeds						
Turn-On	$I_F=5mA, V_L=10V$	T_{ON}	-	-	5.0	ms
Turn-Off	$I_F=5mA, V_L=10V$	T_{OFF}	-	-	5.0	ms
Output Capacitance	50V; f=1MHz	C_{OUT}	-	50	-	pF
Relay Portion (Pins 1, 2) Input Characteristics @ 25°C						
Input Control Current	$I_L=170mA$	I_F	5	-	50	mA
Input Dropout Current	-	I_F	0.4	0.7	-	mA
Input Voltage Drop	$I_F=5mA$	V_F	0.9	1.2	1.4	V
Reverse Input Voltage	-	V_R	-	-	5	V
Reverse Input Current	$V_R=5V$	I_R	-	-	10	μA
Detector Portion (Pins 3, 4) Output Characteristics @ 25°C						
Phototransistor Blocking Voltage	$I_C=10\mu A$	BV_{CEO}	20	50	-	V
Phototransistor Output Current	$V_{CE}=5V, I_F=0mA$	I_{CEO}	-	50	500	nA
Saturation Voltage	$I_C=2mA, I_F=16mA$	V_{SAT}	-	0.3	0.5	V
Current Transfer Ratio	$I_F=6mA, V_{CE}=0.5V$	CTR	33	100	-	%
Detector Portion (Pins 5, 6) Input Characteristics @ 25°C						
Input Control Current	$I_C=2mA, V_{CE}=0.5V$	I_F	6	2	100	mA
Input Voltage Drop	$I_F=5mA$	V_F	0.9	1.2	1.4	V
Input Current (Detector must be off)	$I_C=1\mu A, V_{CE}=5V$	I_F	5	25	-	μA
Input to Output Capacitance (Relay Only)	-	$C_{I/O}$	-	3	-	pF
Input to Output Isolation	-	$V_{I/O}$	3750	-	-	V_{RMS}

Note: For Mechanical Dimensions See Pages 396-401

TS122

PERFORMANCE DATA

TS122
Typical LED Forward Voltage Drop
(N=50 Ambient Temperature = 25°C; I_F = 5mADC)

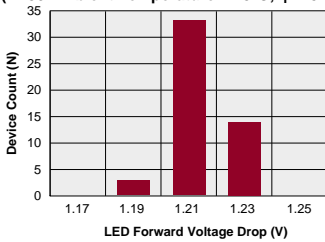

TS122
Typical On-Resistance Distribution
(N=50 Ambient Temperature = 25°C)
(Load: Voltage = 250VDC; Current = 170mADC;
I_F = 5mADC)

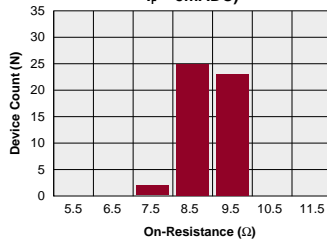

TS122
Typical Blocking Voltage Distribution
(N=50 Ambient Temperature = 25°C)

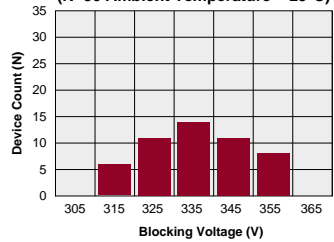

TS122
Typical I_F for Switch Operation
(N=50 Ambient Temperature = 25°C)
(Load Current = 170mADC)

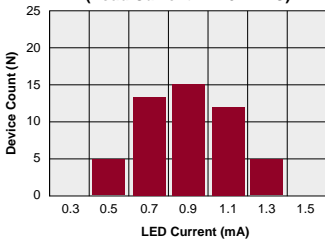

TS122
Typical I_F for Switch Dropout
(N=50 Ambient Temperature = 25°C)
(Load Current = 170mADC)

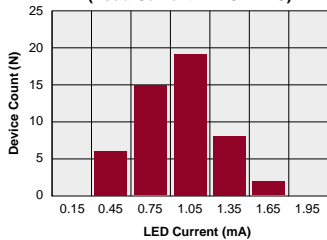

TS122
Typical Turn-On Time
(N=50 Ambient Temperature = 25°C)
(Load Current = 170mADC; I_F = 5mADC)

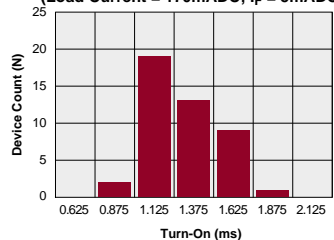

TS122
Typical Turn-Off Time
(N=50 Ambient Temperature = 25°C)
(Load Current = 170mADC; I_F = 5mADC)

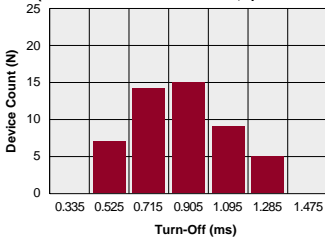

TS122
Typical Load Current vs. Temperature

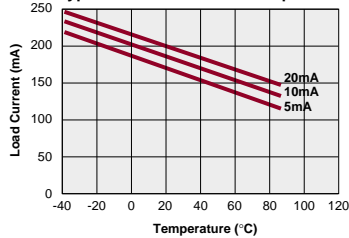

TS122
Typical Leakage vs. Temperature
(Measured across Pins 7 & 8)

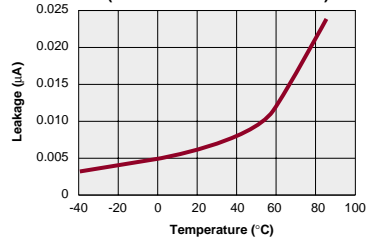

TS122
Typical Blocking Voltage vs. Temperature

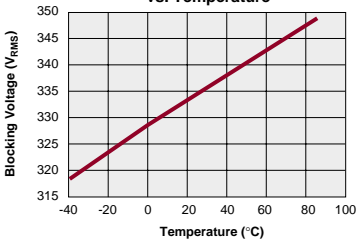

TS122
Typical Turn-On vs. Temperature
(Load Current = 170mADC)

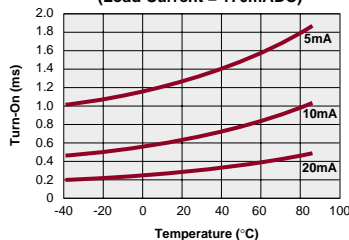

TS122
Typical Turn-Off vs. Temperature
(Load Current = 170mADC)

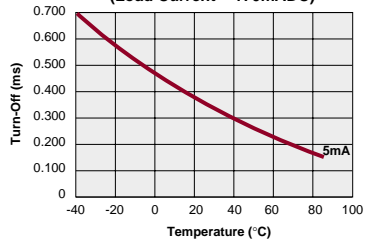

PERFORMANCE DATA

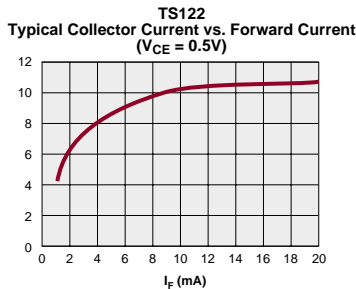
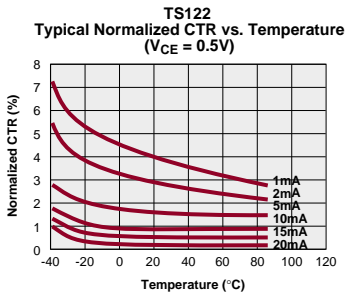
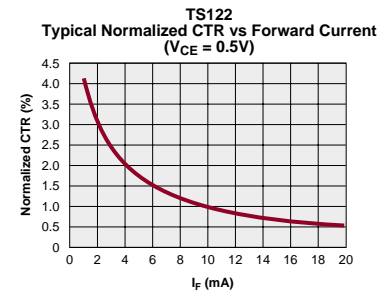
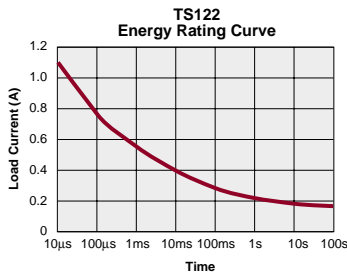
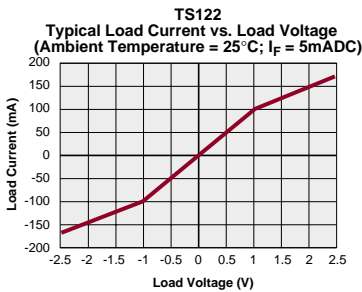
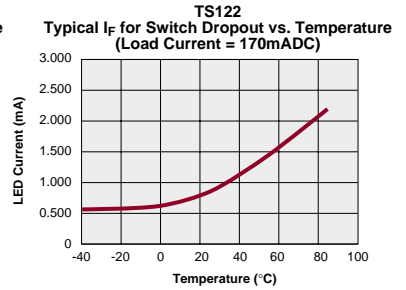
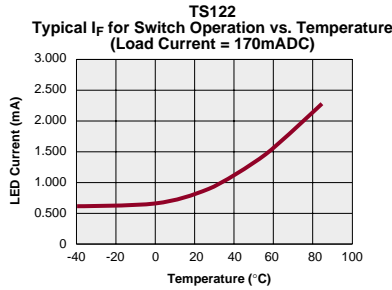
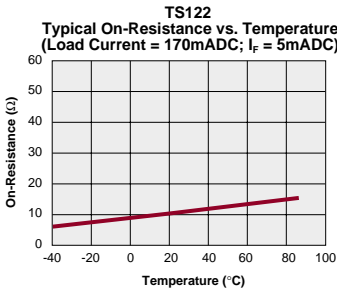
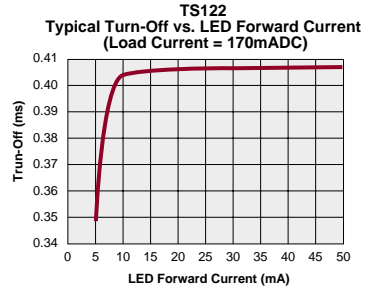
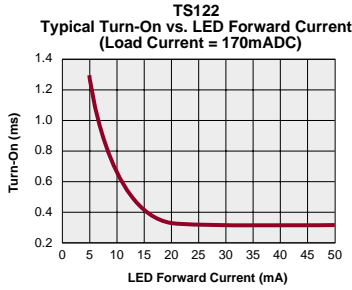
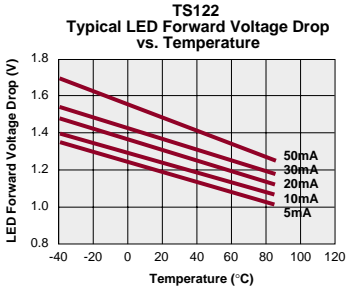

MULTIFUNCTION TELECOM SWITCH

TS190/TS190L



FEATURES

- Small 8 Pin DIP Package
- Low Drive Power Requirements (TTL/CMOS Compatible)
- No Moving Parts
- High Reliability
- Arc-Free With No Snubbing Circuits
- 3750V_{RMS} Input/Output Isolation
- FCC Compatible
- VDE Compatible
- No EMI/RFI Generation
- Machine Insertable, Wave Solderable
- Surface Mount and Tape & Reel Versions Available

APPROVALS

- UL Recognized: File Number E76270
- CSA Certified: File Number LR 43639-10
- BSI Certified:
 - BS EN 60950:1992 (BS7002:1992) Certificate #:7344
 - BS EN 41003:1993 Certificate #:7344

OPTIONS / SUFFIXES

- P: Flatpack Package
- L: Current Limiting
- S: Surface Mount Package
- TR: Tape & Reel

TS190/TS190L Pinout

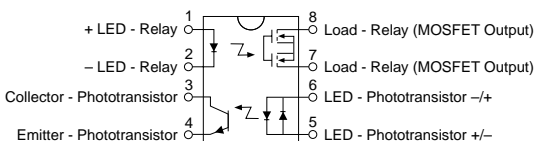

DESCRIPTION

The TS190 is a 400V, 150mA, 22Ω type 1-Form-A solid state relay for hookswitch combined with an optocoupler for detection of loop current or ringing signal in a single 8 pin DIP package. Current limiting version available ("L" suffix).

APPLICATIONS

- Telecommunications
 - Telecom Switching
 - Tip/Ring Circuits
 - Modem Switching (Laptop, Notebook, Pocket Size)
 - Hookswitch
 - Dial Pulsing
 - Ground Start
 - Ringer Injection
- Instrumentation
 - Multiplexers
 - Data Acquisition
 - Electronic Switching
 - I/O Subsystems
 - Meters (Watt-Hour, Water, Gas)
- Medical Equipment-Patient/Equipment Isolation
- Security
- Aerospace
- Industrial Controls

RATINGS (@ 25°C)

Parameter	Min	Typ	Max	Units
Input Power Dissipation	-	-	150 ¹	mW
Input Control Current	-	-	100	mA
Peak (10ms)	-	-	1	A
Reverse Input Voltage	-	-	5	V
Total Power Dissipation	-	-	800 ²	mW
Capacitance				
Input to Output	-	3	-	pF
Isolation Voltage				
Input to Output	3750	-	-	V _{RMS}
Operational Temperature	-40	-	+85	°C
Storage Temperature	-40	-	+125	°C
Soldering Temperature (10 Seconds Max.)				
DIP Package	-	-	+260	°C
Flatpack/Surface Mount Package	-	-	+220	°C

¹ Derate Linearly 1.33 mw/°C

² Derate Linearly 1.67 mw/°C

Note: For Mechanical Dimensions See Pages 396-401

SPECIFICATIONS

TS190

TS190L

PARAMETERS	CONDITIONS	SYMBOL	MIN	TYP	MAX	MIN	TYP	MAX	UNITS
Relay Portion (Pins 7, 8) Output Characteristics @ 25°C									
Load Voltage (Peak)	-	V_L	-	-	400	-	-	400	V
Load Current (Continuous)	-	I_L	-	-	150	-	-	150	mA
Peak Load Current	10ms	I_{LPK}	-	-	400	-	-	-	mA
On-Resistance	$I_L=150mA$	R_{ON}	-	15	22	-	18	25	Ω
Off-State Leakage Current	$V_L=400V$	I_{LEAK}	-	-	1	-	-	1	μA
Switching Speeds									
Turn-On	$I_F=5mA, V_L=10V$	T_{ON}	-	-	1	-	-	1	ms
Turn-Off	$I_F=5mA, V_L=10V$	T_{OFF}	-	-	0.25	-	-	0.25	ms
Output Capacitance	50V; $f=1MHz$	C_{OUT}	-	25	-	-	25	-	pF
Load Current Limit		I_{CL}	-	-	-	190	235	280	mA
Relay Portion (Pins 1, 2) Input Characteristics @ 25°C									
Input Control Current	$I_L=150mA$	I_F	5	-	50	5	-	50	mA
Input Dropout Current	-	I_F	0.4	0.7	-	0.4	0.7	-	mA
Input Voltage Drop	$I_F=5mA$	V_F	0.9	1.2	1.4	0.9	1.2	1.4	V
Reverse Input Voltage	-	V_R	-	-	5	-	-	5	V
Reverse Input Current	$V_R=5V$	I_R	-	-	10	-	-	10	μA
Detector Portion (Pins 3,4) Output Characteristics @ 25°C									
Phototransistor Blocking Voltage	$I_C=10\mu A$	BV_{CEO}	20	50	-	20	50	-	V
Phototransistor Output Current	$V_{CE}=5V, I_F=0mA$	I_{CEO}	-	50	500	-	50	500	nA
Saturation Voltage	$I_C=2mA, I_F=16mA$	V_{SAT}	-	0.3	0.5	-	0.3	0.5	V
Current Transfer Ratio	$I_F=6mA, V_{CE}=0.5V$	CTR	33	100	-	33	100	-	%
Detector Portion (Pins 5,6) Input Characteristics @ 25°C									
Input Control Current	$I_C=2mA, V_{CE}=0.5V$	I_F	6	2	100	6	2	100	mA
Input Voltage Drop	$I_F=5mA$	V_F	0.9	1.2	1.4	0.9	1.2	1.4	V
Input Current (Detector must be off)	$I_C=1\mu A, V_{CE}=5V$	I_F	5	25	-	5	25	-	μA
Input to Output Capacitance (Relay Only)	-	$C_{I/O}$	-	3	-	-	3	-	pF
Input to Output Isolation	-	$V_{I/O}$	3750	-	-	3750	-	-	V_{RMS}

Note: For Mechanical Dimensions See Pages 396-401

PERFORMANCE DATA

TS190
Typical LED Forward Voltage Drop
(N=50 Ambient Temperature = 25°C; I_F = 5mADC)

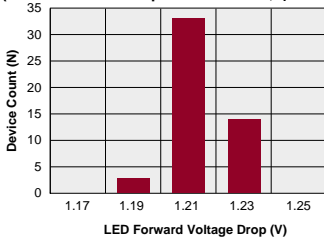

TS190
Typical On-Resistance Distribution
(N=50 Ambient Temperature = 25°C)
(Load Current = 150mADC; I_F = 5mADC)

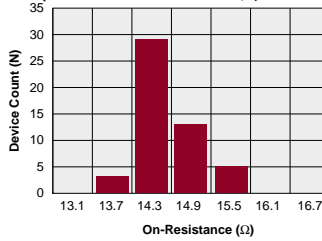

TS190
Typical Blocking Voltage Distribution
(N=50 Ambient Temperature = 25°C)

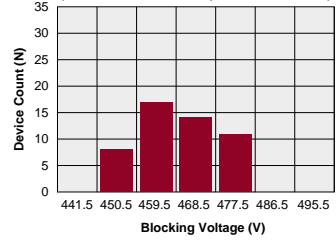

TS190
Typical I_F for Switch Operation
(N=50 Ambient Temperature = 25°C)
(Load Current = 150mADC)

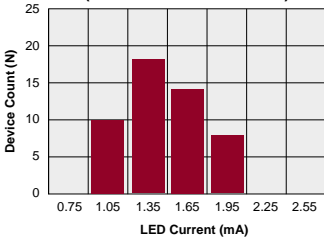

TS190
Typical I_F for Switch Dropout
(N=50 Ambient Temperature = 25°C)
Load Current = 150mA

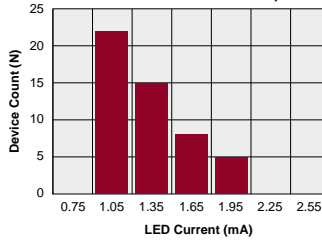

TS190
Typical Turn-On Time
(N=50 Ambient Temperature = 25°C)
(Load Current = 150mADC; I_F = 5mADC)

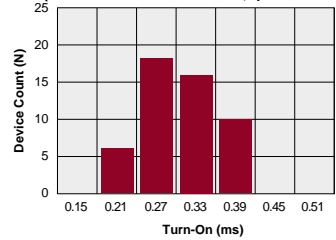

TS190
Typical Turn-Off Time
(N=50 Ambient Temperature = 25°C)
(Load Current = 150mADC; I_F = 5mADC)

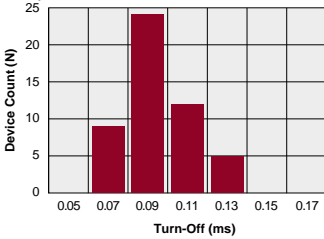

TS190
Typical Load Current vs. Temperature

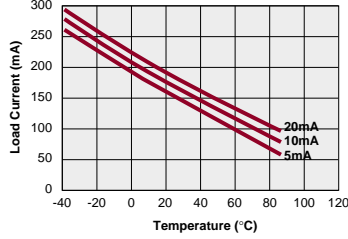

TS190
Typical Leakage vs. Temperature
(Measured across Pins 7 & 8)

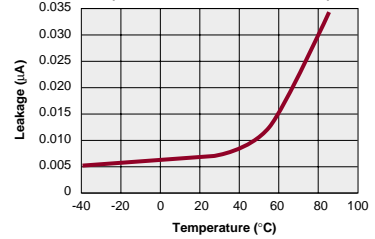

TS190
Typical Blocking Voltage vs. Temperature

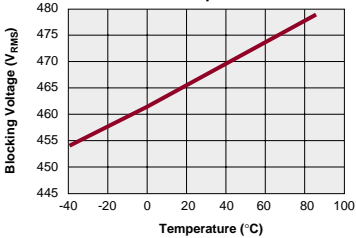

TS190
Typical Turn-On vs. Temperature
(Load Current = 150mADC)

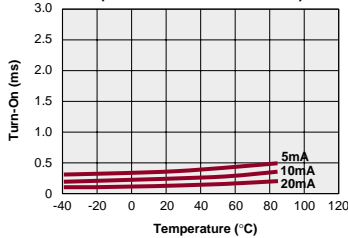

TS190
Typical Turn-Off vs. Temperature
(Load Current = 150mADC)

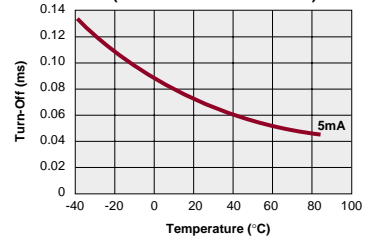

PERFORMANCE DATA

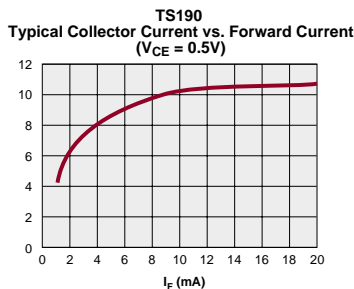
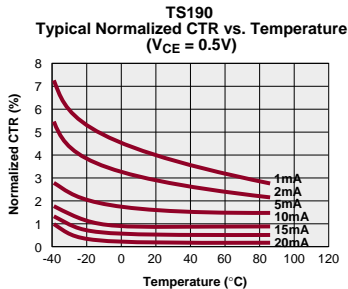
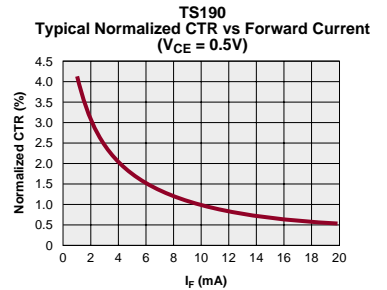
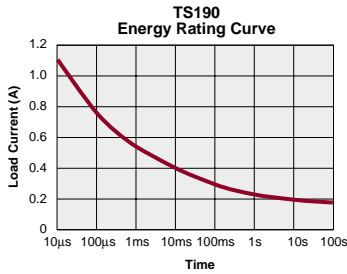
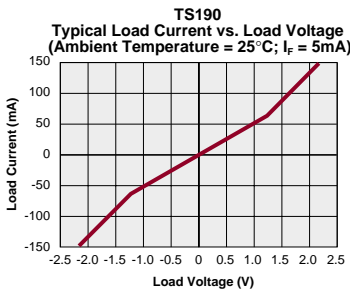
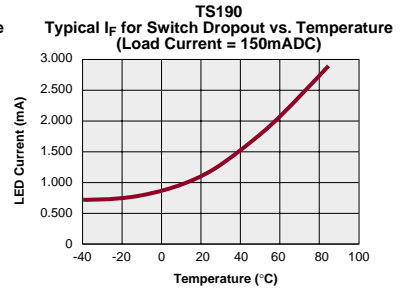
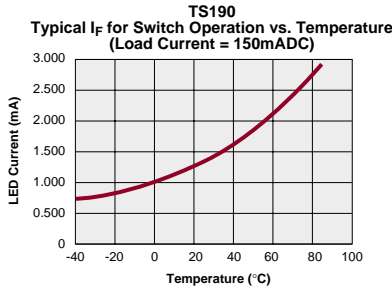
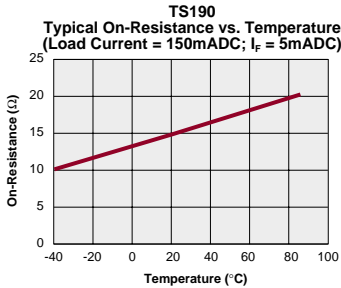
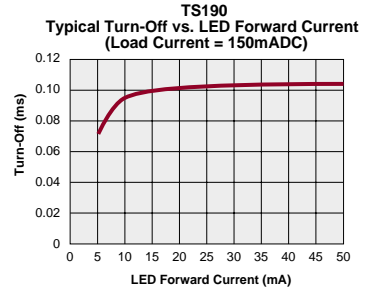
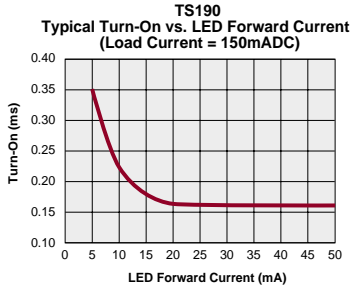
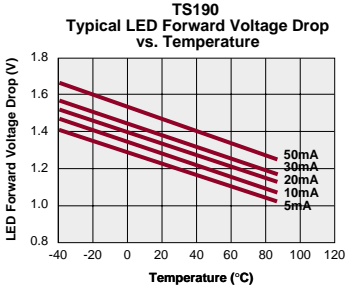

PERFORMANCE DATA

TS190L
Typical LED Forward Voltage Drop
(N=50 Ambient Temperature = 25°C; I_F = 5mADC)

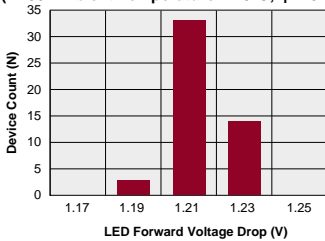

TS190L
Typical On-Resistance Distribution
(N=50 Ambient Temperature = 25°C)
(Load Current = 150mADC; I_F = 5mADC)

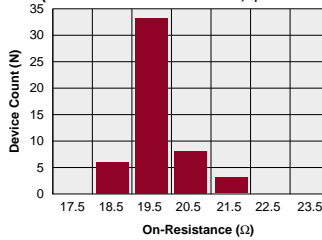

TS190L
Typical Blocking Voltage Distribution
(N=50 Ambient Temperature = 25°C)

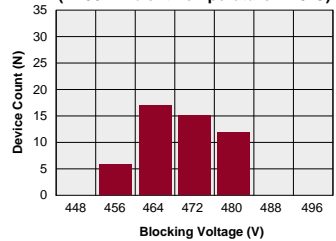

TS190L
Typical I_F for Switch Operation
(N=50 Ambient Temperature = 25°C)
(Load Current = 150mADC)

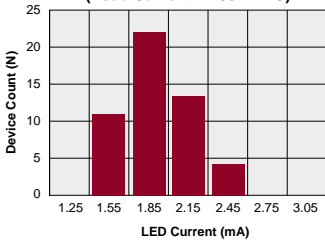

TS190L
Typical I_F for Switch Dropout
(N=50 Ambient Temperature = 25°C;
Load Current = 150mADC)

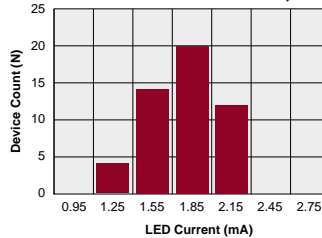

TS190L
Typical Turn-On Time
(N=50 Ambient Temperature = 25°C)
(Load Current = 150mADC; I_F = 5mADC)

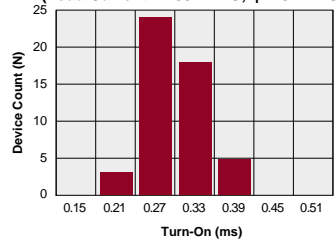

TS190L
Typical Turn-Off Time
(N=50 Ambient Temperature = 25°C)
(Load Current = 150mADC; I_F = 5mADC)

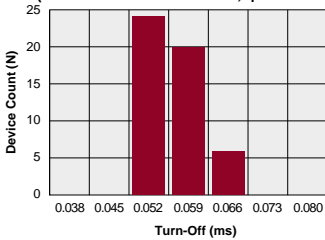

TS190L
Typical Load Current vs. Temperature

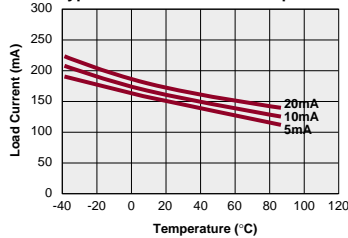

TS190L
Typical Leakage vs. Temperature
(Measured across Pins 7 & 8)

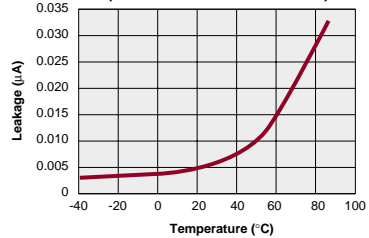

TS190L
Typical Blocking Voltage vs. Temperature

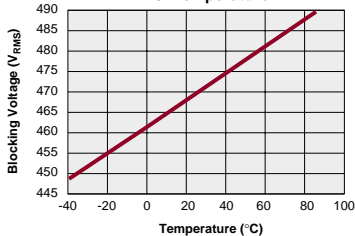

TS190L
Typical Turn-On vs. Temperature
(Load Current = 150mADC)

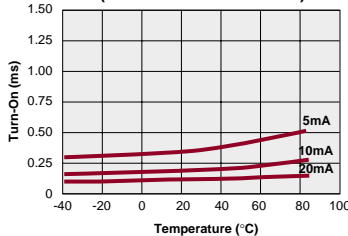

TS190L
Typical Turn-Off vs. Temperature
(Load Current = 150mADC)

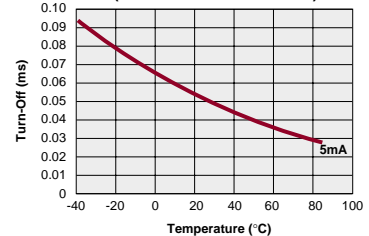

PERFORMANCE DATA

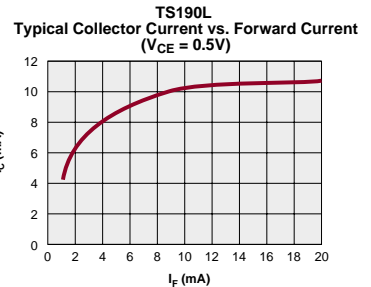
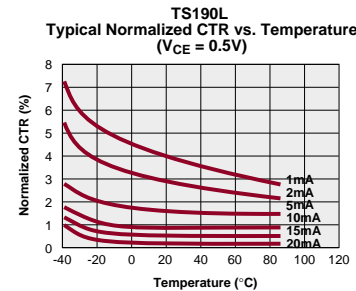
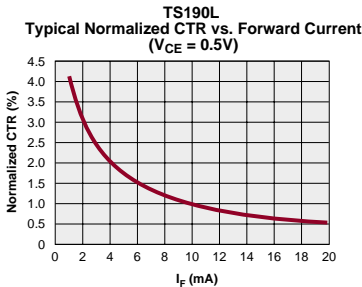
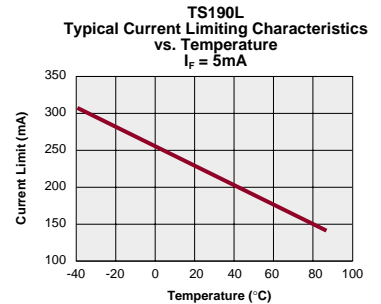
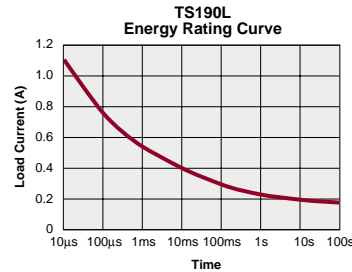
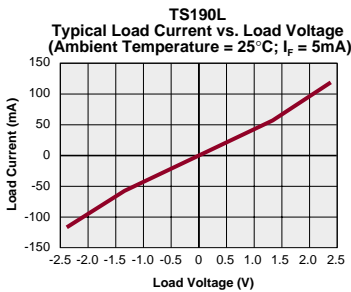
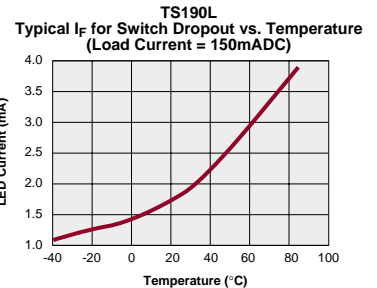
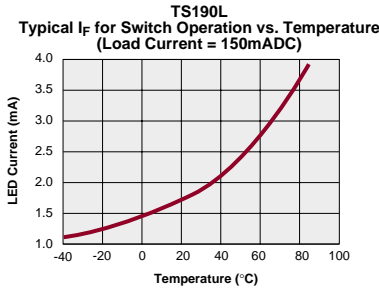
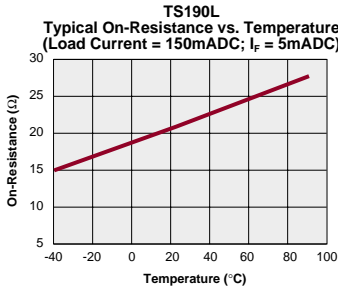
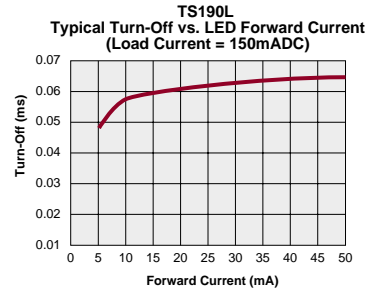
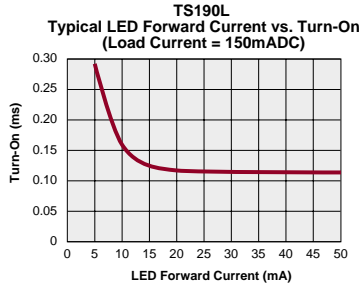
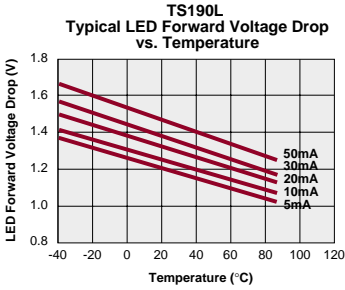

Multifunction Integrated Products



CP Clare's multifunction integrated products combine different versions of CP Clare's core technologies in a sixteen pin SOIC package. Multifunction Integrated Switches (IAA, IAB, IBB, IAD) expand on the "TS" technology to provide an additional function for telecom designers. The ITC provides the major functions of a data access arrangement (DAA) in the 16 pin package to further consolidate PCMCIA modem designs. With all these different offerings and combinations, it is easy to see the "Clare" choice when looking for ideas in PCMCIA design.

Multifunction Integrated Products

Part Number	ITC117	ITC135	ITC137	IAA110P	IAB110P	IBB110P	IAD110	IAD112N	IAA170P	IAD170P	PLCA110	Units
Package Type	16 Pin SOIC	16 Pin SOIC	16 Pin SOIC	16 Pin SOIC	16 Pin SOIC	16 Pin SOIC	16 Pin SOIC	16 Pin SOICN	16 Pin SOIC	16 Pin SOIC	8 Pin DIP	-
Contact Form	1-Form-A	1-Form-A	1-Form-A	2A/1 Opto	1A/1B/1 Opto	2B/1 Opto	1A/2 Opto	1A/2 Opto	2A/1 Opto	1A/2 Opto	1-Form-A/ Surge Arrester	-
<i>Relay Portion</i>												
Load Voltage (Peak)	350	350	350	350	350	350	350	350	350	350	350	V
Load Current (Continuous)	120	120	120	100	100	100	100	120	100	100	120	mA
On-Resistance @ Rated Load Current	15	15	15	35	35	35	35	20	50	50	35	Ω
Input Control Current (I_c)	5	5	5	5	5	5	5	5	5	5	2	mA
<i>Detector Portion</i>												
Current Transfer Ratio (Typ)	33	33	33	33	33	33	33	33	33	33	33	%

ORDERING INFORMATION

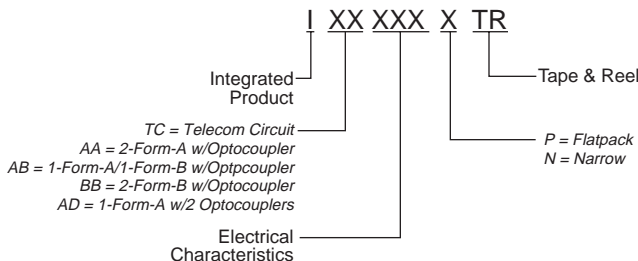



DESCRIPTION

The Integrated Telecom Circuit series combines a 1-Form-A solid state relay, bridge rectifier, Darlington transistor, optocoupler and zener diodes in one package for all your telecom applications.

FEATURES

- Small 16 Pin SOIC Package (PCMCIA Compatible)
- Board Space and Cost Savings
- 2mW Hookswitch Drive Power (Logic Compatible)
- No Moving Parts
- 3750V_{RMS} Input/Output Isolation
- FCC Compatible Part 68
- Full-Wave Bridge Rectifier
- Darlington Transistor for Electronic Inductor “Dry” Circuits
- Current Detector for Ring Signal or Loop Current Detect
- Tape & Reel Versions Available
- JEDEC Standard Pin Out

APPLICATIONS

- Data/Fax Modem
- Voice Mail Systems
- Telephone Sets
- Computer Telephony Integration
- Cable TV Modems

RATINGS (@ 25° C)

Parameter	Min	Typ	Max	Units
Total Package Dissipation	-	-	1 ¹	W
Isolation Voltage				
Input to Output	3750	-	-	V _{RMS}
Operational Temperature	-40	-	+85	°C
Storage Temperature	-40	-	+125	°C
Soldering Temperature (10 Seconds Max.)	-	-	+220	°C

APPROVALS

- UL Recognized: File Number E76270
- CSA Certified: File Number LR 43639-12
- BSI Certified:
 - BS EN 60950:1992 (BS7002:1992)
Certificate #:7969
 - BS EN 41003:1993
Certificate #:7969

OPTIONS / SUFFIXES

- TR: Tape & Reel

¹ Above 25° derate linearly 8.33mw/°C
 Total Power Dissipation (P_T):

$$P_T = P_{\text{HOOKSWITCH}} + P_{\text{BRIDGE}} + P_{\text{DARLINGTON}} + P_{\text{LED}}$$

$$P_T = (R_{\text{DS(on)}}(I_L)^2) + 2(V_F(I_L) + (V_{\text{CE}})(I_L) + (V_{\text{LED}})(I_F))$$
 WHERE:
 R_{DS(on)} = Maximum relay on resistance
 I_L = Maximum loop current
 V_F = Maximum diode forward voltage
 V_{CE} = Maximum voltage collector to emitter
 V_{LED} = Maximum LED forward voltage
 I_F = Maximum LED current

Note: For Mechanical Dimensions See Pages 396-401

SPECIFICATIONS

PARAMETERS	CONDITIONS	SYMBOL	ITC117P			ITC135P			ITC137P			UNITS
			MIN	TYP	MAX	MIN	TYP	MAX	MIN	TYP	MAX	
Relay Portion (Pins 15,16) Output Characteristics @ 25°C												
Load Voltage, DC or Peak AC	-	V_L	-	-	350	-	-	350	-	-	350	V
Load Current (Continuous)	-	I_L	-	-	120	-	-	120	-	-	120	mA
On-Resistance	$I_L=120\text{mA}$	R_{ON}	-	-	15	-	-	15	-	-	15	Ω
Off-State Leakage Current	$V_L=350, T_J=25^\circ\text{C}$	I_{LEAK}	-	-	1	-	-	1	-	-	1	μA
Switching Speeds												
Turn-On	$I_F=5\text{mA}, V_L=10\text{V}$	T_{ON}	-	-	3	-	-	3	-	-	3	ms
Turn-Off	$I_F=5\text{mA}, V_L=10\text{V}$	T_{OFF}	-	-	3	-	-	3	-	-	3	ms
Output Capacitance	50V, $f=1\text{MHz}$	C_{OUT}	-	25	-	-	25	-	-	25	-	pF
Relay Portion (Pins 2,3) Input Characteristics @ 25°C												
Input Control Current	$I_L=120\text{mA}$	I_F	5	-	50	5	-	50	5	-	50	mA
Input Voltage Drop	$I_F=5\text{mA}$	V_F	0.9	1.2	1.4	0.9	1.2	1.4	0.9	1.2	1.4	V
Reverse Input Voltage	-	V_R	-	-	5	-	-	5	-	-	5	V
Reverse Input Current	$V_R=5\text{V}$	I_R	-	-	10	-	-	10	-	-	10	μA
Detector Portion (Pins 7,8) Output Characteristics @ 25°C												
Phototransistor Blocking Voltage	$I_C=10\mu\text{A}$	BV_{CEO}	20	50	-	20	50	-	20	50	-	V
Phototransistor Dark Current	$V_{CE}=5\text{V}, I_F=0\text{mA}$	I_{CEO}	-	50	500	-	50	500	-	50	500	A
Saturation Voltage	$I_C=2\text{mA}, I_F=16\text{mA}$	V_{SAT}	-	0.3	0.5	-	0.3	0.5	-	0.3	0.5	V
Current Transfer Ratio	$I_F=6\text{mA}, V_{CE}=0.5\text{V}$	CTR	33	400	-	33	400	-	33	400	-	%
Detector Portion (Pins 9,10) Input Characteristics @ 25°C												
Input Control Current	$I_C=2\text{mA}, V_{CE}=0.5\text{V}$	I_F	6	2	100	6	2	100	6	2	100	mA
Input Voltage Drop	$I_F=5\text{mA}$	V_F	0.9	1.2	1.4	0.9	1.2	1.4	0.9	1.2	1.4	V
Input Current (Detector must be off)	$I_C=1\mu\text{A}, V_{CE}=5\text{V}$	I_F	5	25	-	5	25	-	5	25	-	μA

Note: For Mechanical Dimensions See Pages 396-401

SPECIFICATIONS

PARAMETERS	CONDITIONS	SYMBOL	ITC117P			ITC135P			ITC137P			UNITS
			MIN	TYP	MAX	MIN	TYP	MAX	MIN	TYP	MAX	
Bridge Rectifier Electrical Ratings @ 25°C												
Reverse Voltage	-	V_{RD}	-	-	100	-	-	100	-	-	100	V
Forward Drop Voltage	$I_{FD}=120\text{mA}$	V_{FD}	-	-	1.5	-	-	1.5	-	-	1.5	V
Reverse Leakage Current	$T_J=25^\circ\text{C}, V_R=100\text{V}$ $T_J=85^\circ\text{C}$	I_{RD}	-	-	10	-	-	10	-	-	10	μA
			-	-	50	-	-	50	-	-	50	μA
Forward Current (Continuous)		I_{FD}	-	-	140	-	-	140	-	-	140	mA
Forward Current (Peak)	$t=10\text{mS}$	I_{FD}	-	-	0.5	-	-	0.5	-	-	0.5	A
Darlington Electrical Ratings @ 25°C												
Collector-Emitter Voltage	$I_c=10\text{mA DC}, I_b=0$	V_{CEO}	40	-	-	40	-	-	40	-	-	V
Collector-Current Continuous	$V_{CE}=3.5\text{V}$	I_C	-	-	120	-	-	120	-	-	120	mA
Power Dissipation @ 25°C	-	P_d	-	-	500	-	-	500	-	-	500	mW
Off-State Collector Emitter Leakage Current	$V_{CE}=10\text{V}; I_b=0\text{mA}$	I_{CEX}	-	-	1	-	-	1	-	-	1	μA
DC Current Gain	$I_c=120\text{mA},$ $V_{CE}=10\text{VDC}$	h_{FE}	10,000	-	-	10,000	-	-	10,000	-	-	
Saturation Voltage	$I_c=120\text{mA}$	$V_{CE(SAT)}$	-	-	1.5	-	-	1.5	-	-	1.5	V
Total Harmonic Distortion	$f_o=300\text{Hz @ -10dBm}$ $I_c=40\text{mA}$	-	-	-	-80	-	-	-80	-	-	-80	dB
Zener Characteristics @ 25°C												
Zener Voltage (Between pins 4+5 and 6+5)	$I_{ZI}=20\text{mA}$	V_z	-	-	-	-	4.3	-	-	4.3	-	V
Zener Voltage (Between pins 12+11)	$I_{ZI}=20\text{mA}$	V_z	-	-	-	-	15	-	-	15	-	V
Input to Output Capacitance	-	$C_{I/O}$	-	3	-	-	3	-	-	3	-	pF
Input to Output Isolation	-	$V_{I/O}$	3750	-	-	3750	-	-	3750	-	-	V_{RMS}

Note: For Mechanical Dimensions See Pages 396-401

PACKAGE PINOUT

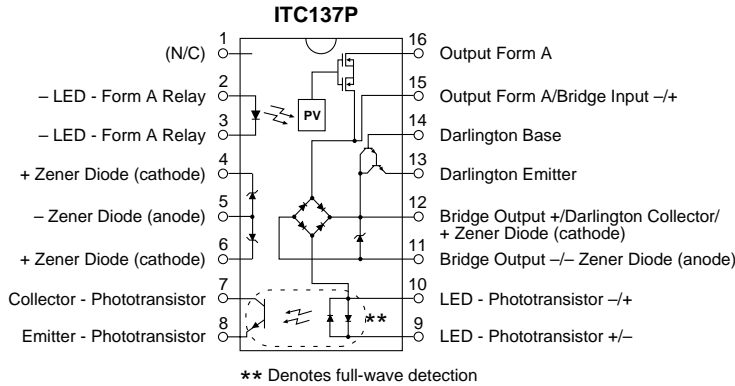
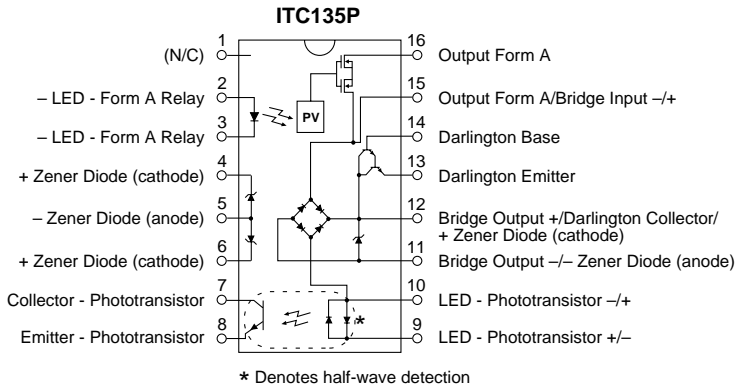
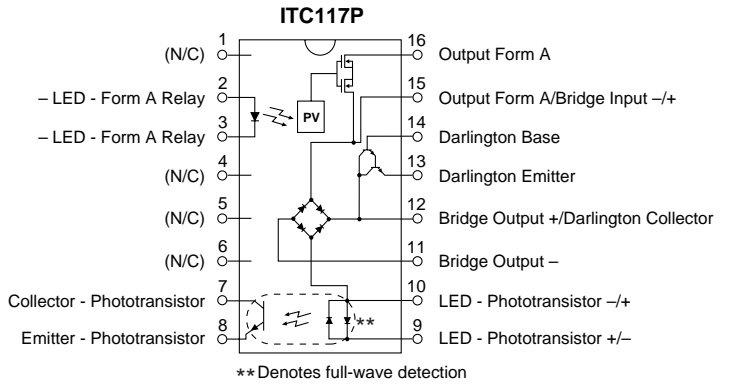

Note: For Mechanical Dimensions See Pages 396-401

EXAMPLE CIRCUIT

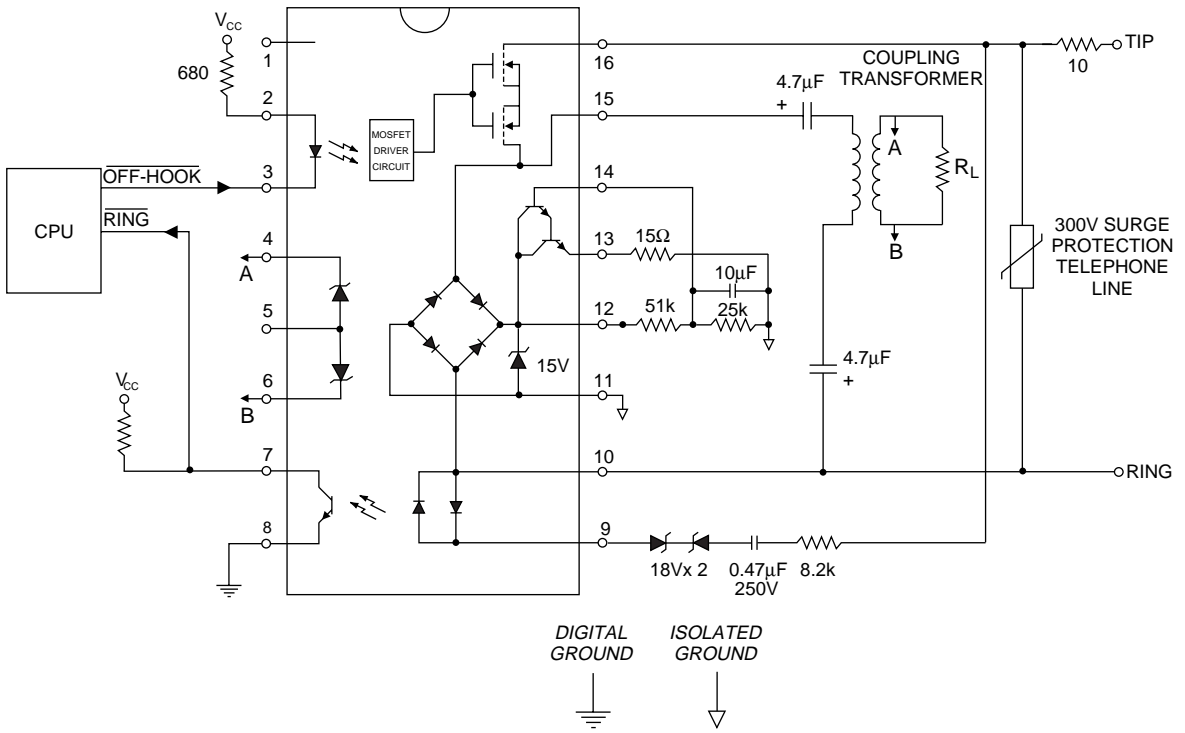

Note: For Mechanical Dimensions See Pages 396-401

PERFORMANCE DATA

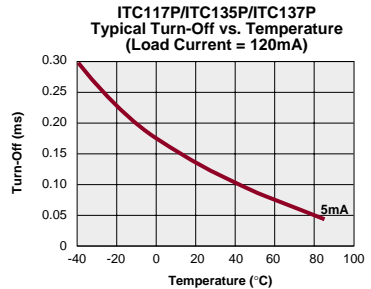
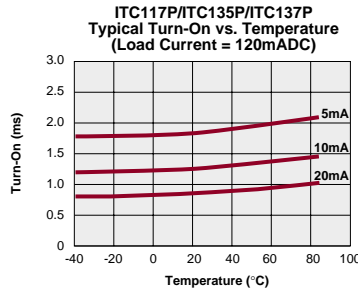
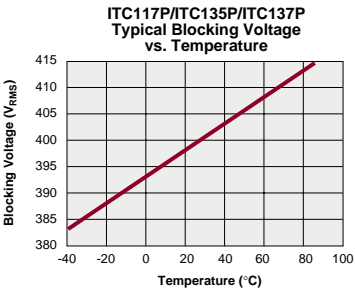
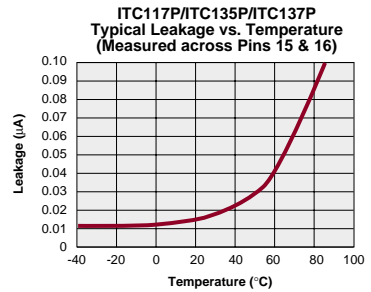
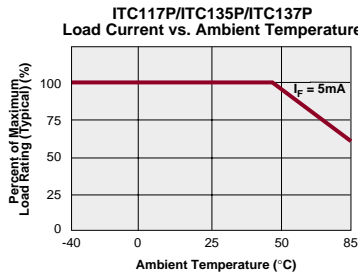
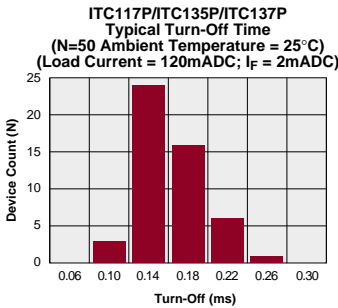
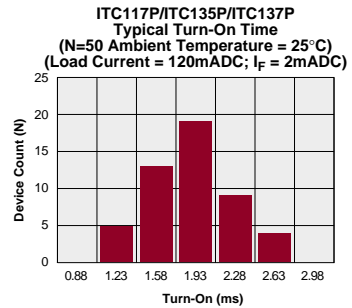
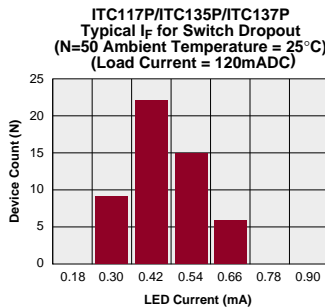
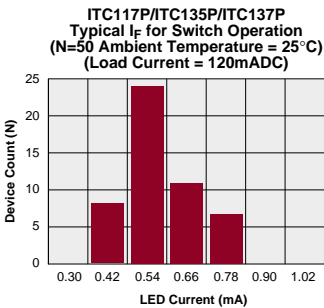
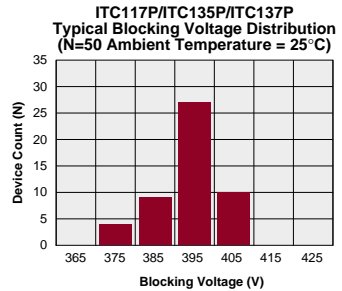
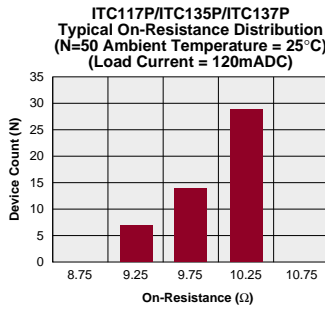
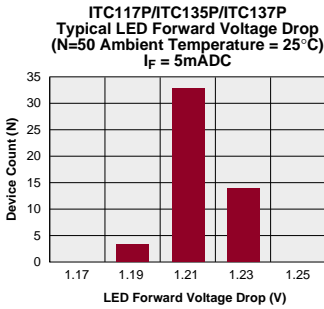

PERFORMANCE DATA

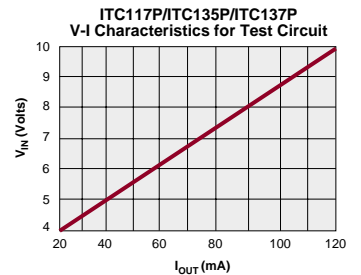
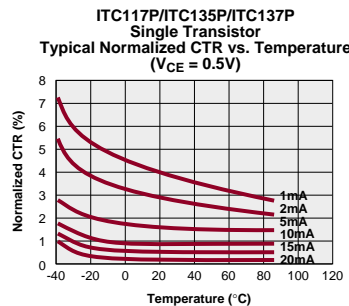
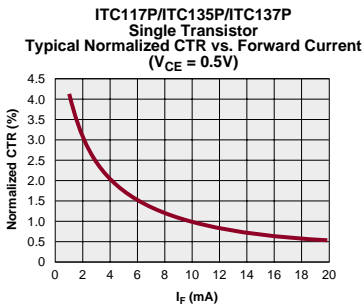
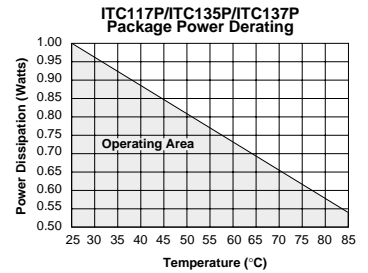
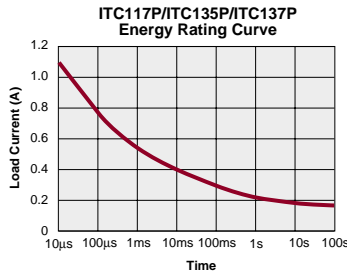
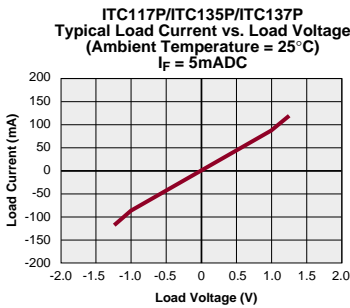
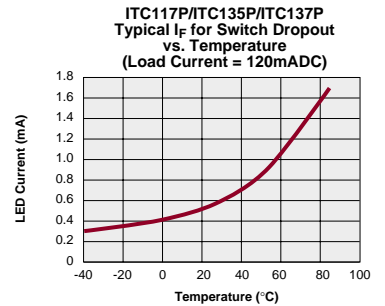
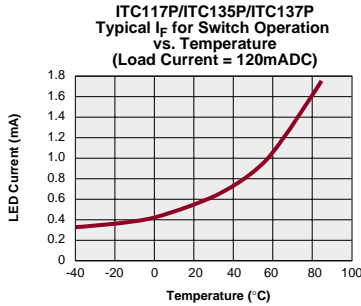
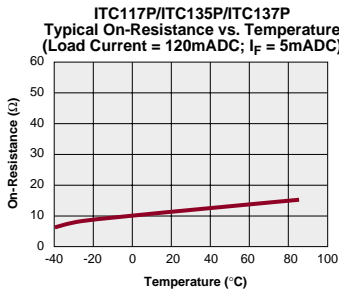
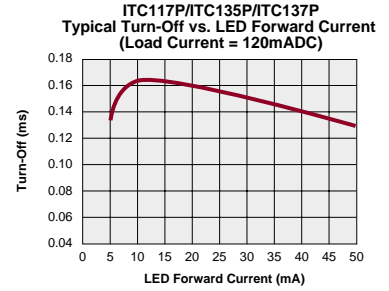
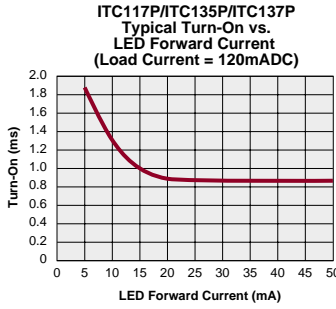
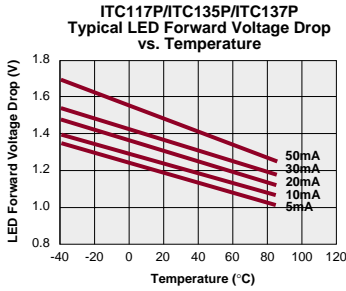

PERFORMANCE DATA

ITC117P/ITC135P/ITC137P
Single Transistor
Typical Collector Current vs. Forward Current
($V_{CE} = 0.5V$)

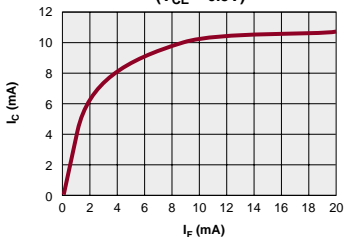

ITC117P/ITC135P/ITC137P
Darlington Transistor
Typical Collector Current vs. Forward Current
($V_{CE} = 0.5V$)

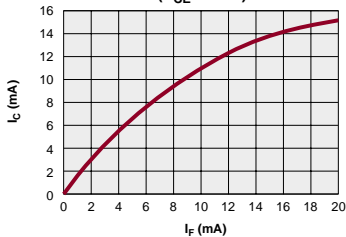

ITC117P/ITC135P/ITC137P
Darlington Transistor
Typical Normalized CTR vs. Forward Current
($V_{CE} = 0.8V$)

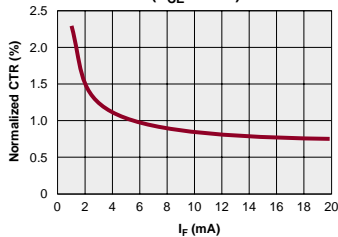

ITC117P/ITC135P/ITC137P
Darlington Transistor
Typical Normalized CTR vs. Temperature
($V_{CE} = 0.8V$)

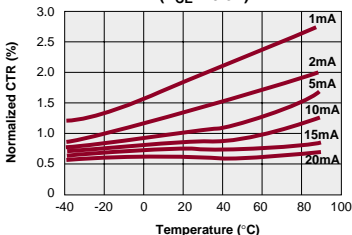

ITC117P/ITC135P/ITC137P
Typical Transfer Characteristics of
Single Transistor Detector

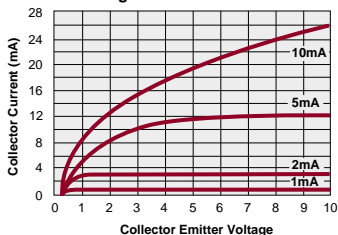

ITC117P/ITC135P/ITC137P
Typical Transfer Characteristics of
Darlington Transistor

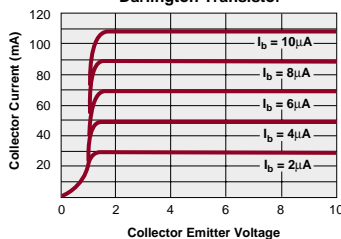

IAA110P/IBB110P/IAB110P/IAD110P/IAD112N*



DESCRIPTION

The IAA110P, IAB110P, IBB110P, IAD110P and IAD112N multifunction switches combine a 350V, 120mA, 35Ω relay(s) and optocouplers in one package. Various combinations are available depending on the part number.

FEATURES

- Three Functions in One Package
- Small 16 Pin SOIC Package (PCMCIA Compatible)
- Bi-Directional Current Sensing
- Bi-Directional Current Switching
- Replaces up to Three or Four Components
- 3750V_{RMS} Input/Output Isolation
- FCC Compatible
- No EMI/RFI Generation
- Machine Insertable, Wave Solderable
- Tape & Reel Versions Available

APPLICATIONS

- Telecommunications
 - Telecom Switching
 - Tip/Ring Circuits
 - Modem Switching (Laptop, Notebook, Pocket Size)
 - Hookswitch
 - Dial Pulsing
 - Ground Start
 - Ringer Injection
- Instrumentation
 - Multiplexers
 - Data Acquisition
 - Electronic Switching
 - I/O Subsystems
 - Meters (Watt-Hour, Water, Gas)
- Medical Equipment-Patient/Equipment Isolation
- Security
- Aerospace
- Industrial Controls

APPROVALS

- UL Recognized: File Number E76270
- CSA Certified: File Number LR 43639-12
- VDE Compatible
- BSI Certified:
 - BS EN 60950:1992 (BS7002:1992) Certificate #:7969
 - BS EN 41003:1993 Certificate #:7969
- UL/CSA & BSI: Pending – Narrow

RATINGS (@ 25° C)

Parameter	Min	Typ	Max	Units
Total Package Dissipation	-	-	1 ¹	W
Isolation Voltage				
Input to Output	3750	-	-	V _{RMS}
Operational Temperature	-40	-	+85	°C
Storage Temperature	-40	-	+125	°C
Soldering Temperature (10 Seconds Max.)	-	-	+220	°C

¹ Above 25° derate linearly 1.67mW/°C

OPTIONS / SUFFIXES

- N: Narrow Package
- TR: Tape & Reel
- * Call CP Clare for Electrical Characteristics

Switching Characteristics of Normally Closed (Form B) Devices

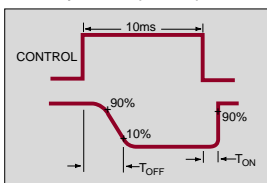

Switching Characteristics of Normally Open (Form A) Devices

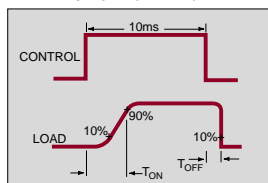

Note: For Mechanical Dimensions See Pages 396-401

SPECIFICATIONS

PARAMETERS	CONDITIONS	SYMBOL	MIN	TYP	MAX	UNITS
Relay Portion Output Characteristics @ 25°C						
Load Voltage (Peak)	$I_L = 1\mu\text{A}$	V_L	-	-	350	V
Load Current (Continuous)	-	I_L	-	-	100	mA
Peak Load Current	10ms	I_{LPK}	-	-	350	mA
On-Resistance	$I_L = 100\text{mA}$	R_{ON}	-	-	35	Ω
Off-State Leakage Current	$V_L = 350\text{V}; T_J = 25^\circ\text{C}$	I_{LEAK}	-	-	1	μA
Switching Speeds						
Turn-On	$I_F = 5\text{mA}, V_L = 10\text{V}$	T_{ON}	-	-	3	ms
Turn-Off	$I_F = 5\text{mA}, V_L = 10\text{V}$	T_{OFF}	-	-	3	ms
Output Capacitance	$V_L = 50\text{V}, f = 1\text{MHz}$	-	-	25	-	pF
Relay Portion Input Characteristics @ 25°C						
Input Control Current	$I_L = 100\text{mA}$	I_F	5	-	50	mA
Input Dropout Current	$I_L = 1\text{mA}$	I_F	0.4	-	-	mA
Input Voltage Drop	$I_F = 5\text{mA}$	V_F	0.9	1.2	1.4	V
Reverse Input Voltage	-	V_R	-	-	5	V
Reverse Input Current	$V_R = 5\text{V}$	I_R	-	-	10	μA
Detector Portion Output Characteristics @ 25°C						
Phototransistor Blocking Voltage	$I_C = 10\mu\text{A}$	BV_{CEO}	20	50	-	V
Phototransistor Dark Current	$V_{CE} = 5\text{V}, I_F = 0\text{mA}$	I_{CEO}	-	50	500	nA
Saturation Voltage	$I_C = 2\text{mA}, I_F = 16\text{mA}$	V_{SAT}	-	0.3	0.5	V
Current Transfer Ratio	$I_F = 6\text{mA}, V_{CE} = 0.5\text{V}$	CTR	33	-	-	%
Detector Portion Input Characteristics @ 25°C						
Input Control Current	$I_C = 2\text{mA}, V_{CE} = 0.5\text{V}$	I_F	6	2	-	mA
Input Voltage Drop	$I_F = 5\text{mA}$	I_{CEO}	0.9	1.2	1.4	V
Input Current (Detector must be off)	$I_C = 1\mu\text{A}, V_{CE} = 5\text{V}$	-	5	25	-	μA
Input to Output Capacitance	$V_L = 50\text{V}, f = 1\text{MHz}$	$C_{I/O}$	-	3	-	pF
Input to Output Isolation	-	$V_{I/O}$	3750	-	-	V_{RMS}

Note: For Mechanical Dimensions See Pages 396-401

IAA110P/IBB110P/IAB110P/IAD110P/IAD112N*

EQUIVALENT CIRCUITS

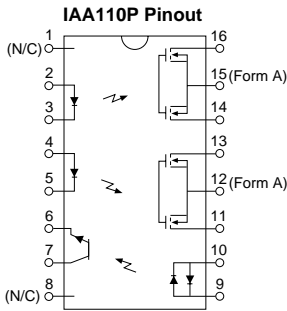

- 1. (N/C)
- 2. + LED - Form A Relay #1
- 3. - LED - Form A Relay #1
- 4. + LED - Form A Relay #2
- 5. - LED - Form A Relay #2
- 6. Emitter - Phototransistor
- 7. Collector - Phototransistor
- 8. (N/C)
- 9. LED - Phototransistor +/-
- 10. LED - Phototransistor -/+
- 11. Output - Form A Relay #2
- 12. Common Source Relay #2
- 13. Output - Form A Relay #2
- 14. Output - Form A Relay #1
- 15. Common Source Relay #1
- 16. Output - Form A Relay #1

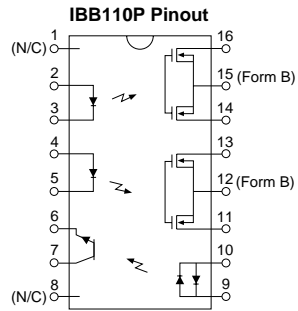

- 1. (N/C)
- 2. + LED - Form B Relay #1
- 3. - LED - Form B Relay #1
- 4. + LED - Form B Relay #2
- 5. - LED - Form B Relay #2
- 6. Emitter - Phototransistor
- 7. Collector - Phototransistor
- 8. (N/C)
- 9. LED - Phototransistor +/-
- 10. LED - Phototransistor -/+
- 11. Output - Form B Relay #2
- 12. Common Source Relay #2
- 13. Output - Form B Relay #2
- 14. Output - Form B Relay #1
- 15. Common Source Relay #1
- 16. Output - Form B Relay #1

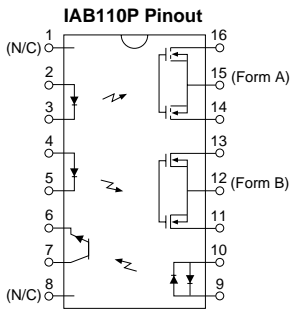

- 1. (N/C)
- 2. + LED - Form A Relay #1
- 3. - LED - Form A Relay #1
- 4. + LED - Form B Relay #2
- 5. - LED - Form B Relay #2
- 6. Emitter - Phototransistor
- 7. Collector - Phototransistor
- 8. (N/C)
- 9. LED - Phototransistor +/-
- 10. LED - Phototransistor -/+
- 11. Output - Form B Relay #2
- 12. Common Source Relay #2
- 13. Output - Form B Relay #2
- 14. Output - Form A Relay #1
- 15. Common Source Relay #1
- 16. Output - Form A Relay #1

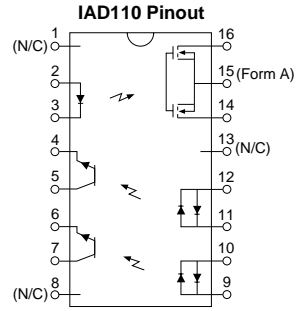

- 1. (N/C)
- 2. + LED - Relay Input
- 3. - LED - Relay Input
- 4. Emitter - Phototransistor #1
- 5. Collector - Phototransistor #1
- 6. Emitter - Phototransistor #2
- 7. Collector - Phototransistor #2
- 8. (N/C)
- 9. LED - Phototransistor +/- #2
- 10. LED - Phototransistor -/+ #2
- 11. LED - Phototransistor +/- #1
- 12. LED - Phototransistor -/+ #1
- 13. (N/C)
- 14. Output - Relay
- 15. Common - Relay
- 16. Output - Relay

Note: For Mechanical Dimensions See Pages 396-401

PERFORMANCE DATA

IAA110P
Typical LED Forward Voltage Drop
(N=50 Ambient Temperature = 25°C; I_F = 5mADC)

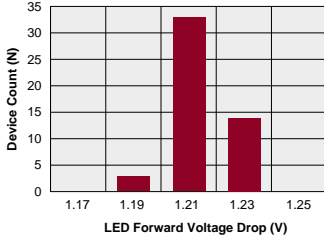

IAA110P
Typical On-Resistance Distribution
(N=50 Ambient Temperature = 25°C)
(Load Current = 100mADC, I_F = 5mADC)

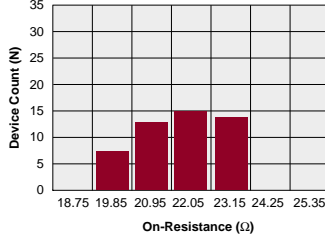

IAA110P
Typical Blocking Voltage Distribution
(N=50 Ambient Temperature = 25°C)

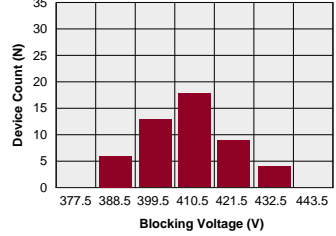

IAA110P
Typical I_F for Switch Operation
(N=50 Ambient Temperature = 25°C)
(Load Current = 100mADC)

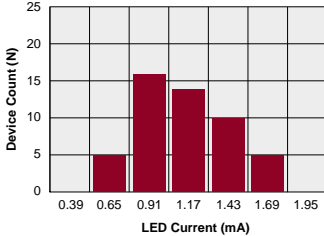

IAA110P
Typical I_F for Switch Dropout
(N=50 Ambient Temperature = 25°C)
(Load Current = 100mADC)

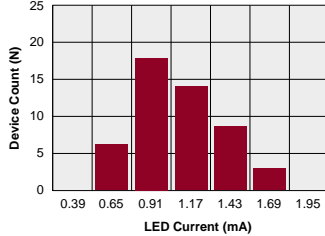

IAA110P
Typical Turn-On Time
(N=50 Ambient Temperature = 25°C)
(Load Current = 100mADC; I_F = 5mADC)

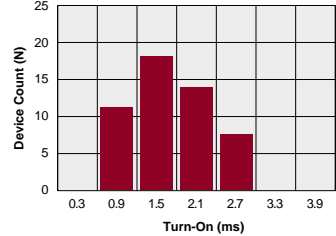

IAA110P
Typical Turn-Off Time
(N=50 Ambient Temperature = 25°C)
(Load Current = 100mADC; I_F = 5mADC)

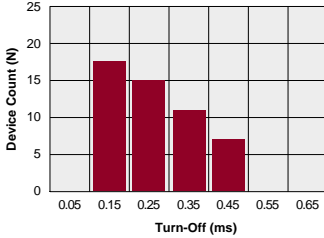

IAA110P
Typical Load Current vs. Temperature

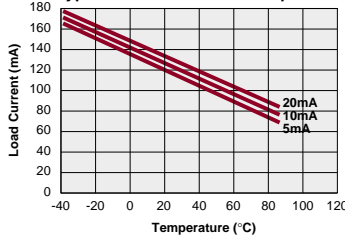

IAA110P
Typical Leakage vs. Temperature
(Measured across Pins 14 & 16 or 11 & 13)

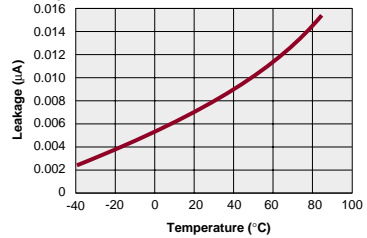

IAA110P
Typical Blocking Voltage vs. Temperature

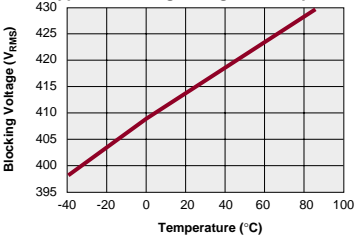

IAA110P
Typical Turn-On vs. Temperature
(Load Current = 100mADC)

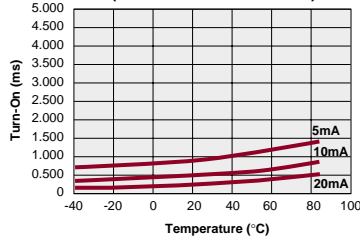

IAA110P
Typical Turn-Off vs. Temperature
(Load Current = 100mADC)

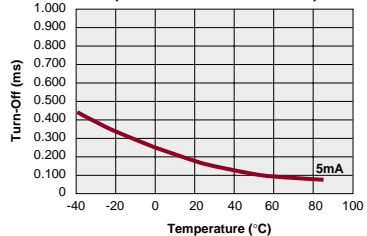

IAA110P/IBB110P/IAB110P/IAD110P/IAD112N*

PERFORMANCE DATA

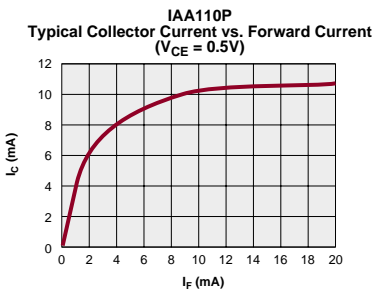
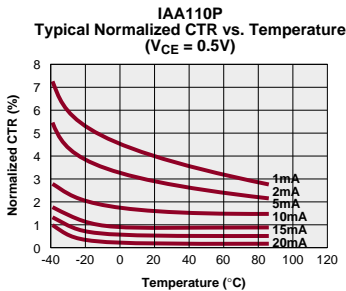
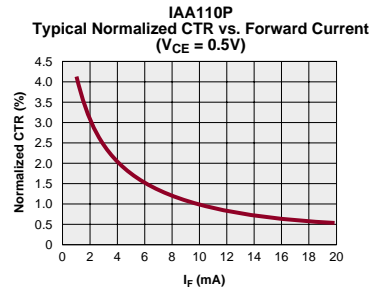
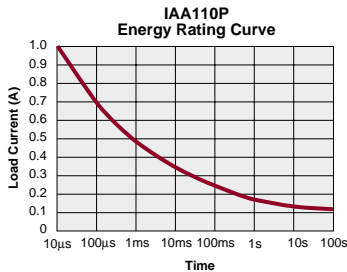
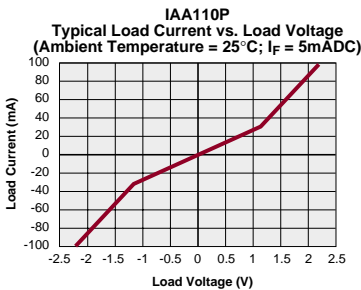
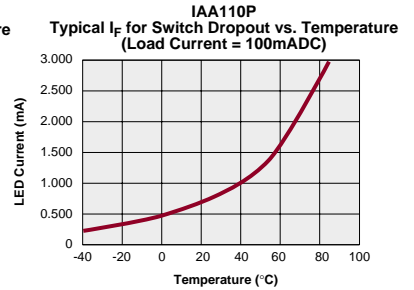
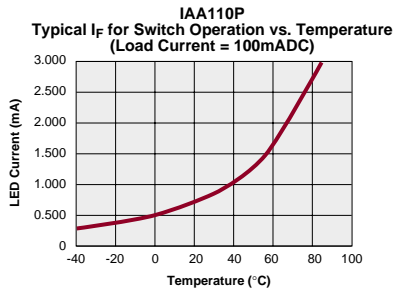
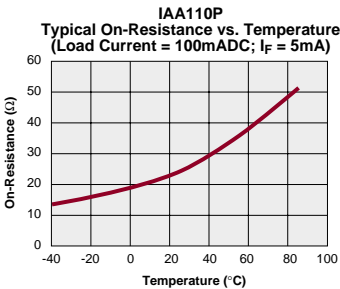
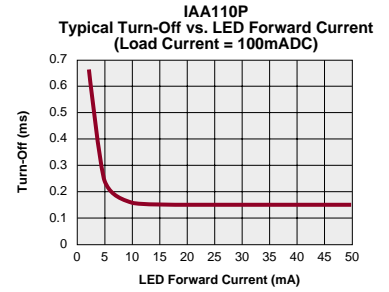
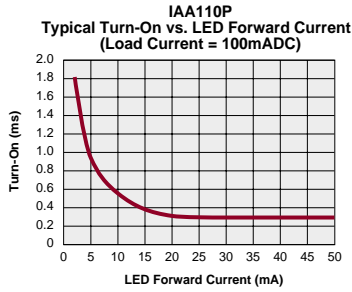
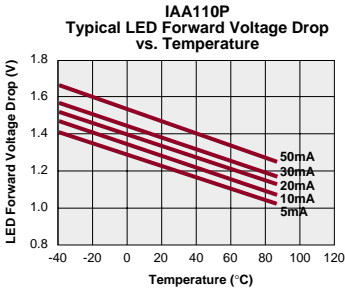

PERFORMANCE DATA

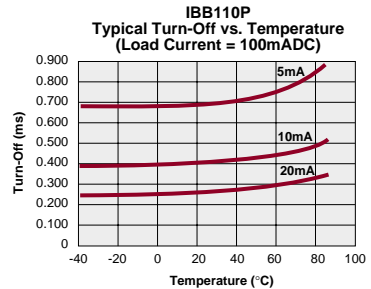
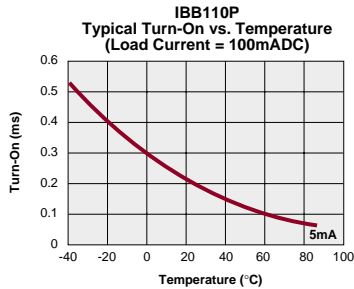
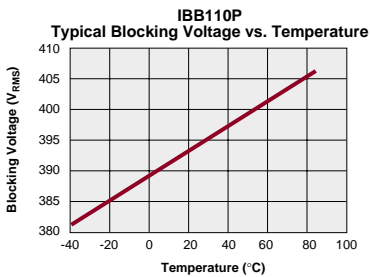
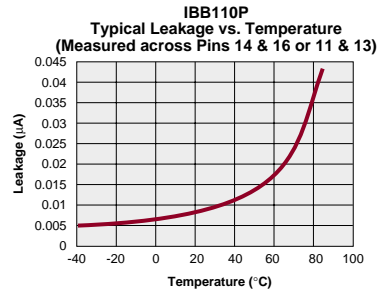
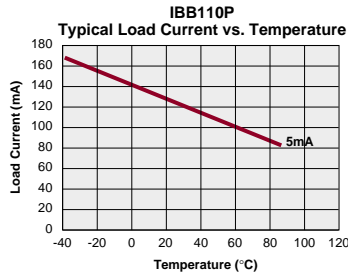
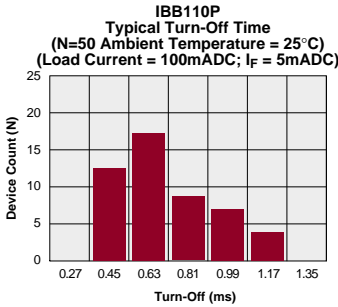
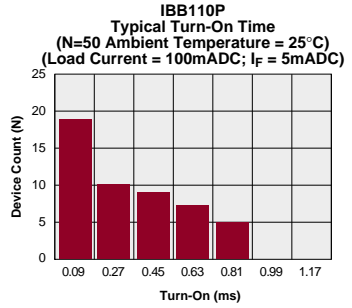
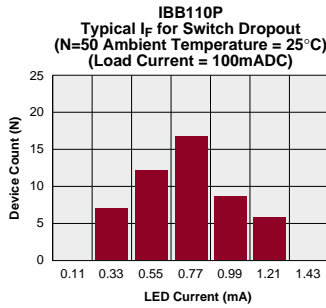
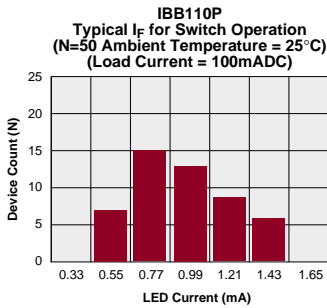
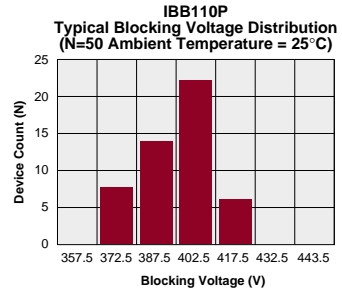
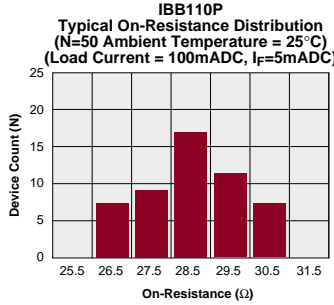
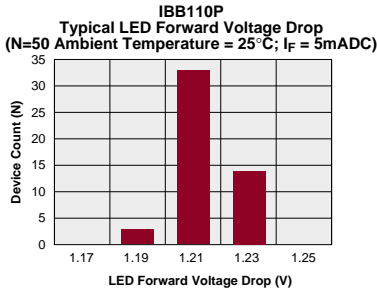

IAA110P/IBB110P/IAB110P/IAD110P/IAD112N*

PERFORMANCE DATA

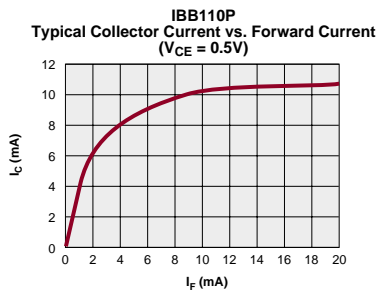
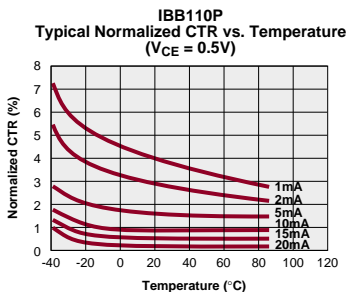
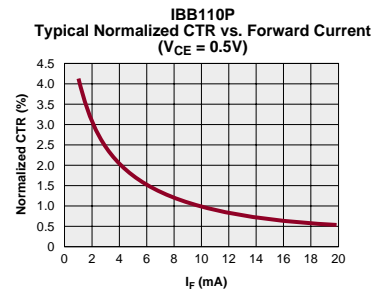
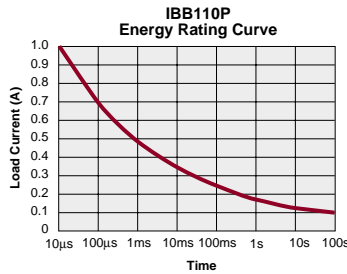
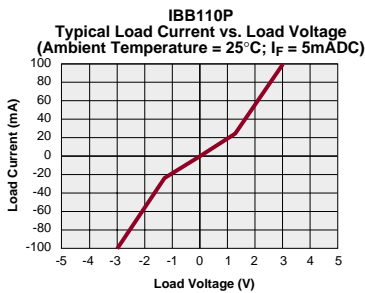
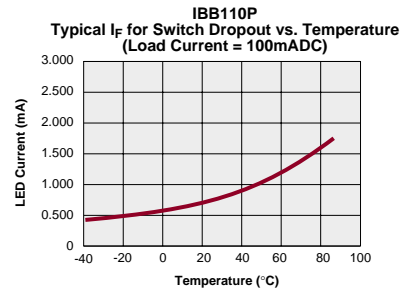
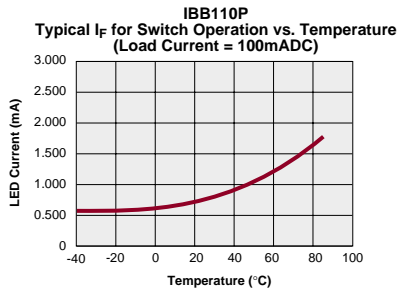
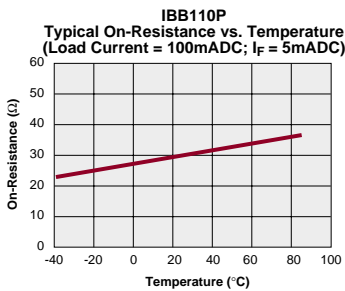
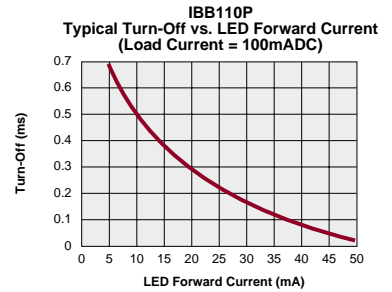
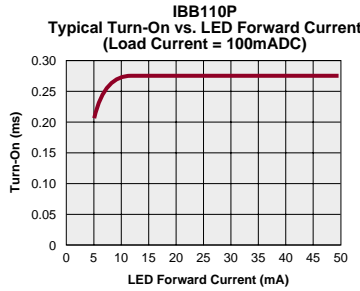
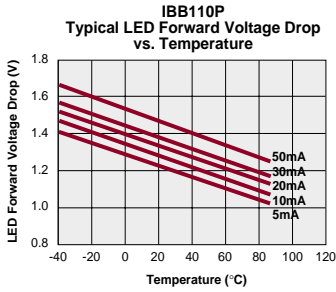

PERFORMANCE DATA

IAB110P
Typical LED Forward Voltage Drop
(N=50 Ambient Temperature = 25°C; I_F = 5mA DC)

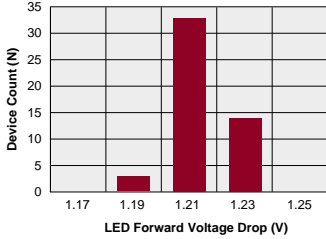

IAB110P - FormA
Typical On-Resistance Distribution
(N=50 Ambient Temperature = 25°C)
(Load Current = 100mA DC, I_F = 5mA DC)

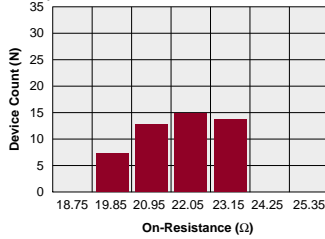

IAB110P - FormB
Typical On-Resistance Distribution
(N=50 Ambient Temperature = 25°C)
(Load Current = 100mA DC, I_F = 5mA DC)

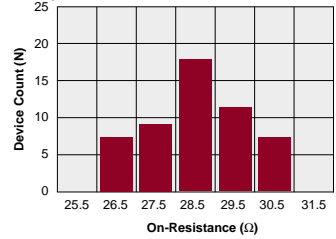

IAB110P - FormA
Typical Blocking Voltage Distribution
(N=50 Ambient Temperature = 25°C)

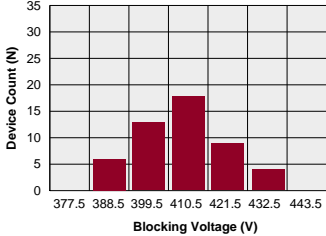

IAB110P - FormB
Typical Blocking Voltage Distribution
(N=50 Ambient Temperature = 25°C)

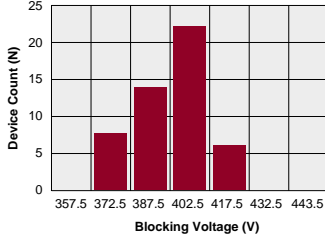

IAB110P - FormA
Typical I_F for Switch Operation
(N=50 Ambient Temperature = 25°C)
(Load Current = 100mA DC)

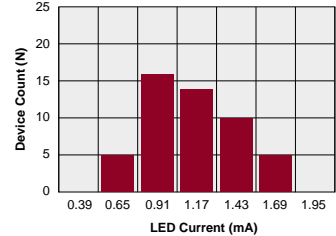

IAB110P - FormB
Typical I_F for Switch Operation
(N=50 Ambient Temperature = 25°C)
(Load Current = 100mA DC)

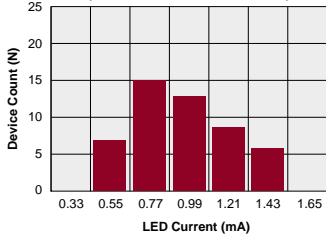

IAB110P - FormA
Typical I_F for Switch Dropout
(N=50 Ambient Temperature = 25°C)
(Load Current = 100mA DC)

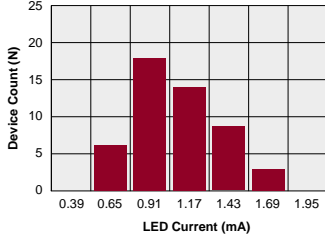

IAB110P - FormB
Typical I_F for Switch Dropout
(N=50 Ambient Temperature = 25°C)
(Load Current = 100mA DC)

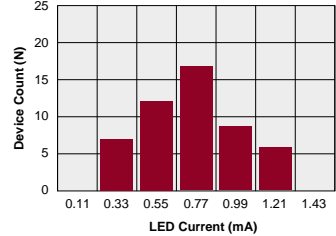

IAB110P - FormA
Typical Turn-On Time
(N=50 Ambient Temperature = 25°C)
(Load Current = 100mA DC; I_F = 5mA DC)

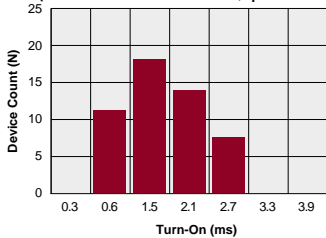

IAB110P - FormB
Typical Turn-On Time
(N=50 Ambient Temperature = 25°C)
(Load Current = 100mA DC; I_F = 5mA DC)

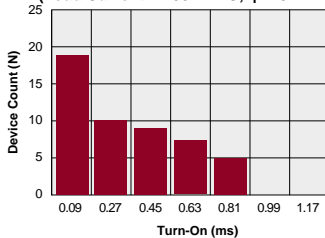

IAB110P - FormA
Typical Turn-Off Time
(N=50 Ambient Temperature = 25°C)
(Load Current = 100mA DC; I_F = 5mA DC)

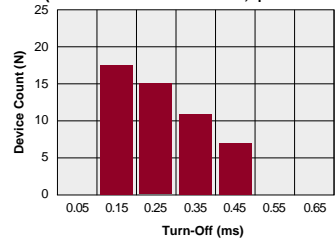

IAA110P/IBB110P/IAB110P/IAD110P/IAD112N*

PERFORMANCE DATA

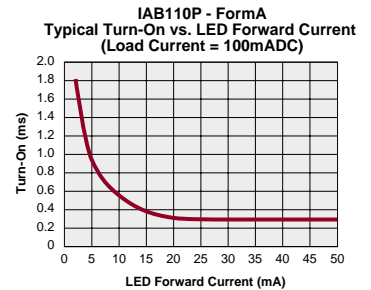
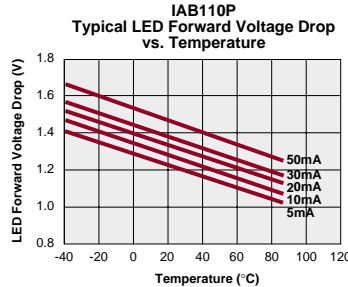
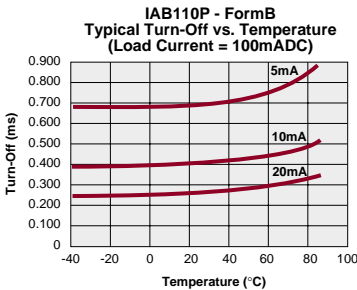
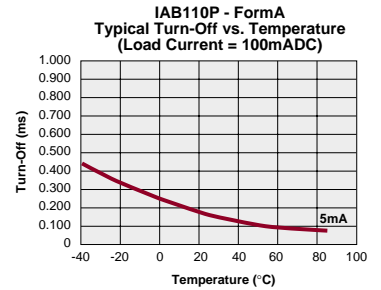
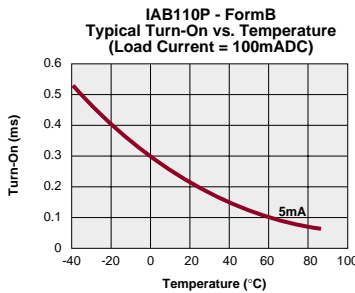
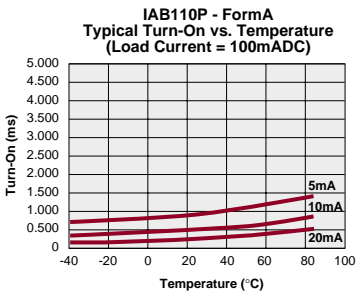
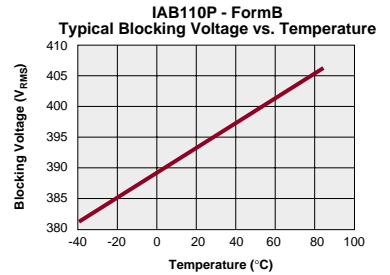
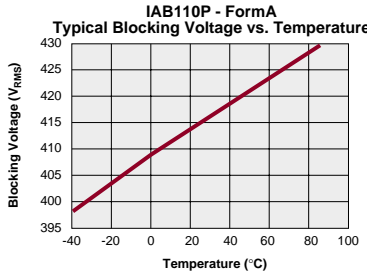
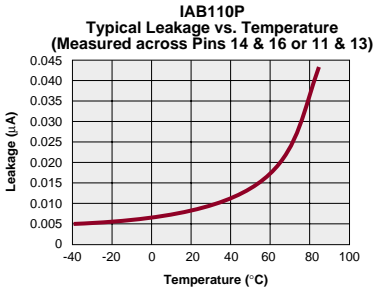
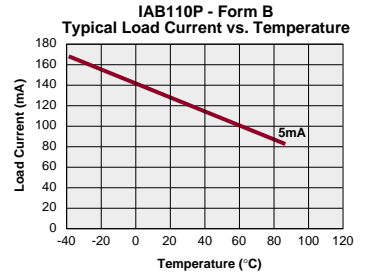
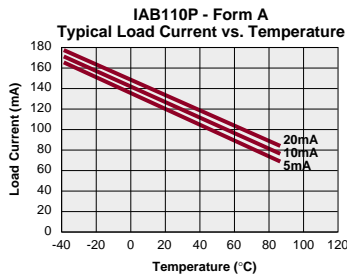
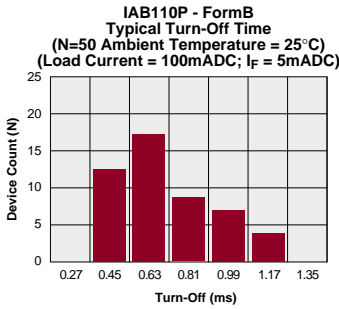

PERFORMANCE DATA

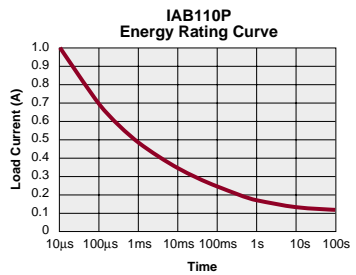
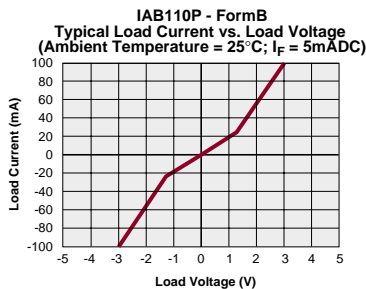
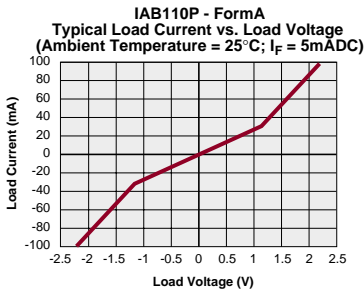
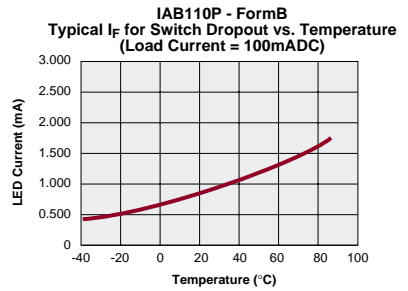
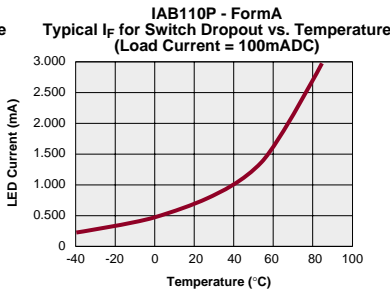
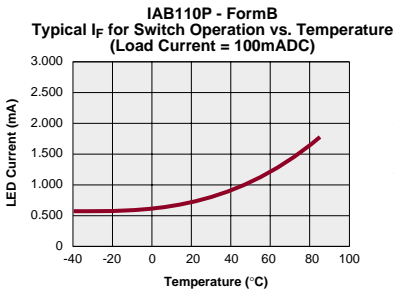
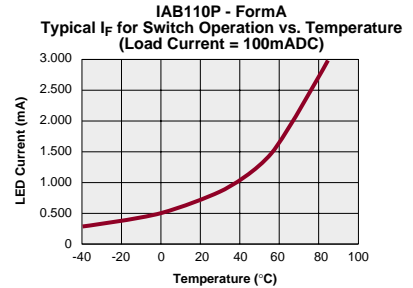
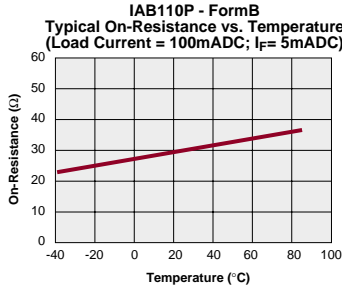
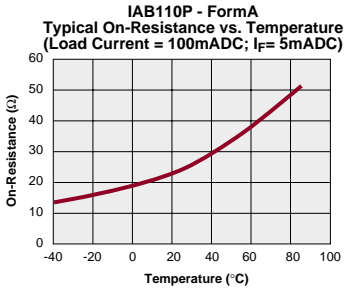
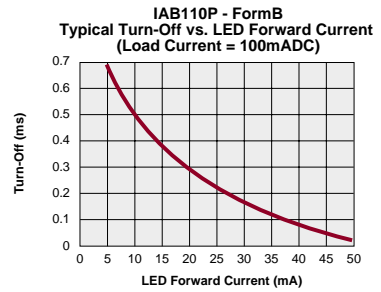
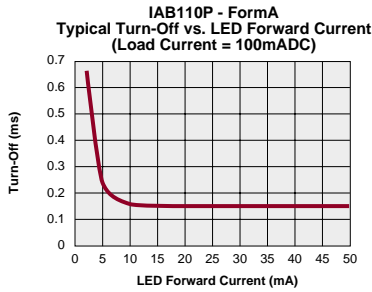
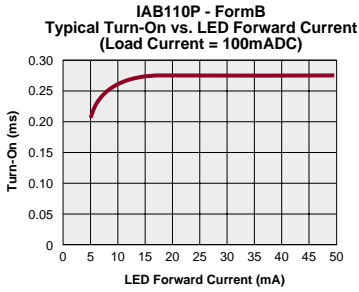

IAA110P/IBB110P/IAB110P/IAD110P/IAD112N*

PERFORMANCE DATA

IAB110P
Typical Normalized CTR vs. Forward Current
($V_{CE} = 0.5V$)

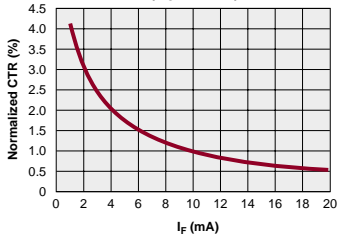

IAB110P
Typical Normalized CTR vs. Temperature
($V_{CE} = 0.5V$)

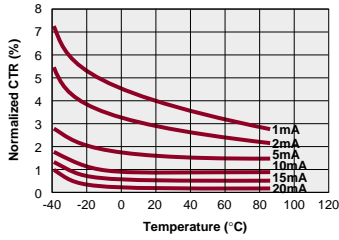

IAB110P
Typical Collector Current vs. Forward Current
($V_{CE} = 0.5V$)

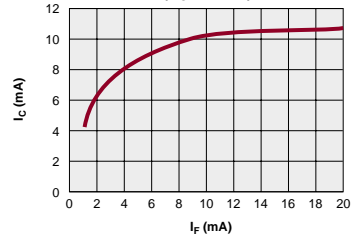

PERFORMANCE DATA

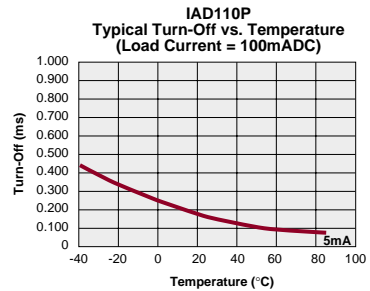
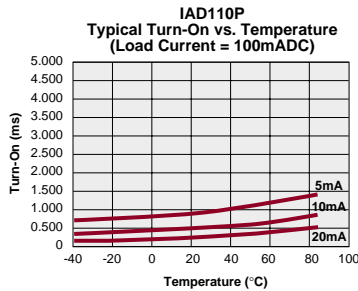
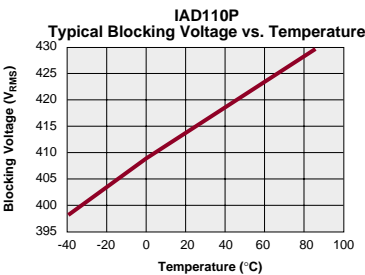
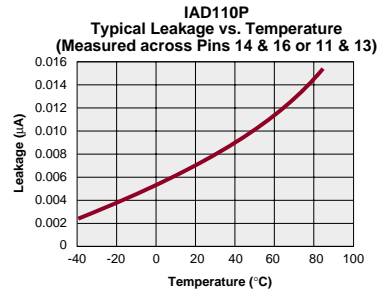
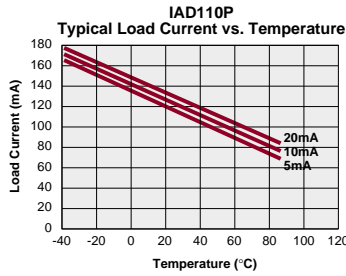
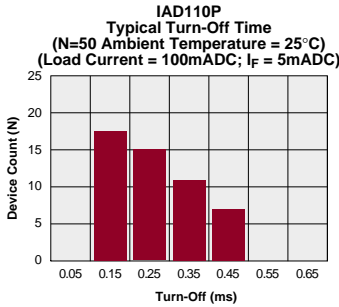
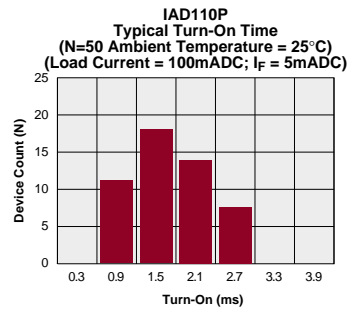
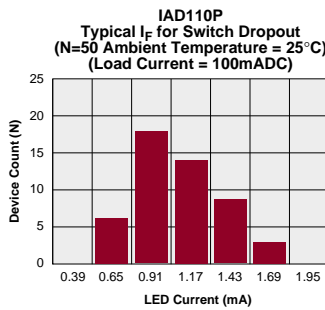
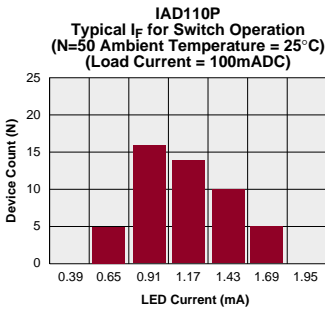
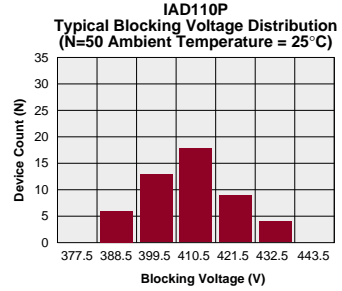
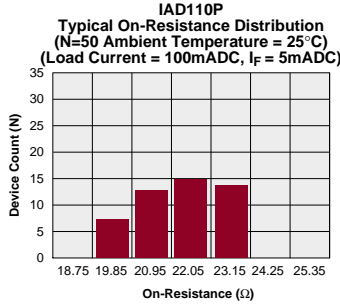
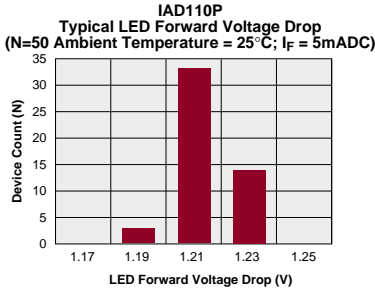

IAA110P/IBB110P/IAB110P/IAD110P/IAD112N*

PERFORMANCE DATA

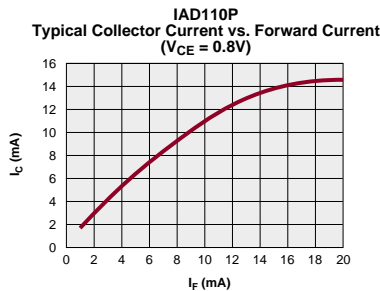
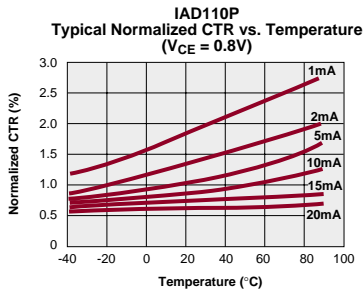
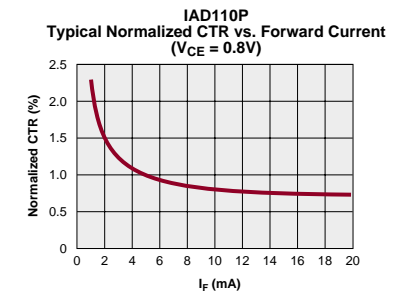
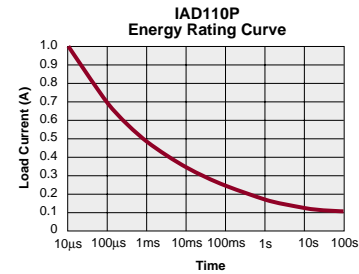
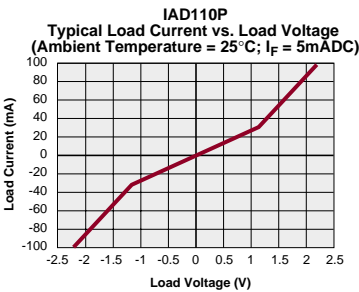
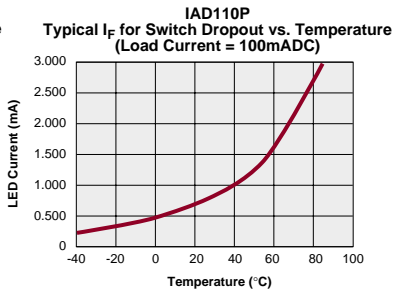
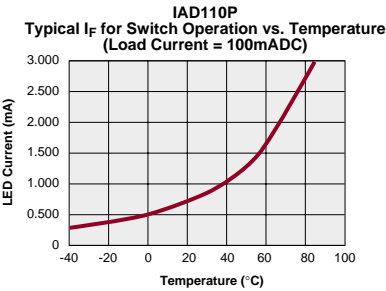
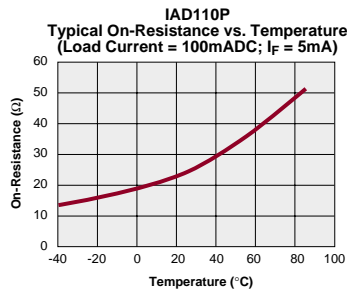
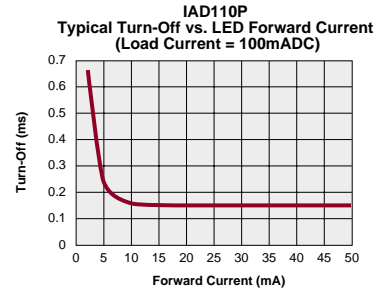
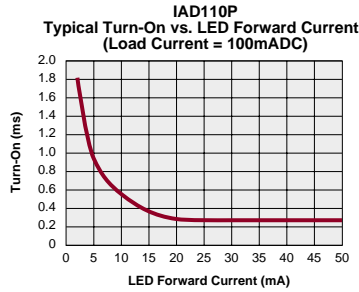
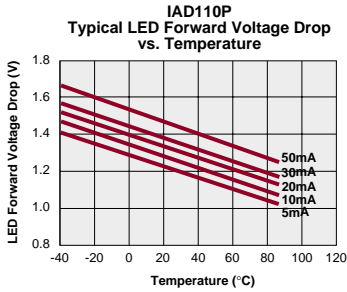

IAA170P/IAD170P



DESCRIPTION

The IAA170P and IAD170P multifunction switches combine a 350V, 120mA, 50Ω relay(s) and optocouplers in one package. Various combinations are available depending on the part number.

FEATURES

- Three Functions in One Package
- Small 16 Pin SOIC Package (PCMCIA Compatible)
- Bi-Directional Current Sensing
- Bi-Directional Current Switching
- Replaces up to Three or Four Components
- 3750V_{RMS} Input/Output Isolation
- FCC Compatible
- No EMI/RFI Generation
- Machine Insertable, Wave Solderable
- Tape & Reel Versions Available

APPROVALS

- UL Recognized: File Number E76270
- CSA Certified: File Number LR 43639-12
- VDE Compatible
- BSI Certified:
 - BS EN 60950:1992 (BS7002:1992) Certificate #:7969
 - BS EN 41003:1993 Certificate #:7969

OPTIONS / SUFFIXES

- TR: Tape & Reel

Switching Characteristics of Normally Closed (Form B) Devices

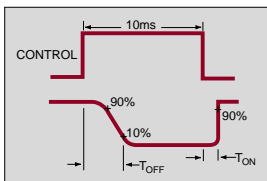

Switching Characteristics of Normally Open (Form A) Devices

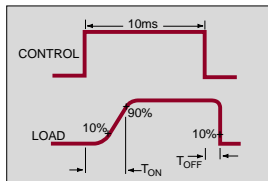

APPLICATIONS

- Telecommunications
 - Telecom Switching
 - Tip/Ring Circuits
 - Modem Switching (Laptop, Notebook, Pocket Size)
 - Hookswitch
 - Dial Pulsing
 - Ground Start
 - Ringer Injection
- Instrumentation
 - Multiplexers
 - Data Acquisition
 - Electronic Switching
 - I/O Subsystems
 - Meters (Watt-Hour, Water, Gas)
- Medical Equipment-Patient/Equipment Isolation
- Security
- Aerospace
- Industrial Controls

RATINGS (@ 25° C)

Parameter	Min	Typ	Max	Units
Total Package Dissipation	-	-	1 ¹	W
Isolation Voltage				
Input to Output	3750	-	-	V _{RMS}
Operational Temperature	-40	-	+85	°C
Storage Temperature	-40	-	+125	°C
Soldering Temperature (10 Seconds Max.)	-	-	+220	°C

¹ Above 25° derate linearly 1.67mw/°C

Note: For Mechanical Dimensions See Pages 396-401

SPECIFICATIONS

PARAMETERS	CONDITIONS	SYMBOL	MIN	TYP	MAX	UNITS
Relay Portion Output Characteristics @ 25°C						
Load Voltage (Peak)	-	V_L	-	-	350	V
Load Current (Continuous)	-	I_L	-	-	100	mA
Peak Load Current	10ms	I_{LPK}	-	-	350	mA
On-Resistance	$I_L=100\text{mA}$	R_{ON}	-	-	50	Ω
Off-State Leakage Current	$V_L=350\text{V}; T_J=25^\circ\text{C}$	I_{LEAK}	-	-	1	μA
Switching Speeds						
Turn-On	$I_F=5\text{mA}, V_L=10\text{V}$	T_{ON}	-	-	5	ms
Turn-Off	$I_F=5\text{mA}, V_L=10\text{V}$	T_{OFF}	-	-	5	ms
Output Capacitance	$V_L=50\text{V}, f=1\text{MHz}$	-	-	25	-	pF
Relay Portion Input Characteristics @ 25°C						
Input Control Current	$I_L=100\text{mA}$	I_F	5	-	50	mA
Input Dropout Current	$I_L=1\text{mA}$	I_F	0.4	-	-	mA
Input Voltage Drop	$I_F=5\text{mA}$	V_F	0.9	1.2	1.4	V
Reverse Input Voltage	-	V_R	-	-	5	V
Reverse Input Current	$V_R=5\text{V}$	I_R	-	-	10	μA
Detector Portion Output Characteristics @ 25°C						
Phototransistor Blocking Voltage	$I_C=10\mu\text{A}$	BV_{CEO}	20	50	-	V
Phototransistor Dark Current	$V_{CE}=5\text{V}, I_F=0\text{mA}$	I_{CEO}	-	50	500	nA
Saturation Voltage	$I_C=2\text{mA}, I_F=16\text{mA}$	V_{SAT}	-	0.3	0.5	V
Current Transfer Ratio	$I_F=6\text{mA}, V_{CE}=0.5\text{V}$	CTR	33	-	-	%
Detector Portion Input Characteristics @ 25°C						
Input Control Current	$I_C=2\text{mA}, V_{CE}=0.5\text{V}$	I_F	6	2	-	mA
Input Voltage Drop	$I_F=5\text{mA}$	I_{CEO}	0.9	1.2	1.4	V
Input Current (Detector must be off)	$I_C=1\mu\text{A}, V_{CE}=5\text{V}$	-	5	25	-	μA
Input to Output Capacitance	$V_L=50\text{V}, f=1\text{MHz}$	$C_{I/O}$	-	3	-	pF
Input to Output Isolation	-	$V_{I/O}$	3750	-	-	V_{RMS}

Note: For Mechanical Dimensions See Pages 396-401

EQUIVALENT CIRCUITS

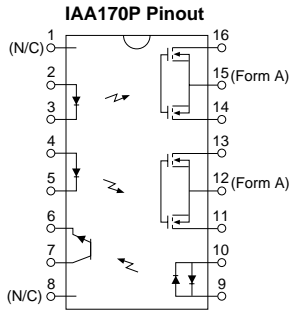

1. (N/C)
2. + LED - Form A Relay #1
3. - LED - Form A Relay #1
4. + LED - Form A Relay #2
5. - LED - Form A Relay #2
6. Emitter - Phototransistor
7. Collector - Phototransistor
8. (N/C)
9. LED - Phototransistor +/-
10. LED - Phototransistor -/+
11. Output - Form A Relay #2
12. Common Source Relay #2
13. Output - Form A Relay #2
14. Output - Form A Relay #1
15. Common Source Relay #1
16. Output - Form A Relay #1

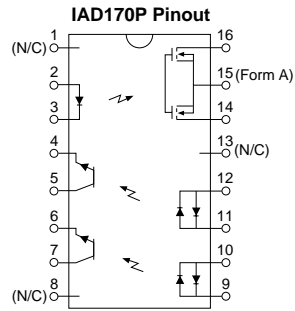

1. (N/C)
2. + LED - Relay Input
3. - LED - Relay Input
4. Emitter - Phototransistor #1
5. Collector - Phototransistor #1
6. Emitter - Phototransistor #2
7. Collector - Phototransistor #2
8. (N/C)
9. LED - Phototransistor +/- #2
10. LED - Phototransistor -/+ #2
11. LED - Phototransistor +/- #1
12. LED - Phototransistor -/+ #1
13. (N/C)
14. Output - Relay
15. Common - Relay
16. Output - Relay

Note: For Mechanical Dimensions See Pages 396-401

PERFORMANCE DATA

IAA170P
Typical LED Forward Voltage Drop
(N=50 Ambient Temperature = 25°C)
I_F = 5mA

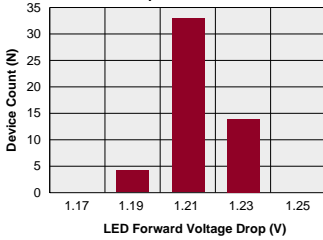

IAA170P
Typical On-Resistance Distribution
(N=50 Ambient Temperature = 25°C)
(Load Current = 100mA)

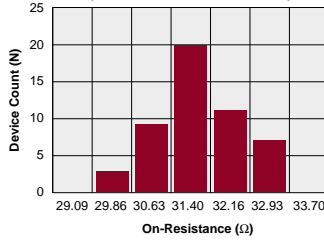

IAA170P
Typical Blocking Voltage Distribution
(N=50 Ambient Temperature = 25°C)

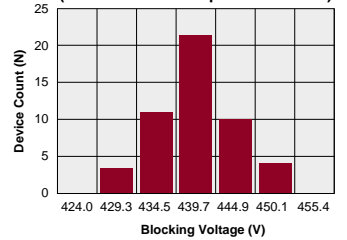

IAA170P
Typical I_F for Switch Operation
(N=50 Ambient Temperature = 25°C)
(Load Current = 100mA)

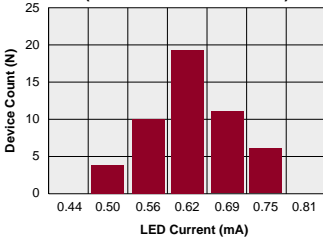

IAA170P
Typical I_F for Switch Dropout
(N=50 Ambient Temperature = 25°C)
(Load Current = 100mA)

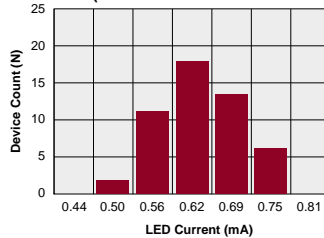

IAA170P
Typical Turn-On Time
(N=50 Ambient Temperature = 25°C)
(Load Current = 100mA)

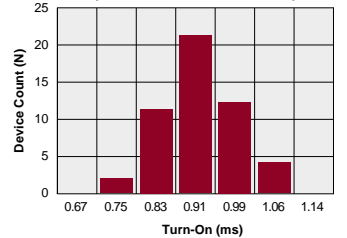

IAA170P
Typical Turn-Off Time
(N=50 Ambient Temperature = 25°C)
(Load Current = 100mA)

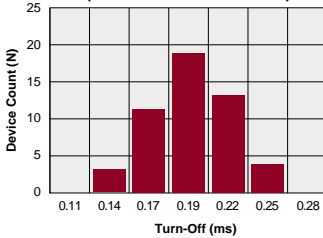

IAA170P
Typical Load Current vs. Temperature

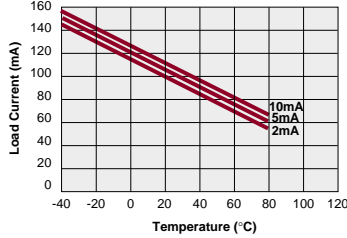

IAA170P
Typical Leakage vs. Temperature
(Measured across Pins 4 & 6)

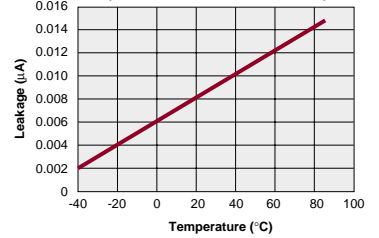

IAA170P
Typical Blocking Voltage vs. Temperature

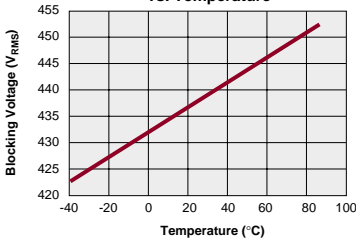

IAA170P
Typical Turn-On vs. Temperature
(Load Current = 100mA)

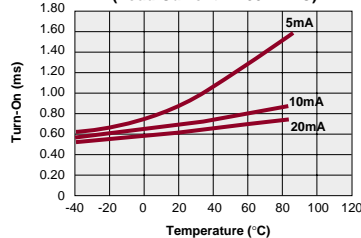

IAA170P
Typical Turn-Off vs. Temperature
(Load Current = 120mA)

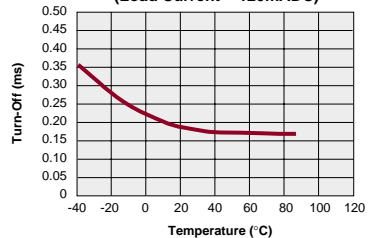

PERFORMANCE DATA

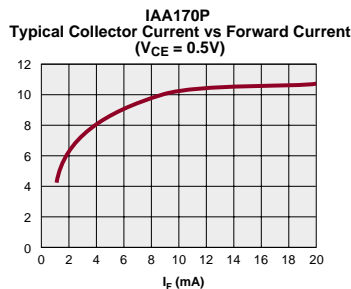
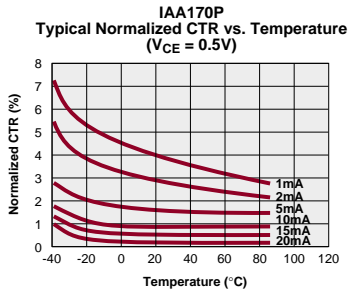
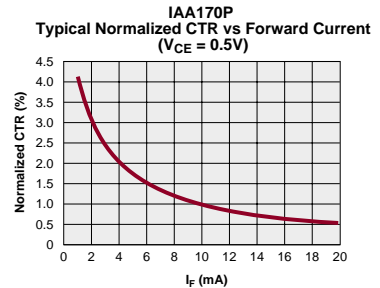
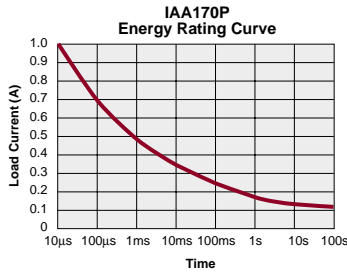
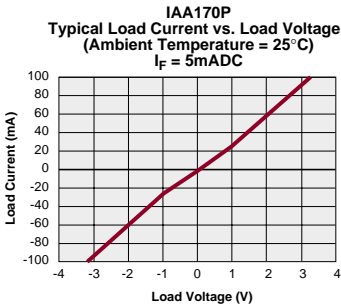
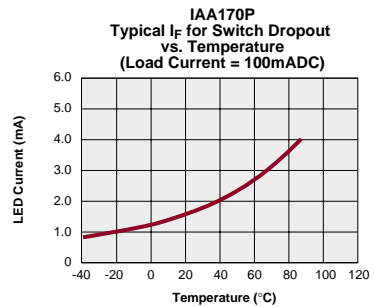
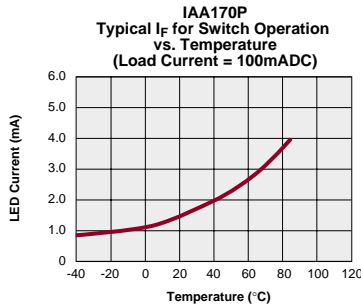
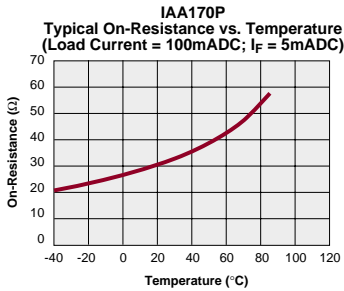
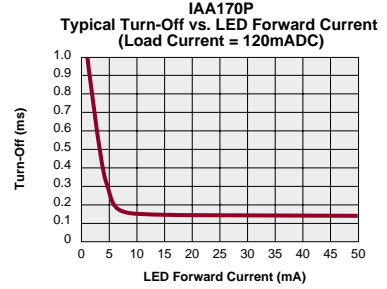
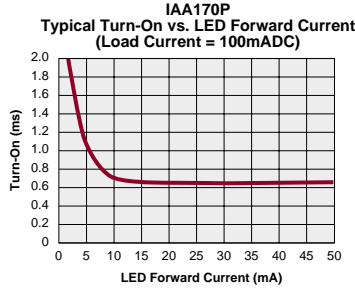
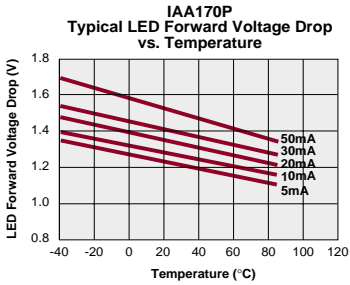

PERFORMANCE DATA

IAD170P
Typical LED Forward Voltage Drop
(N=50 Ambient Temperature = 25°C)
I_F = 5mA

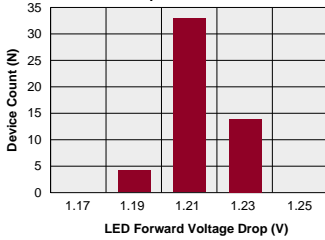

IAD170P
Typical On-Resistance Distribution
(N=50 Ambient Temperature = 25°C)
(Load Current = 100mADC)

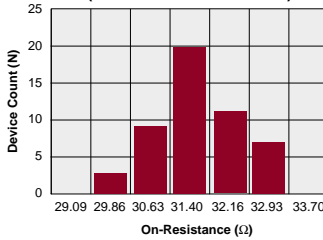

IAD170P
Typical Blocking Voltage Distribution
(N=50 Ambient Temperature = 25°C)

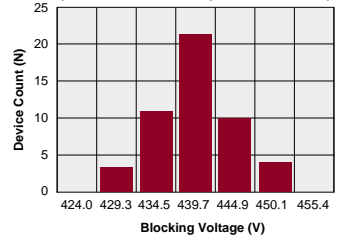

IAD170P
Typical I_F for Switch Operation
(N=50 Ambient Temperature = 25°C)
(Load Current = 100mADC)

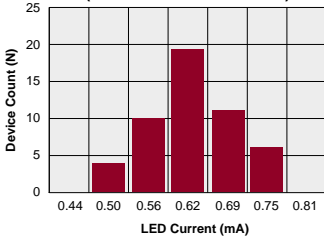

IAD170P
Typical I_F for Switch Dropout
(N=50 Ambient Temperature = 25°C)
(Load Current = 100mADC)

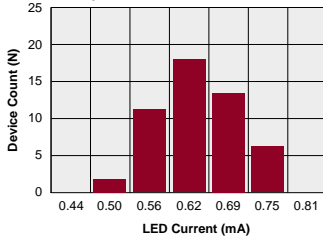

IAD170P
Typical Turn-On Time
(N=50 Ambient Temperature = 25°C)
(Load Current = 100mADC)

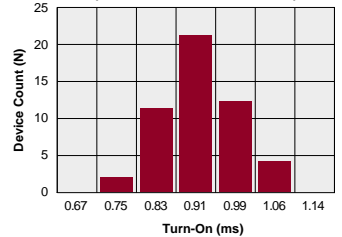

IAD170P
Typical Turn-Off Time
(N=50 Ambient Temperature = 25°C)
(Load Current = 100mADC)

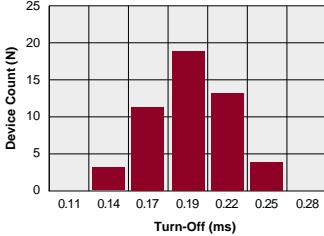

IAD170P
Typical Load Current vs. Temperature

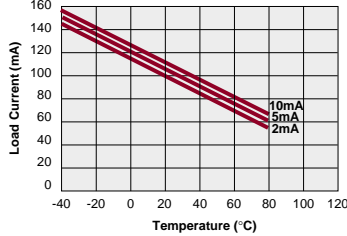

IAD170P
Typical Leakage vs. Temperature
(Measured across Pins 4 & 6)

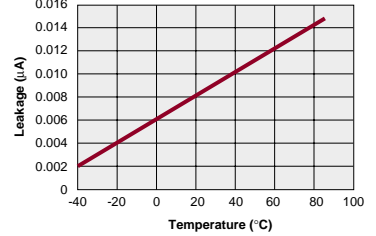

IAD170P
Typical Blocking Voltage vs. Temperature

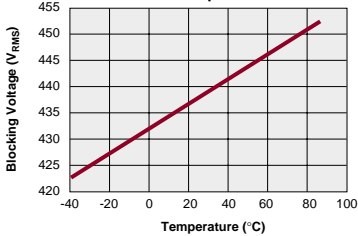

IAD170P
Typical Turn-On vs. Temperature
(Load Current = 100mADC)

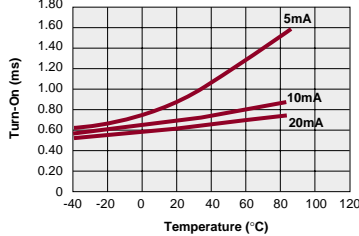

IAD170P
Typical Turn-Off vs. Temperature
(Load Current = 120mADC)

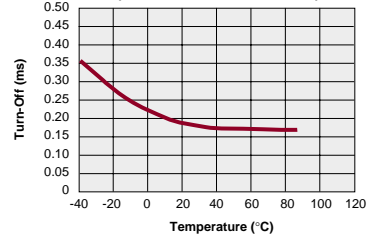

PERFORMANCE DATA

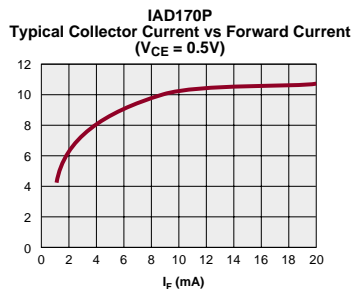
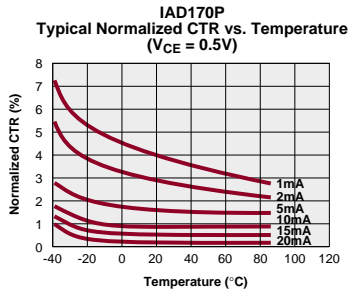
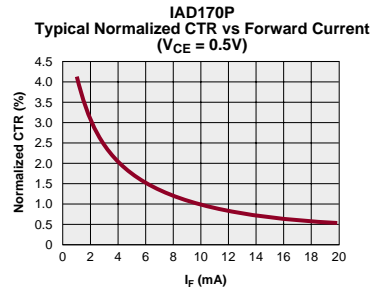
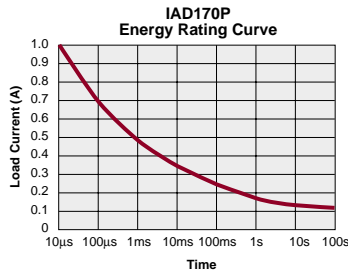
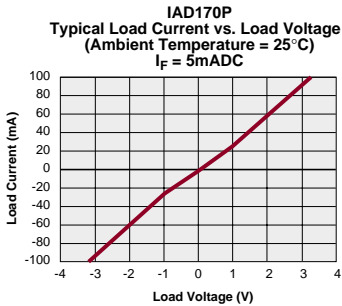
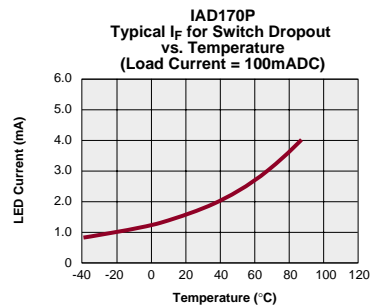
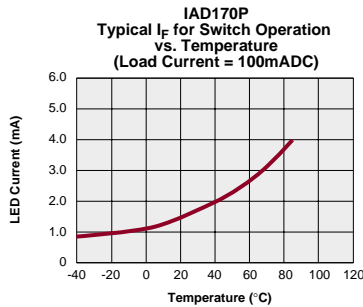
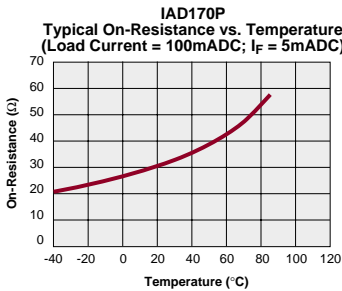
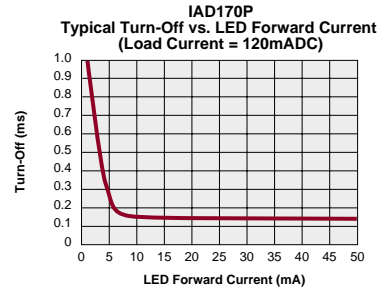
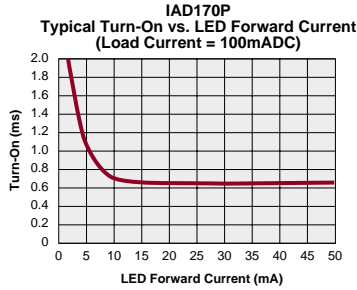
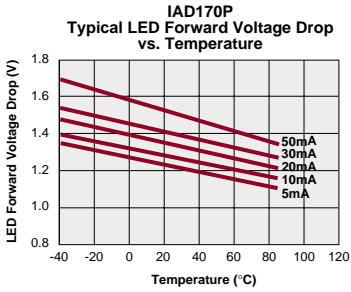



DESCRIPTION

The PLCA110 is a 350V, 120mA, 35Ω type 1-Form-A solid state relay with surge protection.

FEATURES

- Small 8 Pin DIP Package
- 2mW Drive Power (Logic Compatible)
- No Moving Parts
- Loads up to 350V AC/DC and 120mA
- 3750V_{RMS} Input/Output Isolation
- Meets FCC Part 68
- VDE Compatible
- Inherent Surge Protection
- Repetitive Surges With No Degradation
- Board Space and Cost Savings
- Machine Insertable, Wave Solderable
- Current Limiting, Surface Mount and Tape & Reel Versions Available

APPROVALS

- UL Recognized: File Number E76270
- CSA Certified: File Number LR 43639-10
- BSI Certified:
 - BS EN 60950:1992 (BS7002:1992)
Certificate #:8029
 - BS EN 41003:1993
Certificate #:8029

OPTIONS / SUFFIXES

- S: Surface Mount Package
- TR: Tape & Reel

APPLICATIONS

- Telecom Switching
- Tip/Ring Circuits
- Modem Switching (Laptop, Notebook, Pocket Size)
- Hookswitch
- Dial Pulsing
- Ground Start
- Ringer Injection
- Loop Detect
- Ring Detect

RATINGS (@ 25° C)

Parameter	Min	Typ	Max	Units
Total Package Dissipation	-	-	1 ¹	W
Isolation Voltage				
Input to Output	3750	-	-	V _{RMS}
Operational Temperature	-40	-	+85	°C
Storage Temperature	-40	-	+125	°C
Soldering Temperature (10 Seconds Max.)				
DIP Package	-	-	+260	°C
Surface Mount Package	-	-	+220	°C

¹ Above 25° derate linearly 1.67mw/°C

PLCA110 Pinout

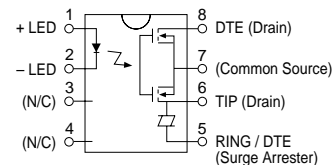

Note: For Mechanical Dimensions See Pages 396-401

SPECIFICATIONS

PARAMETERS	CONDITIONS	SYMBOL	MIN	TYP	MAX	UNITS
Relay Ratings						
Output Characteristics @ 25°C						
Load Voltage (Peak)	-	V_L	-	-	350	V
Load Current (Continuous)	-	I_L	-	-	120	mA
Off-State Leakage Current	$V_L=350V$	I_{LEAK}	-	-	1	μA
On-Resistance	$I_L=120mA$	R_{ON}	-	23	35	Ω
Turn-on Time	$I_F=5mA, V_L=10V$	T_{ON}	-	-	3	ms
Turn-off Time	$I_F=5mA, V_L=10V$	T_{OFF}	-	-	2	ms
Output Capacitance	-	C_{OUT}	-	25	-	pF
Relay Ratings						
Input Characteristics @ 25°C						
Input Control Current	$I_L=120mA$	I_F	2	-	50	mA
Input Drop Out Voltage	-	V_F	0.8	-	-	V
Input Voltage Drop	$I_F=5mA$	V_F	0.9	1.2	1.4	V
Reverse Input Voltage	-	V_R	-	-	5	V
Reverse Input Current	$V_R=5V$	I_R	-	-	10	μA
Surge Arrester Ratings						
Absolute Maximum Ratings @ 25°C						
Non-Repetitive Surge	10/560 μs (FCC Part 68.302)	I_{TSP}	-	-	100	A_{PK}
Non-Repetitive Surge	8/20 μs (ANSI Std. c.62) ^{1,2}	I_{TSP}	-	-	150	A_{PK}
Non-Repetitive Surge	50Hz On-State Current 0.7s ^{1,2}	I_{TSM}	-	-	10	A_{RMS}
Critical Rate of Rise	Initial Rate of Rise of On-State Control	di/dt	-	-	250	A/ μs
Junction Temperature	-	$T_{J(MAX)}$	-	-	150	°C
Surge Arrester Ratings						
Electrical Characteristics @ 25°C						
REF Zener Voltage	$I_Z=1mA$	V_Z	± 260	± 285	± 320	V
Breakover Voltage	-	V_{BO}	± 283	± 305	± 340	V
Breakover Current	-	I_{BO}	0.15	-	0.6	A
Holding Current	-	I_H	± 150	-	-	mA
Off-State Leakage	$V=50V$	I_D	-	-	10	μA
Off-State Capacitance	$V=0V, f=1kHz$	C_{OFF}	-	-	200	pF
Input to Output Capacitance		$C_{I/O}$	-	3	-	pF
Input to Output Isolation		$V_{I/O}$	3750	-	-	V_{RMS}

¹ Above 70°C derate linearly to zero at 150°C case temperature

² This value applies when the initial case temperature is at or below 70°C. The surge may be repeated after the device has returned to thermal equilibrium.

Note: For Mechanical Dimensions See Pages 396-401

PERFORMANCE DATA

PLCA110
Typical LED Forward Voltage Drop
(N=50 Ambient Temperature = 25°C; I_F = 5mADC)

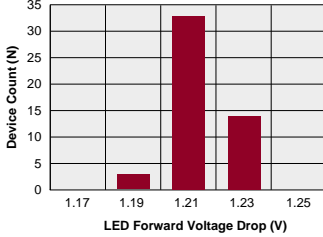

PLCA110
Typical On-Resistance Distribution
(N=50 Ambient Temperature = 25°C;
Load: Voltage = 350VDC; Current = 120mADC;
I_F = 2mADC)

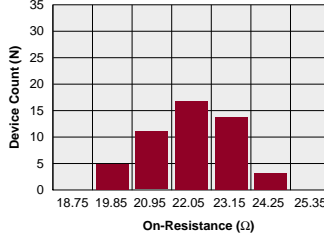

PLCA110
Typical Blocking Voltage Distribution
(N=50 Ambient Temperature = 25°C)

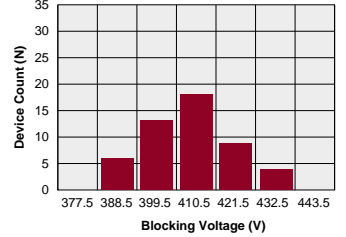

PLCA110
Typical I_F for Switch Operation
(N=50 Ambient Temperature = 25°C)
(Load Current = 120mADC)

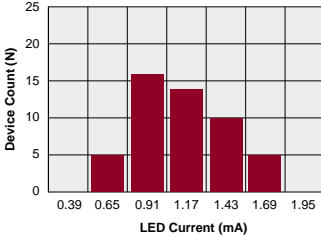

PLCA110
Typical I_F for Switch Dropout
(N=50 Ambient Temperature = 25°C)
(Load Current = 120mADC)

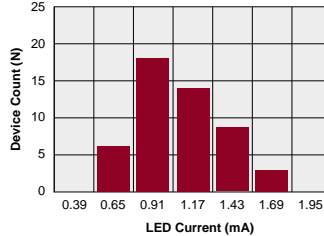

PLCA110
Typical Turn-On Time
(N=50 Ambient Temperature = 25°C)
(Load Current = 120mADC; I_F = 2mADC)

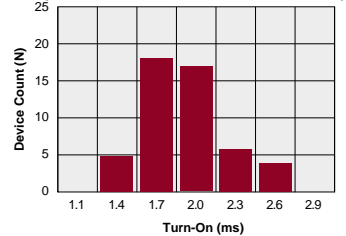

PLCA110
Typical Turn-Off Time
(N=50 Ambient Temperature = 25°C)
(Load Current = 120mADC; I_F = 2mADC)

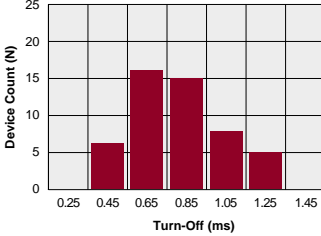

PLCA110
Typical Load Current vs. Temperature

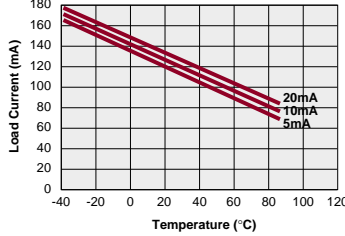

PLCA110
Typical Leakage vs. Temperature
(Measured across Pins 6 & 8)

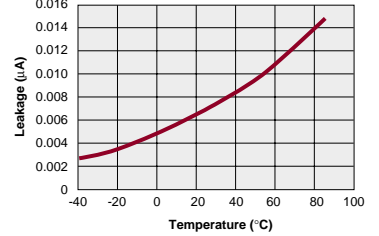

PLCA110
Typical Blocking Voltage vs. Temperature

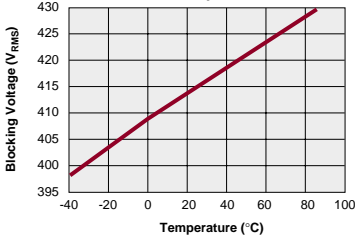

PLCA110
Typical Turn-On vs. Temperature
(Load Current = 120mADC)

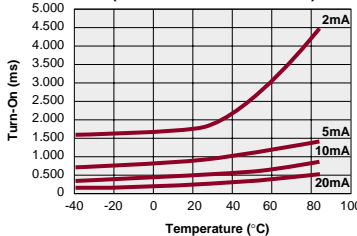

PLCA110
Typical Turn-Off vs. Temperature
(Load Current = 120mADC)

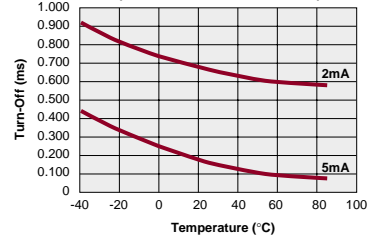

PERFORMANCE DATA

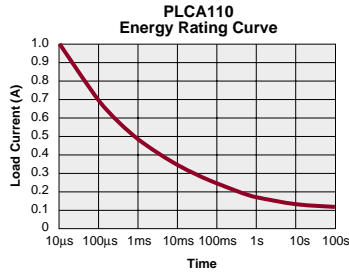
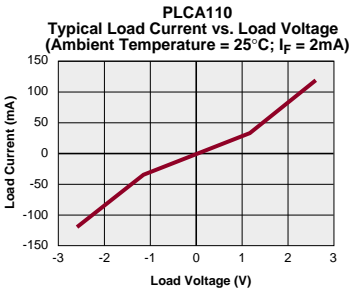
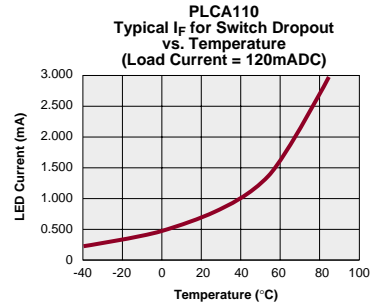
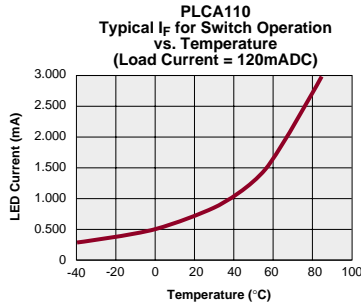
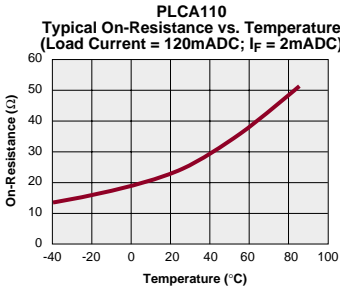
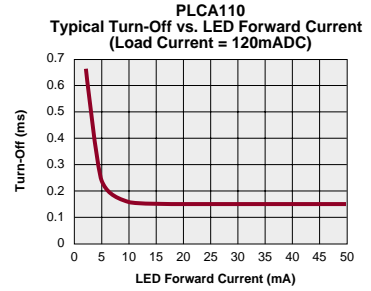
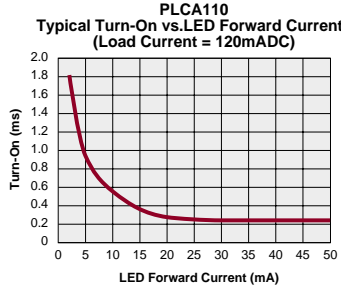
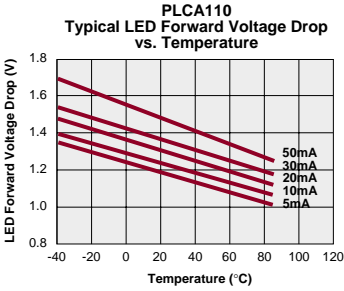

Linear Optocouplers and Linear Isolation Amplifiers



CP Clare's family of Linear Optocouplers feature an infrared LED optically coupled with two phototransistors. One feedback (input) phototransistor is used to generate a control signal that provides a servomechanism to the LED's nonlinear time and temperature characteristics. The other (output) phototransistor provides an output signal that is linear with respect to the servo LED current.

CP Clare's LIA Series Linear Isolation Amplifiers integrate a linear optocoupler with two independent LF356 op-amps in a single 16 pin SOIC or DIP package. These linear isolation amplifiers can couple both AC and DC signals in either uni-polar or bi-polar modes, while providing up to $5300V_{PEAK}$ input/output isolation. Unlike conventional optocouplers, the LIA100 Series uses a servo control loop to compensate for the nonlinear time and temperature characteristics of the LED, thereby achieving significantly improved linearity and stability.

Linear Optocouplers and Linear Isolation Amplifiers

Part Number	LOC110	LOC111	LOC112	LOC210P	LOC211P	LIA100	LIA101	Units
Package Type	8 Pin DIP	8 Pin DIP	8 Pin DIP	16 Pin SOIC	16 Pin SOIC	16 Pin DIP or SOIC	16 Pin DIP or SOIC	-
<i>Input Characteristics</i>								
LED Current to Operate (min)	2	2	2	2	2	2	2	mA
<i>Coupler/Detector Characteristics</i>								
K1, Servo Gain @ $I_f=2mA - 10mA, V_{cc}=15V$.004/.030	0.008/.030	.004/.030	.004/.03	0.008/.03	.004/.007	.004/.007	min/max
K2, Forward Gain (I_1/I_2) @ $I_f=2mA - 10mA, V_{cc}=15V$.004/.030	0.006/.030	.004/.030	.004/.03	0.006/.03	.004/.007	.004/.007	min/max
K3, Transfer Gain ($K1/K2$) @ $I_f=2mA - 10mA, V_{cc}=15V$.5/1.43	.733/1.072	.5/1.43	.733/1.072	.733/1.072	.5/1.43	.733/1.072	min/max
Common Mode Rejection Ratio, $V=20Vp-p, R_f=2K, F=100Hz$	130	130	130	130	130	100	100	db (Typ)
Frequency Response: Photoconductive Operation BW (-3dB)	200	200	200	200	200	200	200	KHz(Typ)
Photovoltaic Operation BW (-3dB)	40	40	40	40	40	40	40	KHz(Typ)
Non-Linearity (max)	-	-	-	-	-	0.01%	0.01%	%
Dark Current (max)	25	25	25	25	25	25	25	nA
Power Supply Range	n/a	n/a	n/a	n/a	n/a	+/- 18	+/- 18	V
Isolation Voltage	3750	3750	3750	3750	3750	3750	3750	V_{RMS}

ORDERING INFORMATION

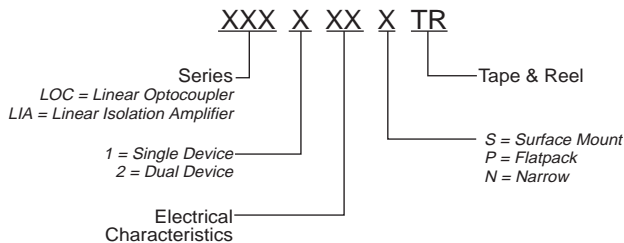

LINEAR OPTOCOUPLERS

LOC110/LOC111/LOC112



FEATURES

- 8 Pin Flatpack or DIP Package (PCMCIA Compatible)
- Couples Analog and Digital Signals
- Wide Bandwidth (>200kHz)
- High Gain Stability
- Low Input/Output Capacitance
- Low Power Consumption
- 0.01% Servo Linearity
- THD 87dB Typical
- Machine Insertable, Wave Solderable
- Surface Mount and Tape Reel Versions Available
- VDE Compatible

APPROVALS

- UL Recognized File #: E76270
- CSA Certified File #: LR 43639-10
- BSI Certified:
 - BS EN 60950:1992 (BS7002:1992) Certificate #: 7962 and 7694 (flatpack version)
 - BS EN 415:1990 Certificate #: 7692 and 7694 (flatpack version)

OPTIONS / SUFFIXES

- P: Flatpack Package
- S: Surface Mount Package
- TR: Tape & Reel

DESCRIPTION

The LOC110, LOC111 and LOC112 are linear optocouplers for use in telecom, medical and power supply isolation circuits. These devices are available in 8 pin DIP, surface mount or flatpack packages.

APPLICATIONS

- Modem Transformer Replacement With No Insertion Loss
- Digital Telephone Isolation
- Power Supply Feedback Voltage/Current
- Medical Sensor Isolation
- Audio Signal Interfacing
- Isolation of Process Control Transducers

RATINGS (@ 25° C)

Parameter	Min	Typ	Max	Units
Input Power Dissipation	-	-	150 ¹	mW
Input Control Current	-	-	100	mA
Peak (10ms)	-	-	1	A
Total Package Dissipation	-	-	500 ²	mW
Isolation Voltage				
Input to Output	3750	-	-	V _{RMS}
Operational Temperature	-40	-	+85	°C
Storage Temperature	-40	-	+125	°C
Soldering Temperature (10 Seconds Max.)				
DIP Package	-	-	+260	°C
Flatpack/Surface Mount Pkg	-	-	+220	°C

¹ Derate Linearly 1.33 mW/°C
² Derate Linearly 1.67 mW/°C

LOC110/LOC111/LOC112 Pinout

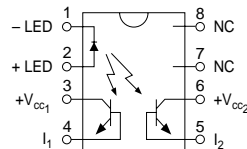

Note: For Mechanical Dimensions See Pages 396-401

SPECIFICATIONS

PARAMETERS	CONDITIONS	SYMBOL	LOC110			LOC111			LOC112			UNITS
			MIN	TYP	MAX	MIN	TYP	MAX	MIN	TYP	MAX	
Input Characteristics @ 25°C												
LED Voltage Drop	$I_F=2-10\text{mA}$	V_F	0.9	1.2	1.4	0.9	1.2	1.4	0.9	1.2	1.4	V
Reverse LED Current	$V_R=5\text{V}$	I_R	-	-	10	-	-	10	-	-	10	μA
Reverse LED Voltage	-	V_R	-	-	5	-	-	5	-	-	5	V
Forward LED Current	-	I_F	-	-	100	-	-	100	-	-	100	mA
Coupler/Detector Characteristics @ 25°C												
Dark Current	$I_F=0\text{mA}, V_{CC}=15\text{V}$	I_D	-	1	25	-	1	25	-	1	25	nA
K1, Servo Gain (I_1/I_F)	$I_F=2-10\text{mA}, V_{CC}=15\text{V}$	K1	0.004	0.007	0.030	0.008	-	0.030	0.004	0.007	0.030	-
K2, Forward Gain (I_2/I_F)	$I_F=2-10\text{mA}, V_{CC}=15\text{V}$	K2	0.004	0.007	0.030	0.006	-	0.030	0.004	0.007	0.030	-
K3, Transfer Gain (K_2/K_1) ¹	$I_F=2-10\text{mA}, V_{CC}=15\text{V}$	K3	0.550	1.0	1.430	0.733	1.0	1.072	0.733	1.0	1.072	-
$\Delta K3$, Transfer Gain Linearity ¹ (non-servoed)	$I_F=2-10\text{mA}$	$\Delta K3$	-	-	1.0	-	-	1.0	-	-	1.0	%
K3 Temperature Coefficient	$I_F=2-10\text{mA}, V_{det}=-5\text{V}$	$\Delta K3/\Delta T$	-	0.005	-	-	0.005	-	-	0.005	-	%/°C
Common Mode Rejection Ratio	$V=20V_{P-P}, R_L=2K\Omega,$ $F=100\text{Hz}$	CMRR	-	130	-	-	130	-	-	130	-	dB
Total Harmonic Distortion	$F_0=350\text{Hz}, 0\text{dBm}$	THD	-96	-87	-80	-96	-87	-80	-96	-87	-80	dB
Frequency Response	Photoconductive Operation	BW (-3dB)	-	200	-	-	200	-	-	200	-	kHz
	Photovoltaic Operation	BW (-3dB)	-	40	-	-	40	-	-	40	-	kHz
Input/Output Capacitance	-	$C_{I/O}$	-	3	-	-	3	-	-	3	-	pF
Input/Output Isolation	-	$V_{I/O}$	2500	-	-	2500	-	-	2500	-	-	V_{RMS}

¹ LOC111 and LOC112 Bins D,E,F,G.

K3 Sorted Bins

Bin A = 0.550-0.605
Bin B = 0.606-0.667
Bin C = 0.668-0.732
Bin D = 0.733-0.805
Bin E = 0.806-0.886
Bin F = 0.887-0.974
Bin G = 0.975-1.072
Bin H = 1.073-1.179
Bin I = 1.180-1.297
Bin J = 1.298-1.426

- The LOC110/LOC111/LOC112 are shipped in anti-static tubes of 50 pieces. Each tube will contain one K3 sorted bin.
- Bin designation marked on each device (A-J).
- Orders for the LOC110 product will be shipped using bins available at the date of the order. Any bin (A-J) can be shipped.
- For customers requiring selected bins D E F G we offer part numbers LOC111 or LOC112.

Note: For Mechanical Dimensions See Pages 396-401

www.cpcclare.com

PERFORMANCE DATA

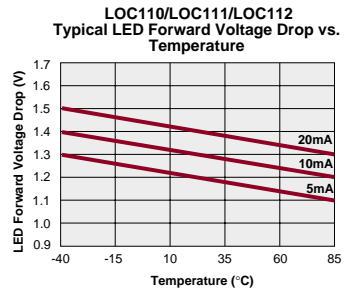
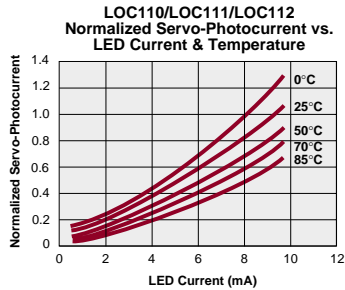
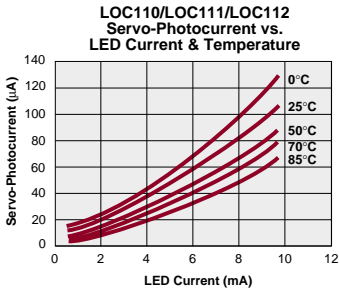
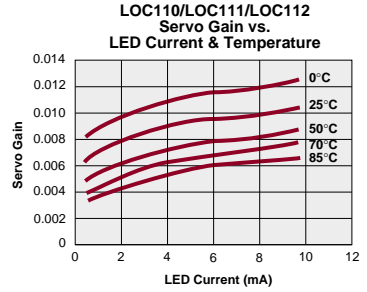
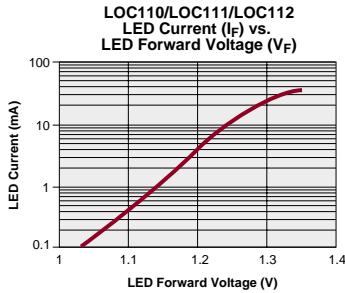
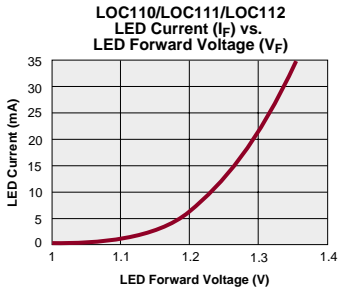



FEATURES

- 16 Pin SOIC Package (PCMCIA Compatible)
- Couples Analog and Digital Signals
- Wide Bandwidth (>200kHz)
- High Gain Stability
- Low Input/Output Capacitance
- Low Power Consumption
- 0.01% Servo Linearity
- THD 87dB Typical
- Machine Insertable, Wave Solderable
- Surface Mount and Tape Reel Versions Available
- VDE Compatible

APPROVALS

- UL Recognized File #: E76270
- CSA Certified File #: LR 43639-12
- BSI Certified:
 - BS EN 60950:1992 (BS7002:1992) Certificate #:7969
 - BS EN 41003:1993 Certificate #:7969
 - UL/CSA & BSI: Pending - Narrow

OPTIONS / SUFFIXES

- N: Narrow Package
- P: Flatpack Package
- TR: Tape & Reel

DESCRIPTION

The LOC210 and LOC211 are dual linear optocouplers for use in telecom, medical and power supply isolation circuits. They are available in a 16 Pin SOIC package.

APPLICATIONS

- Modem Transformer Replacement With No Insertion Loss
- Digital Telephone Isolation
- Power Supply Feedback Voltage/Current
- Medical Sensor Isolation
- Audio Signal Interfacing
- Isolation of Process Control Transducers

RATINGS (@ 25° C)

Parameter	Min	Typ	Max	Units
Input Power Dissipation	-	-	150 ¹	mW
Input Control Current	-	-	100	mA
Peak (10ms)	-	-	1	A
Total Package Dissipation	-	-	800 ²	mW
Isolation Voltage				
Input to Output	3750	-	-	V_{RMS}
Flatpack Package	1500	-	-	V_{RMS}
Narrow Package				
Operational Temperature	-40	-	+85	°C
Storage Temperature	-40	-	+125	°C
Soldering Temperature (10 Seconds Max)	-	-	+220	°C
Flatpack Package	-	-	+260	°C
Narrow Package	-	-	+260	°C

¹ Derate Linearly 1.33 mW/°C
² Derate Linearly 1.67 mW/°C

LOC210/LOC211 Pinout

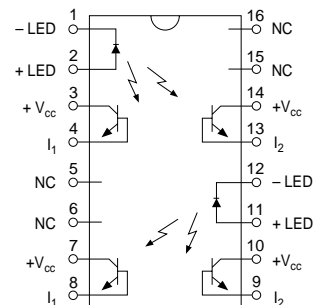

Note: For Mechanical Dimensions See Pages 396-401

SPECIFICATIONS

PARAMETERS	CONDITIONS	SYMBOL	LOC210			LOC211			UNITS
			MIN	TYP	MAX	MIN	TYP	MAX	
Input Characteristics @ 25°C¹									
LED Voltage Drop	$I_F=2-10\text{mA}$	V_F	0.9	1.2	1.4	0.9	1.2	1.4	V
Reverse LED Current	$V_R=5\text{V}$	I_R	-	-	10	-	-	10	μA
Reverse LED Voltage	-	V_R	-	-	5	-	-	5	V
Forward LED Current	-	I_F	-	-	100	-	-	100	mA
Coupler/Detector Characteristics @ 25°C¹									
Dark Current	$I_F=0\text{mA}, V_{CC}=15\text{V}$	I_D	-	1	25	-	1	25	nA
K1, Servo Gain (I_1/I_F)	$I_F=2-10\text{mA}, V_{CC}=15\text{V}$	K1	0.004	0.007	0.030	0.008	-	0.030	-
K2, Forward Gain (I_2/I_F)	$I_F=2-10\text{mA}, V_{CC}=15\text{V}$	K2	0.004	0.007	0.030	0.006	-	0.030	-
K3, Transfer Gain (K_2/K_1)	$I_F=2-10\text{mA}, V_{CC}=15\text{V}$	K3	0.733	-	1.072	0.733	-	1.072	-
$\Delta K3$, Transfer Gain Linearity (non-servoed)	$I_F=2-10\text{mA}$	$\Delta K3$	-	-	1.0	-	-	1.0	%
K3 Temperature Coefficient	$I_F=2-10\text{mA}, V_{det}=-5\text{V}$	$\Delta K3/\Delta T$	-	0.005	-	-	0.005	-	%/°C
Common Mode Rejection Ratio	$V=20\text{V}_{p,p}, R_L=2\text{K}\Omega, F=100\text{Hz}$	CMRR	-	130	-	-	130	-	dB
Total Harmonic Distortion	$F_0=350\text{Hz}, 0\text{dBm}$	THD	-96	-87	-80	-96	-87	-80	dB
Frequency Response	Photoconductive Operation	BW (-3dB)	-	200	-	-	200	-	kHz
	Photovoltaic Operation	BW (-3dB)	-	40	-	-	40	-	kHz
Input/Output Capacitance	-	$C_{I/O}$	-	3	-	-	3	-	pF
Input/Output Isolation	Flatpack Package	$V_{I/O}$	3750	-	-	3750	-	-	V_{RMS}
	Narrow Package	$V_{I/O}$	1500	-	-	1500	-	-	V_{RMS}

¹ All parameters above are for each optocoupler.

K3 Sorted Bins

Bin 1 = 0.773 - 0.886

Bin 2 = 0.887 - 1.072

Bin Matrix

Suffix	Bin	
	Top Pole Optocoupler*	Bottom Pole Optocoupler**
K	1	1
L	1	2
M	2	1
N	2	2

*Top Pole Optocoupler: Pins 1, 2, 3, 4, 13, and 14

**Bottom Pole Optocoupler: Pins 7 through 12

Note: For Mechanical Dimensions See Pages 396-401

Part Number Information

The LOC210P and LOC211P are shipped in anti-static tubes (50 pieces each) or tape/reel (1,000 pieces each). Each container has only 1 bin combination which will be branded on each part with the appropriate bin letter K, L, M, or N in the lower right hand corner. Suffix representation is described in the "Bin Matrix".

PERFORMANCE DATA

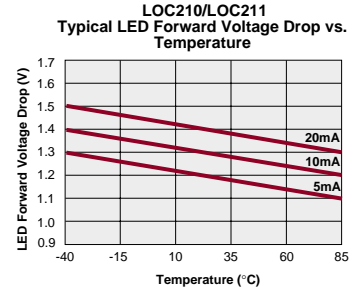
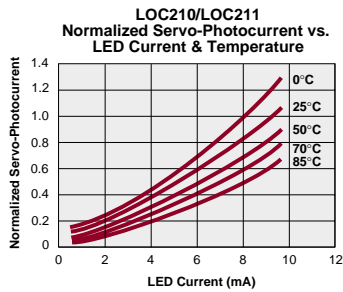
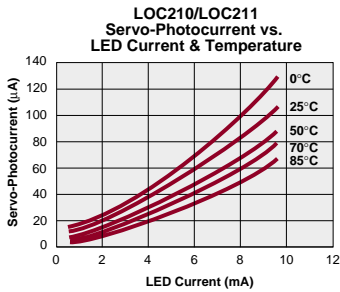
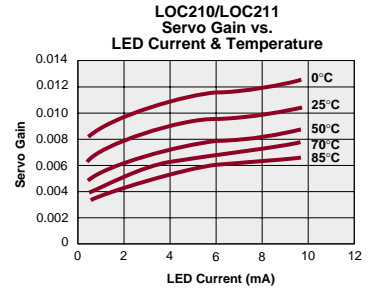
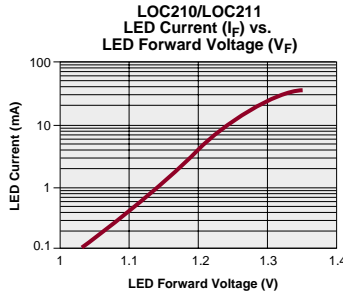
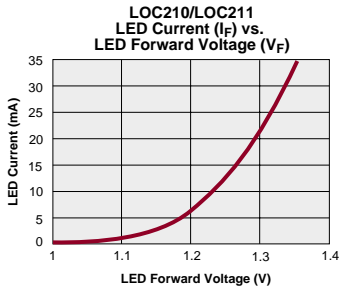

LINEAR ISOLATION AMPLIFIER

LIA100/LIA101



FEATURES

- Small Size Standard 16 Pin SOIC or DIP Package
- 0.01% Servo Linearity
- 5300 VAC Peak Input/Output Isolation Available
- Bandwidth $\geq 40\text{kHz}$
- Machine Insertable, Wave Solderable
- Wide Power Supply Range $\pm 18\text{V}$
- Low Supply Current

APPROVALS

- UL Recognized File #: E76270
- BSI Certified:
 - BS EN 60950:1992 (BS7002:1992) Certificate #:7969
 - BS EN 41003:1993 Certificate #:7969

OPTIONS / SUFFIXES

- P: SOIC Package
- S: Surface Mount Package
- TR: Tape & Reel

DESCRIPTION

The LIA100 and LIA101 are linear isolation amplifiers that integrate a linear optocoupler with two op amps in a single package. They are available in a 16 Pin SOIC or DIP package.

APPLICATIONS

- Isolated 4-20mA Converter
- Medical Sensor Isolation
- Switching Power Supply Feedback Circuits
- Isolated Temperature/Pressure Sensors
- Data Acquisition Equipment
- Isolated Motor Controls

RATINGS (@ 25°C)

Parameter	Min	Typ	Max	Units
Supply Voltages	± 5	-	± 18	V
Differential Input Voltage	-	-	± 30	V
Output Short Circuit Duration	Continuous			-
Total Package Dissipation	-	-	1 ¹	W
Isolation Voltage				
Input to Output	3750	-	-	V_{RMS}
Operational Temperature	-40	-	+85	°C
Storage Temperature	-40	-	+125	°C
Soldering Temperature (10 Seconds Max.)				
DIP Package	-	-	+260	°C
Surface Mount Package	-	-	+220	°C

¹Above 25°C Derate Linearly 1.67mW/°C

LIA100/LIA101 Pinout

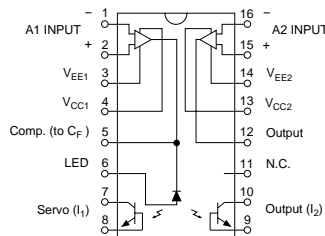

Note: For Mechanical Dimensions See Pages 396-401

SPECIFICATIONS

Electrical Specifications @ $T_A = +25^\circ\text{C}$ and $\pm V_{CC} = 15\text{VDC}$ (unless otherwise specified)

PARAMETERS	CONDITIONS	LIA100			LIA101			UNITS
		MIN	TYP	MAX	MIN	TYP	MAX	
Isolation								
Continuous Voltage, AC	-	-	-	3750	-	-	3750	V_{RMS}
Input to Output Leakage Current	1000V _{RMS} , 60Hz	-	0.2	-	-	0.2	-	μA_{RMS}
Offset Voltage								
Output Offset Voltage (V_{OS})	$R_F=R_{IN}=51\text{K}\Omega$, $K3=1.000$ Input Grounded $T_A=25^\circ\text{C}$	-	50	-	-	50	-	mV
Amplifier Input Impedance	-	-	$10^{12} \parallel 3$	-	-	$10^{12} \parallel 3$	-	$\Omega \parallel \text{pF}$
$\Delta V_{OS}/\Delta T$ Average TC of Input Offset Voltage	$R_S=50\Omega$	-	5	-	-	5	-	$\mu\text{V}/^\circ\text{C}$
(Input and Output Stage)								
Common Mode Rejection Ratio, CMRR	60Hz, $R_F=1\text{M}\Omega$ $R_{IN}=10\text{K}\Omega$, Gain=100	-	100	-	-	100	-	dB
Input Offset Voltage	$R_S=50\Omega$, $T_A=25^\circ\text{C}$	-	3	10	-	3	10	mV
Common Mode Range		± 12	-	-	± 12	-	-	V
Frequency Response								
Bandwidth	-	-	40	-	-	40	-	kHz
Slew Rate	0-10V Step Input	-	0.3	-	-	0.3	-	V/ μs
Non-Linearity	$F_0=300\text{Hz}$, -10dBm	-	-	0.01	-	-	0.01	%
Power Supplies								
Input Stage Supply Voltage V_{CC1} , V_{EE1}	-	± 5	-	± 18	± 5	-	± 18	V
Output Stage Supply Voltage V_{CC2} , V_{EE2}	-	± 5	-	± 18	± 5	-	± 18	V
Input (A1) & Output Stage (A2) Supply Current	-	-	5	10	-	5	10	mA
Power Supply Rejection Ratio, PSRR	-	-	80	100	-	80	100	dB
LED Parameters								
Forward LED Current (I_F)	-	-	-	20	-	-	20	mA
LED Forward Voltage Drop (V_F)	$I_F=10\text{mA}$	0.9	1.2	1.4	0.9	1.2	1.4	V
Reverse LED Current	$V_R=5\text{V}$	-	-	10	-	-	10	μA
Reverse LED Voltage	-	-	-	5	-	-	5	V
Coupled Characteristics								
K1, Servo Gain (I_1/I_F)	-	0.004	0.008	0.030	0.004	0.008	0.030	
K2, Forward Gain (I_2/I_F)	-	0.004	0.008	0.030	0.004	0.008	0.030	
K3, Transfer Gain (K2/K1)	-	0.550	1.000	1.420	0.733	1.000	1.072	
K3, Temperature Coefficient	Over Temperature Range	-	0.005	-	-	0.005	-	$\%/^\circ\text{C}$
Temperature Range								
Operating	-	-40	-	+85	-40	-	+85	$^\circ\text{C}$
Storage	-	-40	-	+125	-40	-	+125	$^\circ\text{C}$

K3 Sorted Bins

Bin A	= 0.550-0.605
Bin B	= 0.606-0.667
Bin C	= 0.668-0.732
Bin D	= 0.733-0.805
Bin E	= 0.806-0.886
Bin F	= 0.887-0.974
Bin G	= 0.975-1.072
Bin H	= 1.073-1.179
Bin I	= 1.180-1.297
Bin J	= 1.298-1.426

- The LIA101 Series (through hole) is shipped in anti-static tubes of 25 pieces. The LIA100P Series (flatpack) is shipped in anti-static tubes of 50 pieces. Each tube will contain one K3 sorted bin.
- Bin designation marked on each device (A-J).
- Orders for the LIA100/LIA100P product will be shipped using bins available at the date of the order. Any bin (A-J) can be shipped.
- For customers requiring selected bins D E F G we offer part numbers LIA101/LIA101P.

Note: For Mechanical Dimensions See Pages 396-401

LIA100/LIA101

PERFORMANCE DATA

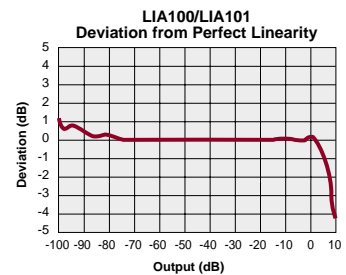
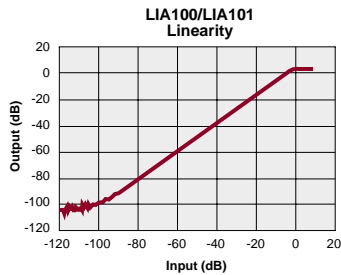
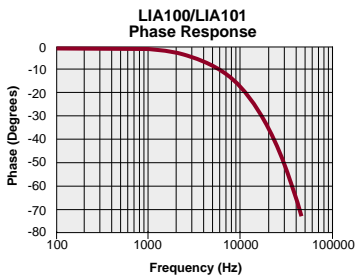
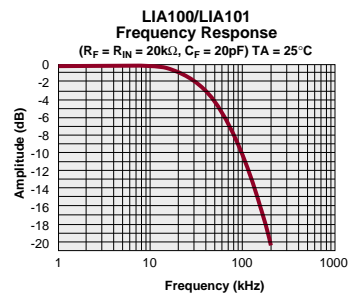
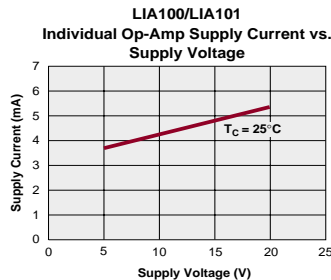
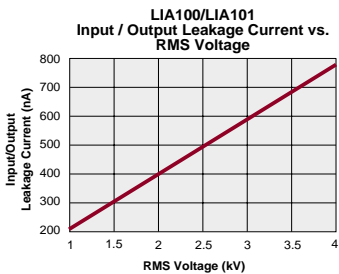
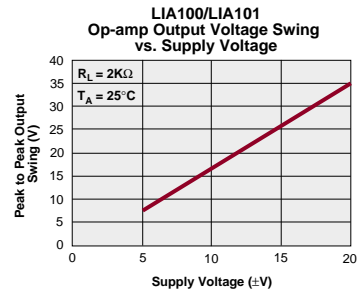
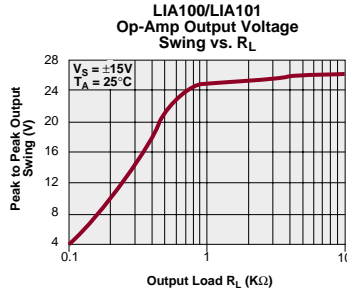
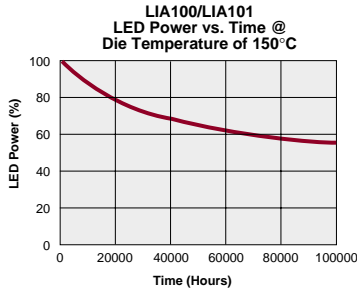
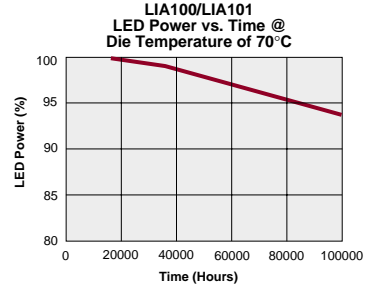
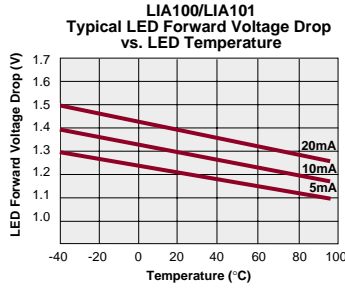
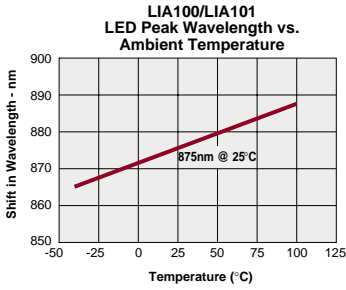

PERFORMANCE DATA

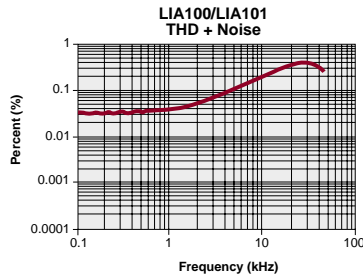
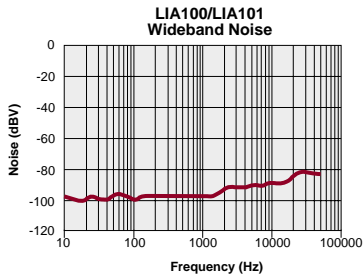

Cybergate™ Series Data Access Arrangement (DAA) Modules

CP Clare's newest and most exciting integrated solution has come to life in the Cybergate Series. By combining all of Clare's existing core technologies, we were able to provide a completely functional Data Access Arrangement (DAA) in a single 1.07" x 1.07" x 0.4" plastic module. The Cybergate products include surge protection, transient protection zeners, ring detection,

hookswitch circuitry, gyrator circuitry (for impedance balancing) and a transformer. Available options also include loop current detection and Caller ID pinout. This already impressive line of modular offerings gives the design engineer many different features to choose from when considering their DAA design plans.

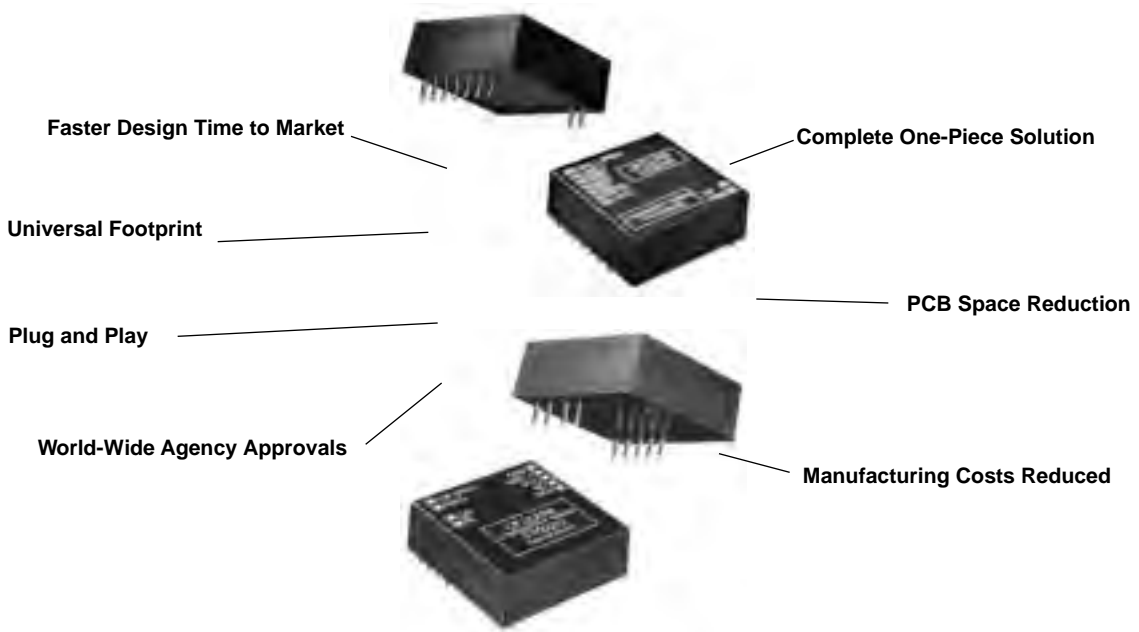

Cybergate™ Series Data Access Arrangement (DAA) Modules

Part Number	CYG20XX	CYG21XX	CYG22XX	CYG2911	Units
Speed	28.8	28.8	28.8	28.8	kbps
Hookswitch Resistance	15	35	15	15	Ω
Hookswitch Power Source	5	5	5	5	V
DC Loop Current	20-120	20-120	20-120	20-120	mA
Return Loss (Typ)	25	25	40	25	dB
THD	0.01	0.01	0.01	0.01	%

ORDERING INFORMATION

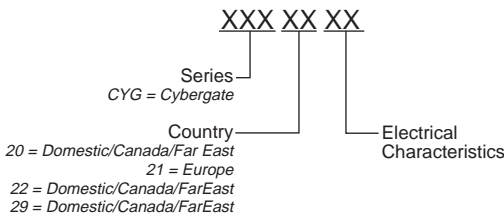

CYG2000/CYG2001/CYG2010/CYG2011/CYG2020/CYG2021/CYG2030/CYG2031



DESCRIPTION

The CYG2000/2001/2010/2011/2020/2021/2030/2031 are Data Access Arrangement (DAA) modules featuring a 350V, 120mA, 15Ω relay used for hookswitch, optocoupler with minimum CTR of 33% for ring detection, and a low distortion transformer with 28.8kbps capabilities.

FEATURES

- Low distortion transformer signal coupling (0.01% max)
- Complete ring detector circuit
- Low power hookswitch
- Electronic inductor/gyrator circuit
- Surge protection
- Transient protection zeners
- Half- (20X0) or Full- (20X1) Wave Detection
- V.32 bis /V.34 compatible
- FCC Compatible
- Compatible with U.S. and Canadian dial up phone lines
- Supports leased-line operation
- PC board mountable

APPLICATIONS

- Modems
- Fax machines
- Remote data acquisition
- Security systems
- Voice mail systems
- PC motherboard
- Computer telephony
- Process control
- Medical
- PBX
- Direct broadcast satellite

APPROVALS

- UL recognized file #: E174201

RATINGS (@ 25° C)

Parameter	Min	Typ	Max	Units
Isolation Voltage	-	-	1000	V _{RMS}
Operational Temperature	0	-	70	°C
Storage Temperature	0	-	70	°C
Relative Humidity (Non-Condensing)	10	-	85	%
Soldering Temperature	-	-	260	°C
Tip/Ring (5, 6) Load current (continuous)	-	-	120	mA
Hookswitch LED Drive Current	-	-	50	mA
Hookswitch LED Reverse Voltage	-	-	5	V
Ring Detect Phototransistor Voltage V _{CC}	-	-	20	V

Note: For Mechanical Dimensions See Pages 396-401

www.cpclare.com

SPECIFICATIONS

PARAMETERS	CONDITIONS	MIN	TYP	MAX	UNITS
DC Electrical Characteristics					
On-Hook Impedance	@100VDC across pins 10,11 (R,T), per FCC 68.312	10	-	-	MΩ
Off-Hook Line Leakage Current	@100VDC across pins 10,11 (R,T), per FCC 68.312	-	-	10	μA
Hookswitch Resistance	-	-	-	15	Ω
Off-Hook Supply Current	@+5V, V _{cc}	7	8	9	mA
Hookswitch Power Source, Pin 8	-	4.75	5.0	20 ¹	V
DC Loop Current	-	20	-	120	mA
AC Signal Path Electrical Characteristics					
Return Loss	300-3500Hz	18	25	-	dB
Insertion Loss	300-3500Hz	-	-	-	-
Transmit	Test Circuit 1	-	-	7	dB
Receive	Test Circuit 2	-	-	7	dB
Frequency Response	300-3500Hz	-0.25	-	+0.25	dB
Longitudinal Balance					
On-Hook	Per FCC 68.310	60	-	-	dB
Off-Hook	Per FCC 68.310	40	-	-	dB
DC Loop Current	-	20	-	120	mA
Total Harmonic Distortion	@600Hz and -10dBm	-	-	0.01	%
Secondary Load Impedance	Line 1 and Line 2	-	294	-	Ω
Primary Source Impedance	Tip and Ring	-	600	-	Ω
Ring Detection Circuit Characteristics					
Ringing Voltage Detection Range	-	20	-	150	V _{RMS}
Ringing Frequency Detection Range	-	15	-	70	Hz
Ringer Equivalence Number	-	-	0.8B	-	-
RING (Pin 9) Output Voltage (Pulsed)	V _{cc} @+5V	-	-	-	-
Logic '0', Ring present		-	-	0.8	V
Logic '1', Ring not present		-	-	V _{cc}	V
Surge, Transient, and Isolation Characteristics					
Surge Protection Voltage Tip and Ring (Pins 11,10)	-	-	-	300	-
Transient Voltage Protection on Line 1 and Line 2 (Pins 1,2)	-	-5	-	+5	V
Isolation Voltage (Pins 1,2,7,8,9,17,18 to10,11,13,14)	Per FCC 68.302	-	-	1000	V _{RMS}
Loop Detection Characteristics (CYG2010/CYG2011/CYG2030/CYG2031)					
Loop Current Detection Threshold	Internal optocoupler with 2.2K Pull-up resistor	9	10	11	mA

¹ V_{cc} = 20V max due to V_{ceo} = 20V.

Note: For Mechanical Dimensions See Pages 396-401

TEST CIRCUITS

1. CYG20XX Transmit Insertion Loss

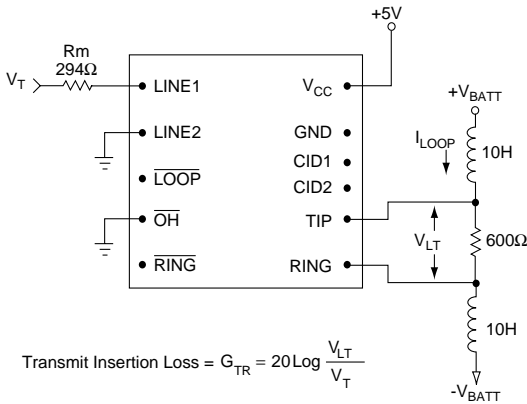

2. CYG20XX Receive Insertion Loss

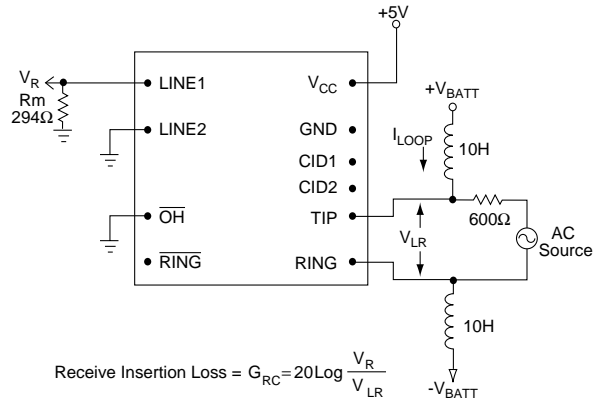

**CYG2020/2021/2030/2031
Caller ID Connections**

Pins 13 & 14 should be connected to a 1-Form-A solid state relay (CP Clare LCA110), as follows:

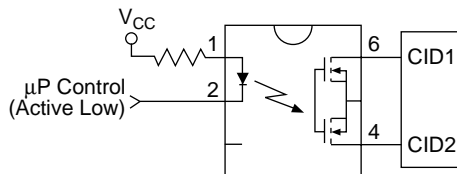

Note: For Mechanical Dimensions See Pages 396-401

PACKAGE PINOUTS

CYG2000/CYG2001

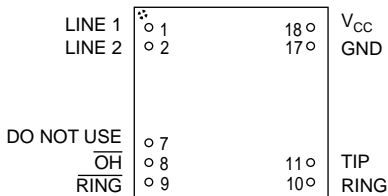

Top View

CYG2010/CYG2011

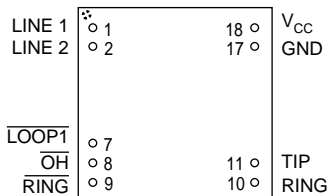

Top View

CYG2020/CYG2021

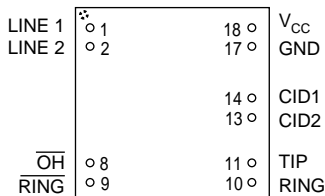

Top View

CYG2030/CYG2031

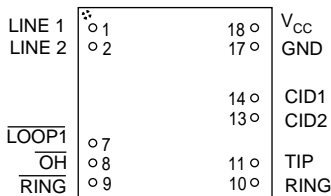

Top View

CYG20XX Pinouts & Definitions

PIN#	I/O	Name	Function
1	I/O	LINE1	Transformer isolated audio signal coupling path for the telephone line.
2	I/O	LINE2	Transformer isolated audio signal coupling path for the telephone line.
7	I	LOOP1	When system is off-hook ($\overline{\text{OH}}$ driven LOW) $\overline{\text{LOOP1}}$ is driven LOW continuously on CYG2010/2011/2030/2031 devices.
		N/C	Keying pin for CYG2000/CYG2001, do not use.
8	I	$\overline{\text{OH}}$	Driving this pin LOW asserts the off-hook condition. The hookswitch LED is current limited by an internal 470Ω resistor.
9	O	$\overline{\text{RING}}$	Active LOW indicates an incoming ring signal. This is pulsed LOW by the AC ring signal at the ring frequency from 15-40Hz.
10	I/O	RING	Connection to telephone line Ring conductor.
11	I/O	TIP	Connection to telephone line Tip conductor.
13	O	CID2	Caller ID connection on CYG2020/2021/2030/2031. CID1/CID2 connect to an external 1-Form-A solid state relay (CP Clare LCA110). When the SSR is closed (connecting CID1 to CID2) Caller ID information is presented to LINE1/LINE2 after the first telephone ring burst.
14	O	CID1	Caller ID connection. See CID2 above.
17	I	GND	Connected to host system ground.
18	I	V_{CC}	Provides power to the hookswitch LED. Typically +5V for ≈ 8mA LED current. LED is current limited by an internal 470Ω resistor. V_{CC} should not exceed 20V due to optocoupler $V_{\text{CEO}}=20\text{V}$ max.

Note: For Mechanical Dimensions See Pages 396-401

CYG2000/CYG2001/CYG2010/CYG2011/CYG2020/CYG2021/CYG2030/CYG2031

TYPICAL APPLICATION

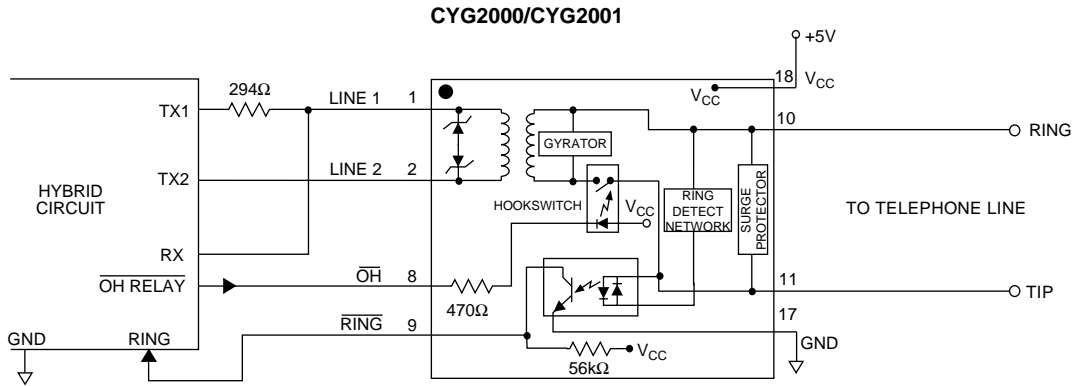

FUNCTIONAL BLOCK DIAGRAMS

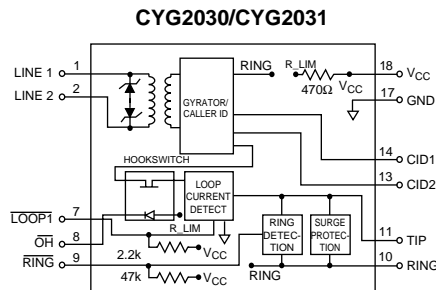
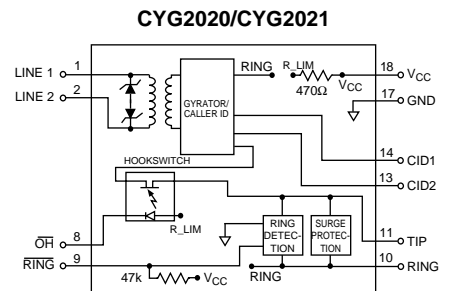
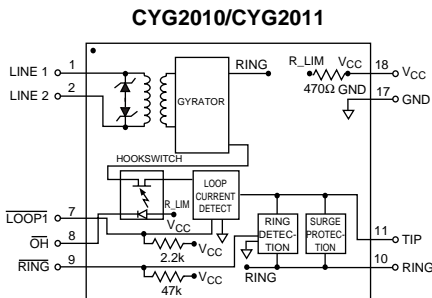

Note: For Mechanical Dimensions See Pages 396-401



DESCRIPTION

CP Clare's CYG21XX Series DAA modules provide a complete telephone line interface circuit in a small 1.07" x 1.07" x 0.4" package. The modules provide a fast and cost effective solution for designs that require an interface to the telephone line. The CYG2100 is designed to meet PTT and safety regulations in 13 countries.

The CYG2110 and CYG2120 are designed to meet PTT regulations in France and Spain, respectively.

FEATURES

- Low distortion transformer signal coupling (0.01% max)
- Complete ring detector circuit
- Low power hookswitch
- Electronic inductor/gyrator circuit
- Surge protection
- V.32 bis /V.34 compatible
- PTT and safety regulations in 15 countries
- PC board mountable
- FCC Compatible

APPLICATIONS

- Home medical devices
- Plant monitoring equipment
- Security/alarm systems
- Utility meters
- Modems
- Voicemail systems
- Vending machines
- Elevator control boxes
- Network routers
- PBX Systems
- PC mother boards
- Telephony applications
- Digital telephone answering machines

APPROVALS

- UL recognized file #: E174201
- BSI certified:
 - BS EN 60950: 1992 Certificate # 8123
- BABT recognized; listing pending

RATINGS (@ 25° C)

Parameter	Min	Typ	Max	Units
Isolation Voltage	-	-	1500	V _{RMS}
Operational Temperature	0	-	70	°C
Storage Temperature	0	-	100	°C
Relative Humidity (Non-Condensing)	10	-	85	%
Soldering Temperature	-	-	260	°C
Tip/Ring Load Current (continuous)	-	-	120	mA
Hookswitch LED Drive Current	-	-	50	mA
Hookswitch LED Reverse Voltage	-	-	5	V
Ring Detect Phototransistor Voltage V _{CC}	-	-	20	V

Note: For Mechanical Dimensions See Pages 396-401

SPECIFICATIONS

PARAMETERS	CONDITIONS	MIN	TYP	MAX	UNITS
DC Electrical Characteristics					
On-Hook Impedance	@100VDC across pins 5,6 (R,T)	10	-	-	MΩ
Off-Hook Line Leakage Current	@100VDC across pins 5,6 (R,T)	-	-	10	μA
Hookswitch Resistance	-	-	-	35	Ω
Off-Hook Relay Supply Current	@ V _{cc} =5V	7	8	9	mA
Hookswitch Power Source	-	4.75	5.0	20 ¹	V
DC Loop Current	-	5	-	120	mA
Mute Relay Supply Current	@ V _{cc} =5V	7	8	9	mA
AC Signal Path Electrical Characteristics					
Return Loss	300-3500Hz	14	25	-	dB
Insertion Loss					
Transmit	Test Circuit 1	-	-	7	dB
Receive	Test Circuit 2	-	-	7	dB
Frequency Response	300-3500Hz	-0.25	-	+0.25	dB
Longitudinal Balance					
On-Hook	-	60	-	-	dB
Off-Hook	-	40	-	-	dB
Total Harmonic Distortion	@350Hz and -10dBm	-	-	0.01	%
Secondary Load Impedance	Line 1 and Line 2	-	100	-	Ω
Primary Source Impedance	Tip and Ring	-	600	-	Ω
Ring Detection Circuit Characteristics					
Ringing Voltage Detection Range CYG2100, CYG2110 CTG2120	20-150-V _{RMS}	29 28	- -	150 15	V _{RMS} V _{RMS}
Ringing Frequency Detection Range	50-70Hz	15	-	70	Hz
Ringer Impedance	25Hz	-	18	-	KΩ
RING Output Voltage (Pulsed) Logic '0', Ring present Logic '1', Ring not present	V _{cc} @+5V	- -	- -	0.8 V _{cc}	V V
Surge, Transient, and Isolation Characteristics					
Surge Protection Voltage Tip and Ring	-	-	-	300	V
Isolation Voltage (Pins 1-7 to 10-11)	60 Seconds	-	-	1500	V _{RMS}

¹ V_{cc}= 20V max due to V_{CEO}= 20V.

TEST CIRCUITS

1. CYG21XX Transmit Insertion Loss

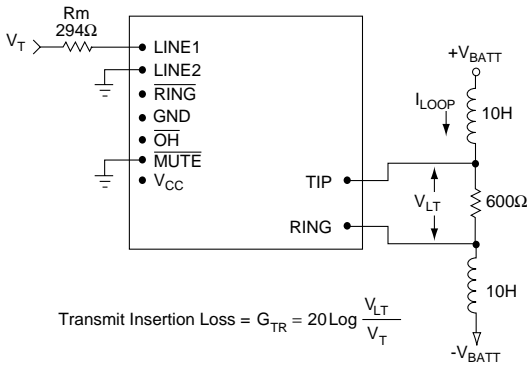

2. CYG21XX Receive Insertion Loss

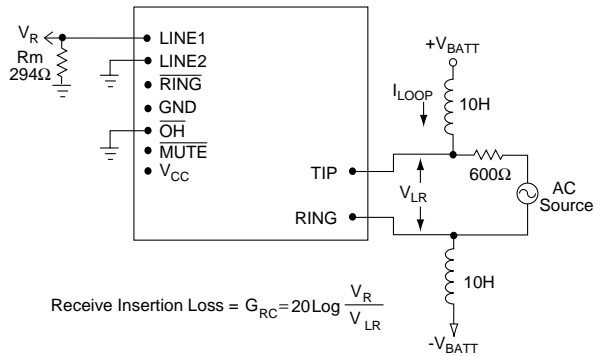

PACKAGE PINOUTS

CYG21XX

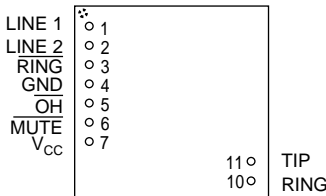

Top View

CYG21XX Pinouts & Definitions

PIN#	I/O	Name	Function
1	I/O	LINE1	Transformer isolated audio signal coupling path for the telephone line.
2	I/O	LINE2	Transformer isolated audio signal coupling path for the telephone line.
3	O	<u>RING</u>	Active LOW indicates an incoming ring signal. This is pulsed LOW by the AC ring signal at the ring frequency from 15-40Hz.
4	I	GND	Connected to host system ground.
5	I	<u>OH</u>	Driving this pin LOW asserts the off-hook condition. The hookswitch LED is current limited by an internal 470Ω resistor.
6	I	<u>MUTE</u>	Driving this pin LOW activates the mute relay for pulse dialing. The mute control is activated on or slightly before (50ms max.) the start of the first dial pulse, then kept active until the end (50ms max.) of the last dial pulse. The mute relay LED is current limited by an internal 470Ω resistor.
7	I	V _{CC}	Provides power to the hookswitch LED. Typically +5V for ≈ 8mA LED current. LED is current limited by an internal 470Ω resistor. V _{CC} should not exceed 20V due to optocoupler V _{CEO} =20V max.
11	I/O	RING	Connection to telephone line Ring conductor.
10	I/O	TIP	Connection to telephone line Tip conductor.

Note: For Mechanical Dimensions See Pages 396-401

TYPICAL APPLICATION

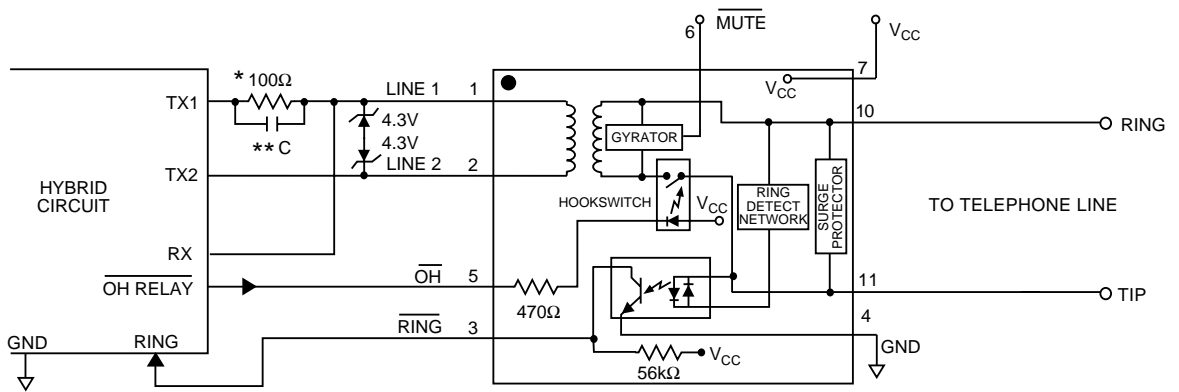

* UK/Sweden = 350Ω All other countries = 100Ω

** Installed for German/Swiss DAA Module

Note: For Mechanical Dimensions See Pages 396-401

www.cpclare.com



DESCRIPTION

CP Clare's Cybergate™ 22XX Series DAA module provides a complete telephone line interface circuit, including a 2-4 wire converter for transmit and receive signal separation in a small 1.07" x 1.07" x 0.4" package. The module provides a fast and cost effective solution for designs that require an interface to the telephone line. The module is designed to meet FCC part 68 requirements thus providing a low risk design solution.

FEATURES

- Low distortion transformer signal coupling (0.01% max)
- Complete ring detector circuit
- Low power hookswitch
- Electronic inductor/gyrator circuit
- Solid state surge protection
- Transient protection zeners
- Complete hybrid circuit (2-4 wire converter) included
- Compatible with all modem chip sets
- V.32 bis/V.34 compatible

APPLICATIONS

- Modems
- Fax machines
- Remote data acquisition
- Security systems
- Voice mail systems
- PC motherboard
- Computer telephony
- Process control
- Medical
- PBX
- Direct broadcast satellite

APPROVALS

- U.L. recognized file #: E174201

RATINGS (@ 25° C)

Parameter	Min	Typ	Max	Units
Isolation Voltage	-	-	1000	V _{RMS}
Operational Temperature	0	-	70	°C
Storage Temperature	0	-	100	°C
Relative Humidity (Non-Condensing)	10	-	85	%
Soldering Temperature	-	-	260	°C
Tip/Ring Load Current (continuous)	-	-	120	mA
Hookswitch LED Drive Current	-	-	50	mA
Hookswitch LED Reverse Voltage	-	-	5	V
Ring Detect Phototransistor Voltage V _{cc}	-	-	20	V

Note: For Mechanical Dimensions See Pages 396-401

SPECIFICATIONS

PARAMETERS	CONDITIONS	MIN	TYP	MAX	UNITS
DC Electrical Characteristics					
On-Hook Impedance 2,1 (R,T) per FCC 68.312	@100V V_{DC} across pins 1,2	10	-	-	M Ω
Off-Hook Line Leakage Current 2,1 (R,T) per FCC 68.312	@100V V_{DC} across pins 1,2	-	-	10	μ A
Power Supply Current @ V_{CC}	$V_{CC}=5V$	4	5	6	mA
Hookswitch Control Current @ (OH)	@ $V_{OH}=2.4V$	3.5	4.1	5.0	mA
	@ $V_{OH}=5.0V$	11.8	12.4	13	mA
Hookswitch Control Voltage	Off-Hook	2.0	3.0	20	V
	On-Hook	-	0.2	0.5	V
AC Signal Path Electrical Characteristics					
Return Loss	600 Ω , 1800Hz	39	40	-	dB
Insertion Loss	600 Ω , 1800Hz				
	Test Circuit 1	6.0	6.5	7	dB
Receive	Test Circuit 2	-1.0	0	+1.0	dB
Frequency Response	300-3500Hz	-0.25	-	+0.25	dB
Longitudinal Balance	On-Hook	60	-	-	dB
	Off-Hook	40	-	-	dB
Transhybrid Loss	600 Ω , 1800Hz	-	-32	-10	dB
Total Harmonic Distortion	600 Ω , 1800Hz	-	-	-80	dB
DC Loop Current	-	20	-	120	mA
Ring Detection Circuit Characteristics					
Ring Voltage Detection Range	-	20	-	150	V_{RMS}
Ring Frequency Detection Range	-	15	-	70	Hz
Ringer Equivalence Number	-	-	0.8B	-	-
RING (Pin 5) Output Voltage (Pulsed)	$V_{CC}=+5V$	Logic '0', Ring present	-	0.8	V
		Logic '1', Ring not present	-	V_{CC}	V
Surge and Isolation Characteristics					
Surge Protection Voltage Tip and Ring (Pins 1,2)	-	-	-	300	V
Isolation Voltage (Pins 18,17,16,15,14,5,4,to1,2)	Per FCC 68.302	-	-	1000	V_{RMS}

Note: For Mechanical Dimensions See Pages 396-401

www.cpclare.com

TEST CIRCUITS

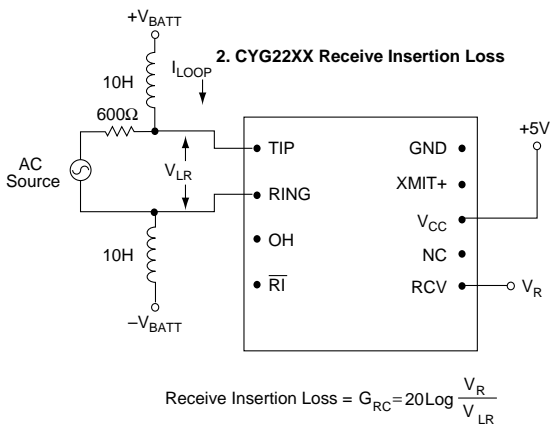
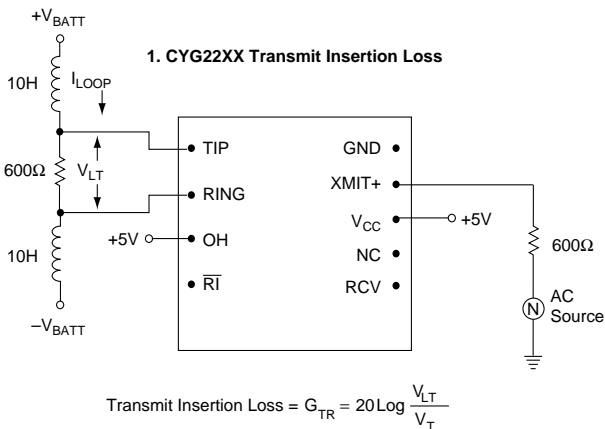

PACKAGE PINOUT

CYG22XX

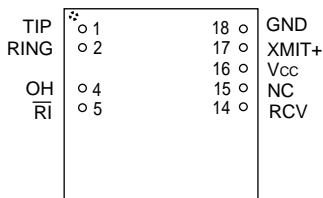

Top View

CYG22XX Pinouts & Definitions

PIN#	Name	Function
1	TIP	Connection to telephone line Tip connected through an external fuse.
2	RING	Connection to telephone line Ring conductor.
4	OH	Driving this pin high asserts the off-hook condition. The hookswitch LED is current limited by an internal 300Ω resistor.
5	RI	Active LOW indicates an incoming ring signal. This is pulsed LOW by the AC ring signal and is not a steady state LOW during ringing.
14	RCV	Provides the analog output signal from the 2-4 wire converter of the CYG22XX. RCV uses a 2.5 volt reference signal and therefore must be capacitively coupled to host equipment which uses a ground reference.
15	NC	No connection.
16	V _{CC}	Provides power to the CYG22XX. Typically +5V, V _{CC} should not exceed 20V due to optocoupler V _{CEO} =20V max.
17	XMIT+	Provides the analog input signal from the 2-4 wire converter of the CYG22XX. XMIT+ uses a 2.5 volt reference signal and therefore must be capacitively coupled to host equipment which uses a ground reference.
18	GND	Connection to host system ground.

Note: For Mechanical Dimensions See Pages 396-401

FUNCTIONAL BLOCK DIAGRAM

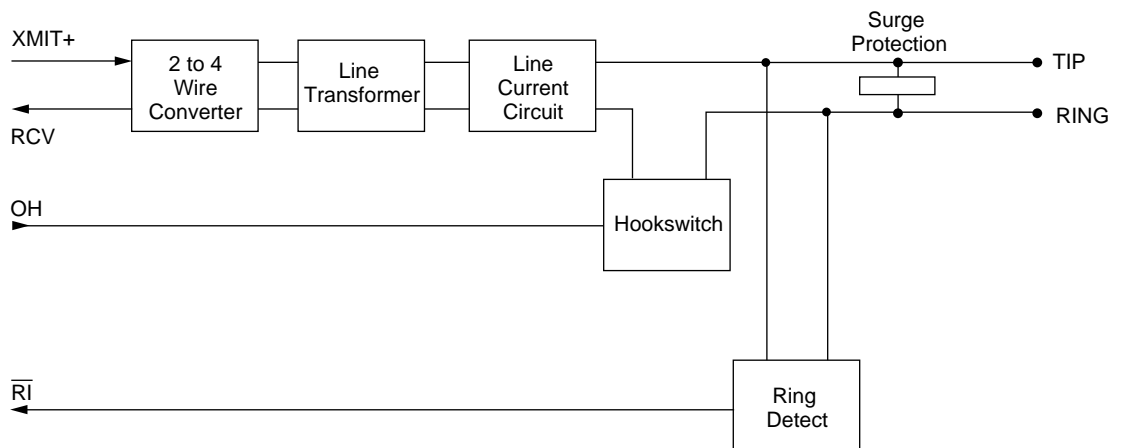

Note: For Mechanical Dimensions See Pages 396-401

www.cpcclare.com



DESCRIPTION

The CYG2911 is a Data Access Arrangement (DAA) module providing a complete telephone line interface circuit in a small 1.07" x 1.07" x 0.4" plastic package. This module incorporates a circuit which signals HIGH when another phone in parallel has been taken off-hook when the CYG2911 is off-hook. This feature is important for cable TV set-top boxes and direct broadcast satellite units which must hang-up (go on-hook) when a consumer needs the phone line to place a 911 or emergency call. The module is designed to meet FCC Part 68 requirements thus providing a low-risk design solution.

FEATURES

- Transformer signal coupling
- Complete ring detector circuit
- Low power hookswitch
- Electronic inductor/gyrator circuit
- Surge protection
- Caller ID pinout to external relay (optional)
- Transient protection zeners
- V.32 compatible
- FCC Compatible
- PC board mountable
- Parallel telephone off-hook detection

APPLICATIONS

- Home medical devices
- Plant monitoring equipment
- Security/alarm systems
- Utility meters
- Network routers
- PBX systems
- Telephony applications
- Set top boxes

APPROVALS

- UL 1950/UL1459 pending
- Compatible with U.S. and Canadian phone lines

RATINGS (@ 25° C)

Parameter	Min	Typ	Max	Units
Isolation Voltage	-		1000	V _{RMS}
Operational Temperature	0		+70	°C
Storage Temperature	0	-	+100	°C
Relative Humidity (Non-Condensing)	10	-	85	%
Soldering Temperature	-	-	+260	°C
Tip/Ring (5, 6) Load Current (continuous)	-	-	120	mA
Hookswitch LED Drive Current	-	-	50	mA
Hookswitch LED Reverse Voltage	-	-	5	V
Ring Detect Phototransistor Voltage V _{CC}	-	-	20	V

Note: For Mechanical Dimensions See Pages 396-401

SPECIFICATIONS

PARAMETERS	CONDITIONS	MIN	TYP	MAX	UNITS
DC Electrical Characteristics					
On-Hook Impedance	@100VDC across pins 10,11 (R,T), per FCC 68.312	10	-	-	MΩ
Off-Hook Line Leakage Current	@100VDC across pins 10,11 (R,T), per FCC 68.312	-	-	10	μA
Hookswitch Resistance	-	-	-	15	Ω
Off-Hook Supply Current	@+5V, V _{CC}	7	8	9	mA
Hookswitch Power Source, Pin 8	-	4.75	5.0	20 ¹	V
DC Loop Current	-	20	-	120	mA
AC Signal Path Electrical Characteristics					
Return Loss	300-3500Hz	18	25	-	dB
Insertion Loss					
Transmit	Test Circuit 1	-	-	9	dB
Receive	Test Circuit 2	-	-	9	dB
Frequency Response	300-3500Hz	-0.25	-	+0.25	dB
Longitudinal Balance					
On-Hook	Per FCC 68.310	60	-	-	dB
Off-Hook	Per FCC 68.310	40	-	-	dB
DC Loop Current	-	20	-	120	mA
Total Harmonic Distortion + N	@600Hz and -10dBm	-	-45	-	dBm
Secondary Load Impedance	Line 1 and Line 2	-	294	-	Ω
Primary Source Impedance	Tip and Ring	-	600	-	Ω
Ring Detection Circuit Characteristics					
Ringing Voltage Detection Range	-	20	-	150	V _{RMS}
Ringing Frequency Detection Range	-	15	-	70	Hz
Ringer Equivalence Number	-	-	0.8B	-	
RING (Pin 9) Output Voltage (Pulsed)	V _{CC} @+5V				
Logic '0', Ring present		-	-	0.8	V
Logic '1', Ring not present		-	-	V _{CC}	V
Surge, Transient, and Isolation Characteristics					
Surge Protection Voltage Tip and Ring (Pins 11,10)	-	-	-	300	
Transient Voltage Protection on Line 1 and Line 2 (Pins 1,2)	-	-5	-	+5	V
Isolation Voltage (Pins 1,2,7,8,9,17,18 to 10,11,13,14)	Per FCC 68.302	-	-	1000	V _{RMS}
911 Detection Characteristics (Pin 7)					
Pulse Voltage					
External phone off-hook	-	2.4	-	V _{CC}	V
External phone on-hook	-	-	-	0.8	V
Pulse Width	Telephone DCR 200Ω	20	40	60	mS
Internal pull-up resistor	-	-	200K	-	Ω

¹ V_{CC}=20V max due to V_{CEO}=20V.

Note: For Mechanical Dimensions See Pages 396-401

www.cpclare.com

PACKAGE PINOUT

CYG2911

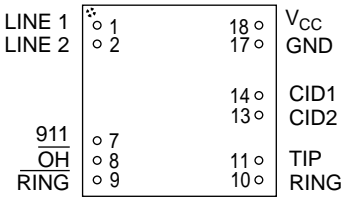

Top View

CYG2911 Pinouts & Definitions

PIN#	I/O	Name	Function
1	I/O	LINE1	Transformer isolated audio signal coupling path for the telephone line.
2	I/O	LINE2	Transformer isolated audio signal coupling path for the telephone line.
7	O	911	Signals HIGH for 20-60ms when the CYG2911 is off-hook and another phone goes off-hook. Glitches may appear on this pin when the CYG2911 first goes off-hook, and should be ignored for a minimum of 200ms.
8	I	OH	Driving this pin LOW asserts the off-hook condition. The hookswitch LED is current limited by an internal 470Ω resistor.
9	O	RING	Active LOW indicates an incoming ring signal. This is pulsed LOW by the AC ring signal at the ring frequency from 15-40Hz.
10	I/O	RING	Connection to telephone line Ring conductor.
11	I/O	TIP	Connection to telephone line Tip conductor.
13	O	CID2	Caller ID connection. CID1/CID2 connect to an external 1-Form-A solid state relay (CP Clare LCA110). When the SSR is closed (connecting CID1 to CID2), Caller ID information is presented to LINE1/LINE2 after the first telephone ring burst.
14	O	CID1	Caller ID connection. See CID2 above.
17	I	GND	Connected to host system ground.
18	I	V _{CC}	Provides power to the hookswitch LED. Typically +5V for ≈ 8mA LED current. LED is current limited by an internal 470Ω resistor. V _{CC} should not exceed 20V due to optocoupler V _{CEO} = 20V max.

CYG2911

Caller ID Connections

Pins 13 & 14 should be connected to a 1-Form-A relay (CP Clare LCA110), as follows:

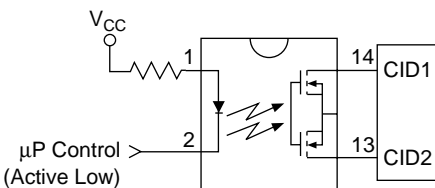

FUNCTIONAL BLOCK DIAGRAM

CYG2911

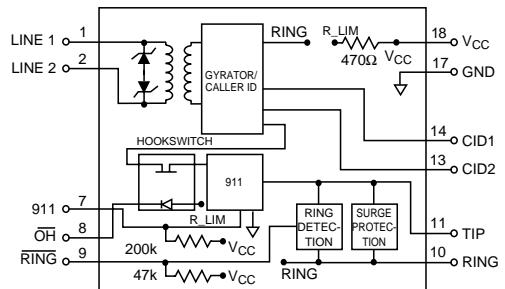

Note: For Mechanical Dimensions See Pages 396-401

Solid State Current Sensors



CP Clare's LDA Series of solid state current sensors provide an optically isolated means of switching control circuits. Applications include Telecom, Industrial Control, and instrumentation circuits, where electrical isolation of control circuitry is crucial. Each package contains one or two phototransistors which are optically coupled with LEDs. Shunt resistors can be used to adjust the threshold currents required to activate the output circuitry. The LDA contains sensors which allow for either AC or DC input circuits and single transistor or Darlington transistor outputs.

Solid State Current Sensors

Part Number	LDA100	LDA101	LDA110	LDA111	LDA200	LDA201	LDA210	LDA211	Units
Package Type	6 Pin DIP	6 Pin DIP	6 Pin DIP	6 Pin DIP	8 Pin DIP	8 Pin DIP	8 Pin DIP	8 Pin DIP	-
Current Transfer Ratio (Typ.)	100	100	1000	1000	100	100	1000	1000	%
Breakdown Voltage (min)	20	20	20	20	20	20	20	20	V
Input Control Current (I _c)	6	6	2	2	6	6	2	2	mA
Saturation Voltage	0.5	0.5	0.8	0.8	0.5	0.5	0.8	0.8	V

ORDERING INFORMATION

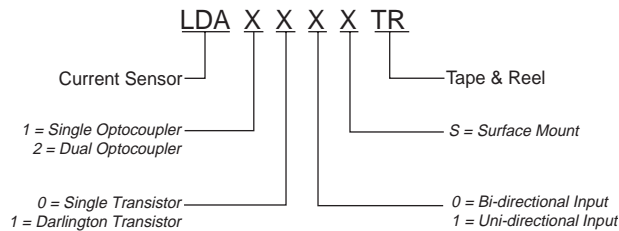

SOLID STATE CURRENT SENSORS

LDA100/LDA101/LDA110/LDA111



DESCRIPTION

The LDA100/LDA101/LDA110/LDA111 are optocouplers with a single or darlington transistor outputs. A bi-directional or uni-directional input is available depending on which model you choose. Current transfer ratios range from 33% to 1000%.

FEATURES

- AC and DC Input Versions Available
- Small 6 Pin DIP Package
- 100mA Continuous Load Rating
- 3750 V_{RMS} Input/Output Isolation
- Machine Insertable, Wave Solderable
- Surface Mount and Tape Reel Versions Available

APPROVALS

- UL Recognized: File Number E76270
- CSA Certified: File Number LR 43639-10
- BSI Certified:
 - BS EN 60950:1992 (BS7002:1992) Certificate #:7344
 - BS EN 41003:1993 Certificate #:7344

OPTIONS / SUFFIXES

- S: Surface Mount Package
- TR: Tape & Reel

APPLICATIONS

- Telecom Switching
- Tip/Ring Circuits
- Modem Switching (Laptop, Notebook, Pocket Size)
- Loop Detect
- Ring Detect
- Current Sensing

RATINGS (@ 25° C)

Parameter	Min	Typ	Max	Units
Input Power Dissipation	-	-	150 ¹	mW
Input Control Current	-	-	100	mA
Peak (10ms)	-	-	1	A
Reverse Input Voltage	-	-	5	V
Phototransistor	-	-	150 ²	mW
Power Dissipation	-	-	-	-
Total Package Dissipation	-	-	800 ³	mW
Capacitance	-	-	-	-
Input to Output	-	3	-	pF
Isolation Voltage	-	-	-	-
Input to Output	3750	-	-	V _{RMS}
Operational Temperature	-40	-	+85	°C
Storage Temperature	-40	-	+125	°C
Soldering Temperature (10 Seconds Max.)	-	-	-	-
DIP Package	-	-	+260	°C
Surface Mount Package	-	-	+220	°C

¹ Derate Linearly 1.33 mw/°C

² Derate Linearly 2.0 mw/°C

³ Derate Linearly 1.67 mw/°C

Note: For Mechanical Dimensions See Pages 396-401

SPECIFICATIONS

PARAMETERS	CONDITIONS	SYMBOL	LDA100/LDA101			LDA110/LDA111			UNITS
			MIN	TYP	MAX	MIN	TYP	MAX	
Output Characteristics @ 25°C									
Phototransistor Blocking Voltage	$I_C=10\mu\text{A}$	BV_{CE0}	20	50	-	20	50	-	V
Phototransistor Output Current	$V_{CE}=5\text{V}, I_F=0\text{mA}$	I_{CE0}	-	50	500	-	50	500	nA
Saturation Voltage	$I_C=2\text{mA}, I_F=16\text{mA}$ $I_C=.15\text{mA}, I_F=.05\text{mA}$	V_{SAT}	-	0.3	0.5	-	-	-	V
			-	-	-	-	0.5	0.5	V
Current Transfer Ratio	$I_F=6\text{mA}, V_{CE}=0.5\text{V}$	CTR	33	100	-	300	1000	-	%
Output Capacitance	50V, f=1 MHz	C_{OUT}	-	3	-	-	3	-	pF
Input Characteristics @ 25°C									
Input Control Current	$I_C=2\text{mA}, V_{CE}=0.5\text{V}$	I_F	6	2	100	2	1	100	mA
Input Voltage Drop	$I_F=5\text{mA}$	V_F	0.9	1.2	1.4	0.9	1.2	1.4	V
Input Reverse Voltage (LDA101, LDA111)	-	V_R	-	-	5	-	-	5	V
Input Reverse Current (LDA101, LDA111)	$V_R=5\text{V}$	I_R	-	-	10	-	-	10	nA
Common Characteristics @ 25°C									
Input to Output Isolation	-	$V_{I/O}$	3750	-	-	3750	-	-	V_{RMS}

LDA100 Pinout

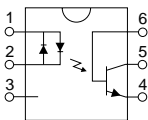

LDA101 Pinout

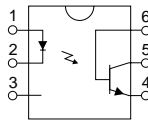

LDA110 Pinout

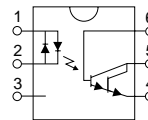

LDA111 Pinout

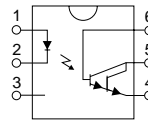

Note: For Mechanical Dimensions See Pages 396-401

PERFORMANCE DATA

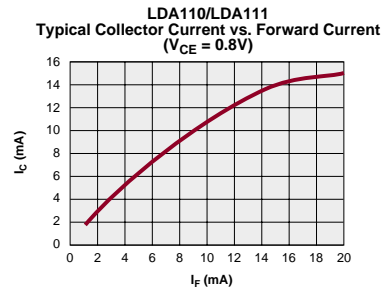
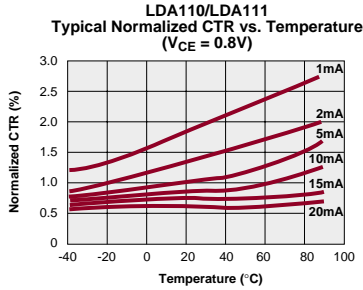
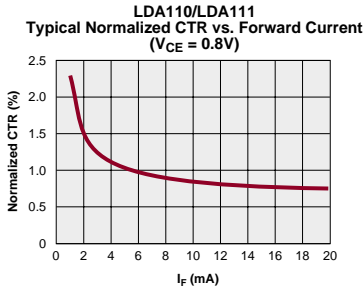
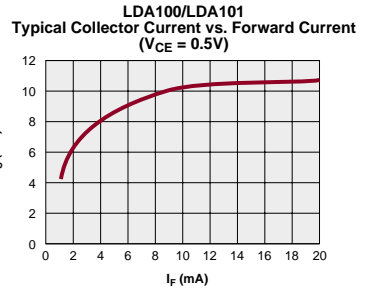
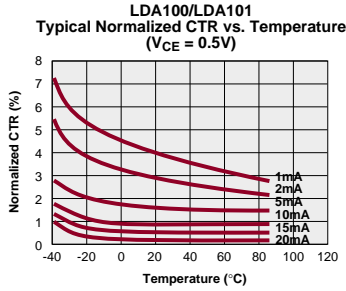
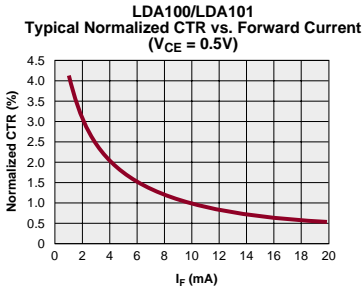



DESCRIPTION

The LDA200/LDA201/LDA210/LDA211 are dual optocouplers with a single phototransistor or darlington transistor outputs. A bi-directional or uni-directional input is available depending on which model you choose. Current transfer ratios range from 33% to 1000%.

FEATURES

- AC and DC Input Versions Available
- Small 8 Pin DIP Package
- 100mA Continuous Load Rating
- 3750 V_{RMS} Input/Output Isolation
- Machine Insertable, Wave Solderable
- Surface Mount and Tape Reel Versions Available

APPROVALS

- UL Recognized: File Number E76270
- CSA Certified: File Number LR 43639-10
- BSI Certified:
 - BS EN 60950:1992 (BS7002:1992)
Certificate #:7344
 - BS EN 41003:1993
Certificate #:7344

OPTIONS / SUFFIXES

- S: Surface Mount Package
- TR: Tape & Reel

APPLICATIONS

- Telecom Switching
- Tip/Ring Circuits
- Modem Switching (Laptop, Notebook, Pocket Size)
- Loop Detect
- Ring Detect
- Current Sensing

RATINGS (@ 25° C)

Parameter	Min	Typ	Max	Units
Input Power Dissipation	-	-	150 ¹	mW
Input Control Current	-	-	100	mA
Peak (10ms)	-	-	1	A
Reverse Input Voltage	-	-	5	V
Phototransistor	-	-	150 ²	mW
Power Dissipation	-	-	-	-
Total Package Dissipation	-	-	800 ³	mW
Capacitance	-	-	-	-
Input to Output	-	3	-	pF
Isolation Voltage	-	-	-	-
Input to Output	3750	-	-	V _{RMS}
Operational Temperature	-40	-	+85	°C
Storage Temperature	-40	-	+125	°C
Soldering Temperature (10 Seconds Max.)	-	-	-	-
DIP Package	-	-	+260	°C
Surface Mount Package	-	-	+220	°C

¹ Derate Linearly 1.33 mw/°C

² Derate Linearly 2.0 mw/°C

³ Derate Linearly 1.67 mw/°C

Note: For Mechanical Dimensions See Pages 396-401

SOLID STATE CURRENT SENSORS

LDA200/LDA201/LDA210/LDA211

SPECIFICATIONS

PARAMETERS	CONDITIONS	SYMBOL	LDA200/LDA201			LDA210/LDA211			UNITS
			MIN	TYP	MAX	MIN	TYP	MAX	
Output Characteristics @ 25°C									
Phototransistor Blocking Voltage	$I_C=10\mu A$	BV_{CEO}	20	50	-	20	50	-	V
Phototransistor Output Current	$V_{CE}=5V, I_F=0mA$	I_{CEO}	-	50	500	-	100	1000	nA
Saturation Voltage	$I_C=2mA, I_F=16mA$	V_{SAT}	-	0.3	0.5	-	-	-	V
	$I_C=.15mA, I_F=.05mA$	V_{SAT}	-	-	-	-	0.5	0.8	V
Current Transfer Ratio	$I_F=6mA, V_{CE}=0.5V$	CTR	33	100	-	300	1000	-	%
Output Capacitance	50V, f=1 MHz	C_{OUT}	-	3	-	-	3	-	pF
Input Characteristics @ 25°C									
Input Control Current	$I_C=2mA, V_{CE}=0.5V$	I_F	6	2	100	6	2	100	mA
Input Voltage Drop	$I_F=5mA$	V_F	0.9	1.2	1.4	0.9	1.2	1.4	V
Input Reverse Voltage (LDA201, LDA211)	-	V_R	-	-	5	-	-	5	V
Input Reverse Current (LDA201, LDA211)	$V_R=5V$	I_R	-	-	10	-	-	10	nA
Common Characteristics @ 25°C									
Input to Output Isolation	-	$V_{I/O}$	3750	-	-	3750	-	-	V_{RMS}

LDA200 Pinout

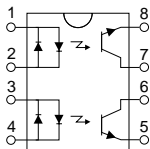

LDA201 Pinout

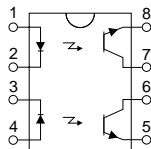

LDA210 Pinout

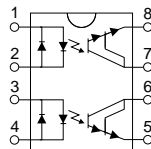

LDA211 Pinout

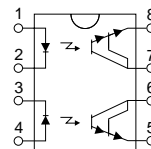

Note: For Mechanical Dimensions See Pages 396-401

PERFORMANCE DATA

LDA200/LDA201
Typical Normalized CTR vs. Forward Current
($V_{CE} = 0.5V$)

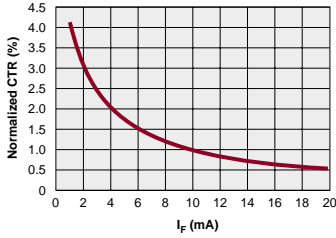

LDA200/LDA201
Typical Normalized CTR vs. Temperature
($V_{CE} = 0.5V$)

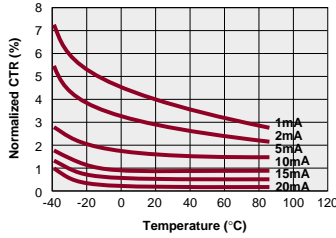

LDA200/LDA201
Typical Collector Current vs. Forward Current
($V_{CE} = 0.5V$)

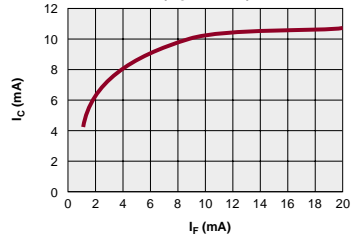

LDA210/LDA211
Typical Normalized CTR vs. Forward Current
($V_{CE} = 0.8V$)

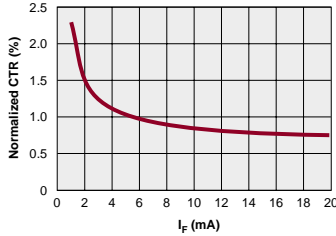

LDA210/LDA211
Typical Normalized CTR vs. Temperature
($V_{CE} = 0.8V$)

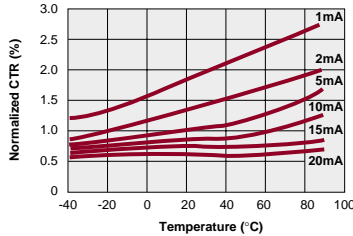

LDA210/LDA211
Typical Collector Current vs. Forward Current
($V_{CE} = 0.8V$)

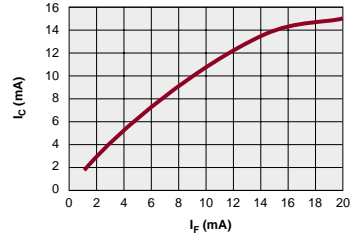

Hybrid Circuits



CP Clare's PD/PS/PM Series power switches employ patented waveguide coupling with dual power SCR outputs to produce an alternative to optocoupler and Triac circuits. Superior noise immunity complying with NEMA ICS 2-230 "showering arc" test is provided along with advanced thermally efficient package design. Long life and environmental integrity make these devices suitable to control a variety of AC circuits including heaters, motors, solenoids, larger relays and contactors.

CP Clare's FDA MOSFET driver couples infrared light emitting diodes with a pair of proprietary photovoltaic integrated circuits. In addition to providing voltage for turn-on of discrete MOSFETs, these patented ICs feature a gate-clamping circuit to provide fast turn-off. The FDA offers a significant reduction in drive circuit complexity, board-space, and cost over alternate techniques for isolated switching of MOSFETs. Used in conjunction with discrete MOSFETs, the FDA is ideal for use in programmable controls, process control, instrumentation and telecommunications, replacing TRIAC/driver, mechanical relays, and bipolar components.

Hybrid Circuits

Part Number	PD1201/PS1201	PD2401/PS2401	PD2601/PS2601	PM1204	PM1205	PM1206	Units
Package Type	DIP/SIP	DIP/SIP	DIP/SIP	6 Pin DIP	6 Pin DIP	6 Pin DIP	-
Peak Blocking Voltage	400	500	600	400	500	600	V
Load Current	1	1	1	0.5	0.5	0.5	A
Operating Frequency	20-500	20-500	20-500	20-500	20-500	20-500	Hz
Input Control Current	5	5	5	5	5	5	mA
Offstate Leakage Current	1	1	1	1	1	1	mA

Part Number	FDA215	Units
Package Type	8 Pin DIP	-
Open Circuit Voltage $I_{LED}=5mA$ (max)	8	V
Short Circuit Current $I_{LED}=5mA$	2.5	mA
Short Circuit Current $I_{LED}=25mA$	3.5	mA
Input Control Current (I_c)	2	mA

ORDERING INFORMATION

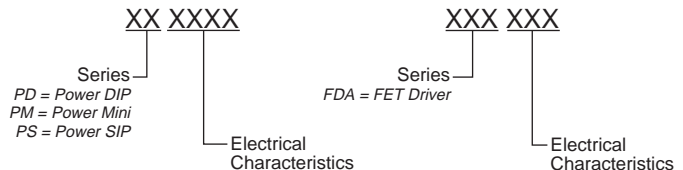



DESCRIPTION

The PD1201/PD2401/PD2601 are AC Solid State Switches utilizing dual power SCR outputs. These devices also include zero turn on circuitry and are available with a blocking voltage up to 600V.

FEATURES

- Load Current up to 1A
- Blocking Voltage to 600V
- 5mA Sensitivity
- Zero-Crossing Detection
- DC Control, AC Output
- Optically Isolated
- TTL and CMOS Compatible
- Low EMI and RFI Generation
- High Noise Immunity
- VDE compatible
- Machine Insertable, Wave Solderable

APPLICATIONS

- Programmable Control
- Process Control
- Power Control Panels
- Remote Switching
- Gas Pump Electronics
- Contractors
- Large Relays
- Solenoids
- Motors
- Heaters

APPROVALS

- UL recognized file #: E69938
- CSA certified file #: LR 43639-8

OPTIONS / SUFFIXES

- S: Surface Mount Package

RATINGS (@ 25° C)

Parameter	Min	Typ	Max	Units
Input Power Dissipation	-	-	150 ¹	mW
Input Control Current	-	-	50	mA
Peak (10ms)	-	-	1	A
Reverse Input Voltage	-	-	5	V
Total Package Dissipation				
PD	-	-	1600 ²	mW
Capacitance				
Input to Output	-	3	-	pF
Isolation Voltage				
Input to Output	3750	-	-	V _{RMS}
Operational Temperature	-40	-	+85	°C
Storage Temperature	-40	-	+125	°C
Soldering Temperature				
(10 Seconds Max.)				
DIP Package	-	-	+260	°C
Surface Mount Package	-	-	+220	°C

¹ Derate Linearly 1.33 mW/°C

² Derate Linearly 16.6 mW/°C

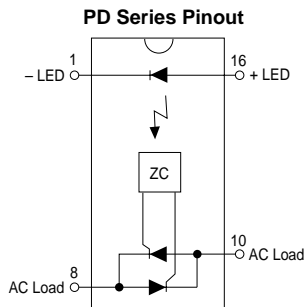

Note: For Mechanical Dimensions See Pages 396-401

SPECIFICATIONS

PARAMETERS	CONDITIONS	SYMBOL	PD1201			PD2401			PD2601			UNITS
			MIN	TYP	MAX	MIN	TYP	MAX	MIN	TYP	MAX	
Output Characteristics @ 25°C												
Peak Blocking Voltage	-	V_{DRM}	-	-	400	-	-	500	-	-	600	V
Load Current (Continuous)	$V_L=120-240V_{AC}$	I_L	0.005	-	1	0.005	-	1	0.005	-	1	A
Off State Leakage Current	V_{DRM}	I_{LEAK}	-	-	1	-	-	1	-	-	1	mA
On-State Voltage Drop	$I_L=1A$		-	-	1.2	-	-	1.2	-	-	1.2	V_{RMS}
Critical Rate of Rise	dv/dt		1000	1200	-	1000	1200	-	1000	1200	-	V/μS
Switching Speeds												
Turn-on	$I_F=5\text{ mA}$	T_{ON}	-	-	0.5	-	-	0.5	-	-	0.5	Cycles
Turn-off	$I_F=5\text{ mA}$	T_{OFF}	-	-	0.5	-	-	0.5	-	-	0.5	Cycles
Zero-Cross Turn-On Voltage	1st half cycle		-	2	5	-	2	5	-	2	5	V
	Sub. half cycle		-	-	1	-	-	1	-	-	1	V
Operating Frequency ¹	-		20	-	500	20	-	500	20	-	500	Hz
Load Power Factor for												
Guaranteed Turn-On ²	-	PF	0.25	-	-	0.25	-	-	0.25	-	-	-
Input Characteristics @ 25°C												
Input Control Current												
For Normal Environment	-	I_F	5	-	50	5	-	50	5	-	50	mA
For High Noise Environment	-	I_F	10	-	100	10	-	100	10	-	100	mA
Input Voltage Drop	$I_F=5\text{ mA}$	V_F	0.9	1.2	1.4	0.9	1.2	1.4	0.9	1.2	1.4	V
Input Drop-out Voltage	-		0.8	-	-	0.8	-	-	0.8	-	-	V
Reverse Input Current	$V_R=5V$	I_R	-	-	10	-	-	10	-	-	10	uA
Common Characteristics @ 25°C												
Input to Output Capacitance	-	$C_{I/O}$	-	-	3	-	-	3	-	-	3	V_{RMS}
Input to Output Isolation	-	$V_{I/O}$	3750	-	-	3750	-	-	3750	-	-	V_{RMS}

¹ Zero cross 1st 1/2 cycle @ <100Hz

² Snubber circuits may be required at low power factors.

Note: For Mechanical Dimensions See Pages 396-401

PERFORMANCE DATA

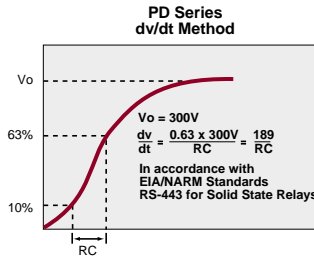
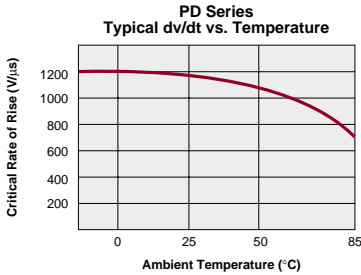
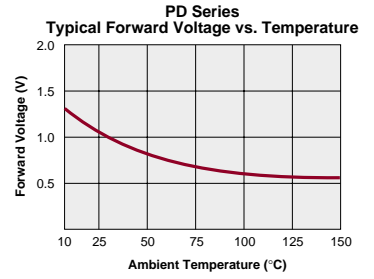
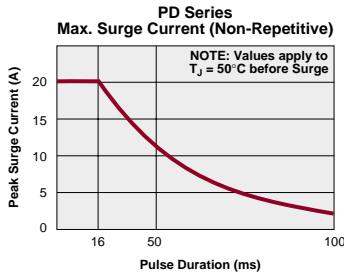
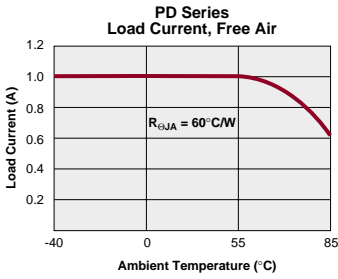

AC POWER SWITCH

PS1201/PS2401/PS2601

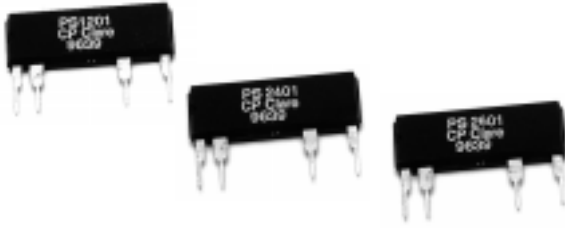

DESCRIPTION

The PS1201/PS2401/PS2601 are AC Solid State Switches utilizing dual power SCR outputs. These devices also include zero turn on circuitry and are available with a blocking voltage up to 600V.

FEATURES

- Load Current up to 3A with heat sink
- Blocking Voltages up to 600V
- 5mA Sensitivity
- Zero-Crossing Detection
- DC Control, AC Output
- Optically Isolated
- TTL and CMOS Compatible
- Low EMI and RFI Generation
- High Noise Immunity
- VDE compatible
- Machine Insertable, Wave Solderable

APPLICATIONS

- Programmable Control
- Process Control
- Power Control Panels
- Remote Switching
- Gas Pump Electronics
- Contractors
- Large Relays
- Solenoids
- Motors
- Heaters

APPROVALS

- UL recognized file #: E69938
- CSA certified file #: LR 43639-8

OPTIONS / SUFFIXES

- S: Surface Mount Package

PS Series Pinout

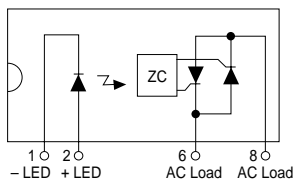

RATINGS (@ 25° C)

Parameter	Min	Typ	Max	Units
Input Power Dissipation	-	-	150 ¹	mW
Input Control Current	-	-	50	mA
Peak (10ms)	-	-	1	A
Reverse Input Voltage	-	-	5	V
Total Package Dissipation	-	-	1600 ²	mW
PS	-	-	-	-
Capacitance	-	-	-	-
Input to Output	-	3	-	pF
Isolation Voltage	-	-	-	-
Input to Output	3750	-	-	V _{RMS}
Operational Temperature	-40	-	+85	°C
Storage Temperature	-40	-	+125	°C
Soldering Temperature	-	-	-	-
(10 Seconds Max.)	-	-	-	-
DIP Package	-	-	+260	°C
Surface Mount Package	-	-	+220	°C

¹ Derate Linearly 1.33 mW/°C

² Derate Linearly 16.6 mW/°C

Note: For Mechanical Dimensions See Pages 396-401

SPECIFICATIONS

PARAMETERS	CONDITIONS	SYMBOL	PS1201			PS2401			PS2601			UNITS
			MIN	TYP	MAX	MIN	TYP	MAX	MIN	TYP	MAX	
Output Characteristics @ 25°C												
Peak Blocking Voltage	-	V_{DRM}	-	-	400	-	-	500	-	-	600	V
Load Current (Continuous)	$V_L=120-240V_{AC}$	I_L	0.005	-	1	0.005	-	1	0.005	-	1	A
Off State Leakage Current	V_{DRM}	I_{LEAK}	-	-	1	-	-	1	-	-	1	mA
On-State Voltage Drop	$I_L=1A$		-	-	1.2	-	-	1.2	-	-	1.2	V_{RMS}
Critical Rate of Rise	-	dv/dt	1000	1200	-	1000	1200	-	1000	1200	-	V/ μ S
Switching Speeds												
Turn-on	$I_F=5\text{ mA}$	T_{ON}	-	-	0.5	-	-	0.5	-	-	0.5	cycles
Turn-off	$I_F=5\text{ mA}$	T_{OFF}	-	-	0.5	-	-	0.5	-	-	0.5	cycles
Zero-Cross Turn-On Voltage	1st half cycle		-	2	5	-	2	5	-	2	5	V
	Sub. half cycle		-	-	1	-	-	1	-	-	1	V
Operating Frequency ¹	-		20	-	500	20	-	500	20	-	500	Hz
Load Power Factor for Guaranteed Turn-On ²	-	PF	0.25	-	-	0.25	-	-	0.25	-	-	-
Input Characteristics @ 25°C												
Input Control Current												
For Normal Environment	-	I_F	5	-	50	5	-	50	5	-	50	mA
For High Noise Environment	-	I_F	10	-	100	10	-	100	10	-	100	mA
Input Voltage Drop	$I_F=5\text{mA}$	V_F	0.9	1.2	1.4	0.9	1.2	1.4	0.9	1.2	1.4	V
Input Drop-out Voltage			0.8	-	-	0.8	-	-	0.8	-	-	V
Reverse Input Current	$V_R=5V$	I_R	-	-	10	-	-	10	-	-	10	μ A
Common Characteristics @ 25°C												
Input to Output Capacitance	-	$C_{I/O}$	-	-	3	-	-	3	-	-	3	V_{RMS}
Input to Output Isolation	-	$V_{I/O}$	3750	-	-	3750	-	-	3750	-	-	V_{RMS}

¹ Zero Cross 1st half cycle @ <100Hz² Snubber circuits may be required at low power factors.

Note: For Mechanical Dimensions See Pages 396-401

www.cpclare.com

PERFORMANCE DATA

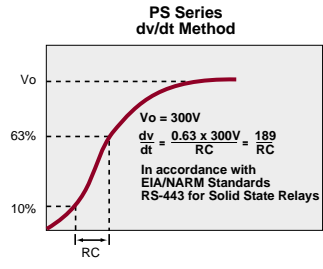
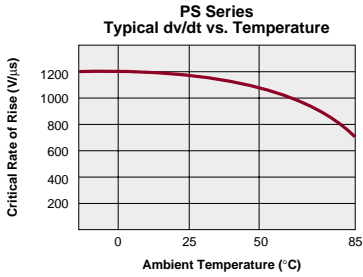
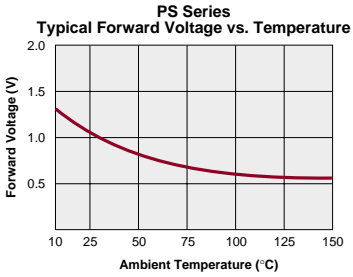
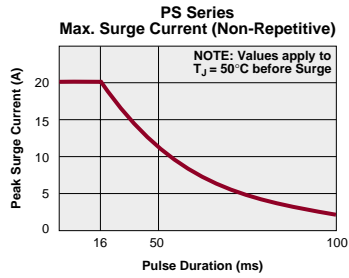
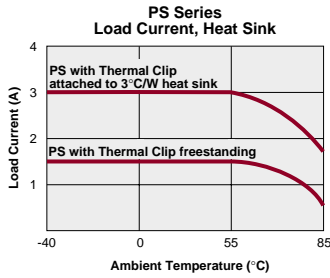
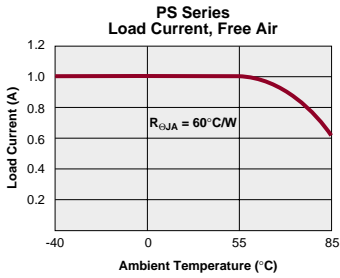

PM1204/PM1205/PM1206



DESCRIPTION

The PM1204/PM1205/PM1206 are AC Solid State Switches utilizing Dual Power SCR outputs. These devices also include zero turn on circuitry and are available with a blocking voltage up to 600V.

FEATURES

- Load Current up to 0.5A
- Blocking Voltage up to 600V
- 5mA Sensitivity
- Zero-Crossing Detection
- DC Control, AC Output
- Optically Isolated
- TTL and CMOS Compatible
- Low EMI and RFI Generation
- High Noise Immunity
- VDE compatible
- Machine Insertable, Wave Solderable

APPLICATIONS

- Programmable Control
- Process Control
- Power Control Panels
- Remote Switching
- Gas Pump Electronics
- Contractors
- Large Relays
- Solenoids
- Motors
- Heaters

APPROVALS

- UL recognized file #: E69938
- CSA certified file #: LR 43639-8

OPTIONS / SUFFIXES

- S: Surface Mount Package

PM Series Pinout

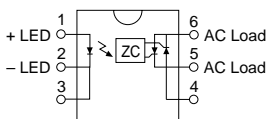

RATINGS (@ 25° C)

Parameter	Min	Typ	Max	Units
Input Power Dissipation	-	-	150 ¹	mW
Input Control Current	-	-	50	mA
Peak (10ms)	-	-	1	A
Reverse Input Voltage	-	-	5	V
Total Package Dissipation				
PM	-	-	800 ²	mW
Capacitance				
Input to Output	-	3	-	pF
Isolation Voltage				
Input to Output	3750	-	-	V _{RMS}
Operational Temperature	-40	-	+85	°C
Storage Temperature	-40	-	+125	°C
Soldering Temperature				
(10 Seconds Max.)				
DIP Package	-	-	+260	°C
Surface Mount Package	-	-	+220	°C

¹ Derate Linearly 1.33 mW/°C

² Derate Linearly 16.6 mW/°C

Note: For Mechanical Dimensions See Pages 396-401

AC POWER SWITCH

PM1204/PM1205/PM1206

SPECIFICATIONS

PARAMETERS	CONDITIONS	SYMBOL	PM1204			PM1205			PM1206			UNITS
			MIN	TYP	MAX	MIN	TYP	MAX	MIN	TYP	MAX	
Output Characteristics @ 25°C												
Peak Blocking Voltage	-	V_{DRM}	-	-	400	-	-	500	-	-	600	V
Load Current (Continuous)	$V_L=120-240V_{AC}$	I_L	0.005	-	0.5	0.005	-	0.5	0.005	-	0.5	A
Off State Leakage Current	V_{DRM}	I_{LEAK}	-	-	1	-	-	1	-	-	1	mA
On-State Voltage Drop	-	-	-	-	1.2	-	-	1.2	-	-	1.2	V_{RMS}
Critical Rate of Rise	-	dv/dt	1000	1200	-	1000	1200	-	1000	1200	-	V/ μ S
Switching Speeds												
Turn-on	$I_f=5$ mA	T_{ON}	-	-	0.5	-	-	0.5	-	-	0.5	cycles
Turn-off	$I_f=5$ mA	T_{OFF}	-	-	0.5	-	-	0.5	-	-	0.5	cycles
Zero-Cross Turn-On Voltage	1st half cycle	-	-	2	5	-	2	5	-	2	5	V
	Sub. half cycle	-	-	-	1	-	-	1	-	-	1	V
Operating Frequency ¹	-	-	20	-	500	20	-	500	20	-	500	Hz
Load Power Factor for Guaranteed Turn-On ²	-	PF	0.25	-	-	0.25	-	-	0.25	-	-	-
Input Characteristics @ 25°C												
Input Control Current												
For Normal Environment	-	I_F	5	-	50	5	-	50	5	-	50	mA
For High Noise Environment	-	I_F	10	-	100	10	-	100	10	-	100	mA
Input Voltage Drop	$I_F=5$ mA	V_F	0.9	1.2	1.4	0.9	1.2	1.4	0.9	1.2	1.4	V
Input Drop-out Voltage	-	-	0.8	-	-	0.8	-	-	0.8	-	-	V
Reverse Input Current	$V_R=5_V$	I_R	-	-	10	-	-	10	-	-	10	μ A
Common Characteristics @ 25°C												
Input to Output Capacitance	-	$C_{I/O}$	-	-	3	-	-	3	-	-	3	V_{RMS}
Input to Output Isolation	-	$V_{I/O}$	3750	-	-	3750	-	-	3750	-	-	V_{RMS}

¹ Zero Cross 1st half cycle @ <100Hz

² Snubber circuits may be required at low power factors.

Note: For Mechanical Dimensions See Pages 396-401

PERFORMANCE DATA

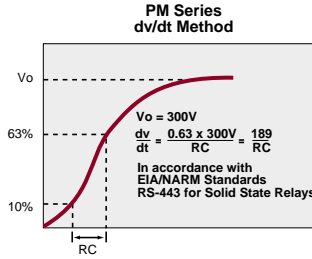
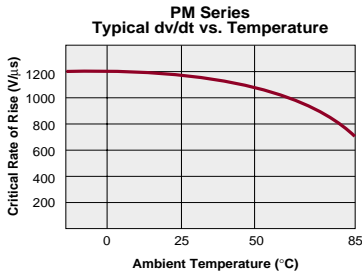
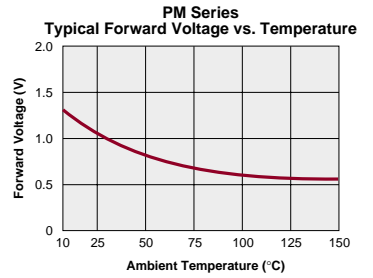
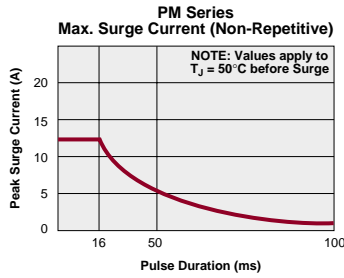
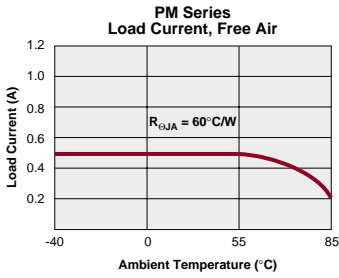



FEATURES

- Optically-Isolated Input to Output
- May be Configured for AC and DC Switching
- 5mA Control Current
- No EMI/RFI Generation
- Machine Insertable, Wave Solderable
- Surface Mount and Tape Reel Versions Available
- Dual Independent, Floating Outputs for Parallel, Series, or Isolated Configuration
- Replacement of Discrete Components
- Solid State Reliability
- VDE compatible

APPROVALS

- UL recognized file #: E76270
- CSA certified file #: LR 43639-12
- BSI Certified:
 - BS EN 60950:1992 (BS7002:1992)
Certificate #:7344
 - BS EN 41003:1993
Certificate #:7344

OPTIONS / SUFFIXES

- S: Surface Mount Package
- TR: Tape & Reel

DESCRIPTION

The FDA215 is an optically coupled photovoltaic driver with open circuit voltage equal to 5V(Typ) and short circuit current equal to 3.5μA(Typ).

APPLICATIONS

- MOSFET Driver
- Programmable Control
- Process Control
- Instrumentation
- Telecommunications

RATINGS (@ 25° C)

Parameter	Min	Typ	Max	Units
Input Power Dissipation	-	-	150 ¹	mW
Input Control Current	-	-	100	mA
Peak (10ms)	-	-	1	A
Reverse Input Voltage	-	-	5	V
Power Dissipation				
Total Package Dissipation	-	-	500 ²	mW
Capacitance				
Input to Output	-	3	-	pF
Isolation Voltage				
Input to Output	3750	-	-	V _{RMS}
Operational Temperature	-40	-	+85	°C
Storage Temperature	-40	-	+125	°C
Soldering Temperature				
(10 Seconds Max.)				
DIP Package	-	-	+260	°C
Surface Mount Package	-	-	+220	°C

¹ Derate Linearly 1.33 mw/°C

² Derate Linearly 1.67 mw/°C

Note: For Mechanical Dimensions See Pages 396-401

SPECIFICATIONS

PARAMETERS	CONDITIONS	SYMBOL	MIN	TYP	MAX	UNITS
Output Characteristics @ 25°C						
Load Voltage	-	V_L	-	-	10	V
Load Current	-	I_L	-	-	1	μ A
Open Circuit Voltage	$I_F=5\text{mA}$	V_{OC}	-	5.5	8	V
Short Circuit Current	$I_F=5\text{mA}$	I_{SC}	1.0	2.5	-	μ A
Short Circuit Current	$I_F=25\text{mA}$	I_{SC}	2.5	3.5	-	μ A
Switching Speeds						
Turn-on	$I_F=5\text{ mA}, C_{LOAD}=200\text{pF}$	T_{ON}	-	-	5.0	mS
Turn-off	$I_F=5\text{ mA}, C_{LOAD}=200\text{pF}$	T_{OFF}	-	-	5.0	mS
Offstate Clamping Resistance	-	R_{CL}	-	0.25	3.3	$K\Omega$
Input Characteristics @ 25°C						
Control Current	-	I_F	5	-	100	mA
Input Voltage Drop	$I_F=5\text{mA}$	V_F	0.9	1.2	1.4	V
Reverse Input Voltage	-	V_R	-	-	5	V
Reverse Input Current	-	I_R	-	-	10	μ A
Common Characteristics @ 25°C						
Input to Output Capacitance	-	$C_{I/O}$	-	3	-	pF
Input to Output Isolation	-	$V_{I/O}$	3750	-	-	V_{RMS}

FDA215 Pinout

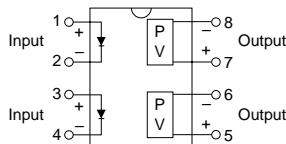

Note: For Mechanical Dimensions See Pages 396-401

www.cpcclare.com

6 Pin DIP Through Hole (Standard)

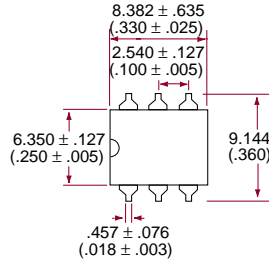
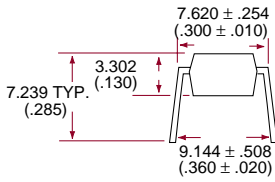

PC Board Pattern (Top View)

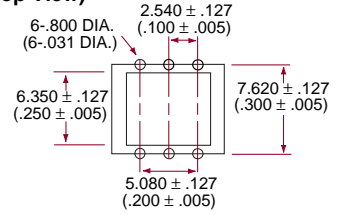

6 Pin DIP Surface Mount ("S" Suffix)

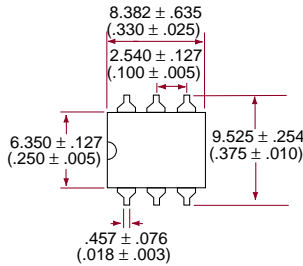
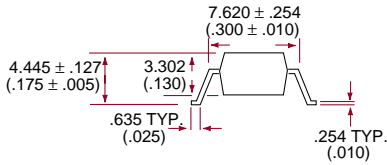

PC Board Pattern (Top View)

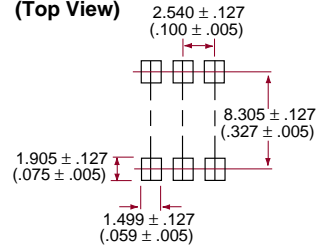

8 Pin DIP Through Hole (Standard)

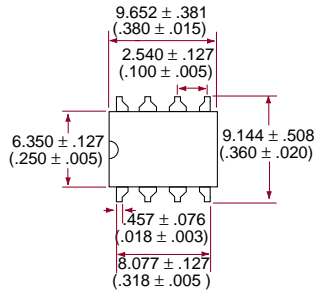
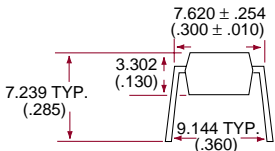

PC Board Pattern (Top View)

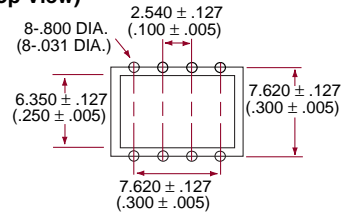

8 Pin DIP Surface Mount ("S" Suffix)

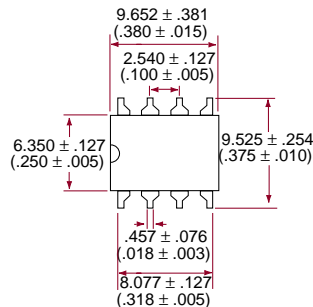
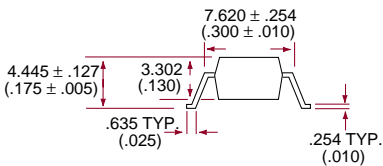

PC Board Pattern (Top View)

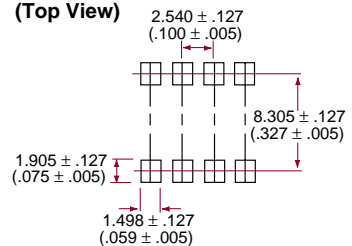

DIMENSIONS
mm
(inches)

Note: Coplanarity = .004 max. for surface mounted devices

8 Pin SOIC Narrow ("N" Suffix)

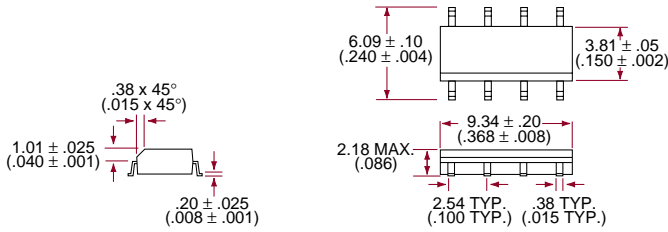

PC Board Pattern (Top View)

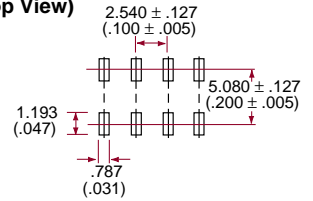

8 Pin Flatpack ("P" Suffix)

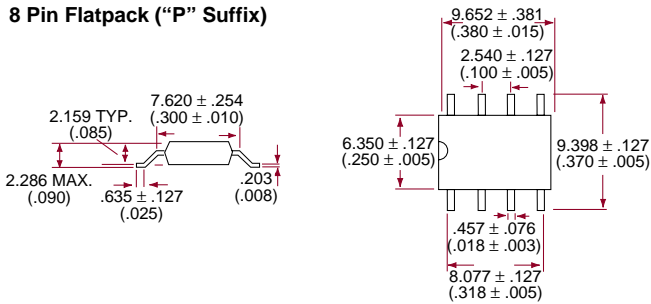

PC Board Pattern (Top View)

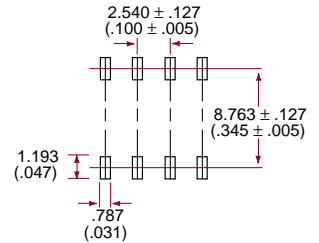

16 Pin SOIC ("P" Suffix)

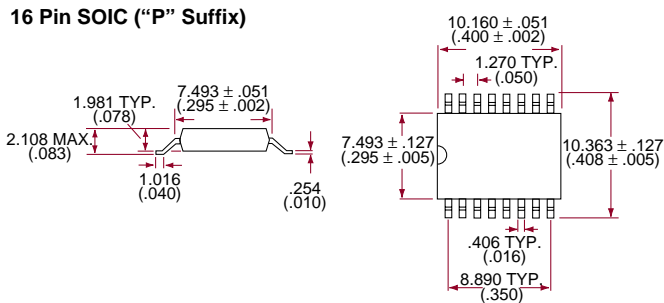

PC Board Pattern (Top View)

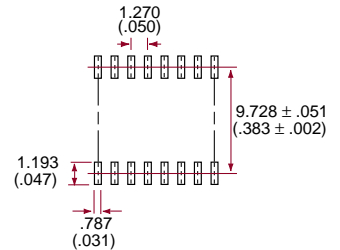

16 Pin DIP Through Hole (Standard)

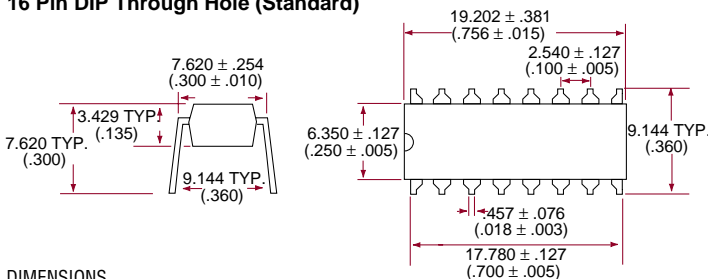

PC Board Pattern (Top View)

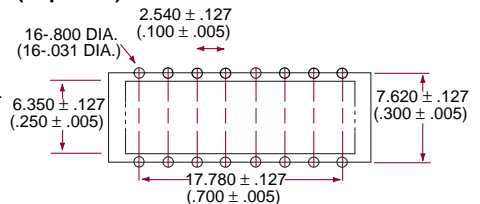

DIMENSIONS:
 mm
 (inches)

Note: Coplanarity = .004 max. for surface mounted devices

MECHANICAL DIMENSIONS

16 Pin SOIC Narrow ("N" Suffix)

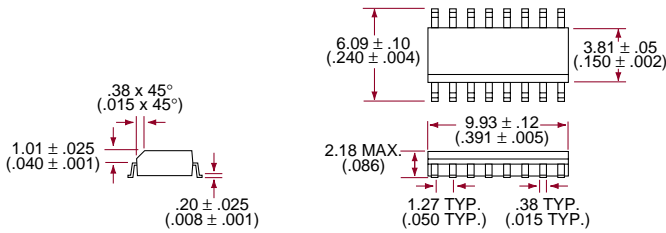

PC Board Pattern (Top View)

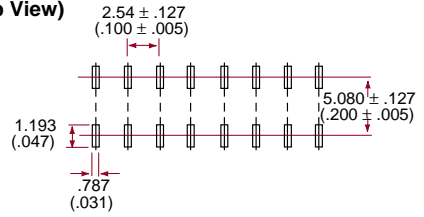

8 Pin SIP

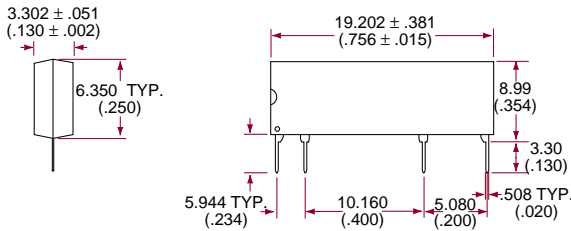

16 Pin DIP

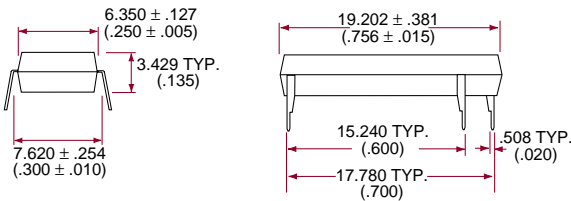

Thermal Clip

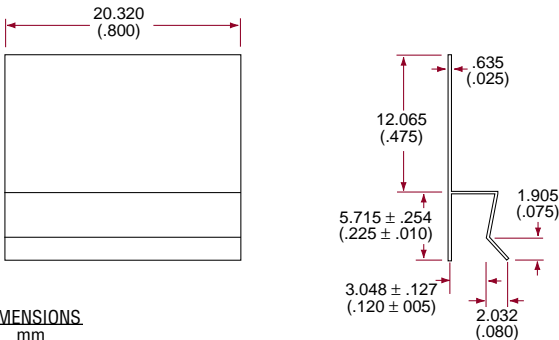

DIMENSIONS
mm
(inches)

Note: Coplanarity = .004 max. for surface mounted devices

Tape and Reel Packaging for 6 Pin Surface Mount Package

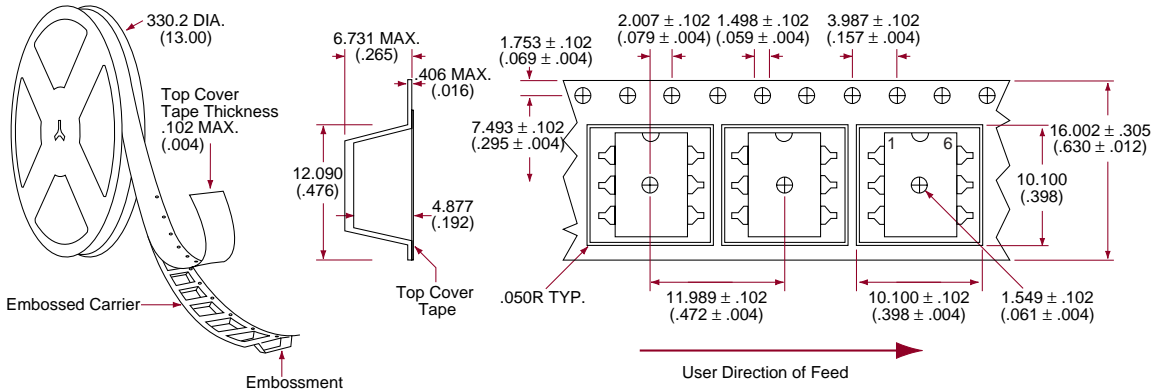

Tape and Reel Packaging for 8 Pin Surface Mount Package

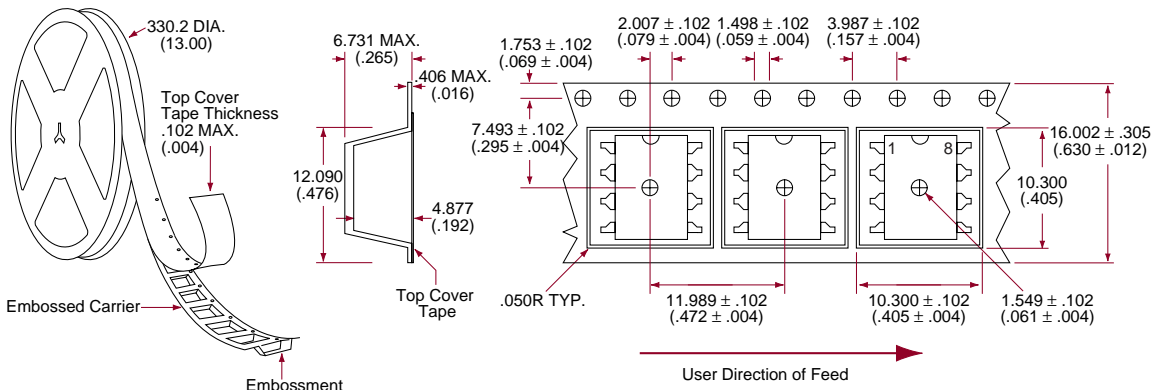

Tape and Reel Packaging for 8 Pin Flatpack Package

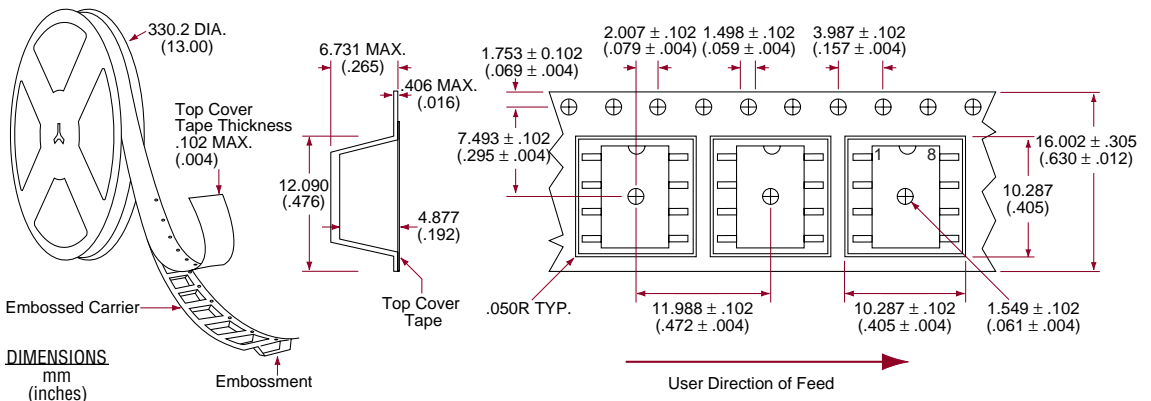

DIMENSIONS
mm
(inches)

Tape and Reel Packaging for 16 Pin SOIC Package

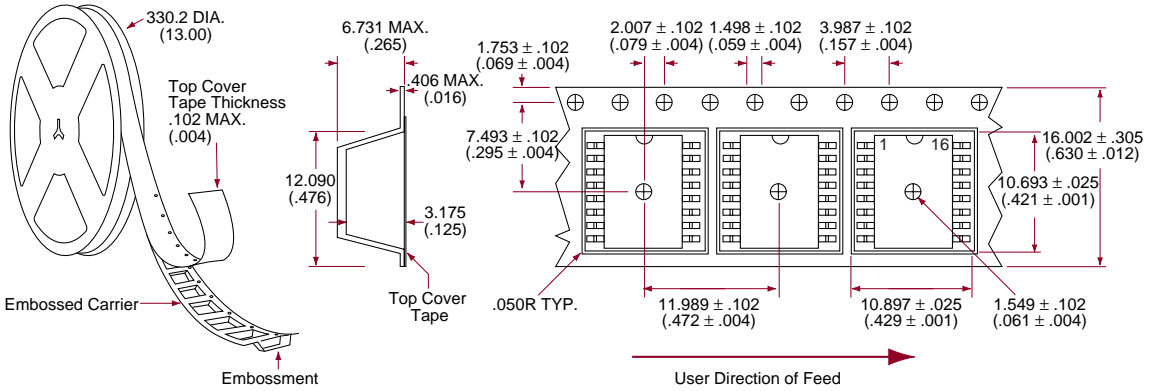

Tape and Reel Packaging for 8 and 16 Pin Narrow SOIC Package

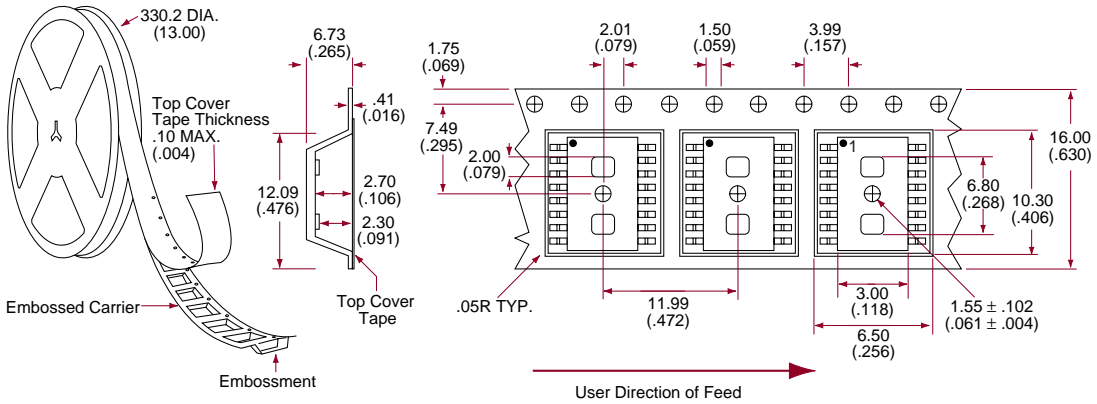

DIMENSIONS
mm
(inches)

CYG20XX/CYG2911

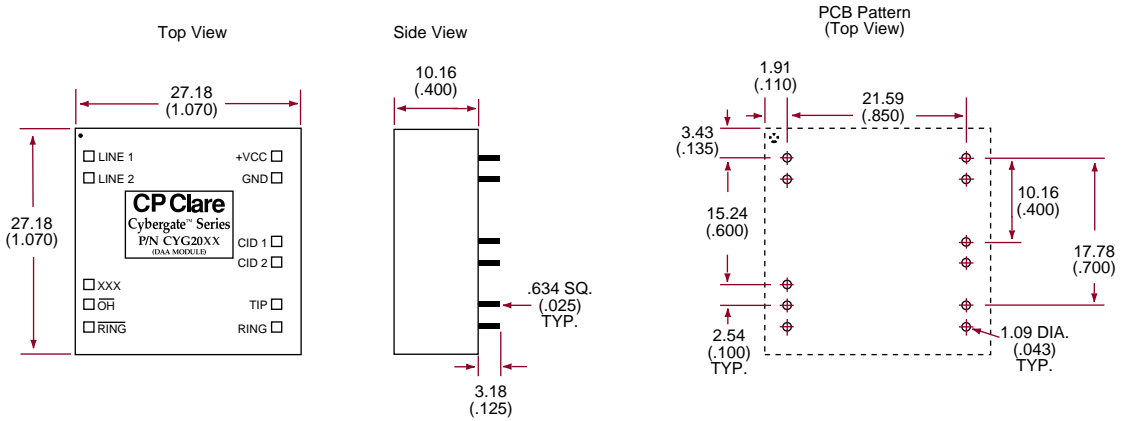

CYG21XX

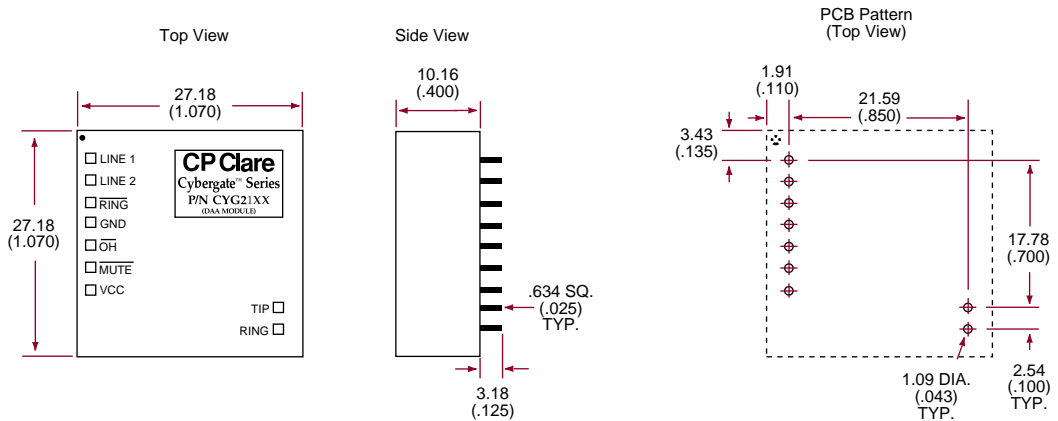

CYG22XX

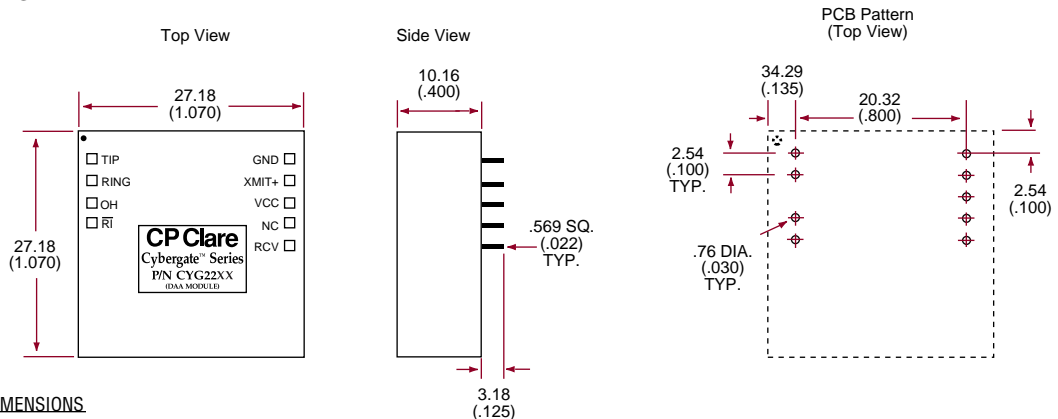

DIMENSIONS
 mm
 (inches)

FCC Part 68

All equipment connecting to the U.S. telephone network must meet the technical and marketing regulations set forth in the FCC's Part 68 rules. CP Clare's OptoMOS devices, which are widely used in telecommunication circuits, are specifically designed to be compatible with these requirements. Regarding the specifics of Part 68, there are two main areas of concern: The Metallic Surge Test and The Longitudinal Surge Test (The Metallic Surge Test is defined as the differential surge voltage across the tip and ring conductors, while the Longitudinal Surge Test is defined as the differential surge voltage across tip and ring shorted together and ground). The purpose of each test is to subject the EUT (equipment under test) to simulated lightning and other transients which may occur on telephone and power lines. The critical details of these test are outlined below.

Metallic Voltage Surge

A major concern, when designing to FCC Part 68, is whether or not the individual components of your telecommunication circuit will pass the Metallic Surge Test. The waveform specification for this transient is an 800V peak surge, with a maximum rise-time-to-crest of 10ms and a 560ms minimum decay-time-to-half-crest applied between tip and ring circuits (example outlined in figure 1) of the EUT. In all, two surges are applied - one in each polarity. Although the EUT may suffer damage during this test, it must meet the "non-harm" clause included in FCC Part 68. To elaborate, while it would be acceptable if a unit remained in the permanently on-hook state (line open), it is not acceptable for it to fail in the permanently off-hook state (line seized).

Longitudinal Voltage Surge

Another major concern with FCC Part 68 is the Longitudinal Voltage Surge Test. The specifications for this particular transient is a 1500V peak surge applied in each polarity from the tip connection of the telecommunication circuit (individually) to ground, the ring connection to ground and from the tip and ring connection shorted together to ground. The surge has a maximum rise-time-to-crest of 10ms and a minimum decay-time-to-half-crest of 160ms. This test is actually comparable to an I/O dielectric withstand test. Since CP Clare parts meet 2500 (3750 optional) I/O isolation, the test will not pose a problem.

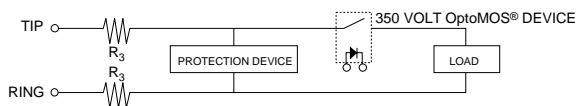

Figure 1

Current Limiting

Current limited solid state relays (SSR) are fast becoming the wave of the future as a means for protection against power cross, transients and lightning strikes. Currently, CP Clare offers the current limiting option for nearly all of our 1-Form-A SSRs (“L” suffix is added to part number). The main advantage to using this type of relay is the “two-fold” protection it provides. Because the integrated current limiting circuitry instantaneously limits current through the relay, it is in effect self protecting. In addition to protecting itself, it will also protect any circuitry beyond the relay from receiving high current spikes.

As designed, current applied to the input LED results in the emission of light, which is immediately sensed by the photovoltaic (PV) cell in the output circuitry of the relay. Once this occurs, the PV essentially becomes a voltage source. The voltage produced is instantaneously applied to the gates of the output MOSFETs, driving

them into the “on” or “closed” state. If a fault occurs at the output while the relay is in this state, the current limiting feature activates immediately. If the fault is continuous, the proprietary circuitry will continue to limit the current and the relay will begin to “shut down”, causing a continuous decrease in the load current passed through the output of the relay.

The key to the current limiting circuitry is that it has a negative temperature coefficient, which keeps the limit of power dissipation to safe levels during high-on voltage conditions. Once these conditions have subsided, the SSR resumes normal operation. It is important to realize that operation during the current limiting state is generally recommended for short duration high energy transients, not prolonged overvoltage conditions. This is mainly due to that during the limiting state, the device actually exceeds that maximum total power dissipation rating for its package. Continuous operation under these conditions may eventually damage the SSR internally.

Linear Optocouplers

Introduction

This application note describes isolation amplifier design principles for the LOC Series linear optocoupler devices. It describes the circuit operation in photoconductive and photovoltaic modes and provides some examples of applications in different industry segments. The LOC product is intended to give the designer an alternative to bulky transformers and “non-linear” optocouplers for many applications.

Galvanic isolation is required for many circuits found in Telecommunication, Industrial, Medical and Instrumentation systems. This has been traditionally accomplished by means of transformers and optocouplers with transformers being used to couple AC signals and optocouplers used primarily for DC signal coupling. Unlike standard optocouplers, the LOC operates in a servo mode configuration which compensates for the LED’s non-linear time and temperature characteristics. In addition, the LOC can couple both AC and DC signals.

The following are examples where galvanic isolation is required:

- Telecommunications: Telecom products such as modems require isolation and signal coupling from the telephone line to the modem data pump.
- Industrial Control: Products such as temperature sensors and controllers. Temperature sensors are often remotely located from the controller and reside in hazardous environments near high voltage lines. Isolation provides the required signal coupling while insuring safety to personnel working with the controller.
- Medical: EEG and ECG machines have sensors that attach to the patient. The sensors are galvanically isolated to provide a high voltage isolation barrier between patient and machine.
- Instrumentation: Often use isolated switching supplies where it is required to sense the output voltage and feedback a portion of the signal to the controller for voltage regulation while not compromising power supply isolation.

Description

The LOC Series (LOC110, LOC111 and LOC112 with one optocoupler per package, and LOC210 and LOC211P with two per package) are linear optocouplers designed to be used in applications where galvanic isolation is required for AC and DC signal coupling and linearity from input to output must be accurately preserved. The device consists of an infra-red LED optically coupled with two phototransistors. One phototransistor is typically used in a servo feedback mechanism to control the LED drive current which has the effect of compensating for the LED’s non-linear time and temperature characteristics. The other output phototransistor is used to provide the galvanic isolation between the input and output circuit. A typical isolating amplifier is shown in figure 1.

Circuit Operation Utilizing the LOC110

Photoconductive Operation

With V_{IN} at 0V and I_F at 0mA, U1 has large open loop gain. As V_{IN} begins to increase, the output of U1 begins to go to the V_{CC1} rail. As it does, I_F current begins to flow and the LED begins to turn on. As the LED turns on, the incident optical flux on the servo phototransistor causes a current I_1 to flow. As I_1 flows through R1, a voltage is developed on the inverting input of the op amp V_A such that the output of the amplifier will begin to go to the negative supply rail (ground in this case). When the voltage on V_A is equal to V_{IN} , I_F will no longer increase and the circuit is now in a stable closed loop condition. If V_{IN} is modulated, V_A will track V_{IN} . The flux generated by the LED is also incident on the output phototransistor and generates a current I_2 which is proportional to the LED flux and LED current; this current closely tracks I_1 . The output voltage of the amplifier is the product of the output photocurrent I_2 and resistor R2. The equations and definitions of the circuit are listed below (including figure 1).

Servo Gain - K1

Defined as the ratio of the servo photocurrent I_1 to the LED forward current I_F : $K1 = I_1/I_F$.

For the LOC110, K1 is typically 0.007 for an I_F of 10mA and a V_{CC} of 15V.

Forward Gain - K2

Defined as the ratio of the output photocurrent to the LED forward current I_F : $K2 = I_2/I_F$.

K2 is typically 0.007 for an I_F of 10mA and V_{CC} of 15V.

Transfer Gain - K3

Defined as the ratio of K2 to K1: $K3 = K2/K1$.

Design Example: (Refer to figure 1)

For an input span of 0 to 2V, an output of 0 to 4V is desired. Values for R1 and R2 need to be determined. Both amplifiers will have an independent V_{CC} of +5V.

Determining R1:

Since the product of the servo photocurrent I_1 and R1 will track V_{IN} :

$$1. \quad V_{IN} = I_1 \cdot R1$$

Now I_1 is the photocurrent generated by the LED flux. The LED flux is generated by the LED current I_F . I_1 is proportional to I_F and the LED flux by the proportionality constant K1, which has been defined as the servo gain:

$$2. \quad I_1 = K1 \cdot I_F$$

To best determine R1, the maximum desired value of I_F should be used in the above equation that would correspond to a maximum V_{IN} of 2V. For this example an op amp output of 15mA is selected. Substituting equation #2 for I_1 in equation #1 and solving for R1 yields:

$$3. \quad R1 = \frac{V_{IN}}{(K1 \cdot I_F)}$$

Using the minimum value of 0.004 for K1 and substituting 2V for V_{IN} and 15mA for I_F (max.) gives a value of 33.3K Ω .

Determining R2:

The output voltage V_{OUT} is related to R2:

$$4. \quad V_{OUT} = I_2 \cdot R2$$

Photocurrent I_2 is proportional to the LED flux and LED current I_F by the proportionality constant K2:

$$5. \quad I_2 = I_F \cdot K2$$

Substituting equation #5 for I_2 in #4 and solving for R2:

$$6. \quad R2 = \frac{V_{OUT}}{(I_F \cdot K2)}$$

where $I_F=15\text{mA}$, $K2 = 0.004$, $V_{OUT} = 4\text{V}$

Substituting the above values gives an R2 of 66.6K Ω .

The amplifier will produce a 4V output when a 2V input is applied. A plot of V_{IN} vs. V_{OUT} is shown in figure 2. Photoconductive amplitude and phase response is shown in figures 2A and 2B, respectively.

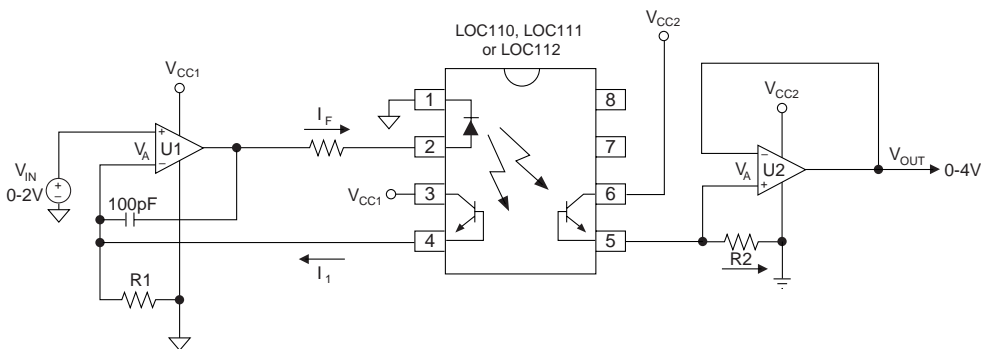

Figure 1. Isolation Amplifier (Photoconductive Operation)

Linear Optocouplers

The following derivation ties the example and definitions to one equation relating all the parameters for this circuit: Solving equation #3 for V_{IN} :

$$7. \quad V_{IN} = I_F \cdot K1 \cdot R1$$

Combining equation #4 and #5 and solving for V_{OUT} :

$$8. \quad V_{OUT} = I_F \cdot K2 \cdot R2$$

Dividing equation #7 by equation #8 and solving for V_{OUT} gives the final equation:

$$9. \quad V_{OUT} = \frac{V_{IN}(K2 \cdot R2)}{(K1 \cdot R1)}$$

and since the definition of $K3$ is $K3 = K2/K1$ we can further simplify by writing:

$$10. \quad V_{OUT} = V_{IN} \cdot K3 \cdot \frac{R2}{R1}$$

I_F was canceled out of equation #10. This is due to the fact that both servo and output photocurrents originate from the same LED source. Since $K3$ is the ratio $K2/K1$, in our example $K1 = K2 = 0.004$, and $K3 = 1$.

Therefore, V_{OUT} is directly proportional to the ratio of $R2/R1$.

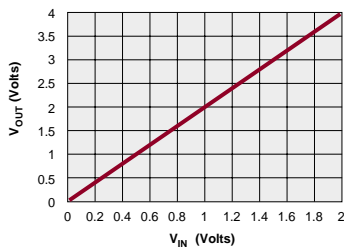

Figure 2. V_{IN} vs. V_{OUT}

The circuit in figure 1 is configured with the phototransistor collector to base reverse biased. This is operation in the photoconductive mode. When an application requires amplifier bandwidth of up to 200kHz, the photoconductive configuration should be used. This mode has linearity and drift characteristics comparable to a 8-bit D/A converter with ± 1 bit linearity error.

Photovoltaic Mode

Using the LOC product in the photovoltaic mode achieves the best linearity, lowest noise and drift performance. It is possible to achieve up to 14-bit D/A linearity in this mode. The tradeoff with this topology is that bandwidth is limited to about 40kHz. A typical isolation amplifier in the photovoltaic configuration is shown in figure 3.

In the photovoltaic mode, the LOC phototransistors act as current generators. Since all photogenerators display some voltage dependence on linearity, maintaining a 0V bias on the phototransistor eliminates this problem and improves linearity. If the phototransistor is connected across a small resistance, the output current

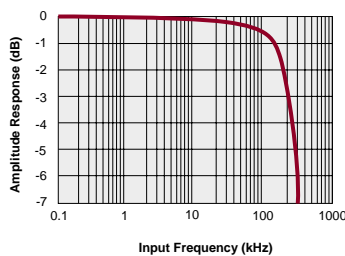

Figure 2A. Photoconductive Amplitude Response

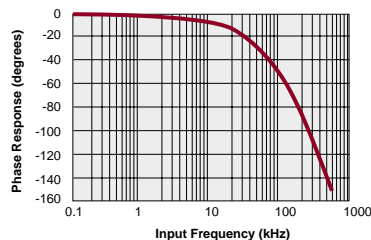

Figure 2B. Photoconductive Phase Response

is linear with increases in incident LED flux. To accomplish this, the phototransistors are connected across the op amp inputs. As V_{IN} increases, the current through the LED increases and so does the optical flux. The LED flux is incident on the servo phototransistor which starts current I_1 to flow from the op amp inverting input through the phototransistor. This servo photocurrent is linearly proportional to V_{IN} , $I_1 = V_{IN}/R1$ and keeps the voltage on the inverting input equal to zero.

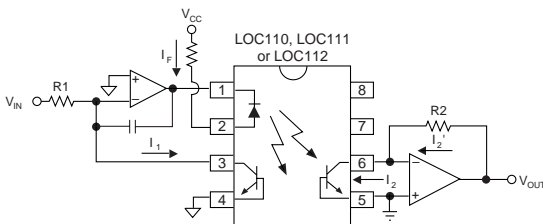

Figure 3. Isolation amplifier (Photovoltaic Operation)

The flux from the LED is also incident on the output phototransistor which causes a current I_2 to flow from the inverting input of the output op amp through the phototransistor. As I_2 is pulled from the inverting node, the output of the amplifier begins to go high until a current equal in magnitude to I_2 is injected into the inverting node of the amplifier. Since this current, I_2' , flows through $R2$, an output voltage is developed such that $V_{OUT} = I_2' \cdot R2$. Since $I_2 = I_2'$, $V_{OUT} = I_2 \cdot R2$. The composite equation describing the operation of this circuit is the same as in the photoconductive mode, that is: $V_{OUT} = V_{IN} \cdot K3 \cdot R2/R1$.

The frequency and phase response for this circuit is shown in figures 4 and 5 respectively. This circuit has a bandwidth of approximately 40kHz.

Using the LOC210P or LOC211P in a Modem Data Access Arrangement (DAA) Circuit.

Background

In the past, the only way to couple signals from the telephone line and provide the isolation necessary has been to use a transformer. With the advent of pocket and PCMCIA (Personal Computer Memory Card International Association) modems, however, the transformer has become a liability in terms of the size, weight and PCB real estate it occupies. Today, PCMCIA modems demand rugged on-board DAA circuits. The LOC eliminates the transformer problem with no performance sacrifice and improved manufacturability and reliability. With Total Harmonic Distortion typically at -87dB and servo non-linearity less than 0.01%, the LOC210P is well suited for high speed modem applications.

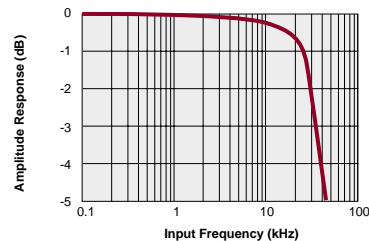

Figure 4. Photovoltaic Amplitude Response

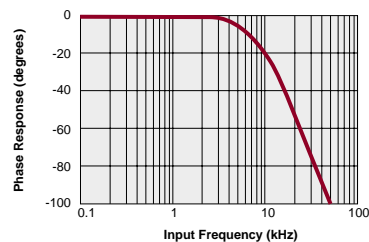

Figure 5. Photovoltaic Phase Response

Linear Optocouplers

Description

One LOC210P or LOC211P is required for full duplex operation. One half of the LOC is used in the transmit path and the other in the receive path. The photovoltaic mode of operation is usually selected for high speed modem circuits due to the improved linearity and lower noise. Figure 6 shows a schematic of this DAA. The LOC210P or LOC211P is connected in a similar manner to the circuit shown in Figure 3. While there are many ways to design a DAA with the LOC, the figure is intended to be used by the designer as a possible starting point.

Transmit Path

Referring to Figure 6, the TX input of the DAA is AC coupled to the modem's data pump transmit signal via C1. Resistor R5 pre-biases the input amplifier such that a quiescent forward current in the LED is established. The transmit signal from the modem will modulate the LOC LED current above and below this quiescent current. Transistor Q2 provides drive current for the LED. This is required to prevent hard output loading of the op amp which would increase Total Harmonic Distortion (THD) and increase non-linearity. The output of the amplifier is AC coupled via C8 to the base of Q1. Q1 modulates the loop current on the telephone line in response to the transmit signal thus transmitting the modem's signal over the telephone line.

Receive Path

The receive signal across tip and ring is coupled through R1 and C3 to the input of the isolation amplifier. The receive amplifier drives the LOC LED which takes its power from across the telephone line. The LOC couples this signal which is then AC coupled via C4 and then goes to the receive input of the modem's data pump.

Echo Cancellation

The transmit signal is removed from the receive path by taking advantage of the inherent signal phase shifts around Q1. The transmit signal on the emitter is 180 degrees out of phase with the transmit signal on the collector. R1 and R2 can be selected such that the transmit signal is essentially canceled out on the node of R1 and R2 while not effecting the receive signal. This cancellation or "trans-hybrid loss" can exceed 30 dB with 1% resistor values and careful matching. It's important to have the modem DAA impedance match the central office impedance which will have the effect of reducing echo. R4 and C5 form an impedance network of 600Ω. Another benefit from R4 and C5 is that it provides V_{CC2} with AC rejection which is used to power the isolating amplifiers on the line side of the circuit.

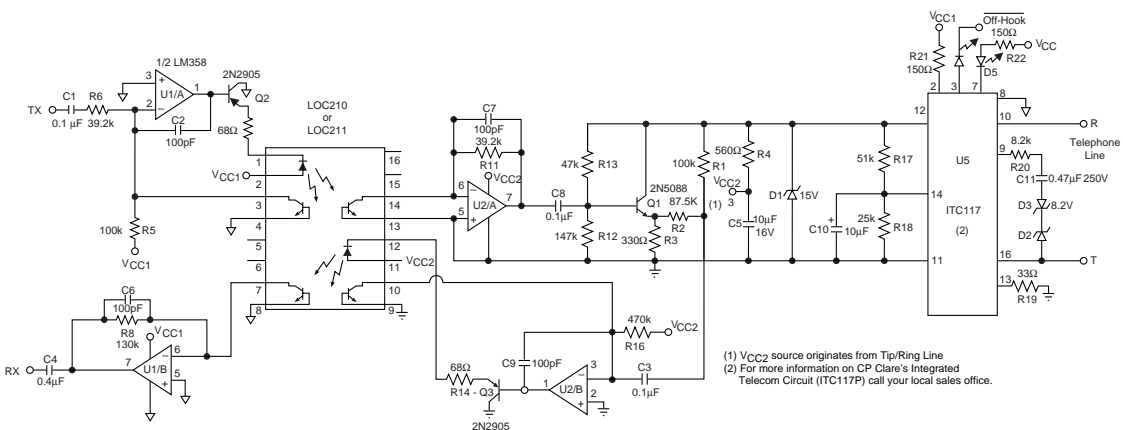

Figure 6. Typical Modem DAA using the LOC210P

Electronic Inductor

The purpose of the electronic inductor circuit is to sink loop current when the modem goes off-hook thus seizing the phone line. The circuit usually consists of a Darlington transistor, a resistor bias network, and a capacitor to provide AC rejection. This circuit should be designed to work throughout the range of loop currents per FCC Part 68.3. The circuit also presents a high AC impedance to the line so that signal integrity is not compromised. The zener diode is installed for protection of the Darlington transistor and other circuitry on the line side. The zener voltage is selected based on the voltage rating of the other components selected. Refer to Appendix 1 for details on the electronic inductor design.

Switch Mode Power Supply Application (LOC110, LOC111 or LOC112)

Another useful application for the LOC110, LOC111 or LOC112 is in the feedback control loop of isolated switching power supplies. Typically, the DC output voltage of the supply is monitored and fed back to the control input of the switcher through isolated means in order to regulate the output voltage. The most common way of doing this in the past has been to use an additional winding on the isolation transformer, figure 7A.

This winding would generate an AC signal which then needed to be rectified, filtered, and possibly scaled down with a resistor network before going into the control input of the switcher. Using the LOC110, LOC111 or LOC112 to accomplish the same task is a better solution since the special transformer windings, rectification, and filtering are eliminated. Also, the problem of poor load regulation due to inadequate winding coupling is eliminated. Referring to figures 7B and 7C, the design is almost identical to the basic photoconductive isolated unity gain amplifier discussed previously, however a voltage divider consisting of R_A and R_B is added.

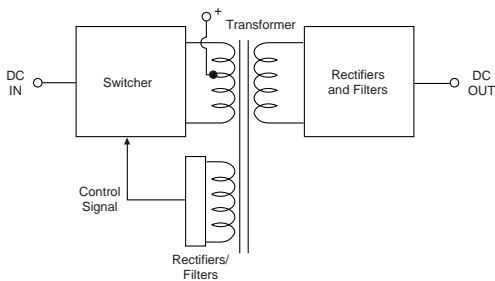

Figure 7A. DC-to-DC Converter with Feedback Winding

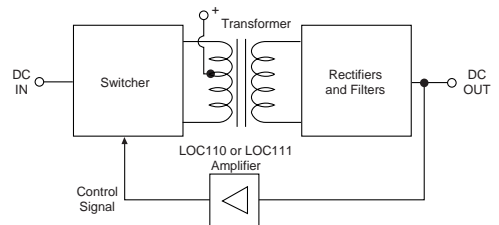

Figure 7B. DC-to-DC Converter with LOC110, LOC111 or LOC112 (Block Diagram)

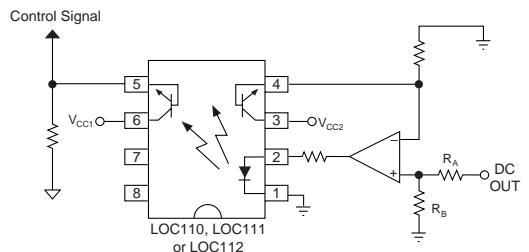

Figure 7C. DC-to-DC Converter with LOC110, LOC111, or LOC112 (Schematic)

Linear Optocouplers

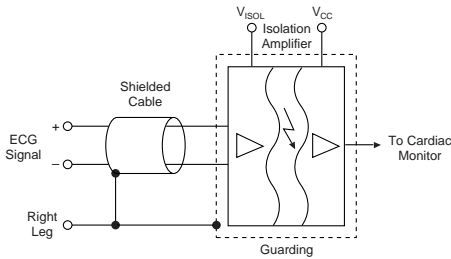

Figure 8. LOC110 Isolated Amplifier in ECG Application

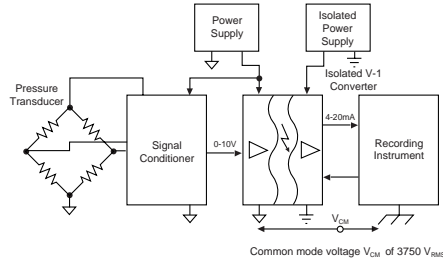

Figure 9. Isolated Pressure Transmitter

Cardiac Monitoring Application

Designing equipment to measure Cardiac signals such as the Electrocardiogram (ECG) presents some special problems. Cardiac signals for adults are approximately 1mV in magnitude while for a fetus can be as low as 50 μ V. Since the heart signals are low in amplitude, noise such as residual electrode voltages and 50/60Hz power line pickup can easily swamp out the signal. Therefore, it is important to design an isolated amplifier circuit which interfaces to the probe that has high Common Mode Rejection (CMR) ratings to reduce or eliminate common mode noise while providing amplification for the heart signals.

The LOC110, LOC111 or LOC112, with the proper support circuitry, can provide the isolation, amplification, linearity, and high CMRR that is required for this type of

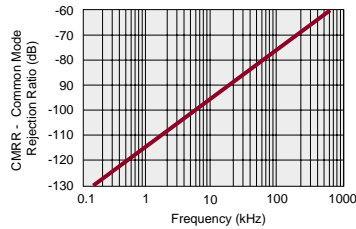

Figure 9A. Common Mode Rejection

application. Referring to the diagram in figure 8, the isolated amplifier block contains the LOC110, LOC111 or LOC112 and high CMRR op amps. The electrodes are connected to the amplifier via shielded cable to provide noise immunity. The shield is connected to the patient's right leg for best CMR performance. For good performance, proper shielding, PCB layout and amplifier, design techniques should be practiced.

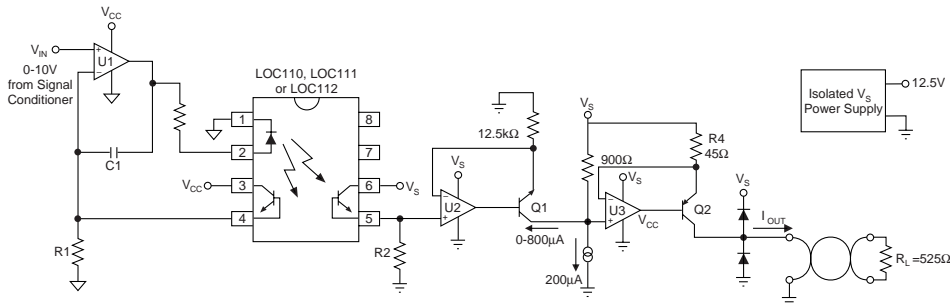

Figure 9B. 0-10V to 4-20mA Converted

Isolated 0-10V to 4-20mA Converter Application

Industrial controllers and data acquisition equipment frequently require an isolated voltage-to-current loop converter in environments where high common mode noise exists and protection of equipment and personnel from high voltages are required. The current loop, usually 4-20mA, is used to drive control valves or the input to chart recorders for temperature/pressure monitoring over time for example. Figure 9 shows a simplified block diagram of an isolated pressure transmitter.

The LOC110, LOC111 or LOC112, with a typical Common Mode Rejection Ratio of 130dB (see figure 9A) and isolation voltage up to 3750V_{RMS} (E version) is a good choice for this kind of application. The example circuit for this application is shown in figure 9B. The LOC110, LOC111 or LOC112 is in the photoconductive mode which has linearity comparable to an 8 bit D/A converter with ± 1 LSB nonlinearity or 0.39% of full scale.

For this example, the input to the circuit is 0-10V from the output of the pressure transducer signal conditioner, R1 and R2 are calculated based on the K3 of the LOCs being used and should be selected to achieve unity gain for the amplifier. Note that the isolation amplifier portion of the circuit is very similar to the basic photoconductive amplifier discussed earlier. The difference is the addition of pass transistor Q1 in the negative feedback loop of U2. V_{CC} is the non-isolated power supply and V_S is the isolated power supply which is 12.5V for this example. This supply does not require strict regulation as U3 maintains current regulation for the loop.

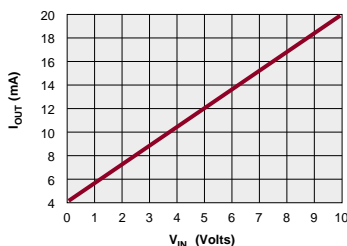

Figure 10. V_{IN} vs. I_{OUT}

When a 0V input is applied to U1 from the signal conditioner, Q1 will be off and not sink any current. The constant current source connected to the non-inverting input of U3 sinks a continuous current of 200 μ A. A device such as the LM341A zener shunt regulator can be configured as a constant current source for this purpose. This current is converted to a 4mA current by U3, Q2, and R4 which drives the load R_L . When V_{IN} is 10V, transistor Q1 sinks 800 μ A of current. This 800 μ A, plus the constant current of 200 μ A, result in an I_{OUT} of 20mA delivered through the load R_L . The two 1N4001 diodes are installed for protection when driving inductive loads. V_{IN} vs. I_{OUT} is shown in figure 10.

Summary

Here are some guidelines when designing with the LOC:

1. Use photoconductive mode for applications where up to 200kHz bandwidth is required and linearity comparable to an 8-bit D/A converter with ± 1 LSB (Least Significant Bit) linearity error is acceptable.
2. Use photovoltaic mode where up to 40KHz bandwidth is required and linearity comparable to a 13-to-14 bit D/A converter with ± 1 LSB linearity error (0.01%) is acceptable.
3. Drive LED with a transistor buffer to maintain the best linearity and to keep Total Harmonic Distortion (THD) to a minimum.
4. For high resistance values (>30K), it may be necessary to put a 100pF capacitor from the output of the op-amp to the input as shown in figure 1. This will help prevent oscillations.
5. For bipolar operation, select a quiescent LED current. The superimposed AC input signal will swing above and below this current. A quiescent LED current is generated by pre-biasing the op amps such that in the absence of an AC signal, a current flows through the LED.

The following is a brief list of possible op amps[†] which may be used in conjunction with the LOC Series:

- LMC6484
- LM358
- LM201
- LM1558

[†]Please note this is not a complete listing of op amps.

Linear Optocouplers

Industry Segment	Application	Mode	Function
	Modem DAA	PV Mode for best linearity 0.01% with — 40KHz bandwidth	H.V. Isolation, Signal Coupling
	PBX Isolated SWPS* for Ring Generator	PC Mode for 200KHz bandwidth 0.39% linearity	Isolated voltage sensing for SWPS* feedback
Industrial	Industrial RTD (Resistance Temp. Device)	PV or PC depending on desired linearity and bandwidth	High CMRR** for noise immunity, HV isolation, signal coupling
	Isolated Pressure Sensing	PV or PC depending on desired linearity and bandwidth	High CMRR** for noise immunity, HV isolation, signal coupling
	Isolated 4-20mA Converters	PV or PC depending on desired linearity and bandwidth	High CMRR** for noise immunity, HV isolation, signal coupling
Medical	Isolated EGG/ECG Amplifier	PV or PC depending on desired linearity and bandwidth	Couples low level signals from transducers, HV isolation, noise immunity
Instrumentation	PH Probe	PV Mode	Maintains high CMRR** for remote PH probe, provides amplification and HV isolation

*SWPS: Switch Mode Power Supply **CMRR:Common Mode Rejection Ratio

Table 1. Typical Applications Using the LOC110/LOC210P

Appendix 1

Electronic Inductor Design

The electronic inductor approximates the operation of a discrete inductor by using a Darlington transistor, three (3) resistors and a capacitor. When used in a modem application, the electronic inductor will present a relatively low impedance to DC currents and a relatively high impedance to AC signals.

Circuit Description

Figure 1 shows the electronic inductor in a typical modem environment. Bridge D2 rectifies current on tip and ring for the electronic inductor only. This ensures line-polarity insensitivity required by most regulatory agencies. Diode D1 protects Darlington Q1 from excessive transient voltages when going off-hook. The zener voltage should be less than the V_{CE0} of the Darlington. R1 and R2 set the biasing point for Q1. C1 is used for AC rejection of signals at the base of Q1. C1 should be a good quality Tantalum rated at a minimum of 10WV. R3 is used to provide negative feedback for Q1 so that Q1 will not go into saturation over the loop current range. The AC signal path is coupled to the modem's transformer via C2. C2 should have a working voltage of 100V, or 50V if two capacitors are used, one on each lead of the primary (see figure 1).

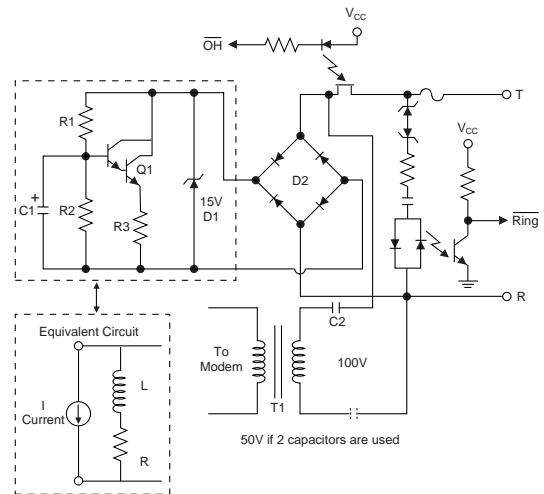

Figure 1. Dry Circuit with Electronic Inductor

2. Maximum loop current:
 - CO battery is 56.5V DC
 - Loop DC resistance is 400Ω
 - Electronic coil has the lowest DCR of 90Ω
the resulting maximum current is 115mA

The circuit should be tested per FCC 68.314 which consists of a battery and variable resistor to simulate proper operation at the above stated conditions.

DC Characteristics (Figure 2)

The electronic inductor should be tailored to meet the following requirements:

- CO (Central Office) Battery (42.5 - 56.5V DC)
- Loop Resistance (400 - 1740Ω)

Maximum allowed DC-resistance of CPE (Customer Premise Equipment) in off-hook mode (200Ω) per FCC 68.314 (c1), (c2).

Minimum recommended DC resistance in off-hook mode (90Ω) per EIA-496A, 4.2.2.1.

The two extremes of operation are as follows:

1. Minimum loop current:
 - CO battery drops to 42.5V DC
 - Loop resistance is 1740Ω
 - Electronic coil has highest DCR of 200Ω
resulting in a minimum loop current of 22mA

AC Characteristics

For good performance, the electronic inductor should emulate an inductance of between 4-10H. To approximate the value of the inductor: $L \approx R1 \cdot C1 \cdot R3$.

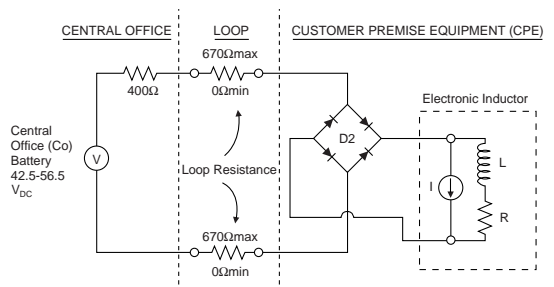

Figure 2. Central Office to CPE Interconnect

Linear Optocouplers

Appendix 2

Photoconductive Description

When the LOC is used in the photoconductive mode, the phototransistors are operated with the collector and base reversed biased as shown in figure 1A. The equivalent circuit model is shown in figure 1B which shows the photocurrent source I , dark current component I_D , intrinsic diode D , and junction capacitance C_p . The incident flux from the LED on the phototransistor causes a photocurrent (I) to flow from the collector to the base and through the load resistor R_L . This photocurrent is linearly proportional to the LED flux. The output voltage V_o results from the product of the photocurrent (I) plus a small dark current times the load resistance R_L : $V_o = [I + I_D] \cdot R_L$. The dark currents from both phototransistors track closely and are canceled when used in the servo mode.

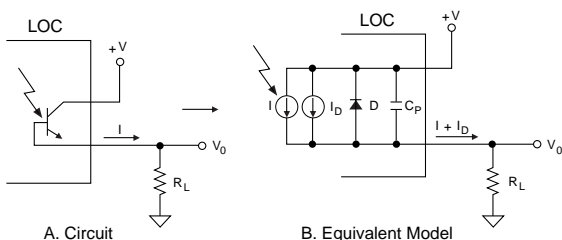

Figure 1. Photoconductive Model

One of the attributes of the photoconductive mode is a bandwidth of about 200kHz. This is considerably higher than the photovoltaic mode bandwidth discussed earlier which was around 40kHz. One of the reasons for this is that with the photoconductive mode, since the base-collector junction is reversed biased, the depletion area

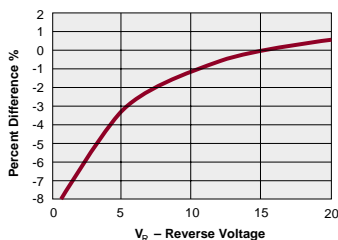

Figure 2. Photoconductive Responsivity

of the junction is wider than when no bias or forward bias is applied. The wider depletion area of the junction results in a lower junction capacitance (C_p in figure 1B) which results in a faster rise time or responsivity:

$$t_R = R_L \cdot C_p$$

As the magnitude of the reverse bias is increased, the depletion width of the junction gets wider resulting in lower junction capacitance C_p .

The responsivity of the phototransistor in this mode is shown in figure 2. Note that the responsivity decreases only 3% from a +V of 15V to 5V.

Photovoltaic Description

When the LOC is used in the photovoltaic mode the phototransistors are operated with the collector and base forward biased. Figure 3 shows a typical circuit with a simplified model. In this mode the phototransistor has no external power source available to it like in the photoconductive mode where there was a +V source at the collector. Instead, the phototransistor delivers power to an external load, R_L , in response to the LED emission. Since there is no external power source connected to the phototransistor there is no dark current.

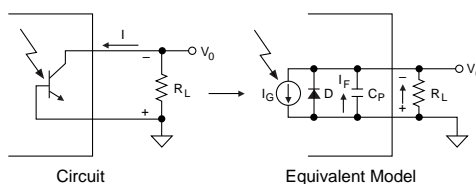

Figure 3. Photovoltaic Model

Referring to figure 3, as the current I increases with an increase in incident LED flux, a voltage is developed across R_L . This voltage however becomes increasingly nonlinear as more current (I_F) begins to flow through the intrinsic diode D or as R_L is increased in value. This can be illustrated by looking at a simplified equation of the current flow through the junction. The total current consists of two parts, one part is the current that flows through the intrinsic diode I_F , the other is the photogenerated current from the LED flux I_G :

$$I(\text{total}) = I_F - I_G$$

I_F can be expressed with the diode equation:

$$I_F = [I_s (e^{\frac{V_O}{K}} - 1) - I_G]$$

the total current can be expressed as:

$$I_F = I_s (e^{\frac{V_O}{K}} - 1)$$

As R_L approaches 0Ω the output voltage V_O approaches $0V$ at which time the diode term for the current equation drops out and the total current is equal in magnitude to the photogenerated current I_G which is linearly proportional to the incident LED flux:

$$I(\text{total}) = I_G \text{ with } R_L = 0\Omega$$

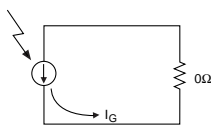

Figure 4. Equivalent Circuit with $R_L = 0\Omega$

The equivalent circuit with $R_L = 0\Omega$ is shown in figure 4. To achieve $0V$ bias, the configuration shown in figure 5 is implemented. The inverting input of the amplifier is at virtual ground so a $0V$ bias is obtained. When LED flux is incident on the phototransistor, a current is generated by the phototransistor and pulled from the inverting input. Since by Kirchoff's law the sum of the currents entering and leaving a node must be zero, the amplifier responds with a current I_1 of equal magnitude to the current leaving the node I_G , and is injected into the inverting node via R_F which maintains zero volts at this node. The output voltage of the op amp is the current $I_1 \cdot R_F$.

The junction capacitance is higher than in the photoconductive configuration due to a zero volt bias which results in a narrower depletion region and a higher junction capacitance which limits the bandwidth to approximately $40kHz$.

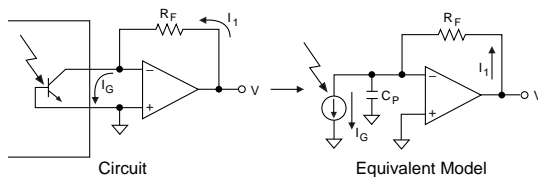

Figure 5. Implementation of $0V$ Bias in Photovoltaic Mode

Variable Speed Controllers

Variable-Speed Motor Controller Design Utilizing the LOC110

The Application

Variable speed controllers regulate the speed and/or torque of asynchronous motors. Depending on the application, there are controllers from a few hundred Watts up to several hundred kWatts. These speed controllers must conform to international standards and operate in industrial environments which are subject to high-energy overvoltages (surges), phase failure, overvoltages, undervoltages and supplies with high levels of noise interference. It is in this type of environment that the LOC110 linear optocoupler from CP Clare excels. The LOC110 is a linear optocoupler that provides $3750V_{RMS}$ input/output isolation with a high CMRR and high noise rejection ratio.

The Circuit

In the photovoltaic mode (figure 1) it is possible to get up to 12 bits resolution from the voltages you want to monitor on your attached microcomputer or personal computer, which can be remote. The output voltages, of course, are completely isolated from the mains.

When we look at figure 1, L1, L2 and L3 are the incoming line voltages up to $240 V_{RMS}$ referred to the N (neutral) wire. These line voltages are the same for the upper and the lower circuit. (They are only separated for better understanding of the circuit).

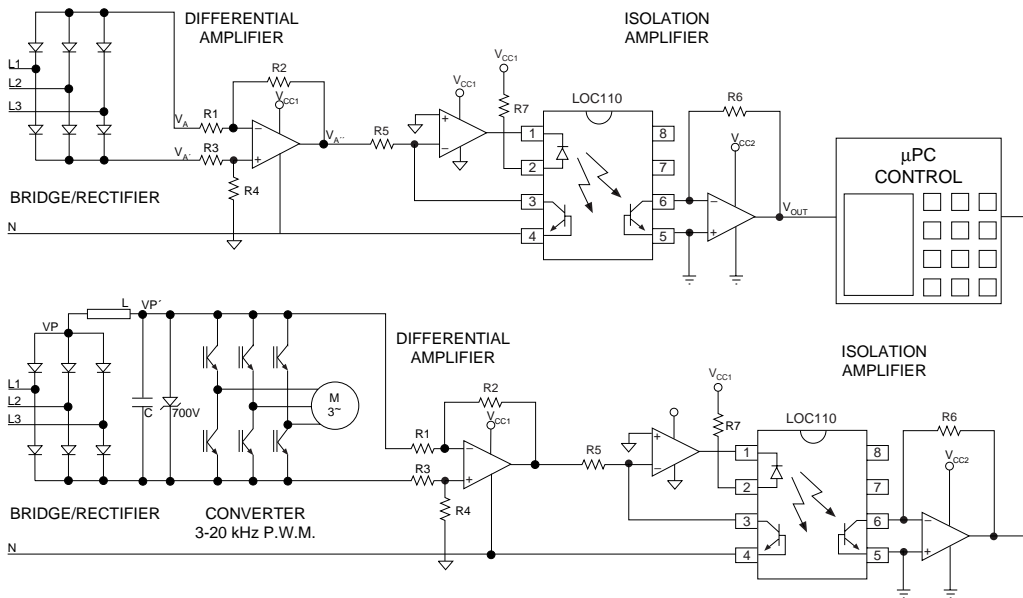

Figure 1

Variable Speed Controllers

The upper part monitors the line voltages and the (absence of) phases.

The line voltages are rectified with a bridge (figure 2). The high voltage between $V_{A'}$ and V_A is converted to a lower voltage with a differential (instrumentation) amplifier. The difference in voltage between $V_{A'}$ and V_A is $590V_{PEAK}$.

The output of the differential amplifier is found to be:

$$V_{A''} = \frac{R_4}{R_3 + R_4} \cdot \left(1 + \frac{R_2}{R_1}\right) \cdot V_{A'} - \left(\frac{R_2}{R_1} \cdot V_A\right)$$

if $\frac{R_4}{R_3} = \frac{R_1}{R_2}$, then it follows $V_{A''} = \frac{R_2}{R_1} \cdot (V_{A'} - V_A)$.

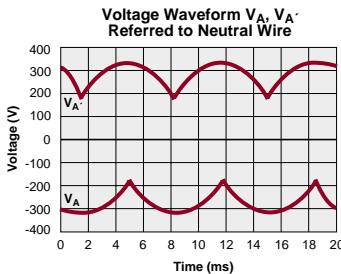

Figure 2

In our example (figure 3) we used $1M\Omega$ for R_1 and $15K\Omega$ for R_2 .

Voltage $V_{A''}$ goes to the isolation amplifier (figure 4).

The isolation amplifier is configured in the photovoltaic mode. Whenever you need a bandwidth not greater than 40kHz this is always the best configuration. This is mainly due to the fact that there are no dark currents in this mode, since there is no external power source connected. In the photovoltaic mode, the LOC110 phototransistors act as current generators. The LED flux is incident on the servo phototransistor which starts current I_1 to flow from the op amp inverting input through the phototransistor. This servo photocurrent generated is linearly proportional to $V_{A''}$, $I_1 = V_{A''}/R_5$ in order to keep the voltage on the inverting input equal to zero. The flux from the LED is also incident on the output phototransistor which causes a current I_2 to flow from the inverting input of the output op amp through the phototransistor. As I_2 is pulled from the inverting node,

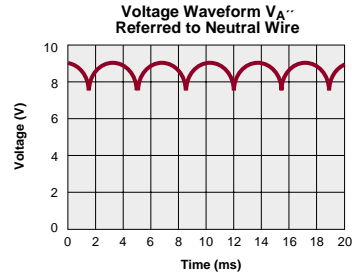

Figure 3

the output of the amplifier begins to go high until a current equal in magnitude to I_2 is injected into the inverting node of the amplifier. Since this current I_2 flows through R_2 an output voltage is developed such that $V_{OUT} = I_2 \cdot R_6$. V_{OUT} is also equal to $V_{A''} \cdot K_3 \cdot R_6 / R_5$. Depending on the bin number (A to J) you receive, an LOC has a K_3 varying from 0.55 to 1.426. K_3 is the transfer gain K_2/K_1 where K_1 is the servo gain I_1/I_F and K_2 is the forward gain and I_F is the LED current flowing.

The lower part of the circuit (fig. 1) monitors the power bus voltage (about 600 VDC).

The line voltages are again rectified, but instead of a few mA's, currents up to several hundreds of Amperes are flowing. The ripple of voltage V_P is rejected through the LC low pass filter. The voltage V_P' is the actual power bus voltage. The zener diode is used to protect the capacitor from overvoltages when the machine suddenly reduces speed (brakes). The circuit after the zener diode represents the control circuit for the Pulse Width Modulation with modulation frequencies K_3 mostly used somewhere between 3 and 20 kHz.

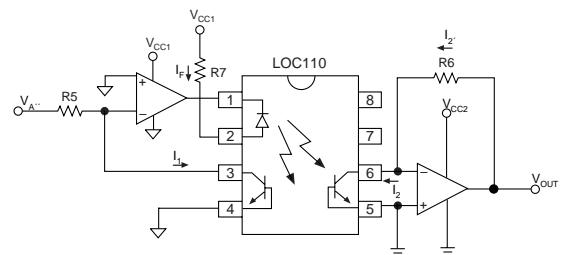

Figure 4

Medical Applications

Isolation Amplification

Those of us getting on in years are probably quite familiar with the electrocardiogram and the hassle of being wired up like some laboratory animal or car battery. What we may not be aware of though, is the technical sophistication which goes into the design of a device dealing with cardio signal measurement. To elaborate, the human heart emits signals which are approximately 1mV in magnitude, while those from the heart of an unborn baby can be on the order of .050mV (compare this to the basic light bulb which operates from 220V (120V) or 220.000mV (120,000mV)). Since these signals are very minute in amplitude, noise such as residual electrode voltages and 50Hz (60Hz) power line pickup can easily swamp out the signal being sensed by a probe. Therefore, an application such as this one requires an isolated amplifier circuit, which has a high common mode rejection ratio (CMRR), interfacing to the probe. This serves to reduce the common mode noise while providing amplification for the heart signals. CP Clare, a world leader in semiconductor solutions, currently has two (2) innovative devices in its arsenal which were created to assist design engineers in situations like this.

Enter the LOC...

The first component for battling common noise phenomena is CP Clare's LOC110. It is available in an 8-pin through hole DIP, trim and formed gullwing, or the revolutionary flatpack (half-height) package. With the proper support circuitry, the LOC can discretely provide the isolation, amplification, linearity, and high CMRR that is necessary, eliminating otherwise bulky and cumbersome transformers. Figure 1 shows a block diagram for the setup and function of cardio signal

measurement equipment. The isolated amplifier portion contains the LOC110 and high CMRR operational amplifiers. The electrodes are connected to the amplifier via shielded cable to provide noise immunity. The shield is connected to the patient's right leg for best CMRR performance. Figure 2 shows the placement of the LOC110 in a typical isolated circuit.

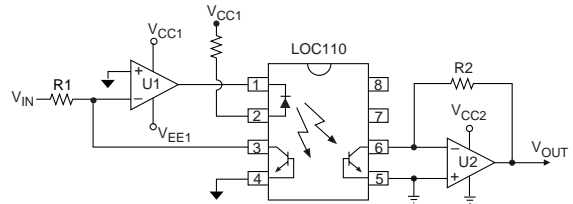

Figure 2

For those who wish to reduce their design even further, CP Clare now offers the all new LIA100 (16-Pin DIP) or LIA100P (16 Pin SOIC). The LIA series is the complete solution in Linear Isolation Amplifiers. The design includes the LOC110 linear optocoupler, but continues a step further and adds the high CMRR operational amplifiers in the same package, thus reducing the design engineer's component search.

Conclusion

Compared to the competition, the LOC110 has a much lower harmonic distortion level when an identical input signal is used. As for the K3 temperature coefficient for the LOC110P, it stands strong at 0.005%/°C. With such low distortion levels and impressive stability over large temperature variation, it's easy to see why the LOC (and/or LIA) series are the "Clare" choice.

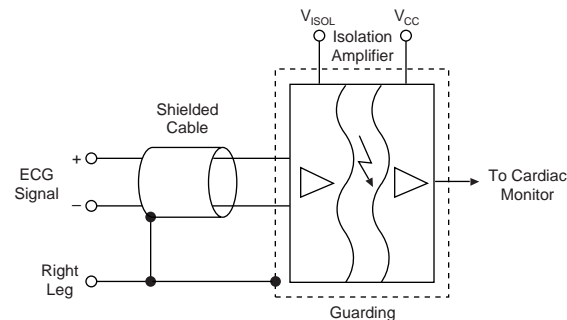

Figure 1

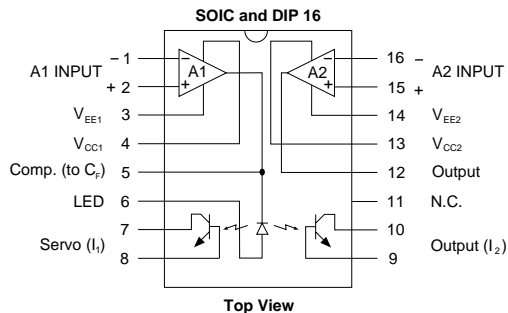

Figure 3. LIA100

Isolated 0-10V to 4-20mA Converter Application



Industrial controllers and data acquisition equipment frequently require an isolated voltage-to-current loop converter in environments where high common mode noise exist and protection of equipment and personnel from high voltages are required. The current loop, usually 4-20mA, is used to drive control valves or the input to chart recorders for temperature/pressure monitoring over time for example. Figure 1 shows a simplified block diagram of an isolated pressure transmitter.

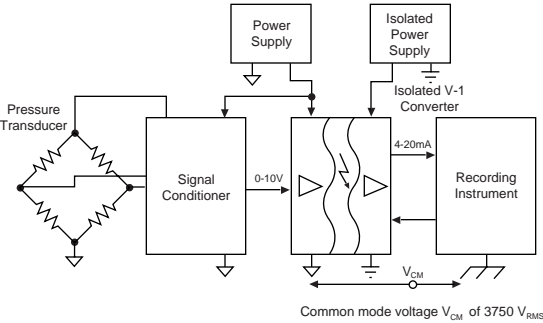

Figure 1. Isolated Pressure Transmitter

The LIA100P, with a typical Common Mode Rejection Ratio of 130dB (see figure 1A) and isolation voltage up to 3750V_{RMS} is a good choice for this kind of application.

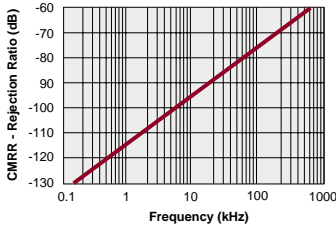

Figure 1A. Common Mode Rejection

The example circuit for this application is shown in figure 1B.

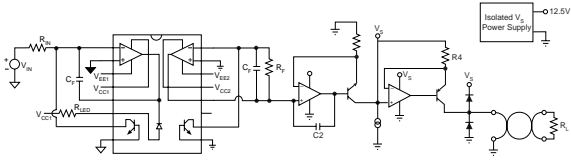

Figure 1B. 0-10V to 4-20mA Converter

The LIA110P is in the photovoltaic mode which has linearity comparable to a 13-14 bit D/A converter with 1 LSB nonlinearity or 0.01% of full scale. The result is a clean, linear conversion from 0-10V to 4-20mA as shown in figure 2.

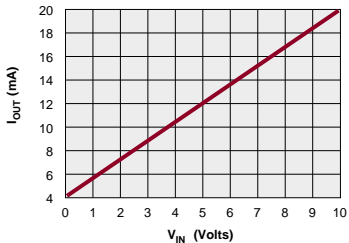

Figure 2.1 I_{OUT}(mA) vs. V_{IN}(Volts)

PLCA110 Solid State Relay and Surge Arrester

Introduction

This application note describes the advantages of using CP Clare's PLCA110 integrated Solid State Relay and Solid State Surge Arrester (SSSA). The combination of these discrete components in one package allows a single 8 pin device to serve both functions, while providing the advantages of reduced pc board space and 3750V_{RMS} input/output isolation, meeting FCC Part 68 requirements¹. In addition to providing a complete overview of the PLCA110, this Application Note describes its use for telecommunication applications in accordance with agency (UL, CSA, BSI, etc.) requirements.

Description

The PLCA110 is an integrated Solid State Relay and Solid State Surge Arrester for use in AC or DC circuits where switching and protection against excessive line transients are required. The relay portion of the device consists of an infrared LED optically coupled to a photovoltaic chip which in turn drives two (2) enhancement mode MOSFET chips. By packaging the Solid State Relay and Surge Arrester together extra components are eliminated, which both decreases required pc board space and improves system reliability.

Circuit Operation

When using the PLCA110 in a typical application, the relay side of the device will supply fast, reliable SPST solid state switching while the surge arrester will provide the necessary protection against line to line transients (metallic) which would damage circuits under normal conditions. Figure 1 shows PLCA110 placement in a typical telecommunications circuit. The connection of the tip and ring lines may be made to either pin 5 or 6 since the unit is bidirectional; both lines will be protected from line to line pulses or transients. Since Pin 6 has one wire of the telephone circuit connected to it (hookswitch input) the circuit can be completed by placing the hookswitch output to pin 8.

As illustrated in figure 2, normal circuit operation is allowed as long as the voltage across the SSSA does not exceed a particular maximum value (V_{BO}).

¹There are obvious limits to the surge pulse, but the PLCA110 is designed to be fully compliant with FCC Part 68 requirements.

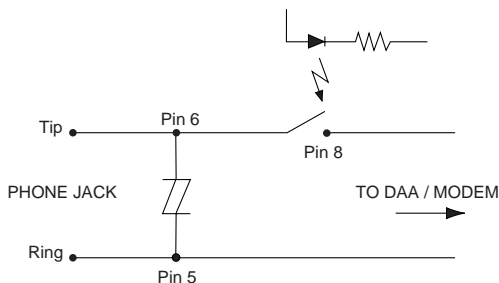

Figure 1. Typical Telecommunications Application

Under normal operating conditions, the circuit sees the SSSA as an open circuit. When a surge is impressed across the circuit, the voltage across the SSSA rises, usually quite rapidly. Upon reaching the breakover voltage (V_{BO}), the SSSA goes into a zener mode, which holds the voltage at a constant level (V_Z). Under these conditions, the current begins to rise. Once it reaches its breakover point (I_{BO}), the SSSA switches to a low impedance state and acts like a “voltage crowbar.” This drops the voltage across the device to approximately $\pm 3V$ maximum (V_T). The SSSA remains in the ON state as long as the voltage across the SSSA exceeds the breakover voltage. As the surge subsides, the current drops to holding current value (I_H) of the SSSA, which switches to the OFF state, becoming a high impedance (open circuit) to the circuit until the next surge is sensed.

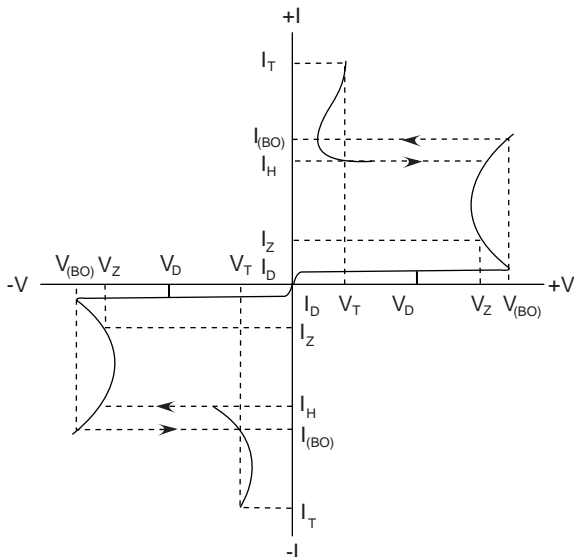

Figure 2. Transfer Characteristics of the SSSA

PLCA110 Solid State Relay and Surge Arrester

The SSSA within the PLCA110 can withstand the metallic surge pulse waveform which is defined by FCC Part 68 requirements. Figure 3 below depicts the waveform specification in graphical form, which is an 800V peak-surge, with a maximum risetime to crest of 10 μ s and a 560 μ s minimum decay time to halfcrest.

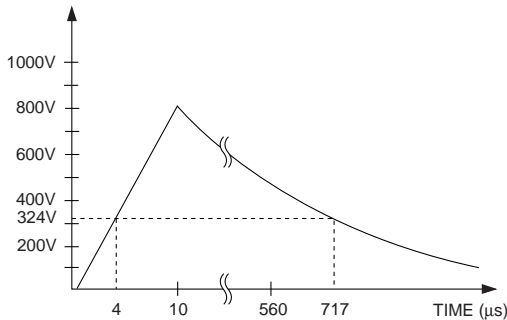

Figure 3. Metallic Surge Pulse Waveform

Why Use A Solid State Surge Arrestor?

Surge protection, although not always required by federal regulations, can be vital in protecting electronic circuits from line disturbances. These disturbances are referred to as transients, surges, glitches, or spikes. Without warning, these glitches will often damage equipment or cause major malfunction. The degree of damage can vary from data loss to the total destruction of the electronic equipment. Equally destructive are transients inflicted on telecommunication lines, which in addition to damaging expensive telephone equipment, can often place an end user in considerable danger. In order to avoid equipment damage or dangerous conditions, various devices are employed to protect the equipment and users from transient conditions, including:

- Solid State Surge Arrestor
- Varistor/MOV (Voltage Dependent Resistor)
- Gas Discharge Tube (GDT)

Each device has advantages and disadvantages.

Solid State Surge Arrestor — The SSSA functions as a voltage controlled “crowbar/foldback” device. When activated, it will switch from a “high off state resistance” to essentially become a short circuit. It will continue in

this state until the current flowing through it is less than the minimum holding current for the SSSA, at which time it will reset itself. Since it can withstand high currents, delatching is guaranteed once the surge has subsided. It is extremely reliable and offers these advantages over other types of protection:

- Can be used in AC or DC applications
- Fastest response time of any device
- No moving parts
- Lower leakage current than other means of surge protection
- Lower power dissipation
- Tighter defined clamping voltage
- Non-degenerative
- Only device available that can exceed 268V FCC ringing requirements and protect a component rated at 350V

Varistor/MOV — MOV’s are usable in both AC and DC applications because of their electrical symmetry. Although their response time is comparable to the SSSA, they will degrade over time depending on the energy level, surge duration and frequency of occurrence. Physically they are large in size and their electrical design results in wide variations of clamping voltage. This is proven by the fact that surges from low impedance sources are allowed to leak at higher voltages at the protected connections than other devices with the same voltage rating.

Gas Discharge Tubes — Gas Discharge Tubes* (GDTs) are cylindrical tubes filled with compressed gases. Once a breakdown voltage has been reached, an electrical arc forms internally (gas ionization), providing a path to consume the surge. Mainly used as primary protection in telecom circuits, designs can actually benefit by using them in conjunction with the SSSA. This is due to the ability of the gas tubes to sink extremely high amounts of current and therefore take the brunt of the surge. Because of their slower response time, more loosely defined specifications, and dependency of the breakdown voltage to the rate of rise of the transient, a more reliable design is achieved by using a SSSA and GDT in combination to realize the benefits of both devices.

*For more information on CP Clare gas tube arrestors reference CP Clare Catalog 220

PLCA110 Solid State Relay and Surge Arrester

Telecommunications Application

The PLCA110 is ideal for use in a number of telecommunication applications, including tip/ring circuits. UL1459, 2nd Ed., CSA 225 and EN60950 require telecom products to comply with the "Overvoltage" and "Fire Hazard" test, respectively.

The intent of these tests is to simulate the resultant fault in the event that power lines run alongside were to cross telephone cables and insulation breakdown was to occur. The National Electrical Code (NEC) requires protection to be provided for voltages in excess of 600V on telephone cables, but does not require anything for voltages up to 600V. Figure 4 shows a typical 2-wire telephone configuration where a 10Ω , 0.25W metal film resistor provides overcurrent protection. The PLCA110 is the perfect solution for protecting against line to line transients ($V_{BO} = \pm 283V$ minimum, $\pm 340V$ maximum) and providing the necessary SPST switching capabilities for phone operation. Not only does the PLCA110 provide real estate and cost savings, but it is an acceptable solution for meeting UL and CSA requirements in this common "metallic" surge protection application.

Summary

The PLCA110 is an effective way of combining surge protection and solid state switching in one component. The surge arrester portion is designed to protect two wire telecommunication (metallic) applications against transients caused by lightning strikes and AC power lines. In addition, it is guaranteed to suppress and withstand the listed international lightning surges in both polarities. The relay portion on the device is fast, requires little drive power, contains no moving parts and provides bounce free switching. With all these features and the confidence of solid state reliability (>15 billion cycles) the PLCA110 is the perfect device for saving board space and complying with UL, CSA, IEC and FCC agency requirements when designing telecommunication products.

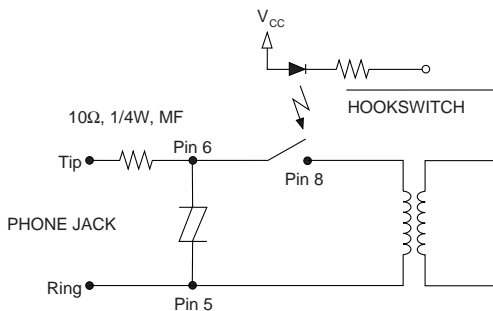
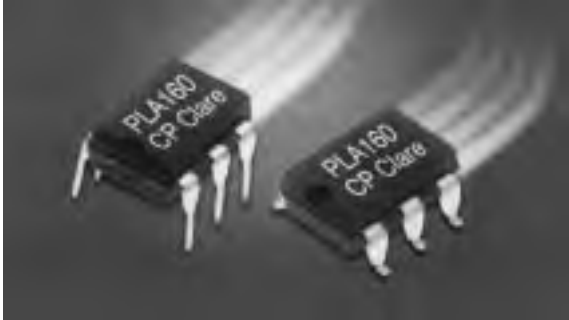

Figure 4. Typical Two Wire Application

PLA160 High Speed Switch



INTRODUCTION

This application note describes CP Clare's PLA160 High Speed Solid State Switch and outlines some major features and benefits of using this device. It will briefly describe some circuits the PLA160 was designed to be used in. The intent is to provide a better understanding of how this device works and how it can be utilized. In many industrial/data acquisition applications a low leakage, low output capacitance switching device is needed. Signals from these systems tend to be small in magnitude and can be interfered with or distorted very easily by common noise. CP Clare's PLA160 was developed to provide the switching characteristics that are required by these applications utilizing the latest, high-speed, low output-capacitance MOSFET technology.

DESCRIPTION

The PLA160 is an optically coupled MOSFET (1-Form-A) Solid State Relay (SSR), which utilizes the latest MOSFET technology to provide a fast, reliable and accurate means of switching. Packaged in a 6 pin DIP or gull wing SMD, the PLA160 provides a solution for multiplexer designs, scanners, process control applications and many other applications where a high speed solid state switch is necessary. Specifications for the PLA160 are as follows:

- Peak Load Voltage (V_L) = 300V
- Load Current (I_L) = 50mA
- On-Resistance (R_{DS}) = 100 Ω
- Switching Speeds
 - T_{ON} = 50 μ s
 - T_{OFF} = 50 μ s
- Low Output Capacitance (C_{OUT}) = 3pF (Typical)

*NOTE: ALL VALUES ARE MAXIMUM VALUES-Except where noted.

USING THE PLA160

The PLA160 is a normally open 1-Form-A SSR. Switching speeds have a maximum value of 50 μ s using an input control current (I_F) of 10mA at an ambient temperature (T_A) of 25 $^\circ$ C. Figures 1 and 2 show the respective turn-on (T_{ON}) and turn-off (T_{OFF}) times over the entire operating range.

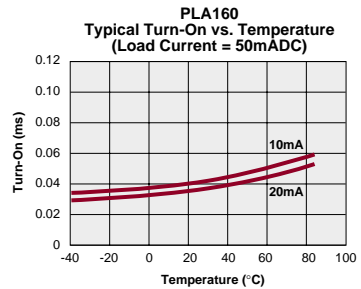

Figure 1.

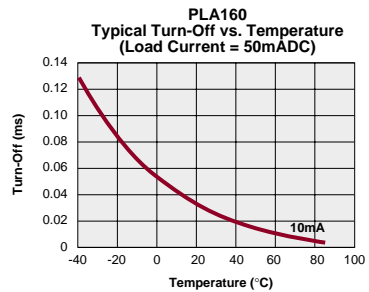

Figure 2.

Figure 3 shows how the T_{ON} and T_{OFF} speeds are derived.

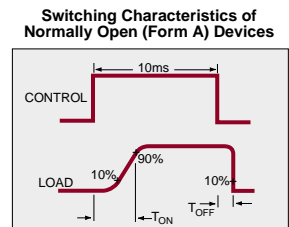

Figure 3.

To guarantee the performance specifications of this device, the input control current (I_F) must be a minimum of 10mA at an ambient temperature (T_A) of 25 $^\circ$ C. The input of the PLA160 uses two light-emitting diodes

PLA160 High Speed Switch

(LEDs) connected in series from pin 1 to 2. Each LED has a typical forward voltage drop of 1.4 volts with $I_F = 10\text{mA}$ thus 2 LEDs in series will drop 2.8 volts. A suitable current limiting resistor (R_{LED}) must be determined to maintain $I_F = 10\text{mA}$ minimum at $T_A = 25^\circ\text{C}$. Figure 4 shows the series circuit for determining R_{LED} . Using a loop equation yields:

$$V_{CC} = I_F * R_{LED} + V_{LED}, \quad V_{CC} - V_{LED} = I_F * R_{LED},$$

$$R_{LED} = (V_{CC} - V_{LED}) / I_F$$

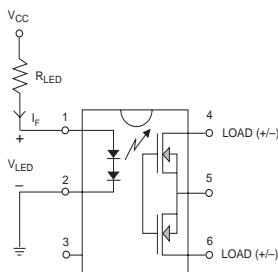

Figure 4.

With $I_F = 10\text{mA}$ at $T_A = 25^\circ\text{C}$, the PLA160 will guarantee $50\mu\text{s}$ T_{ON}/T_{OFF} switching speeds maximum. If higher temperatures are involved, a higher LED drive current will be required to compensate for the LED temperature coefficients. Refer to the PLA160 Performance Specifications for the appropriate data.

Multiplexer Designs

Multiplexer designs typically require low leakage current circuits due to the low level signals which they are required to switch. By providing a low capacitance device, CP Clare can practically eliminate leakage currents and provide the instrumentation and data acquisition design engineers with a device that can switch low level signals with little to no signal loss.

SSRs provide many different advantages over electro-mechanical relays (EMRs) regarding multiplexers. In the past, multiplexers typically used EMRs opposed to SSRs. EMRs had been used for several years and their functionality was well understood making them ideal for multiplexers. At the same time SSRs were fairly new in the marketplace and developers had a questionable understanding of their functionality.

Since the advancements in MOSFET technologies, many of the SSR characteristics have changed

dramatically; low output-capacitance, low leakage currents, faster speeds, and virtually no offset voltage make the newer SSRs perfect for multiplexer applications.

CP Clare's PLA160 was developed to meet the electrical requirements for multiplexer applications. By using the PLA160, the design engineer is able to create more reliable and better performing systems, in a smaller amount of space. Some advantages using SSRs in multiplexer designs are outlined below:

- Low Thermal Offset Voltage - Solid state relays typically have a thermal offset voltage of less than 0.2 microvolts.
- Low Power Consumption - PLA160 = 28mW of power ($2.8\text{V} (V_{LED}) * 0.01\text{mA} (I_F)$)
- Speed - CP Clare's PLA160 has switching speeds of $50\mu\text{s}$ maximum. Close to 15 times faster than ordinary EMRs. This low speed enables higher scanning rates.
- Small Size - The small size of SSRs enables designers to "pack" more channels per board.
- The Lack of Crosstalk - SSRs are insensitive to magnetic fields; Operating SSRs will not interfere with each other. Designers can add more devices per board allowing for increased functionality.
- Long Life - SSRs typically have a life expectancy greater than 15 billion operations. SSRs are immune to shock and vibration (due to no moving parts).

A multiplexer is defined as a device that receives data over several different channels and processes this information in an orderly fashion. The data can be processed by an amplifier or other microprocessor. When the order of the channels is sequential, it is usually referred to as a scanner. If the order of selection is random it is usually referred to as a multiplexer. Figure 5 shows a typical multiplexer circuit. In this particular application, 3 poles are required per sensor with an additional 3 poles for the group select. This enables each channel to be connected to the signal and the shield or guard to be connected to the processing equipment. In this particular case the measurement system is a high gain amplifier, sample/hold and an A/D converter.

Flying Capacitor Multiplexer

Flying capacitor multiplexers have been used in the industry for a number of years. Being one of the most effective ways of switching low level signals, a flying capacitor multiplexer offers high common mode rejection and isolation of the common mode source from the measurement system. In a flying capacitor

PLA160 High Speed Switch

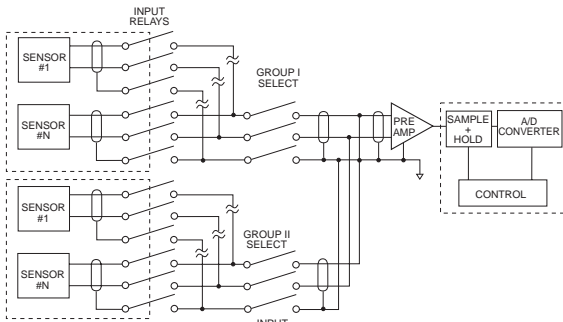

Figure 5.

multiplexer, two pairs of switches are required per channel along with a capacitor as shown in Figure 6. A low leakage, low output capacitance switch is required to accurately switch these signals. Switches used in flying capacitor multiplexers typically meet the following:

- Minimum of 1000 Volts isolation
- Fast T_{ON} and T_{OFF} times
- Low DC and AC signal error
- Long life

Flying capacitor multiplexers allow accurate multiplexing of low voltage (millivolts), low frequency signals from thermocouples and other similar sensors with accompanying high common mode voltages. As shown in Figure 6, closing relays X will charge up the capacitor C to the voltage from the sensor. Thus, C acts as a simplified sample and hold circuit. Opening relays X and closing relays Y (in a break-before-make fashion) place the sampled signal on the input of the op-amp circuitry.

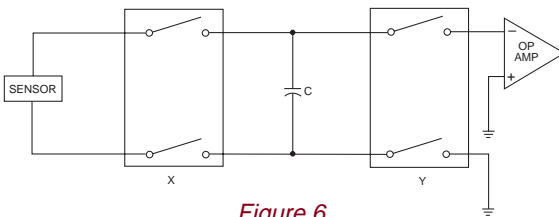

Figure 6.

Input Selector

Figure 7 demonstrates using the PLA160 as an input selector or summing amplifier. Typically these signals are low and need to be amplified.

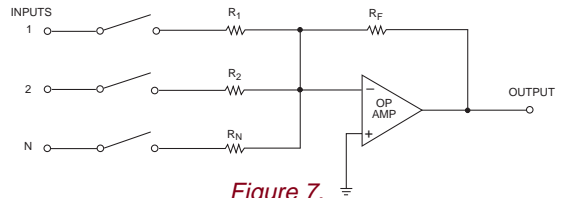

Figure 7.

The PLA160 can also be used in an amplifier gain switching arrangement. Figure 8 illustrates the inverting amplifier version. The voltage gain of this configuration is:

$$V_{OUT}/V_{IN} = - (R_{FEQ}/R_{INEQ})$$

where R_{INEQ} and R_{FEQ} are the equivalent resistances for the input and feedback resistive networks respectively.

$$R_{INEQ} = R_{IN} * R_{SEQ} / (R_{IN} + R_{SEQ})$$

$$R_{SEQ} = (R_1 + R_{DS1}) * (R_2 + R_{DS2}) / (R_1 + R_2 + R_{DS1} + R_{DS2})$$

$$R_{FEQ} = R_F + [R_3 * R_{DS3} / (R_3 + R_{DS3})] + [R_4 * R_{DS4} / (R_4 + R_{DS4})]$$

Use these equations for determining the equivalent resistances with $R_{DS} = 100\Omega$ maximum for the PLA160 when the switch is closed (LED is driven). For determining the resistance with the switch open, $R_{DS} \sim$ infinite ($12 \times 10^9 \Omega$).

CONCLUSION

Whether it is a multiplexer, data acquisition, or other instrumentation application, the PLA160 is an ideal device for the switching requirements. With very low leakage current and fast switching speeds, the PLA160 was designed for applications that require sensitivity and fast switching. In such designs as the amplifier gain switching circuit, it is absolutely necessary to have low leakage and low capacitance. Because the signals are so small in magnitude, low leakage is critical. As in multiplexer designs, all of the above features are also critical. CP Clare provides the solutions for your industrial, instrumentation and data acquisition applications.

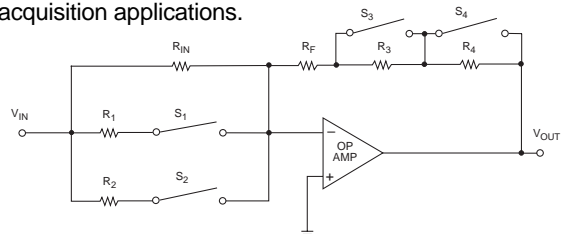

Figure 8.

TS117 Telecom Switch

SSRS FOR MODEMS

The use of relays in telecom circuits has a long history. Originally, electromechanical relays were the only viable solution for these applications. However, as modems, automatic telephone dialers, fax machines and answering machines continue to expand in the data processing world, the need for state of the art technology in the form of solid state relays (SSRs) has become apparent.

The SSR offers: High Blocking Voltages, High Load Currents, Low On-Resistance, Fast Switching Speeds and Input/Output Isolation of $3750 V_{RMS}$, which make them an ideal solution for hookswitch, pulse dialing or loop start switching operations.

Essentially, the modem begins in a standby or idle state in which it is disconnected from the telephone line (See Figure 1). Connection begins when a ring current is detected by the ring detection device (CP Clare: LDA Series or "TS" Series). This device supplies a ring detection signal to the modem circuit which is used to initiate the answer response mode. Once the ring detection signal is recognized and has initiated the answering sequence by generating the ringing indication signal, the modem chip responds with a signal. The off hook signal generated by the modem is used to activate the hookswitch solid state relay (CP Clare: LCA or PLA Series), closing the circuit between the tip and ring wires and connecting the modem to the circuit.

CP Clare offers a wide range of SSRs for the telecom industry. Form A, B, C, single pole or dual pole devices, detailed specifications of which are found on pages 91-282.

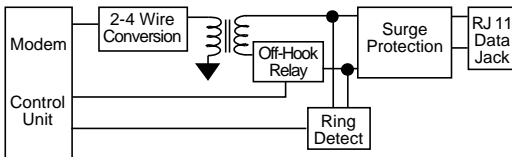

Figure 1. Typical Modem Circuit

Figure 2 is a typical data access arrangement (DAA) design using CP Clare's "TS" Series SSR. The "TS" Series offers an optically isolated normally open (or normally closed) MOSFET based solid state relay, combined with a bi-directionally driven photo-transistor, all in the same 8 pin DIP.

The Ring Detection portion of this circuit uses a capacitor (typical value $.68\mu F$) and a resistor (typical value 10K Ohms) in a series with the bi-directional LEDs of the TS117, across the Tip and Ring lines of the circuit.

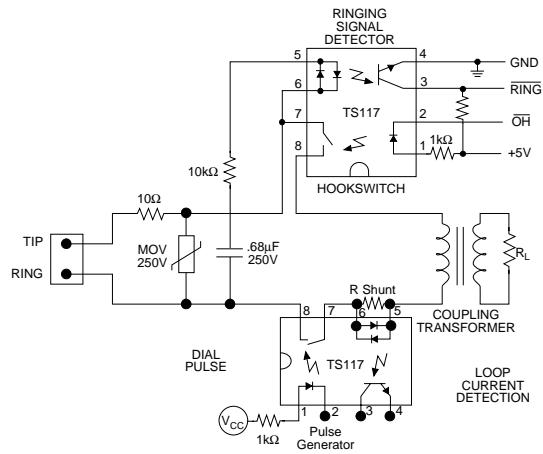

Figure 2. Ring Detector and Loop Detector Circuit

The resistor and capacitor values for the circuit must be chosen to provide sufficient current to operate the detector portion of the TS117 at the required voltage of the ringer service. (For Class B ringer service voltage range of 40 to $150V_{RMS}$ and frequency range of 15.3 to 68Hz.)

The impedance of this resistor/capacitor network is critical to the Ringer Equivalence Number (REN). The smaller the impedance the larger the REN and if the REN is too large it will limit the number of telephone devices that can be attached to the line.

The TS117 is sensitive to typical loop currents of 2mA allowing the circuit designer the freedom to program the actual in-circuit triggering current by appropriate choice of input shunt resistance.

ITC117P Integrated Telecom Circuit

CP Clare's Integrated Telecom Circuit (ITC117P) features combined circuitry in one 16 Pin SOIC package for:

- 1-Form-A Solid State Relay for use as Hookswitch
- Bridge Rectifier
- Darlington Transistor
- Optocoupler that can function as a ring detector or loop current detector

Typical applications for the ITC117P include:

- PCMCIA Designs
- Modem
- Fax
- Voicemail Systems
- Telephone Sets
- Computer Telephony

DESCRIPTION

The ITC series integrates the major components found in a typical Data Access Arrangement (DAA), in a 16 lead SOIC package. As highlighted in figure 1, the 1-Form-A MOSFET SSR, Darlington transistor, bridge rectifier, and optical isolator comprise this integral design. Following is the functional explanation for each device:

Hookswitch - The ITC contains optically-coupled MOSFETs that function as a hookswitch in the DAA circuit. The hookswitch has a blocking voltage up to 350V, isolation voltage to 3750V_{RMS}, 15Ω RDS(on), and a maximum switching current of 120mA, making it ideal for Tip and Ring switching. The hookswitch is controlled by an LED that requires only 5mA to operate. This makes it an attractive device for battery-powered applications where power consumption needs to be minimized for prolonged battery life.

Optocoupler - An optocoupler is included in the ITC series package that can be used as a ring detector or loop current detector with the addition of a few passive components. The optocoupler is available with a standard phototransistor or a high gain Darlington transistor.

Bridge/Darlington - Referring to figure 2, a bridge rectifier (D2) and Darlington transistor (Q1) arrangement is included in the package for use in "dry" transformer and optical DAA designs. The bridge provides the function of current steering to maintain DAA operation and protect the Darlington during polarity reversals of Tip and Ring wires. The Darlington, with the addition of a few passive components, functions as an electronic inductor that has the effect of presenting a low resistance to the DC current across the telephone line, and a relatively high impedance for AC signals on the line. For a transformer based design, this enables the designer to use a small coupling transformer (T1) since the telephone loop current is diverted through the Darlington instead of the transformer windings ("dry transformer"). Without the electronic inductor, the loop current would have to flow through the transformer ("wet transformer"), however, since the telephone loop current can be as high as 120mA, the transformer would saturate, causing signal degradation unless the geometry of the transformer becomes much larger. This is especially true for high speed modems such as V.34bis, where return loss must meet or exceed 25dB. Return loss of 25dB is usually not attainable with a wet transformer, and if it is, the transformer is too large and expensive for the application. *The best way to overcome this saturation and return loss problem is to "reroute" the loop current through the electronic inductor and AC couple the modem signal via C2 to the transformer, such that no DC current flows through the

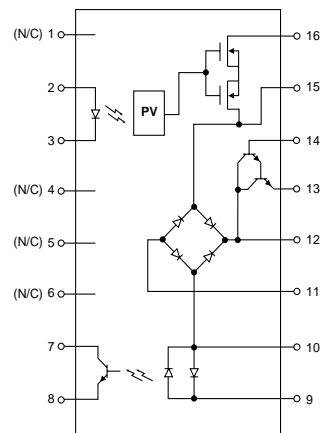

Figure 1. 16 Pin SOIC Package

ITC117P Integrated Telecom Circuit

transformer. Return loss is a measure of mismatch between the terminating impedance and the line impedance, and can be determined from the following equation:

$$\text{Return Loss (dB)} = 20 \text{ Log } [(Z_L+Z_0)/(Z_L-Z_0)]$$

* The ITC series can also be used with optically coupled DAAs such as those using CP Clare's linear optocoupler (LOC series). Since the LOC eliminates the transformer, the bridge Darlington's function is to sink loop current, thereby seizing the phone line when going offhook and presenting a high AC impedance across the phone line. For additional design information on the electronic inductor, see the "Electronic Inductor Design" section of this application note.

ELECTRONIC INDUCTOR DESIGN

The electronic inductor approximates the operation of a discrete inductor by using a Darlington transistor, three resistors, and a capacitor. When used in a DAA application, the electronic inductor will present a relatively low resistance to DC currents, and a relatively high impedance to AC signals.

CIRCUIT DESCRIPTION

Figure 2 shows the electronic inductor in a typical telecom/datacom environment. Bridge D2 rectifies current on Tip and Ring for the electronic inductor only. This ensures line-polarity insensitivity required by most regulatory agencies. Diode D1 protects Darlington Q1 from excessive transient voltages when going offhook. The zener voltage should be less than the V_{CEO} of the Darlington (40V V_{CEO} in this case). R1 and R2 set the biasing point for Q1. C1 is used for AC rejection of signals at the base of Q1. C1 should be a good quality Tantalum rated at a minimum of 10WV. R3 is used to provide negative feedback for Q1 so that Q1 will not go into saturation over the loop current range. The AC signal path is coupled to the transformer via C2. C2 should have a working voltage of 100V, or 50V if two capacitors are used, one on each lead of the primary.

DC CHARACTERISTICS

The electronic inductor should be tailored to meet the following requirements:

- CO Battery (42.5 - 56.5VDC)
- Loop Resistance (400 - 1740Ω)

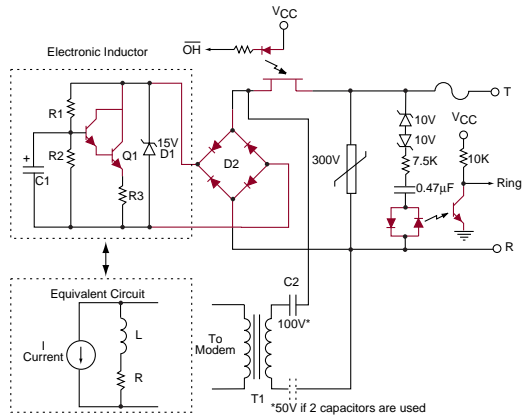

Figure 2. Typical Data Circuit

Maximum allowed DC resistance of CPE (Customer Premise Equipment) in offhook mode (200Ω) per FCC 68.314(c1), (c2).

Minimum recommended DC resistance in offhook mode (90Ω) per EIA-496A, 4.2.2.1.

The two extreme conditions of operation are as follows:

1. Minimum Loop Current:
 - CO battery drops to 42.5VDC.
 - Loop resistance is 1740Ω.
 - Electronic inductor has the highest DCR of 200Ω resulting in a minimum loop current of 22mA.
2. Maximum Loop Current:
 - CO battery is 56.5VDC.
 - Loop resistance is 400Ω.
 - Electronic inductor has the lowest DCR of 90Ω resulting in a minimum loop current of 115mA.

ITC117P Integrated Telecom Circuit

AC CHARACTERISTICS

The AC characteristics of the electronic inductor circuit should ideally be equivalent to a high value inductor (see equivalent schematic representation in figure 3) i.e. 4 - 10H for best performance. The equivalent inductance of the electronic inductor can be approximated by $L = (R1)(C1)(R3)$. The ideal electronic inductor would have infinite AC impedance and a low DC resistance, however, practical considerations such as the size of the capacitor and cost usually limit the inductance of the circuit to between 4H and 10H. It is important that the capacitor be a good quality Tantalum rated at 10V or greater. Typical capacitance values for this capacitor are on the order of about 10 μ F.

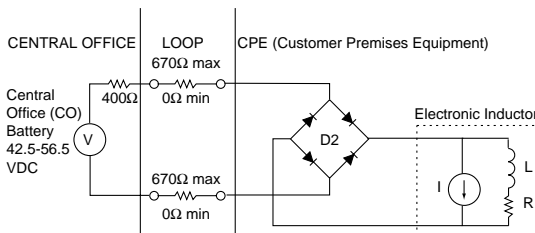

Figure 3. Typical Electronic Induction Connection to Central Office

SUMMARY

The component and functional integration that the ITC series provides makes it an attractive solution for engineers designing DAA circuitry. Some of the major advantages that the ITC provides are:

- Small SOIC package promotes a 60% overall PCB space savings over conventional discrete component designs
- Overall cost savings
- Solid State performance means increased reliability
- Provides a single component solution to a many component problem, thus reducing inventory of various components
- High isolation voltage
- Low relay drive current

In addition, the ITC series may be used in conjunction with other CP Clare Semiconductor Group Products (such as the LOC110 which is mentioned elsewhere in this application note) to provide a complete optical solution for DAA design.

Cybergate™ 20XX Series



Cybergate™ Data Access Arrangement (DAA) Module

CP Clare's Cybergate™ Series Data Access Arrangement (DAA) Module, the Cybergate, combines all of the circuitry necessary to implement a complete telephone line interface solution including:

- Low Distortion Signal Coupling (V.34 compatible)
- 1.5kV_{PEAK} Isolation
- 300V Surge Protection
- Ring Detection
- On/Off Hookswitch Relay
- Compliance to FCC Part 68
- UL1459 and UL1950 Recognized
- Half-Wave or Full-Wave Ring Detection Available
- Products covered in this application note:
 - CYG2000/CYG2001
 - CYG2010/CYG2011
 - CYG2020/CYG2021
 - CYG2030/CYG2031

Typical applications for the Cybergate Series include:

- Home Medical Devices
- Plant Monitoring Equipment
- Security/Alarm Systems
- Modems
- Utility Meters
- Voicemail Systems/Telephony Applications
- Vending Machines
- Elevator Control Boxes
- Network Routers
- PBX Systems
- PC Mother Boards
- Digital Telephone Answering Machines
- Set Top Cable Boxes

Figure 1.
Functional Block Diagram

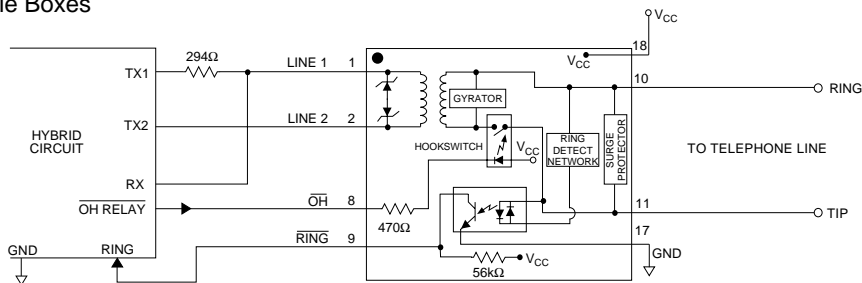

Description

The Cybergate DAA Module integrates a complete line interface circuit into a compact 1.07" x 1.07" x 0.4" package. The following is a list of major functions included in the DAA, as shown in the functional diagram in figure 1:

- Hookswitch Circuitry
- Ring Detection Circuitry
- Surge Protection
- Gyrator Circuitry
- Transformer Coupling
- Secondary Transient Protection
- Caller ID Function (optional)
- Loop Current Detection (optional)

A brief description for each of these functions follows:

Hookswitch Circuitry – The hookswitch asserts the on-hook and off-hook conditions for the phone interface (the difference between being “on-line” and “off-line”). The hookswitch is activated by the host when the host wishes to place a call or answer a call in response to an incoming ring signal. In order to perform this function in the most effective manner, the Cybergate uses a highly reliable solid state relay activated when the OH pin is driven LOW (logic ‘0’).

The current required at the input to operate the relay is 4mA minimum. The solid state relay provides no contact “bounce” and provides up to 350V blocking voltage when on-hook.

Ring Detection Circuitry – The ring detection circuitry detects the ring signal from the central office, which indicates the presence of an incoming call. This ring signal is a high voltage AC signal superimposed on the central office DC battery, nominally 48VDC. This AC signal can be at any frequency between 15.3 – 68.0Hz and have an RMS voltage between 40 and 150 volts,

Cybergate™ 20XX Series

with a typical ring cadence of 2 seconds on and 4 seconds off. The ring detection network includes an LED that emits light on one half cycle (half-wave) or both half cycles (full-wave) of the ring frequency and couples this light to an output phototransistor. The output phototransistor provides pulses from $+V_{CC}$ (via an internal 47K pull-up resistor) to ground, in response to the ring signal. These pulses are presented to the \overline{RING} pin on the Cybergate module. The duty cycle of these pulses is dependent on the amplitude and frequency of the incoming ring signal. The \overline{RING} signal is typically connected to an input port on the microcontroller or data pump located on the host system, where it is qualified as a valid ring signal.

Surge Protection Circuit – Metallic (Tip to Ring) surge protection is another key feature included in the Cybergate. All circuits function per specification under normal conditions.

Loop Current Detection – On designs requiring loop current detection, a pin, $\overline{LOOP1}$ is provided on the Cybergate. When current is placed on the loop, $\overline{LOOP1}$ will be driven low.

Gyrator Circuitry – The gyrator circuit included in the Cybergate™ provides a low DC resistance and a high AC impedance to the telephone line when the Cybergate is in the off-hook state. By doing this, the gyrator is approximating the operation of an inductor (a space saving feature as opposed to using a discrete inductor). The electronic inductor circuitry is required so that the DC current from the telephone line is diverted away from the transformer windings, thus providing the high linearity necessary for V.34 modem performance.

Transformer Coupling – A low distortion transformer is used to couple voice/data/fax signals to and from the Cybergate. The transformer provides the galvanic isolation of $1500V_{PEAK}$ required by FCC Part 68.302.

Secondary Transient Protection – Two back to back zeners are connected to the transformer secondary across LINE1 and LINE2 connections on the Cybergate. These zeners clamp any transient voltage above 5V to protect the host circuitry.

Caller ID Circuitry (optional) - The Cybergate includes two Caller ID signals, CID1 and CID2, for Caller ID applications. These two signals should be connected across a 1-Form-A solid state relay (CP Clare LCA110) which is controlled by the host microprocessor or related circuitry as shown in figure 2.

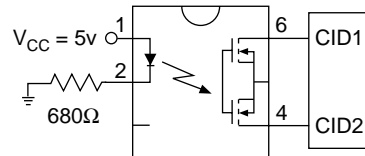

Figure 2. Caller ID Connection

Power Consumption

The Cybergate consumes very little power from the host system. This power is mainly limited to the hookswitch relay which consumes about 25mW with a $+V_{CC}$ of 5V and corresponding LED current of 4mA. $+V_{CC}$ can be greater than +5V if desired as there is an internal 470Ω LED current limiting resistor in the Cybergate. The following boundary equation should be observed, however, when selecting a $+V_{CC}$ operating voltage:

$$\{V_{CC} - 1.4V\}/470\Omega \leq 22mA$$

It is also important to note that $+V_{CC}$ should be no higher than 20V. This is because the ring detect output transistor's collector is pulled to $+V_{CC}$ via a 47K resistor. The maximum V_{CEO} of the transistor is 20V and should therefore not be exceeded.

The Cybergate module is designed to dissipate about 1.5W of power from the telephone line at a maximum ambient temperature of 70°C.

Interfacing the Cybergate to a Modem Chip

Figure 3 shows a CYG20XX connected to a Rockwell 224ATF Fax/Data modem. The 224ATF has an internal 2-4 wire hybrid that eliminates the need for an external hybrid circuit. The modem circuit shown is a 2400 bps data modem with 9600 bps fax capability. The TXA1 and TXA2 pins from the 224ATF represent the differentially driven transmit signal and the RXA is the single-ended signal from the telephone line to the modem. The 294Ω resistor from TXA1 was selected for optimum return loss by reflecting a nominal 600Ω impedance to the telephone line.

Cybergate™ 20XX Series

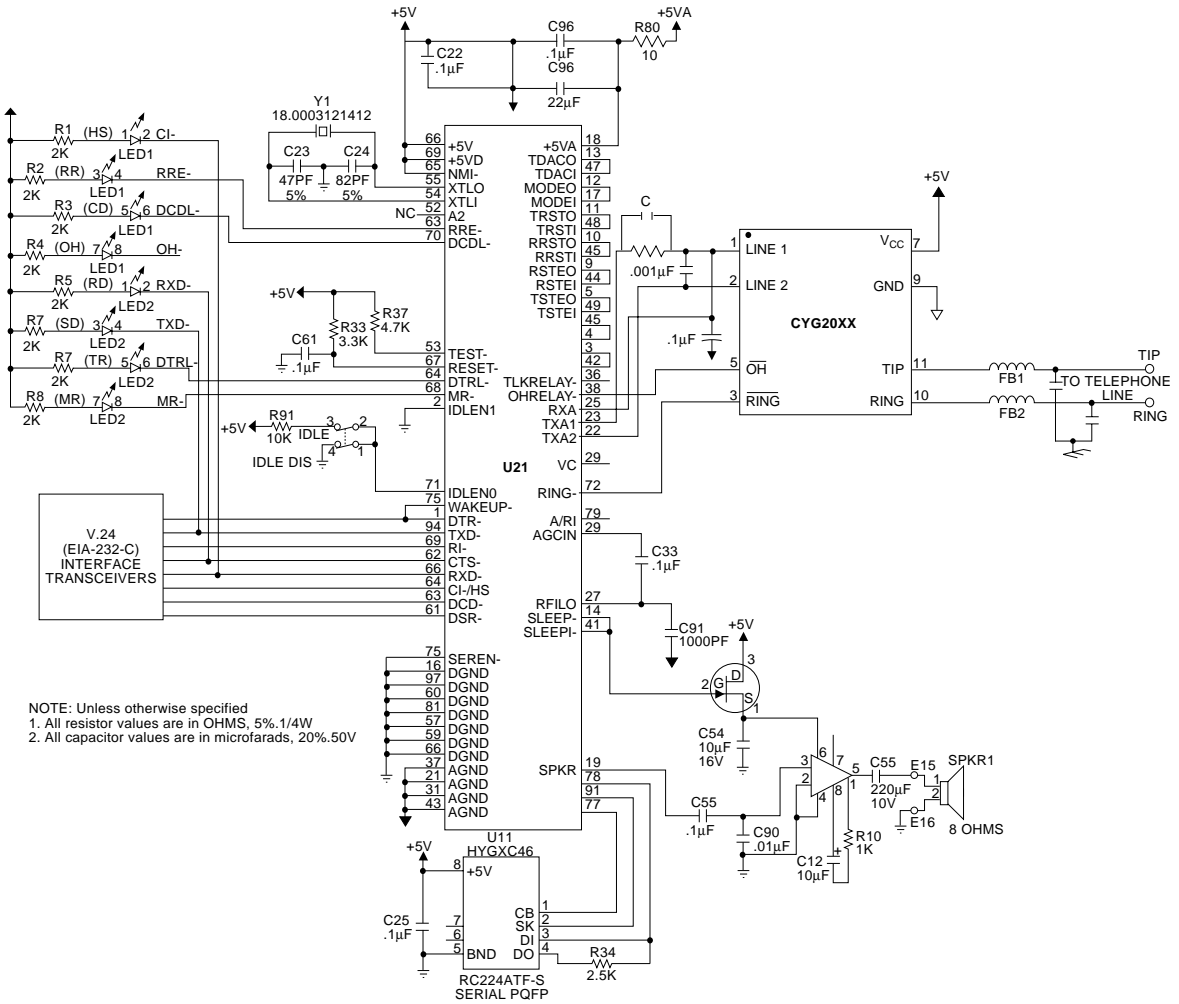

Figure 3. Rockwell 224ATF Fax/Data Modem

Cybergate™ 20XX Series

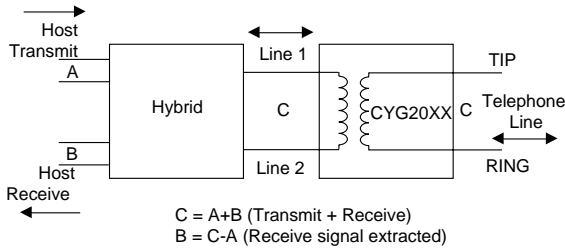

Figure 4. Two-to-Four Wire Hybrid Diagram

Applications Requiring an External 2-4 Wire Hybrid Circuit

For full-duplex communications over the telephone line, it is required that both transmit signals (signals from the host to the telephone line) and receive signals (signals from the telephone line to the host) appear simultaneously on the single pair telephone line. It is the function of the 2-4 wire converter or hybrid to separate the transmit and receive signals from the single pair telephone line and put out the receive signal for the host to process. The hybrid also functions – along with the coupling transformer – to set the proper matching impedance for the telephone line and transmit the host transmit signal to the coupling transformer. It’s important to note that most modems today have this hybrid function built into the chip set (refer to figure 3)

so it won’t be required to design a hybrid circuit in many cases. However, other applications including voice processing circuits may require an “external” hybrid circuit.

Referring to figure 4, the host transmit pair sends a signal denoted as ‘A’ to the telephone line via the Cybergate. Signal ‘C’ on LINE1/LINE2 and TIP/RING represents both the transmit signal from the host ‘A’ and the signal from the telephone line to the host denoted as ‘B’. Signal ‘C’ is the sum $A + B$. The hybrid extracts the receive signal from the telephone line by subtracting the transmit signal from the composite signal appearing at C or $B = C - A$.

The practical implementation of the above scheme varies depending on the particular application; we will examine a very basic hybrid circuit as an example. The hybrid circuit usually consists of a dual operational amplifier and some discrete resistors as shown in figure 5. To simplify the analysis of the circuit, we will explain the operation of:

- Transmit to the telephone line
- Receive from the telephone line
- Receive and transmit signal separation-trans-hybrid loss
- Frequency Response

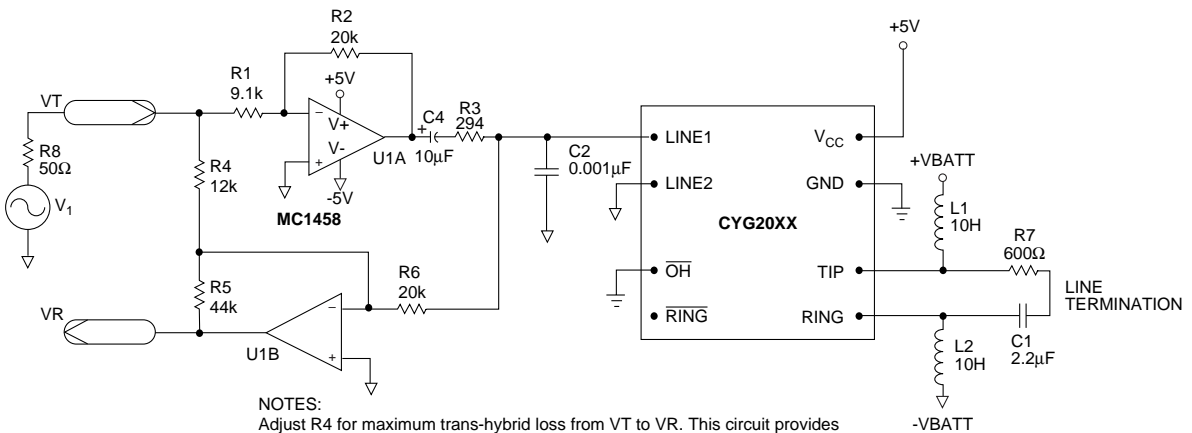

NOTES:
Adjust R4 for maximum trans-hybrid loss from VT to VR. This circuit provides approximately -20dB loss.

R2/R1 provides +7dB amplification to compensate for -7dB transmit insertion loss in circuit.

R5/R6 provides +7dB amplification to compensate for -7dB receive insertion loss in circuit.

R3 at 294Ω provides optimum return loss for nominal 600Ω line termination.

Figure 5. Hybrid Circuit

Cybergate™ 20XX Series

Transmit to the Telephone Line

Suppose that the VT signal from the host system is at a level of -9dBm and we wish to have this signal presented to the telephone line at this level. Since the transmit insertion loss from the data sheet is specified at 7dB, it is necessary to select resistor values R2 and R1 such that U1A will amplify VT by 7dB. Since gain (dB) = 20 Log [R2/R1] we select an arbitrary value of R2 and then calculate R1. For this example we select R2 = 20K which yields an R1 of approximately 9.1K.

Receive from the Telephone Line

In a similar manner to the transmit calculation, we obtain the receive insertion loss from the data sheet and note that it is approximately 7dB. For an overall DAA gain of 1, it is necessary to select resistor values R5 and R6 such that 7dB amplification is achieved. Assuming R6 is 20K, R5 is calculated to be 44K.

Receive and Transmit Signal Separation – Trans-hybrid loss

We now have the transmit and receive gains of U1A and U1B set such that VR will be at the same signal level as the incoming receive signal appearing on the Tip and Ring connections. Also, the Tip and Ring connections will see the same level transmit signal as VT. We must now attenuate the signal transmitted by the host system at VT to keep it from entering the receive path at VR, thus providing receive and transmit separation and completing the 2-4 wire converter. U1B is configured as a summing amplifier that sums the transmit VT signal with the transmit signal appearing at the LINE1 input of the CYG. These signals are 180° out of phase, therefore the resultant output of U1B will be 0V, thus removing the transmit signal from VR. Completely removing VT from VR would represent an infinite trans-hybrid loss. In practical circuits, it is not possible to achieve infinite loss. Losses can range from -10dB to -40dB depending on how well the components are matched and the impedance of the telephone line. Since the telephone line is a complex impedance, trans-hybrid loss also varies over the 300Hz - 4kHz voice band as shown in figure 6. R4 should be optimized to achieve the highest return loss possible with a 600Ω termination as shown in figure 5. R7 and C1 comprise a network suggested by the FCC to emulate the typical telephone line impedance. Telephone line characteristics varies from location to location in actual

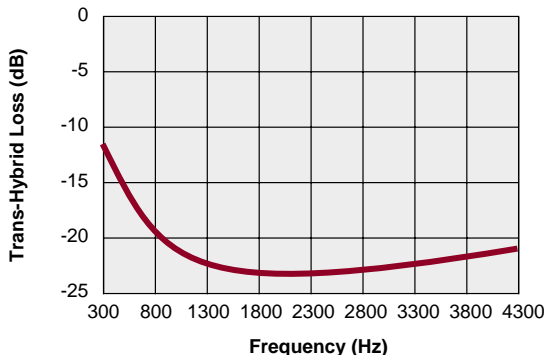

Figure 6. CYG20XX Series Trans-Hybrid Loss

applications, and the 600Ω + 2.2μF combination should serve as a reference. C2 serves to improve the trans-hybrid loss by counteracting the leakage inductance of the transformer at higher frequencies. Referring to figure 6, the return loss maxima occur at the center of the voice band which is desirable for optimum operation.

Precautions When Implementing the Hybrid Circuit

Due to the small size and low distortion characteristics of the CYG20XXs transformer, it is extremely important to use op amps with a low DC output offset voltage. Generally, any DC voltage exceeding 10mV on the output of U1A can cause the transformer's distortion characteristics to degrade due to core saturation. For op amps with higher output offset, it is advisable to use a 10μF capacitor (aluminum or tantalum) in series with R3 as shown in figure 5. This capacitor will block any DC offset voltage thus maintaining the transformer secondary DC current at 0mA. Op amps such as the MC1458 were found not to require this capacitor due to their offset being sufficiently low. The voltage rating of the capacitor should be rated 50VDC.

Return Loss Performance – The return loss is the measure of impedance mismatch of the telephone line and the DAA expressed in dB. Return loss is expressed as:

$$RL(dB) = 20 \text{ Log} \frac{[Z_L + Z_0]}{[Z_L - Z_0]}$$

Z_L = Telephone line impedance in Ω

Z_0 = DAA impedance in Ω

If $Z_L = Z_0$ then the return loss is infinity which is the ideal case. As in the trans-hybrid loss case however, practical return loss figures are much lower than infinity and more like -25dB. Since impedance changes with frequency, the return loss also changes. A graph of return loss vs. frequency for the CYG20XX Series is shown in figure 7. This graph was generated with the CYG20XX terminated by a $600\Omega + 2.16\mu\text{F}$ combination across Tip and Ring connections. Referring to figure 5, the key component determining the return loss match is the 294Ω resistor (R3) feeding the CYG's transformer secondary. This resistor value was selected for optimum return loss when used with the CYG and should not deviate in value by more than 5%.

Frequency Response

The CYG's frequency response is fairly flat with a deviation of ± 0.2 dB. Its frequency response is shown in figure 8.

Regulatory Considerations

Interface to the Public Switched Telephone Network (PSTN)

The Cybergate has been designed to comply with FCC Part 68.3 and DOC CS-03 requirements for connection to the public switched telephone network (PSTN). It is required however, that the designer submit the end product to a test lab to receive certification from the appropriate regulatory agency. The Cybergate requires two external 10Ω 1/8W metal film resistors or one 1/4A fuse to meet the metallic surge requirement referred to in FCC part 68.302(d). This resistor/fuse will open if an 800V surge appears across the telephone line, thus

preventing the Cybergate from asserting a permanent off-hook condition to the telephone line in the event of a lightning strike or other induced surge. The resistor is shown in figure 9.

EMI Considerations (FCC Part 15A/B)

The Cybergate is a fully recognized component for both UL1459 and UL1950. When designing to UL1459, it is necessary to use a 1/4A 250V fuse in either the Tip or Ring line before the connection to the Cybergate™ in order for the recognition to remain valid.

Most commercial equipment are required to meet FCC part 15A or 15B which regulates Electromagnetic Interference (EMI). High speed modems and other circuits that contain high frequency crystal oscillators can present special problems when it comes time to submit the device to the FCC compliance lab. In order to minimize the risks associated with radiated emissions, the designer should keep the following points in mind:

- If possible, use a four-layer PCB design instead of a double-sided PCB. Having a separate V_{CC} and ground plane will minimize radiated emissions and decrease the noise susceptibility of the device. An alternative is to do a double-sided board and four-layer board in parallel and evaluate the results.
- Include a provision on your PCB design for a 1/2 turn ferrite bead and capacitor in your layout from the Tip and Ring terminals of the DAA to the telephone jack as shown in figure 10. This LC network will form a low pass filter that will roll off high frequencies. The decision to populate the

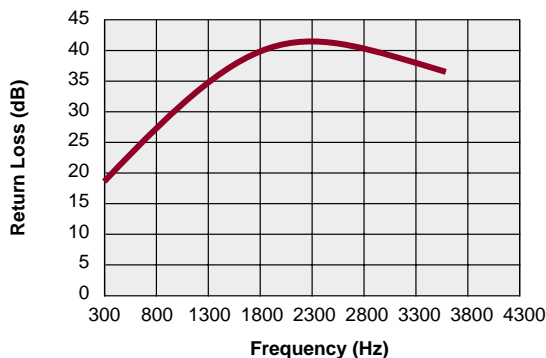

Figure 7. CYG20XX Series Return Loss

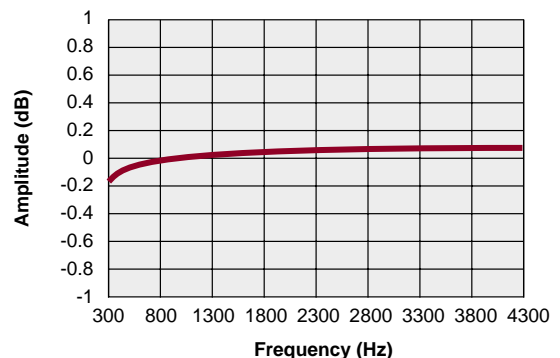

Figure 8.. CYG20XX Series Frequency Response

Cybergate™ 20XX Series

board with these components will be based on the results of the radiated emissions coming out of the telephone line during FCC testing.

- If a multi-layer board is not used, keep ground traces at least 25 mils to 50 mils wide.
- Maintain LINE1 and LINE2 connections as short as possible and use guarding techniques when running these traces.
- Maintain Tip and Ring connections at least 100 mils away from all other connections on the boards. If a ground plane is used, keep the plane away from Tip and Ring connections.

Conclusions

The Cybergate™ 20XX is a complete, functional Data Access Arrangement (DAA), and complements CP Clare's complete line of integrated telecommunication solutions. By incorporating all of our core technologies, such as solid state switching, optical coupling and transformer/coil technology, we are able to provide an unmatched level of functionality and integration for the telecom interface design. Technically, the Cybergate

includes the surge protection, transient protection, ring detection, hookswitch circuitry, and impedance balancing circuits required for the interface design in a compact 1.07" x 1.07" x 0.4" module. In addition to our current offering, ask for versions which include loop current detection and/or Caller ID features. In all, advantages are numerous when utilizing this complete drop-in DAA solution.

Some of the more obvious benefits are as follows:

- Plug and Play DAA
- Compact design for space/PCB cost savings
- Reduced design costs
- Reduced "design to market" time
- Complete integrated solution, including surge protection and transformer
- Very low risk design solution

Coupled with our company's commitment to stand behind the user with "complete applications support", all these benefits make the Cybergate™ 2000/2001 a must when interfacing your product to the Public Switched Telephone Network (PSTN).

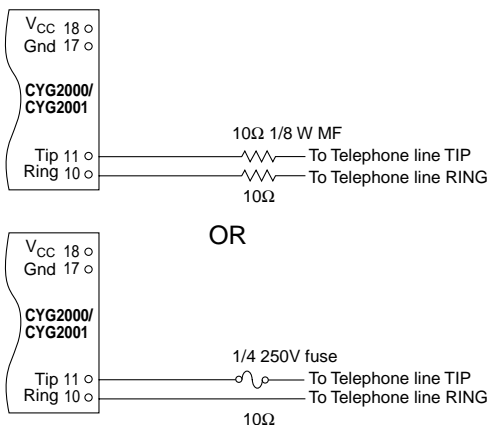

Figure 9. CYG20XX Fuse Requirements

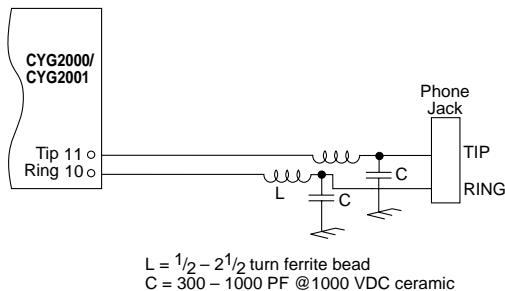
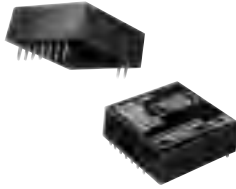

Figure 10. EMI Considerations

Cybergate™ 21XX Series



CP Clare's Cybergate™ 21XX Series Data Access Arrangement (DAA) Module, the CYG2100 (UK, Australia, New Zealand, Finland, Sweden, Norway, Denmark, Holland, Portugal, Italy, Luxembourg, Austria, Belgium) /CYG2110 (France) /CYG2120 (Spain), combines all of the circuitry necessary to implement a complete telephone line interface solution including:

- Low Distortion Signal Coupling (V.34 compatible)
- 1.5kV_{RMS} Isolation
- 300V Surge Protection
- On/Off Hookswitch Relay
- Mute Relay
- Certified to EN60950
- Compatible with EN55022 and EN50082-1
- Full-Wave Ring Detection

Typical applications for the CYG21XX Series include:

- Home Medical Devices
- Plant Monitoring Equipment
- Security/Alarm Systems
- Modems
- Utility Meters
- Voicemail Systems
- Vending Machines
- Elevator Control Boxes
- Network Routers
- PBX Systems
- PC Mother Boards
- Telephony Applications
- Digital Telephone Answering Machines

Description

The CYG21XX Series DAA Module integrates a complete line interface circuit into a compact 1.07" x 1.07" x 0.4" package. The following is a list of major functions included in the DAA, as shown in the functional diagram in figure 1:

- Hookswitch Circuitry
- Ring Detection Circuitry
- Surge Protection
- Gyator Circuitry
- Transformer Coupling
- Mute Function

A brief description for each of these functions follows:

Hookswitch Circuitry – The hookswitch asserts the on-hook and off-hook conditions for the phone interface (the difference between being “on-line” and “off-line”). The hookswitch is activated by the host when the host wishes to place a call or answer a call in response to an incoming ring signal. In order to perform this function in the most effective manner, the CYG21XX Series uses a highly reliable solid state relay activated when the OH pin on the CYG21XX is driven low (logic ‘0’).

The current required at the input to operate the relay is 8mA minimum over temperature range 0 to +70°C. The solid state relay provides no contact “bounce” and provides up to 350V blocking voltage when on-hook.

Ring Detection Circuitry – The ring detection circuitry detects the ring signal from the central office, which indicates the presence of an incoming call. This ring signal is a high voltage AC signal superimposed on the central office DC battery, nominally 48VDC. This AC signal can be at any frequency between 15 – 60Hz and

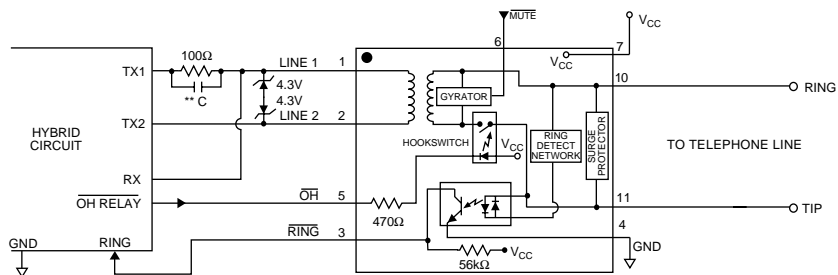

Figure 1. Functional Block Diagram

Cybergate™ 21XX Series

have an RMS voltage between 25 and 120 volts, with a typical ring cadence of 2 seconds on and 4 seconds off. The ring detection network includes an LED that emits light on one half cycle of the ring frequency and couples this light to an output phototransistor. The output phototransistor provides pulses from +V_{CC} (via an internal 56K pull-up resistor) to ground, in response to the ring signal. These pulses are presented to the RING pin on the CYG21XX Series. The duty cycle of these pulses is dependent on the amplitude and frequency of the incoming ring signal. The RING signal is typically connected to an input port on the microcontroller or data pump located on the host system, where it is qualified as a valid ring signal.

Surge Protection Circuit – Metallic (Tip to Ring) surge protection is another key feature included in the CYG21XX Series. All circuits function per specification under normal conditions.

Gyrator Circuitry – The gyrator circuit included in the Cybergate™ provides a low DC resistance and a high AC impedance to the telephone line when the CYG21XX Series is in the off-hook state. By doing this, the gyrator is approximating the operation of an inductor (a space saving feature as opposed to using a discrete inductor). The electronic inductor circuitry is required so that the DC current from the telephone line is diverted away from the transformer windings, thus providing the high linearity necessary for V.34 modem performance.

Transformer Coupling – A low distortion transformer is used to couple voice/data/fax signals to and from the CYG21XX Series. The transformer provides the galvanic isolation of 1500V_{RMS} required to meet the supplementary level of isolation of EN60950/EN41003.

Mute Function – The Mute function provides a low impedance for pulse dial. During pulse dialing, the MUTE control is activated on or slightly before (no more than 50 ms) the start of the first dial pulse. It is then kept active until or just after the end of the last pulse of the dial string (no more than 50 ms again).

Power Consumption

The CYG21XX Series consumes very little power from the host system. This power is mainly limited to the hookswitch relay which consumes about 40mW with a +V_{CC} of 5V and corresponding LED current of 8mA. +V_{CC} can be greater than +5V if desired as there is an internal 470Ω LED current limiting resistor in the CYG21XX Series.

It is important to note that +V_{CC} should be no higher than 20V. This is because the ring detect output transistor's collector is pulled to +V_{CC} via a 56K resistor. The maximum V_{CEO} of the transistor is 20V and should therefore not be exceeded.

The CYG21XX Series is designed to dissipate about 1.5W of power from the telephone line at a maximum ambient temperature of 70°C.

Interfacing the CYG21XX Series to a Modem Chip

Figure 3 shows a CYG21XX Series connected to a Rockwell 224ATF Fax/Data modem. The 224ATF has an internal 2-4 wire hybrid that eliminates the need for an external hybrid circuit. The modem circuit shown is a 2400 bps data modem with 9600 bps fax capability. The TXA1 and TXA2 pins from the 224ATF represent the differentially driven transmit signal and the RXA is the single-ended signal from the telephone line to the modem. The required matching network consists of a resistor with a parallel capacitor. The capacitor will be a 10% ceramic, 16V device and the resistor will be 2%, 1/8W in the range 100Ω – 900Ω depending on the country.

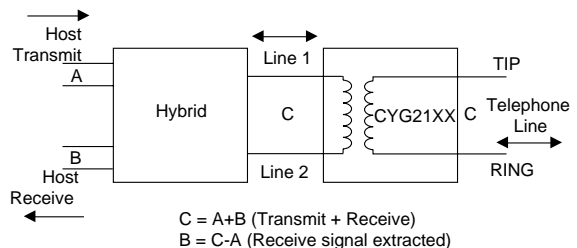

Figure 2. Two-to-Four Wire Hybrid Diagram

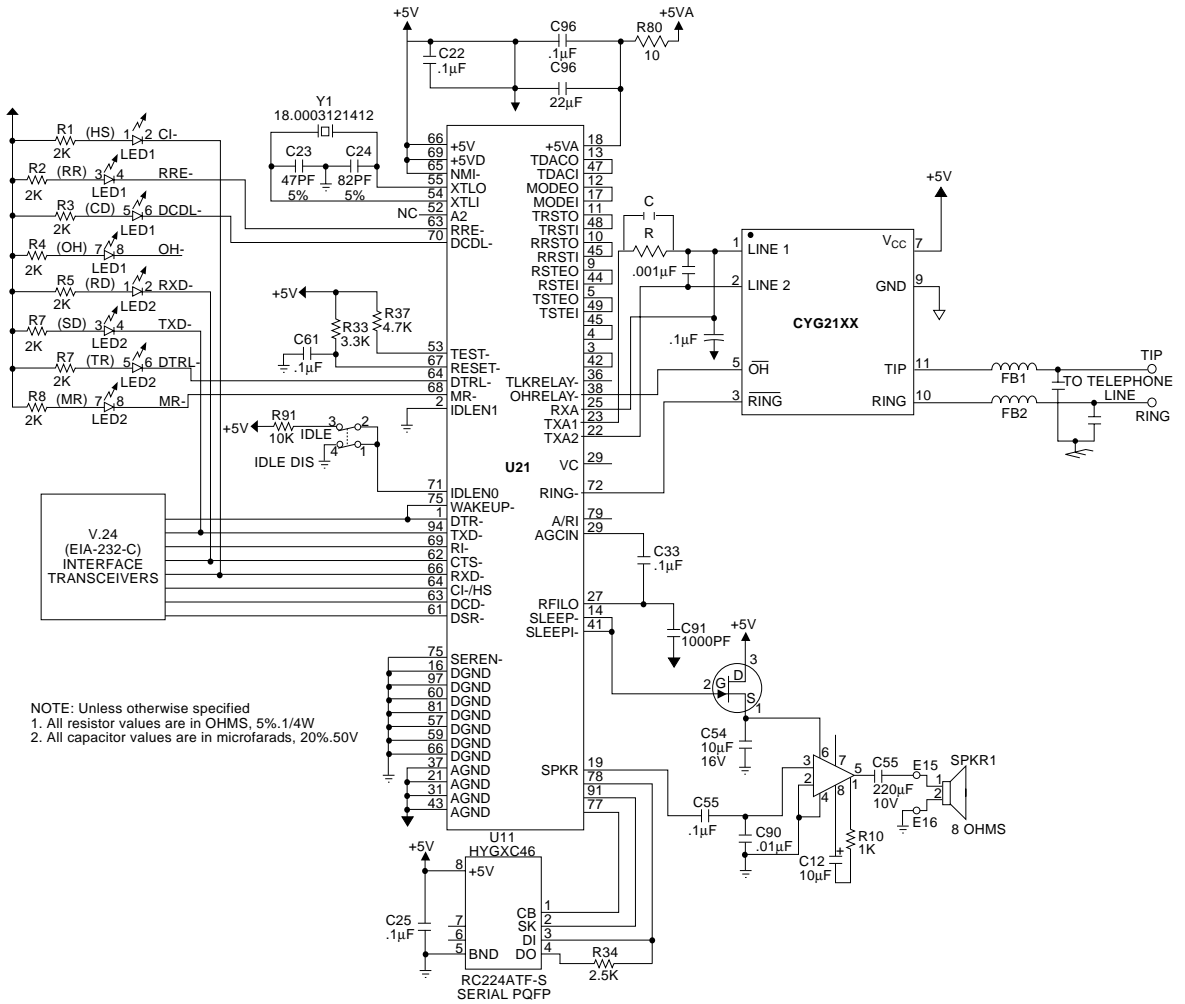

Figure 3. Rockwell 224ATF Fax/Data Modem

Cybergate™ 21XX Series

Applications Requiring an External 2-4 Wire Hybrid Circuit

For full-duplex communications over the telephone line, it is required that both transmit signals (signals from the host to the telephone line) and receive signals (signals from the telephone line to the host) appear simultaneously on the single pair telephone line. It is the function of the 2-4 wire converter or hybrid to separate the transmit and receive signals from the single pair telephone line and put out the receive signal for the host to process. The hybrid also functions – along with the coupling transformer – to set the proper matching impedance for the telephone line and transmit the host transmit signal to the coupling transformer. It's important to note that most modems today have this hybrid function built into the chip set (refer to figure 3) so it won't be required to design a hybrid circuit in many cases. However, other applications including voice processing circuits may require an "external" hybrid circuit.

Referring to figure 2, the host transmit pair sends a signal denoted as 'A' to the telephone line via the CYG21XX Series. Signal 'C' on LINE1/LINE2 and TIP/RING represents both the transmit signal from the host 'A' and the signal from the telephone line to the host denoted as 'B'. Signal 'C' is the sum $A + B$. The hybrid

extracts the receive signal from the telephone line by subtracting the transmit signal from the composite signal appearing at C or $B = C - A$.

The practical implementation of the above scheme varies depending on the particular application, however, we will examine a very basic hybrid circuit as an example. The hybrid circuit usually consists of a dual operational amplifier and some discrete resistors as shown in figure 4. To simplify the analysis of the circuit, we will explain the operation of:

- Transmit to the telephone line
- Receive from the telephone line
- Cancellation of the host transmit signal VT from the receive path VR

Transmit to the Telephone Line

Suppose that the VT signal from the host system is at a level of -9dBm and we wish to have this signal presented to the telephone line at this level. Since the transmit insertion loss from the data sheet is specified at 7dB, it is necessary to select resistor values R2 and R1 such that U1A will amplify VT by 7dB. Since $\text{gain (dB)} = 20 \text{ Log } [R2/R1]$ we select an arbitrary value of R2 and then calculate R1. For this example we select $R2 = 20K$ which yields an R1 of approximately 9.1K.

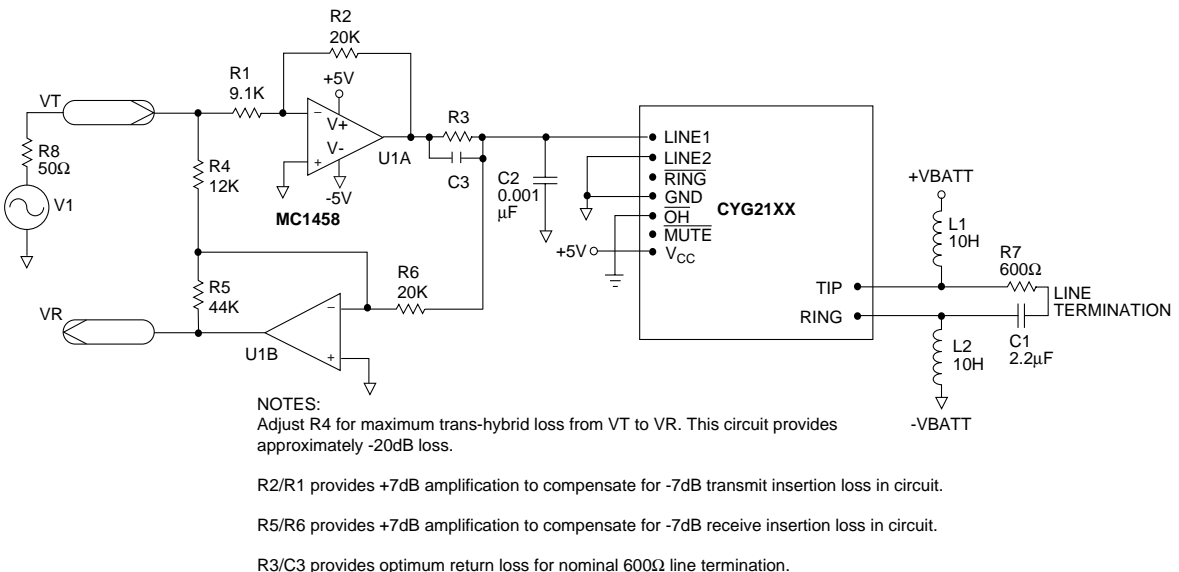

Figure 4. Hybrid Circuit

Receive from the Telephone Line

In a similar manner to the transmit calculation, we obtain the receive insertion loss from the performance specifications and note that it is approximately 7dB. For an overall DAA gain of 1, it is necessary to select resistor values R5 and R6 such that 7dB amplification is achieved. Assuming R6 is 20K, R5 is calculated to be 44K.

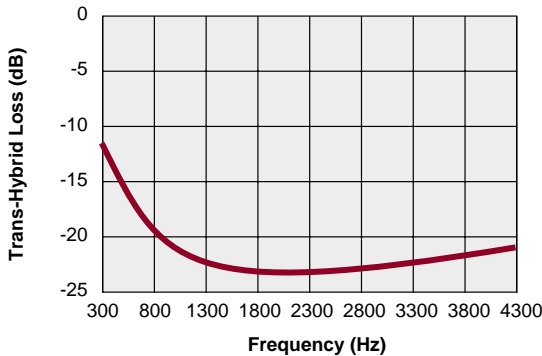

Figure 5. CYG21XX Series Trans-Hybrid Loss

Receive and Transmit Signal Separation – Trans-hybrid loss

We now have the transmit and receive gains of U1A and U1B set such that VR will be at the same signal level as the incoming receive signal appearing on the

Tip and Ring connections. Also, the Tip and Ring connections will see the same level transmit signal as VT. We must now attenuate the signal transmitted by the host system at VT to keep it from entering the receive path at VR, thus providing receive and transmit separation and completing the 2-4 wire converter. U1B is configured as a summing amplifier that sums the transmit VT signal with the transmit signal appearing at the LINE1 input of the CYG21XX Series. These signals are 180° out of phase, therefore the resultant output of U1B will be 0V, thus removing the transmit signal from VR. Completely removing VT from VR would represent an infinite trans-hybrid loss. In practical circuits, it is not possible to achieve infinite loss. Losses can range from -10dB to -40dB depending on how well the components are matched and the impedance of the telephone line. Since the telephone line is a complex impedance, trans-hybrid loss also varies over the 300Hz - 4kHz voice band as shown in figure 5. R4 should be optimized to achieve the highest trans-hybrid loss possible with termination as shown in figure 6. R7 and C1 comprise a network to emulate the typical telephone line impedance.

Telephone line character varies from location to location in actual applications. Referring to figure 7, the return loss maxima occur at the center of the voice band which is desirable for optimum operation.

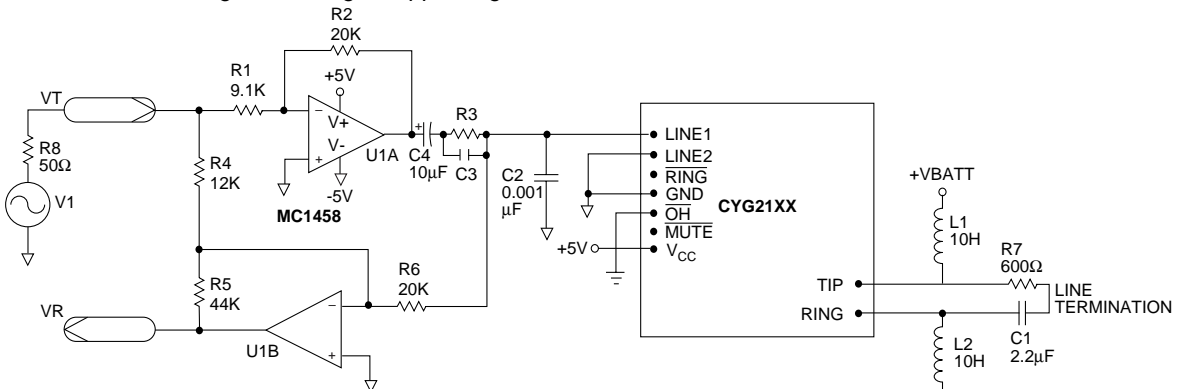

NOTES:
Adjust R4 for maximum trans-hybrid loss from VT to VR. This circuit provides approximately -20dB loss.

R2/R1 provides +7dB amplification to compensate for -7dB transmit insertion loss in circuit.

R5/R6 provides +7dB amplification to compensate for -7dB receive insertion loss in circuit.

R3/C3 provides optimum return loss for nominal 600Ω line termination.

Figure 6. CYG21XX Series Hybrid Circuit with DC Blocking Capacitor (C4)

Cybergate™ 21XX Series

Precautions When Implementing the Hybrid Circuit

Due to the small size and low distortion characteristics of the CYG's transformer, it is extremely important to use op amps with a low DC output offset voltage. Generally, any DC voltage exceeding 10mV on the output of U1A can cause the transformer's distortion characteristics to degrade due to core saturation. For op amps with higher output offset, it is advisable to use a 10µF capacitor (aluminum or tantalum) in series with R3 as shown in figure 6. This capacitor will block any DC offset voltage thus maintaining the transformer secondary DC current at 0mA. Op amps such as the MC1458 were found not to require this capacitor due to their offset being sufficiently low. The voltage rating of the capacitor should be rated 50VDC.

Return Loss Performance

The return loss is the measure of impedance mismatch of the telephone line and the DAA expressed in dB. Return loss is expressed as:

$$RL(dB) = 20 \text{ Log} \frac{[Z_L + Z_0]}{[Z_L - Z_0]}$$

Z_L = Telephone line impedance in Ω

Z_0 = DAA impedance in Ω

If $Z_L = Z_0$ then the return loss is infinity which is the ideal case. As in the trans-hybrid loss case however, practical return loss figures are much lower than infinity and more like -25dB. Since impedance changes with frequency, the return loss also changes. A graph of return loss vs. frequency for the CYG21XX Series is shown in figure 7. This graph was generated with the CYG21XX Series terminated by a 600 Ω + 2.16µF combination across Tip and Ring connections. Referring to figure 6, the key component determining the return loss match is the resistor (R3) and capacitor (C3) feeding the Cybergate™ transformer secondary. This resistor value was selected for optimum return loss when used with the CYG21XX Series and should not deviate in value by more than 5%. The value of R3 can vary from 100 Ω up to 900 Ω depending on the country.

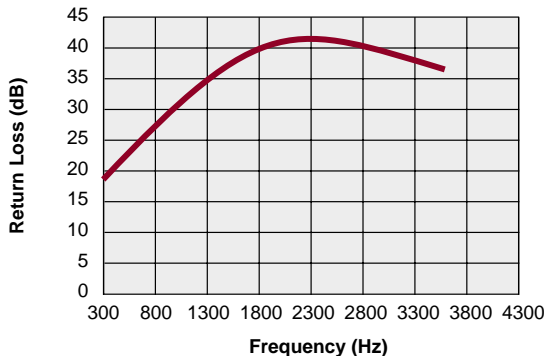

Figure 7. CYG21XX Series Return Loss

Frequency Response

The CYG's frequency response is fairly flat with a deviation of ± 0.2 dB. Its frequency response is shown in figure 8.

Regulatory Considerations

Interface to the Public Switched Telephone Network (PSTN)

The CYG21XX Series has been designed to comply with PTT clauses relevant to DAA specifications from the following standards:

Country	Relevant Specification
UK	NV NTR
Australia	TS002
New Zealand	PTC102, PTC211
Finland	ETS 300 001/SP-Method 1732
Sweden	SS-ETS 300-001 T3
Norway	GFA/SP-AR 1990:61
Denmark	ETS 300-001 NET4
Holland	T10-00, T11 Series
Portugal	ICP 25.01.51.001
Spain (CYG2120)	UNE-ETS 133 001 (Parts 1 & 2)
Italy	ETS 300-001 NET4
Luxembourg	Holland Specs
Austria	FTV221,FTV201,FTV310
Belgium	BE/SP-201 (NET4)
France (CYG2110)	B1123A

It is required however, that the designer submit the end product to a test lab to receive certification from the appropriate regulatory agency.

Cybergate™ 21XX Series

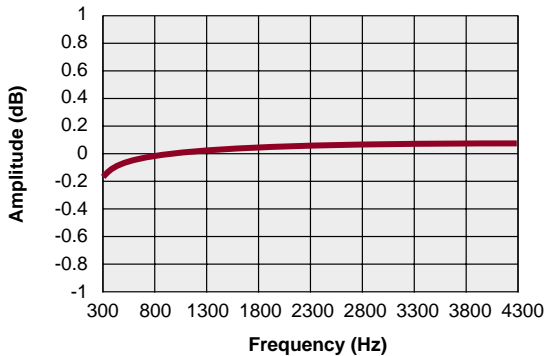

Figure 8. CYG21XX Series Frequency Response

EMI Considerations

The CYG21XX Series is designed to meet both EN55022 and EN50082-1 requirements.

High speed modems and other circuits that contain high frequency crystal oscillators can present special problems when it comes time to submit the device to the compliance lab. In order to minimize the risks associated with radiated emissions, the designer should keep the following points in mind:

- If possible, use a four-layer PCB design instead of a double-sided PCB. Having a separate VCC and ground plane will minimize radiated emissions and decrease the noise susceptibility of the device. An alternative is to do a double-sided board and four-layer board in parallel and evaluate the results.
- Include a provision on your PCB design for a 1/2 turn ferrite bead and capacitor in your layout from the Tip and Ring terminals of the DAA to the telephone jack as shown in figure 9. This LC network will form a low pass filter that will roll off high frequencies. The decision to populate the board with these components will be based on the results of the radiated emissions coming out of the telephone line during EMI testing.
- If a multi-layer board is not used, keep ground traces at least 25 mils to 50 mils wide.
- Maintain LINE1 and LINE2 connections as short as possible and use guarding techniques when running these traces.

- Maintain Tip and Ring connections at least 100 mils away from all other connections on the boards. If a ground plane is used, keep the plane away from Tip and Ring connections.

Conclusions

The Cybergate™ 21XX Series is a complete, functional Data Access Arrangement (DAA), and complements CP Clare's complete line of integrated telecommunication solutions. By incorporating all of our core technologies, such as solid state switching, optical coupling and transformer/coil technology, we are able to provide an unmatched level of functionality and integration for the telecom interface design. Technically, the CYG21XX Series includes the surge protection, ring detection, mute function, hookswitch circuitry, and impedance balancing circuits required for the interface design in a compact 1.07" x 1.07" x 0.4" module. In all, advantages are numerous when utilizing this complete drop-in DAA solution.

Some of the more obvious benefits are as follows:

- Plug and Play DAA
- Compact design for space/PCB cost savings
- Reduced design costs
- Reduced "design to market" time
- Complete integrated solution, including surge protection and transformer
- Very low risk design solution

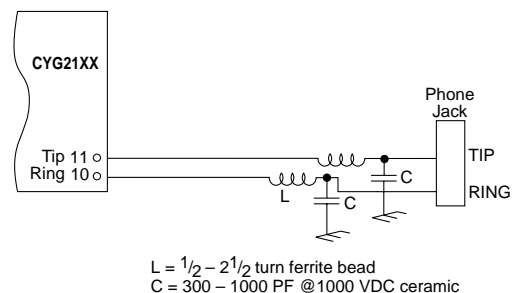

Figure 9. EMI Considerations

Reliability

Electrostatic Discharge (ESD)

CP Clare devices are electrostatic discharge (ESD) sensitive and it is necessary to take specific precautions in order to ensure protection from damage that may be induced by ESD. We follow all precautions identified in EIA 541 (Packaging ESD devices) and EIA 625 (ESD Handling) and perform an internal audit in order to ensure our conformance to ESD guidelines. Our product is measured for ESD sensitivity on a quarterly basis, during which we measure the threshold of existing product to ensure that ESD protection levels are being met.

CP Clare measures the ESD sensitivity by employing three models:

- 1) Human Body Model (HBM)
This type of ESD simulation test is associated with people who acquire a charge from everyday movement and a discharge from the person's finger to the component. The HBM simulation is performed according to ESD-S5.1 1993.
- 2) Charged Device Model (CDM)
Charged device simulation test is associated with a discharge occurring when a component approaches an electrical conductor with a different electrostatic potential. The CDM simulation is performed according to ESD-DS5.3 1993.
- 3) Machine Model (MM)
The machine model simulation test is associated with the charge build-up between the machine and the component, and then discharged upon contact. This simulation provides no resistance in order to replicate a conductive machine. The MM simulation is performed according to ESD-S5.2 1994.

The results of the ESD testing are listed in Table 1.

Reliability Testing

CP Clare employs the techniques of reliability testing in order to continuously monitor and evaluate the quality performance and conformance of our standard product. The reliability of our product is measured along three key points of product life:

- Dead on arrival as measured in PPM per EIA-STD SSA

Part Type	HBM ESD Threshold Voltage (kV)	MM ESD Threshold Voltage (kV)	CDM ESD Threshold Voltage (kV)
LCA110	>8.0	>2.0	>1.5
LCA110L	>8.0	>2.0	>1.5
LCA120	>14.0	>3.0	>4.0
LCA700	>8.0	>2.0	>1.5
OMA130	>8.0	>2.0	>1.5
OMA160	>8.0	>2.0	>1.5
PLA140	7	1.2	1.1
PLA150	>8.0	>2.0	1.3
LCB110	>8.0	>2.0	>1.5
LCB120	>8.0	>2.0	>1.5
TS117L(LEDs)	>8.0	>2.0	>1.5
PAA110	1.5	0.6	0.85
PAA110L	1.5	0.45	0.75
OAA160	>8.0	>2.0	>1.5
PAA140	3.5	1.3	1.35
LBA110	>8.0	>2.0	>1.5
LBA126	>8.0	0.65	>1.5
LBA127	>8.0	>2.0	>1.5
LDA101	6.5	0.85	>1.5
LDA201	6	0.85	>1.5
LDA111	>8.0	>2.0	>1.5
FDA200	<0.5	<0.05	<0.35
FDA215	<0.5	0.1	0.5

Table 1

- Infant Mortality (IM) in percent (%)
- Steady State (SS) as measured in FITs

The product improvement programs that we have in progress are focused on continually improving device reliability and adherence to operating specifications.

- The (PPM) level of our product is measured at an internal Quality Audit prior to shipment. All defects detected at the audit are included in the calculation of PPM-5, per EIA-STD 554.
- Infant mortality is determined by a 48 hour HTRB testing performed weekly on our standard product.
- Steady state failure rates are determined through our monthly Reliability Monitors and quarterly Requalifications of our product.

The tests used for calculation of PPM, IM and SS are listed in Table 2:

	Test	Conditions	Duration	SS
PPM	Electrical	Data Sheet @ 25°C	N/A	6 Month Rolling
IM	HTRB	110°C, 80% WVDC	48 hours	250
	Ir Reflow	150 to 215°C C-Scan and/or cross section	2 passes	77
SS	Solderability	245°C	2 sec.	32
	HAST	120°C, 85% RH, 80% WVDC	100 hrs	77
	HTRB	125°C, 80% WVDC	1000 hrs	129
	Autoclave	121°C, 100% RH	96 hrs	52
	Hot Storage	125°C	1000 hrs	52
	Cold Storage	-40°C	1000 hrs	52
	Thermal Shock Thermal Cycle	0 to 100°C -55 to +125°C	15 cycles 100 cycles	55
HIPOT	3000 V _{rms} and 3750 V _{rms}	60s, then to failure	10	

Table 2

Thermal Impedance

The thermal impedance of CP Clare MOSFET based product is measured per JEDEC standard 24-3. The testing simulates the component in still air:

Characteristic	Value	Units of Measure
Air velocity	0.0	LF/Minute
Theta JA	159.94	°C/Watt
Theta JC	75.11	°C/Watt

Plastic Package Information

All CP Clare components are packaged in epoxy resin exhibiting the following characteristics:

Flammability	UL 94 V-O
Total Ionics	1.02 MicroMhos/cm
Moisture Uptake	0.28 % by wt
Filler (silica)	70 % by wt
CTE	19 PPM/°C
Tg	160°C

Reliability

Soldering

The soldering conditions for CP Clare components will vary depending on the package style:

1. Through hole components:
When soldering through hole components, the soldering temperature must be kept at 260°C maximum for a duration of 10 seconds or less.
2. DIP, Flatpack, and SOIC surface mount components:

Infrared reflow (IR) soldering;

Ramp-up rate	2°C/sec.	Max
Dwell time at 125°C	120 sec.	Max
Dwell time at 180°C	120 to 180 sec.	Max
Maximum temp.	220 +5/-0°C	N/A
Dwell time at max. temp.	10 to 40 sec.	N/A
Ramp-down rate	-6°C/sec.	Max

Vapor phase reflow;

Dwell time at 215 to 219°C	60 sec.	Max
----------------------------	---------	-----

CP Clare has characterized the moisture/reflow sensitivity of surface mount components using

procedures JESD 22-A112 and JESD22-A113. Moisture uptake from atmospheric humidity occurs by diffusion. During the solder reflow process, in which the component is attached to a printed circuit board, the whole body of the component is exposed to the process temperatures. The combination of moisture uptake and reflow soldering may lead to moisture induced delamination and cracking of the component. Using the IR profile and test procedures given above, CP Clare surface mount components are level 1, not moisture sensitive. The moisture sensitivity of surface mount components are measured once each quarter to ensure there is no change in moisture sensitivity levels.

Moisture classifications are based on a maximum package (i.e. case temperature measured at the top center of the component) temperature of 220 +5/ -0°C. If temperatures greater than this are used, the moisture classification will not be valid. At higher temperatures, a re-evaluation of the component's moisture sensitivity will be required. CP Clare will work with the component user to define the best processing for temperatures above 220 +5/ -0°C and ramp rates greater than 2°C / second. Also, CP Clare components are smaller than other IC's that may populate the printed circuit board, and hence will be exposed to higher temperatures. The component user should account for this when determining the maximum temperature of IR reflow.

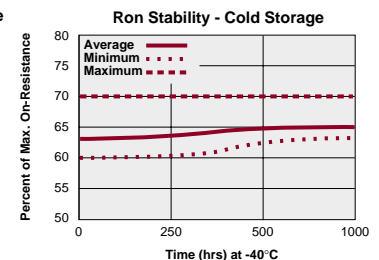
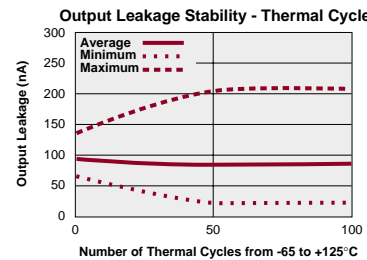
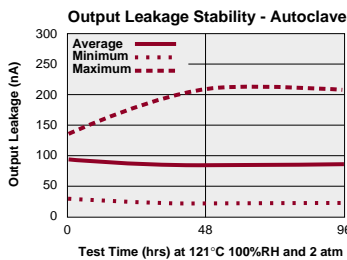
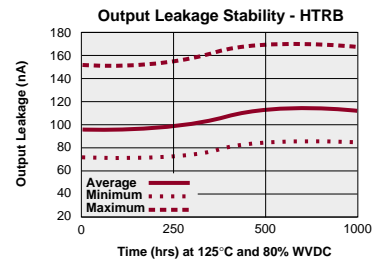
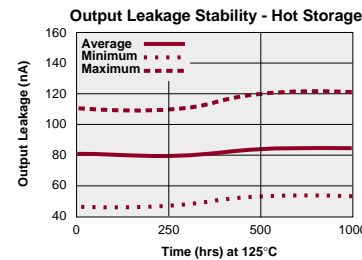
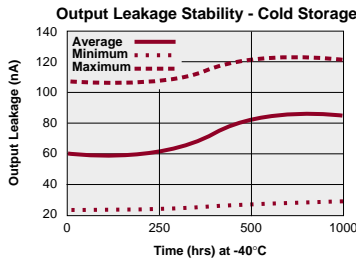
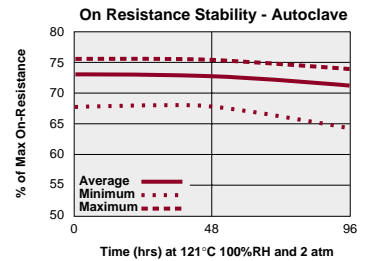
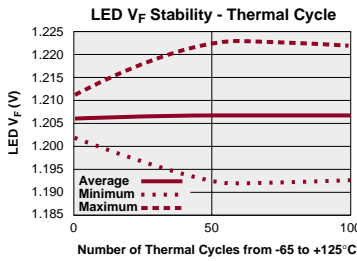
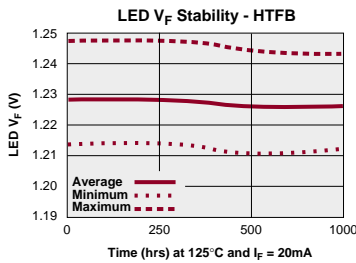
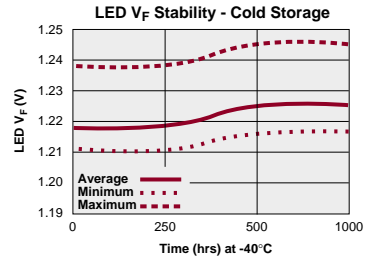
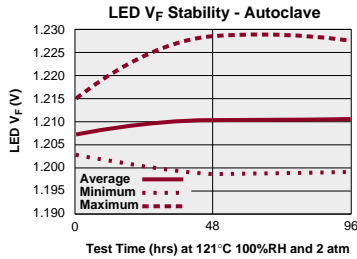
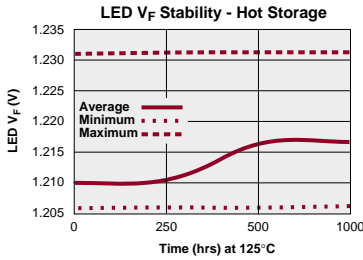

Reliability

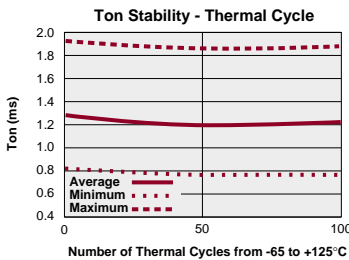
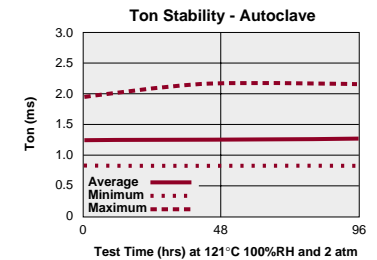
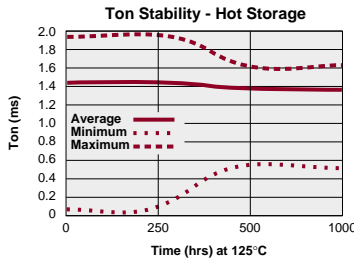
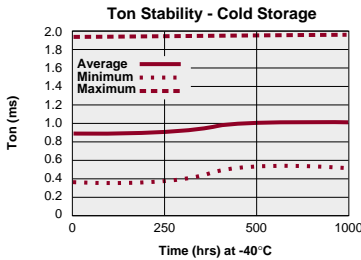
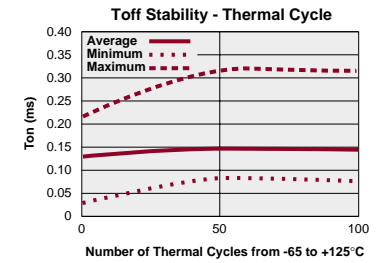
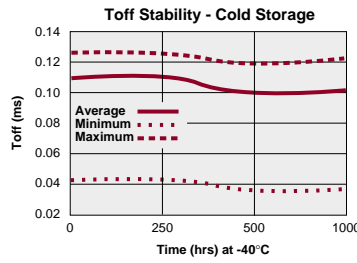
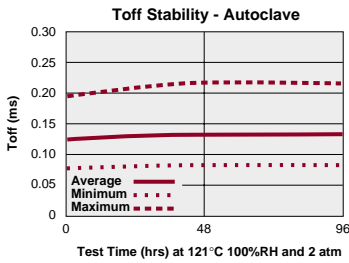
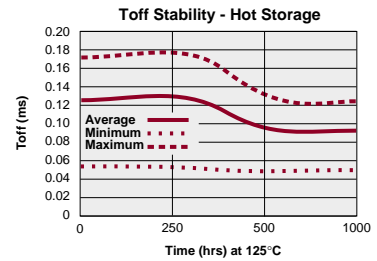
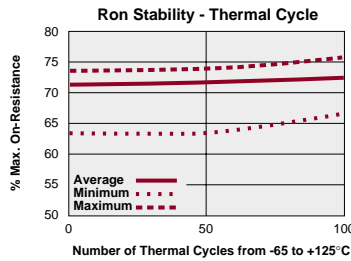
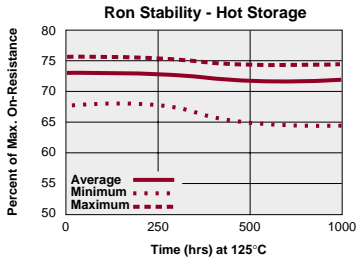

CP Clare's Reed Relay Products are manufactured to cover the global requirements for dry reed switches, and relays. CP Clare's Reed Relays are designed in modular packages so custom relay requirements can be readily incorporated. Please call our applications engineering group to discuss these special requirements.

Reed Relays continue to develop and expand as a technology due to the improvement of the following: contacts from a plated surface to a sputtered surface;

the process technology and design for manufacturing; reed relays meeting survivability requirements after being subjected to immersion in vapor phase, IR reflow or convection ovens in a surface mounting solder reflow environment; the ability of reed relays to contain leakage rates in the low femto amps; with the package sizes decreasing dramatically; the reed relays showing excellent RF as well as time domain (fast pulse) characteristics. The reed relay will be around well into the 21st century. Some of the features and the markets where reed relays are used are listed below.

Reed Relay Features:

- High Insulation Resistance (up to $10^{15}\Omega$)
- Low & Stable Contact Resistance
- High Isolation Input to Output (up to 20KV)
- High Switching Speeds (up to 1KHz)
- Auto Insertable & Low Profile Capability
- Surface Mounting Capability
- Wave Solderable & Washable Capability
- Low Input Power Capability (<50mW)
- Low Capacitance
- Switching of RF Signals >1 GHz
- Hermetically Sealed
- Agency Approvals (UL, CSA, BABT, etc.)

Market Segments and application areas where our reed relays are used:

- Telecom
 - Modem Switching
 - Current Sensing
 - Test Equipment
 - Line Switching
 - Cellular and Portable Phones
- ATE
 - Board Testers
 - VLSI Testers
 - Cable Testers
 - Automotive Diagnostics Systems
- Instrumentation
 - Data Acquisition
 - Scanners
 - Multiplexers
 - Multimeters
 - Medical Equipment
- Security
 - Passive Infrared Detectors
 - Ultrasonic Detectors
 - Smoke/Fire Alarms

Electromechanical Relays

Electromechanical Relays (EMRs) are similar to reed relays in that they are magnetically actuated by a relay coil or solenoid and actual metal contacts close and initiate a circuit. EMRs are plastic sealed unlike reed relays which are hermetically sealed. EMRs by design are multi-functional and typically are 2-Form-C (double pole double throw). If multi-pole form C switching and 'hot' switching are required, EMRs are the design of choice. If switching low level signals < 5 volts and < 10 mA reed relays are a better choice. EMRs by design have a stronger restoring force with heavier contacts, and therefore, have the ability to switch voltages and currents into the millions of operations. When switching higher voltages and currents for 10s of

millions of operations high power high performance reed relays become the design-in choice. EMR's small size is particularly inviting when constructing a matrix requiring 'hot' switching.

Our EMRs are made on an automated line optimizing quality and providing the lowest possible cost. For this reason we do not have many options available and do not offer many specials.

The EMRs are capable of switching up to 125 VA and can switch up to 2 amp max with a max switching voltage of 250 volts. Voltage standoff between coil and contact can be as high as 2500 volts.

Electromechanical Features:

- High Power Switching (up to 1KHz)
- 2-Form-C (double pole double throw) contacts
- Long Life (Millions of Operations at Load)
- Low Contact Resistance
- High Carry Current
- Wave Solderable & Washable Capability
- Auto Insertable Capability
- Small Size
- Pin Out Standardization

Market Segments and Application areas where EMRs are used:

- Telecom
 - Modem Switching
 - Test Equipment
 - Line Switching
- ATE
 - Board Testers
 - VLSI Testers
 - Cable Testers
 - Automotive Diagnostics Systems
- Instrumentation
 - Data Acquisition
 - Scanners
 - Multiplexers
 - Multimeters
- Security
 - Passive Infrared Detectors
 - Ultrasonic Detectors
 - Smoke/Fire Alarms



DESCRIPTION

The 1" x 0.1" grid relay series is a general purpose series that is pin-for-pin compatible with most competitor relays. Some configurations of this relay series are capable of switching up to 1000 Volts and up to 2 Amps with a maximum 50 Watt switching. The series includes Form-A, Form-B and Form-C models, some of which have up to 6 poles.

FEATURES

- Standard nominal voltages include 5, 12 and 24 volts
- Electromagnetic shield
- Multi-pole configurations
- 1.0" x 0.15" pin spacing available
- FCC Part 68 compatible

APPLICATIONS

- Telecom
- Instrumentation
- General purpose electronics
- Industrial
- Process control

APPROVALS

- UL Recognized (MRB)

RATINGS (@ 25° C)

Parameter	Min	Typ	Max	Unit
Switching Voltage				
MRB			200	Volts
922A			125	Volts
Switching Current				
MRB			0.50	Amps
922A			0.25	Amps
Carry Current				
MRB			1.5	Amps
922A			0.4	Amps
Switching Frequency				
MRB/922A			500	Hz
Contact Resistance				
MRB/922A			200	mΩ

(See detailed specifications for more information.)

1" x 0.1" GRID RELAYS

MRB ■ 922A

SPECIFICATIONS

All parameters are at 25°C unless otherwise stated.

Operate voltage, release voltage, and coil resistance will change approximately 0.4%/°C as ambient temperature varies.

PARAMETER	CONDITIONS	SYMBOL	MRB			922A			UNITS
			MIN	TYP	MAX	MIN	TYP	MAX	
Contact Ratings									
Switching Voltage	Max DC/PeakAC Resistive	V _L	-	-	200	-	-	125	Volts
Switching Current	Max DC/PeakAC Resistive	I _L	-	-	0.5	-	-	0.25	Amps
Carry Current	Max DC/PeakAC Resistive	I _c	-	-	1.5	-	-	0.4	Amps
Contact Rating	Max DC/PeakAC Resistive	-	-	-	10	-	-	3	Watts
Life Expectancy	Signal Level 1.0V 10mA Rated Loads ⁽¹⁾	-	300	500	-	-	100	-	x10 ⁶ Ops x10 ⁶ Ops
Static Contact Resistance	50mV, 10mA	CR	-	-	200	-	-	200	mΩ
Dynamic Contact Resistance	.5V, 50mA at 100Hz, 1.5 msec	DCR	-	-	200	-	-	200	mΩ
Contact Material		-	-	Rh	-	-	Ru	-	-
Hg Content		-	-	N/A	-	-	N/A	-	mgrams
Relay Specifications									
Insulation Resistance	Between all isolated pins at 100V, 25°C, 40% RH	IR	10 ¹⁰	-	-	10 ⁸	-	-	Ω
Capacitance		-	-	-	1	-	-	-	pF
Across Open Contacts		-	-	-	2	-	-	-	pF
Open Contact to Coil		-	250	-	-	-	-	-	VDC/PeakAC
Dielectric Strength	Between Contacts Contacts to Coil	I/O	1400	-	-	-	-	-	VDC/PeakAC
Operate Time including bounce	At Nominal Coil Voltage 10Hz Square Wave	T _{OP}	-	1	2	-	1.5	-	ms
Release Time	Zener-Diode Suppression	T _{REL}	-	0.50	2	-	2	-	ms
Environmental Ratings									
Storage Temperature		T _A	-40	-	+105	-40	-	+105	°C
Operating Temperature		T _O	-20	-	+85	-38	-	+85	°C
Soldering Temperature	Applied to pins, 5 sec. max.	-	-	-	+260	-	-	+260	°C
Vibration Resistance (Survival)	10Hz - 500Hz	G	-	-	10	-	-	10	Gs
Shock Resistance (Survival)	11±1ms, 1/2 Sine Wave	S	-	-	20	-	-	30	Gs
Weight		-	-	5.8	-	-	-	5.1	grams

⁽¹⁾ For further information, consult factory

COIL SPECIFICATIONS

	Coil Voltage			Coil Resistance			Operate Voltage			Release Voltage			Nominal Input Power		
Units	Volts			Ω			Volts			Volts			mW		
Conditions				±10% (25°C)			Must operate by (25°C)			Must release by (25°C)					
Part #	Min	Typ	Max	Min	Typ	Max	Min	Typ	Max	Min	Typ	Max	Min	Typ	Max
MRB1A05		5	13	203	225	248			3.75	0.15					111
MRB1A06		6	16	306	340	374			4.5	0.15					106
MRB1A12		12	32	1260	1400	1540			9	0.7					103
MRB1A24		24	57	3906	4340	4774			18	1.4					133
MRB2A05		5	9	95	105	116			3.75	0.15					238
MRB2A06		6	12	162	180	198			4.5	0.15					200
MRB2A12		12	24	657	730	803			9	0.7					197
MRB2A24		24	45	2250	2500	2750			18	1.4					230
MRB3A05		5	8	74	82	90			3.75	0.15					305
MRB3A06		6	11	117	130	143			4.5	0.15					277
MRB3A12		12	22	513	570	627			9	0.7					253
MRB3A24		24	36	1386	1540	1694			18	1.4					374
MRB4A05		5	8	54	60	66			3.75	0.15					417
MRB4A06		6	10	90	100	110			4.5	.15					360
MRB4A12		12	16	248	275	303			9	0.7					524
MRB4A24		24	32	981	1090	1199			18	1.4					528
MRB5A05		5	7	41	45	50			3.75	0.15					
MRB5A06		6	8	63	70	77			4.5	0.15					514
MRB5A12		12	17	252	280	308			9	0.7					514
MRB5A24		24	30	828	920	1012			18	1.4					626
MRB6A05		5	6	29	32	35			3.75	0.15					781
MRB6A06		6	7	45	50	55			4.5	0.15					720
MRB6A12		12	15	189	210	231			9	0.7					686
MRB6A24		24	31	810	900	990			18	1.4					640
MRB1B05		5	6	270	300	330			3.75	0.4					83
MRB1B12		12	15	1116	1240	1364			9	1					116
MRB1B24		24	30	5220	5800	6380			18	2					99
MRB2B05		5	6	74	82	90			3.75	0.4					305
MRB2B12		12	15	513	570	627			9	1					253
MRB2B24		24	30	2097	2330	2563			18	2					247
MRB1N05		5		45	50	55			3.75	0.4					500
MRB1N06		6		74	82	90			4.5	0.5					440
MRB1N12		12		207	230	253			9	1					626
MRB1N24		24		810	900	990			18	2					640
MRB2N05		5		25	28	31			3.75	0.4					893
MRB2N06		6		41	45	50			4.5	0.5					800
MRB2N12		12		167	185	204			9	1					778
MRB2N24		24		720	800	880			18	2					720
MRB1L01		5		81	90	99			3.75	Latch					N/A
MRB2L02		5		99	110	121			3.75	Latch					N/A
922A05C1C		5		180	200	220			3.75	0.4					125
922A06C1C		6		243	270	297			4.5	0.5					133
922A12C1C		12		972	1080	1188			9	1					133
922A24C1C		24		3888	4320	4752			18	2					133

1" x 0.1" GRID RELAYS

MRB ■ 922A

COIL SPECIFICATIONS

Units	Coil Voltage			Coil Resistance			Operate Voltage			Release Voltage		
	Volts			Ω			Volts			Volts		
Conditions				±10% (25°C)			Must operate by (25°C)			Must release by (25°C)		
Part #	Min	Typ	Max	Min	Typ	Max	Min	Typ	Max	Min	Typ	Max
922A05C2C		5		90	100	110			3.75	0.4		
922A06C2C		6		131	145	160			4.5	0.5		
922A12C2C		12		567	630	693			9	1		
922A24C2C		24		2268	2520	2772			18	2		
922A05C3C		5		68	75	83			3.75	0.4		
922A06C3C		6		81	90	99			4.5	0.5		
922A12C3C		12		324	360	396			9	1		
922A24C3C		24		1188	1320	1452			18	2		
922A05C4C		5		45	50	55			3.75	0.4		
922A06C4C		6		63	70	77			4.5	0.5		
922A12C4C		12		252	280	308			9	1		
922A24C4C		24		1008	1120	1232			18	2		
MRB1A1505		5		203	225	248			3.75	0.15		
MRB1A1506		6		306	340	374			4.5	0.15		
MRB1A1512		12		1260	1400	1540			9	0.7		
MRB1A1524		24		3906	4340	4774			18	1.4		
MRB2A1505		5		72	80	88			3.75	0.15		
MRB2A1506		6		117	130	143			4.5	0.15		
MRB2A1512		12		513	570	627			9	0.7		
MRB2A1524		24		1395	1550	1705			18	1.4		
MRB3A1505		5		54	60	66			3.75	0.15		
MRB3A1506		6		90	100	110			4.5	0.15		
MRB3A1512		12		405	450	495			9	0.7		
MRB3A1524		24		981	1090	1199			18	1.4		
MRB4A1505		5		29	32	35			3.75	0.15		
MRB4A1506		6		45	50	55			4.5	0.15		
MRB4A1512		12		189	210	231			9	0.7		
MRB4A1524		24		810	900	990			18	1.4		

MECHANICAL DIMENSIONS

DIMENSIONS
mm
(inches)

1.0 x 0.1 1A

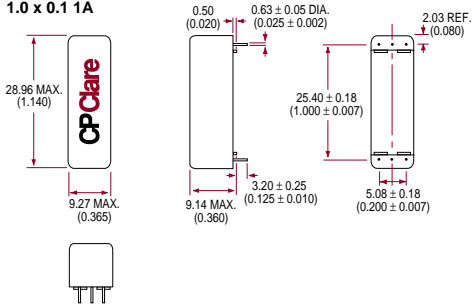

1.0 x 0.1 1A

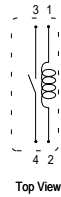

1.0 x 0.1 2A/1C/1B/1L

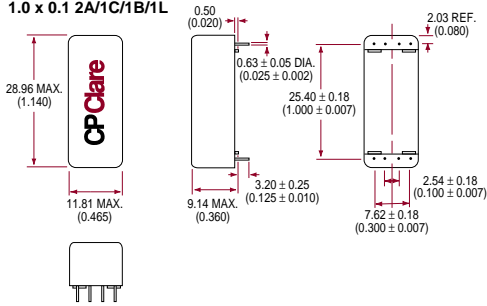

1.0 x 0.1 2A

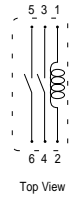

1.0 x 0.1 1B

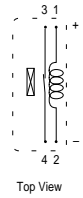

1.0 x 0.1 1C

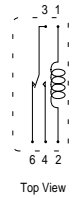

1.0 x 0.1 1L

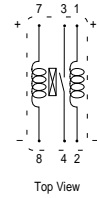

1.0 x 0.1 3A/2B/1N/2L/2C

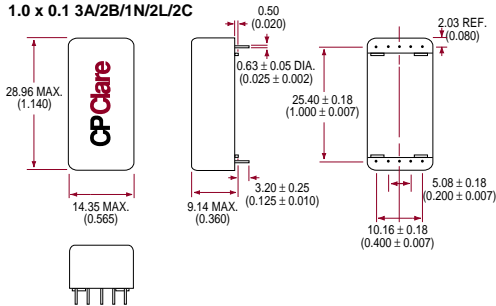

1.0 x 0.1 3A

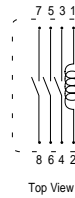

1.0 x 0.1 2B

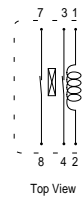

1.0 x 0.1 2C

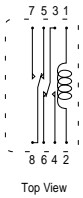

1.0 x 0.1 1N

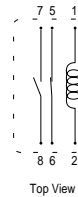

1.0 x 0.1 2L

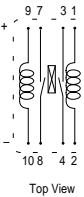

1" x 0.1" GRID RELAYS

MRB ■ 922A

MECHANICAL DIMENSIONS

DIMENSIONS
mm
(inches)

1.0 X 0.1 4A

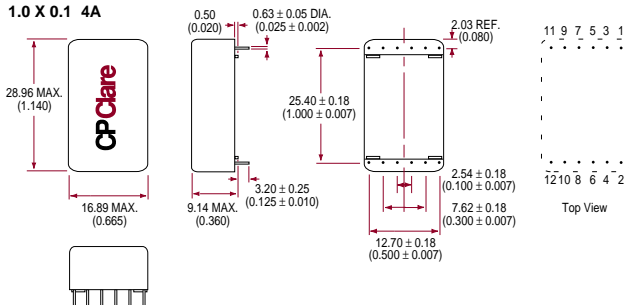

1.0 X 0.1 4A

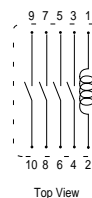

1.0 x 0.1 5A/2N/3C

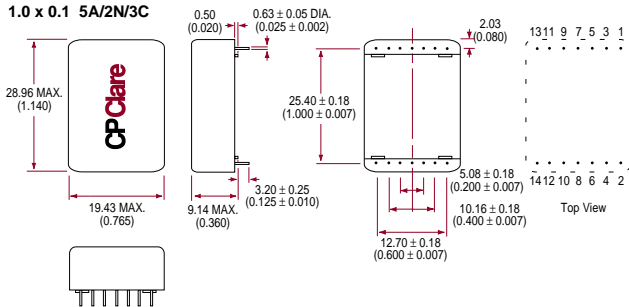

1.0 x 0.1 5A

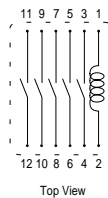

1.0 x 0.1 2N

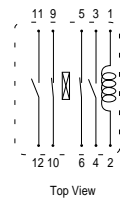

1.0 x 0.1 3C

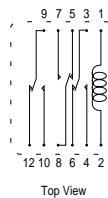

1.0 x 0.1 6A/4C

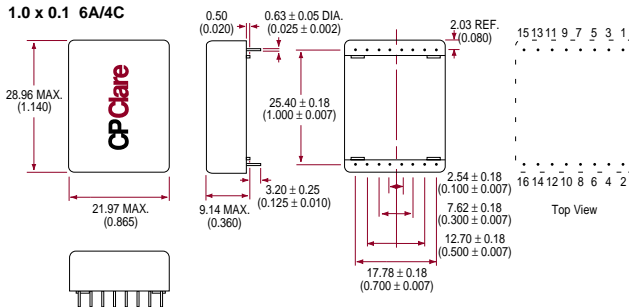

1.0 x 0.1 6A

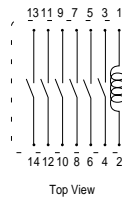

1.0 x 0.1 4C

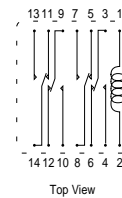

MECHANICAL DIMENSIONS

DIMENSIONS
mm
(inches)

1.0 x .15 1A

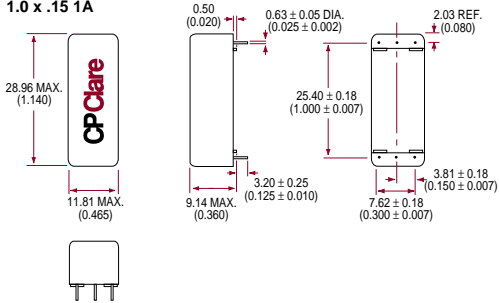

1.0 x .15 1A

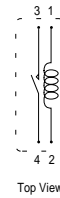

1.0 x .15 2A

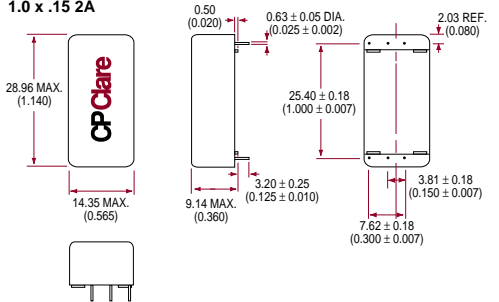

1.0 x .15 2A



1.0 x .15 3A

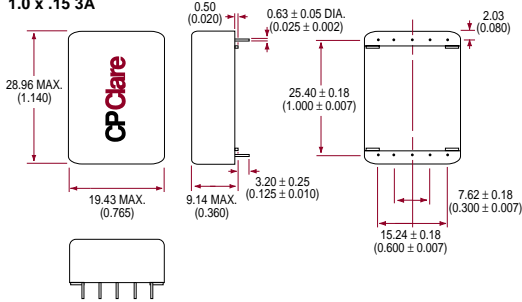

1.0 x .15 3A



1.0 x .15 4A

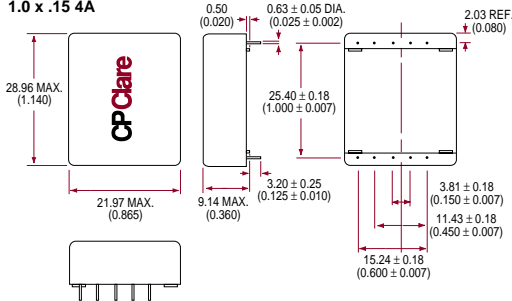

1.0 x .15 4A



ORDERING INFORMATION

A complete part number is represented by the digits below.

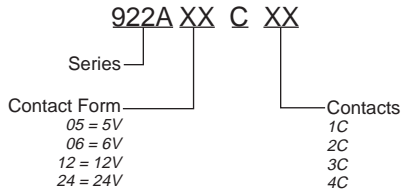
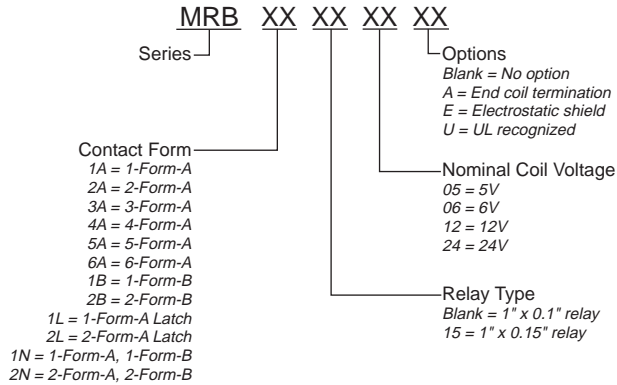



DESCRIPTION

CP Clare's ATE Series reed relays are designed for use in integrated circuit test systems and similar instrument grade applications. Their small size and magnetic shielding allow for the high density packing required when used on custom load boards. Some models are available with a coaxial shield which provides a 50Ω characteristic impedance. These relays are ideally suited for carrying fast digital pulses and low-power, high-frequency signals. All ATE relays have hermetically sealed contacts, which provide long life and high reliability.

FEATURES

- Small size
- Magnetically shielded
- Coaxial shield for 50Ω impedance
- RF transmission up to 500MHz
- Fast digital pulse applications (<200 ps)
- Low capacitance
- Fast switching speed (up to 500 Hz)
- Hermetically sealed contacts
- Designed for direct PC board or socket mounting

APPLICATIONS

- IC tester load boards and performance boards
- High frequency communications
- High frequency scanners
- Mixed signal testers
- Basic testers
- RF Switching

RATINGS (@ 25° C)

Parameter	Min	Typ	Max	Units
Contact Rating (Some models)		10	50	Watts
Switching Voltage (Some Models)		200	400	Volts
Isolation Voltage Input to Output	1000			Vdc
Operational Temperature	-20		+85	°C
Storage Temperature	-35		+100	°C

(See detailed specifications for more information.)

ATE SERIES REED RELAYS

RF & Automatic Test Equipment

SPECIFICATIONS

PARAMETER	CONDITIONS	SYMBOL	ATE11AXX1X			ATE21AXX2X			UNITS
			MIN	TYP	MAX	MIN	TYP	MAX	
<div style="display: flex; justify-content: space-around;"> 1-Form-A E/S Shield 1-Form-A Coaxial Shield </div>									
Contact Ratings									
Switching Voltage	Max DC/Peak Resistive	V _L	-	-	200	-	-	200	Volts
Switching Current	Max DC/Peak Resistive	I _L	-	-	0.5	-	-	0.5	Amps
Carry Current	Max DC/Peak Resistive	I _c	-	-	1	-	-	1	Amps
Contact Rating	Max DC/Peak Resistive	-	-	-	10	-	-	10	Watts
Life Expectancy	Signal Level 1.0V, 10mA	-	-	500	-	-	500	-	x10 ⁶ Ops
Rated Loads	-	-	10	-	-	10	-	-	x10 ⁶ Op
Static Contact Resistance	50mV, 10mA	CR	-	-	150	-	-	150	mΩ
Dynamic Contact Resistance	0.5V, 50mA at 100 Hz, 1.5 msec	DCR	-	-	200	-	-	200	mΩ
Contact Material	-	-	-	Rh	-	-	Rh	-	-
Relay Specifications									
Insulation Resistance	Between all isolated pins at 100V, 25°C, 40%RH	IR	10 ¹¹	-	-	10 ¹¹	-	-	Ω
Capacitance Across Open Contacts	Shield Floating	-	-	0.6	-	-	0.6	-	pF
	Shield Guarding	-	-	0.15	-	-	0.15	-	pF
Dielectric Strength	Between Contacts	-	250	-	-	250	-	-	VDC/Peak AC
	Contacts to Shield	I/O	250	-	-	250	-	-	VDC/Peak AC
Operate Time, including bounce no bounce - ATE5/ATE8)	Contacts/Shield to Coil	I/O	1000	-	-	1000	-	-	VDC/Peak AC
	At Nominal coil voltage, 30 Hz Square Wave	T _{OP}	-	-	0.5	-	-	0.55	ms
Release Time	Zener-Diode Suppression	T _{REL}	-	0.1	-	-	0.1	-	ms
RF Characteristics									
Isolation	at 500 MHz	-	-	n/a	-	-	28	-	dB
Insertion Loss	at 500 MHz	-	-	n/a	-	-	0.3	-	dB
VSWR	at 500 MHz	-	-	n/a	-	-	1.2	-	-
Rise Time	-	-	-	n/a	-	-	150	-	ps
Characteristic Impedance	-	-	-	n/a	-	45	50	60	Ω
Environmental Ratings									
Storage Temperature	-	T _A	-35	-	+100	-35	-	+100	°C
Operating Temperature	-	T _O	-20	-	+85	-20	-	+85	°C
Soldering Temperature	Applied to pin, 5 sec. max.	-	-	-	+250	-	-	+250	°C
Vibration Resistance	1 Hz - 2000 Hz	G	-	-	20	-	-	20	Gs
Shock Resistance	11±1ms, 1/2 Sine Wave	S	-	-	50	-	-	50	Gs
Weight	-	-	-	1.2	-	-	1.2	-	grams
Schematic Diagrams (Top View)									

PERFORMANCE GRAPHS

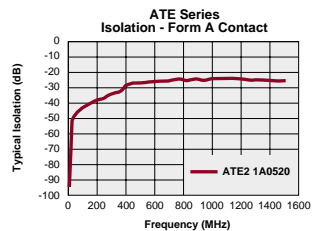
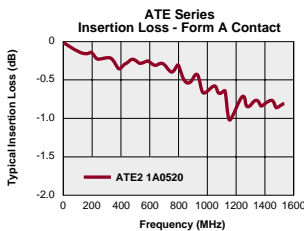
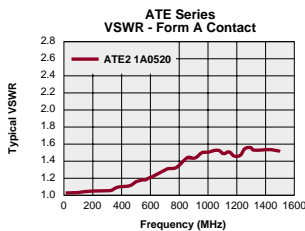

SPECIFICATIONS

ATE31CXXXX

1-Form-C
Dry Reed

ATE41AXXXX

1-Form-A
High Reliability

PARAMETER	CONDITIONS	SYMBOL	MIN	TYP	MAX	MIN	TYP	MAX	UNITS
Contact Ratings									
Switching Voltage	Max DC/Peak Resistive	V _L	-	-	125	-	-	200	Volts
Switching Current	Max DC/Peak Resistive	I _L	-	-	0.25	-	-	0.5	Amps
Carry Current	Max DC/Peak Resistive	I _c	-	-	0.75	-	-	1	Amps
Contact Rating	Max DC/Peak Resistive	-	-	-	3	-	-	10	Watts
Life Expectancy	Signal Level 1.0V, 10mA	-	-	100	-	-	500	-	x10 ⁶ Ops
Rated Loads	-	-	-	5	-	-	10	-	x10 ⁶ Op
Static Contact Resistance	50mV, 10mA	CR	-	-	150	-	-	150	mΩ
Dynamic Contact Resistance	0.5V, 50mA at 100 Hz, 1.5 msec	DCR	-	-	200	-	-	200	mΩ
Contact Material	-	-	-	Ru	-	-	Ru	-	-
Relay Specifications									
Insulation Resistance	Between all isolated pins at 100V, 25°C, 40%RH	IR	10 ⁹	-	-	10 ¹¹	-	-	Ω
Capacitance Across Open Contacts	Shield Floating	-	-	1.3	-	-	0.6	-	pF
	Shield Guarding	-	-	0.8	-	-	0.2	-	pF
Dielectric Strength	Between Contacts	-	200	-	-	250	-	-	VDC/Peak AC
Contacts to Shield	-	I/O	250	-	-	250	-	-	VDC/Peak AC
Contacts/Shield to Coil	-	I/O	1000	-	-	1000	-	-	VDC/Peak AC
Operate Time, including bounce no bounce - ATE5/ATE8)	At Nominal coil voltage, 30 Hz Square Wave	T _{OP}	-	0.5	-	-	0.5	-	ms
Release Time	Zener-Diode Suppression	T _{REL}	-	0.1	-	-	0.1	-	ms
RF Characteristics									
Isolation	at 500 MHz	-	-	30 ⁽¹⁾	-	-	38 ⁽¹⁾	-	dB
Insertion Loss	at 500 MHz	-	-	0.4 ⁽¹⁾	-	-	0.4 ⁽¹⁾	-	dB
VSWR	at 500 MHz	-	-	1.4 ⁽¹⁾	-	-	1.3 ⁽¹⁾	-	-
Rise Time	-	-	-	150 ⁽¹⁾	-	-	150 ⁽¹⁾	-	ps
Characteristic Impedance	-	-	-	50 ⁽¹⁾	-	-	50 ⁽¹⁾	-	Ω
Environmental Ratings									
Storage Temperature	-	T _A	-35	-	+100	-35	-	+100	°C
Operating Temperature	-	T _O	-20	-	+85	-20	-	+85	°C
Soldering Temperature	Applied to pin, 5 sec. max.	-	-	-	+250	-	-	+250	°C
Vibration Resistance	1 Hz - 2000 Hz	G	-	-	20	-	-	20	Gs
Shock Resistance	11±1ms, 1/2 Sine Wave	S	-	-	50	-	-	50	Gs
Weight	-	-	-	-	1.2	-	-	1.2	grams
Schematic Diagrams									
(Top View)	-	-							-

Notes: ⁽¹⁾Measurements taken with coaxial shield version.

⁽²⁾E/S shield on pin #7, Coaxial shield on 6 & 7.

PERFORMANCE GRAPHS

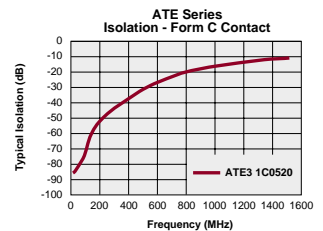
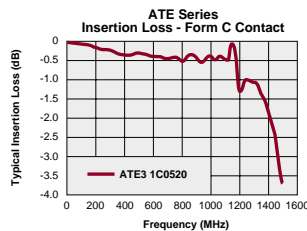
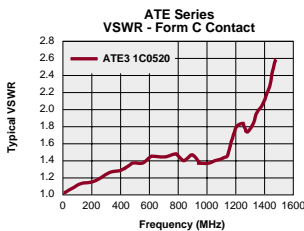

ATE SERIES REED RELAYS

RF & Automatic Test Equipment

SPECIFICATIONS

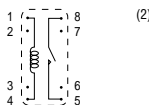
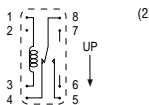
PARAMETER	CONDITIONS	SYMBOL	ATE61AXXXX 1-Form-A High Voltage			ATE71AXXXX 1-Form-A 500Ω Coil Resistance			UNITS
			MIN	TYP	MAX	MIN	TYP	MAX	
Contact Ratings									
Switching Voltage	Max DC/Peak Resistive	V _L	-	-	400	-	-	200	Volts
Switching Current	Max DC/Peak Resistive	I _L	-	-	0.5	-	-	0.5	Amps
Carry Current	Max DC/Peak Resistive	I _c	-	-	1	-	-	1	Amps
Contact Rating	Max DC/Peak Resistive	-	-	-	10	-	-	10	Watts
Life Expectancy	Signal Level 1.0V, 10mA	-	-	500	-	500	-	-	x10 ⁶ Ops
Rated Loads	-	-	-	10	-	10	-	-	x10 ⁶ Op
Static Contact Resistance	50mV, 10mA	CR	-	-	150	-	-	150	mΩ
Dynamic Contact Resistance	0.5V, 50mA at 100 Hz, 1.5 msec	DCR	-	-	200	-	-	200	mΩ
Contact Material	-	-	-	Ru	-	-	Ru	-	-
Relay Specifications									
Insulation Resistance	Between all isolated pins at 100V, 25°C, 40%RH	IR	10 ¹¹	-	-	10 ¹¹	-	-	Ω
Capacitance Across Open Contacts	Shield Floating	-	-	0.7	-	-	0.6	-	pF
	Shield Guarding	-	-	0.1	-	-	0.2	-	pF
Dielectric Strength	Between Contacts	-	1000	-	-	250	-	-	VDC/Peak AC
	Contacts to Shield	I/O	1000	-	-	250	-	-	VDC/Peak AC
Contacts/Shield to Coil	I/O	1000	-	-	-	1000	-	-	VDC/Peak AC
Operate Time, including bounce Release Time	At Nominal coil voltage, Zener-Diode Suppression	T _{OP}	-	0.25	-	-	0.5	-	ms
		T _{REL}	-	0.1	-	-	0.1	-	ms
RF Characteristics									
Isolation	at 500 MHz	-	-	28 ⁽¹⁾	-	-	28 ⁽¹⁾	-	dB
Insertion Loss	at 500 MHz	-	-	0.3 ⁽¹⁾	-	-	0.3 ⁽¹⁾	-	dB
VSWR	at 500 MHz	-	-	1.2 ⁽¹⁾	-	-	1.2 ⁽¹⁾	-	-
Rise Time	-	-	-	150 ⁽¹⁾	-	-	150 ⁽¹⁾	-	ps
Characteristic Impedance	-	-	-	50 ⁽¹⁾	-	-	50 ⁽¹⁾	-	Ω
Environmental Ratings									
Storage Temperature	-	T _A	-35	-	+100	-35	-	+100	°C
Operating Temperature	-	T _O	-20	-	+85	-20	-	+85	°C
Soldering Temperature	Applied to pin, 5 sec. max.	-	-	-	+250	-	-	+250	°C
Vibration Resistance	1 Hz - 2000 Hz	G	-	-	20	-	-	20	Gs
Shock Resistance	11±1ms, 1/2 Sine Wave	S	-	-	50	-	-	50	Gs
Weight	-	-	-	-	1.2	-	-	1.2	grams
Schematic Diagrams									
(Top View)	-	-							-

⁽¹⁾Measurements taken with coaxial shield version.

⁽²⁾E/S shield on pin #7, Coaxial shield on 6 & 7.

COIL SPECIFICATIONS

	Contact Form	Coil Voltage			Coil Resistance			Operate Voltage			Release Voltage		
Units		Volts			Ω			Volts			Volts		
Conditions					±10%, 25°C			Must operate by 25°C			Must release by 25°C		
Part #		Min	Typ	Max	Min	Typ	Max	Min	Typ	Max	Min	Typ	Max
ATE11A051X	1A		5	8	135	150	165			3.6	0.4		
ATE11A121X	1A		12	14	810	900	990			9	1		
ATE21A052X	1A		5	8	135	150	165			3.6	0.4		
ATE21A122X	1A		12	14	810	900	990			9	1		
ATE31C05XX	1C		5	9	207	230	253			3.75	0.4		
ATE31C12XX	1C		12	16	1350	1500	1650			9	1		
ATE41A05XX	1A		5	9	333	370	407			3.8	0.4		
ATE41A12XX	1A		12	16	1350	1500	1650			9.0	1		
ATE61A05XX	1A		5	9	135	150	165			3.75	0.4		
ATE61A12XX	1A		12	16	810	900	990			9	1		
ATE71A05XX	1A		5	8	450	500	550			3.75	0.4		

MECHANICAL DIMENSIONS

DIMENSIONS
mm
(inches)

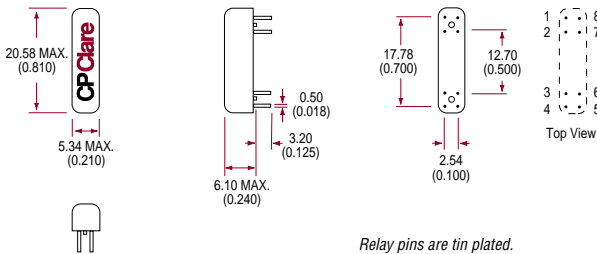

Relay pins are tin plated.
Gold plated pins are available
as a special order.

ORDERING INFORMATION

A complete part number is represented by the digits below.
For example, ATE41A0500 is a model 4 ATE series relay with 1-Form-A contacts, 5V coil voltage, standard pin and no shielding options.

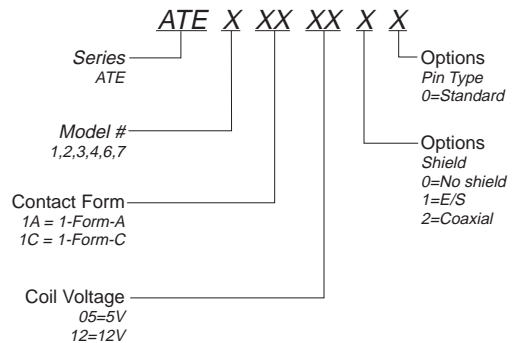

Clare Universal Package



DESCRIPTION

The CUP Series has become a standard in the European relay market due to its versatile switch and schematic options. The staggered pin layout gives more space and allows for higher isolation from pin to pin on the PC board when compared to 1.0" x 0.1" relays. There is a choice between plastic and metal covers, as well as non-encapsulated types for lower capacitance. The CUPV models offer high input to output isolation and are BS EN 60950 approved.

FEATURES

- Standard nominal coil voltages include 5, 12 and 24 volts
- Available with plastic and metal can housings
- Designed to meet the most stringent telecommunications specifications on a worldwide basis
- Ideal for optional high isolation between input and output (up to 4000Vrms)

APPLICATIONS

- Telecom
- Process control
- General purpose electronics
- Industrial
- Security

APPROVALS

- Consult factory for PTB approved types
- UL Recognized
- EN60950 certified CUPV types

RATINGS (@ 25° C)

Parameter	Min	Typ	Max	Units
Switching Voltage Switch option 1			200	Volts
Switching Current Switch option 1			0.75	Amps
Carry Current Switch option 1			2	Amps
Switching Frequency Switch option 1			500	Hz
Contact Resistance Switch option 1			200	mΩ
CUPV Switch option 1			200	mΩ

(See detailed specifications for more information.)

SPECIFICATIONS

CUP C, E, P

Switch Type 1
Dry Reed
DYAD®

CUP V

Switch Type 1
DYAD®

All parameters are at 25°C unless otherwise stated.

PARAMETER	CONDITIONS	SYMBOL	MIN	TYP	MAX	MIN	TYP	MAX	UNITS
Contact Ratings									
Switching Voltage	Max DC/PeakAC Resistive	V_L	-	-	200	-	-	200	Volts
Switching Current	Max DC/PeakAC Resistive	I_L	-	-	0.75	-	-	0.75	Amps
Carry Current	Max DC/PeakAC Resistive	I_C	-	-	2	-	-	2	Amps
Contact Rating	Max DC/PeakAC Resistive	-	-	-	10	-	-	10	Watts
Life Expectancy	Signal Level 1.0 V 10mA	-	-	500	-	300	500	-	x10 ⁶ Ops
	Rated Loads ⁽¹⁾	-	-	-	-	-	-	-	x10 ⁶ Ops
Static Contact Resistance	50mV, 10mA	CR	-	-	200	-	-	200	mΩ
Contact Material		-	-	Ru	-	-	Ru	-	-
Relay Specifications									
Insulation Resistance	Across Open Contacts	IR	10 ¹⁰	-	-	10 ¹⁰	-	-	Ω
	Contact to Coil	-	10 ¹⁰	-	-	10 ¹⁰	-	-	Ω
Capacitance	Across Open Contacts	-	-	1	1.5	-	1.3	2.5	pF
	Open Contact to Coil	-	-	2.5	3	-	3.75	5	pF
	Closed Contact to Coil	-	-	5	5.5	-	4	5.5	pF
Dielectric Strength	Between Contacts	-	350	-	-	350	-	-	VDC/Peak AC
	Contacts to Coil	I/O	2800	-	-	5600	-	-	VDC/Peak AC
Operate Time, no bounce (bounce included)	At Nominal Coil Voltage 10Hz Square Wave	T_{OP}	-	0.55	1 ⁽²⁾	-	0.55	1	ms
Release Time	Zener-Diode Suppression	T_{REL}	-	0.5	1.3	-	0.6	1	ms
Environmental Ratings									
Storage Temperature		T_A	-40	-	+105	-40	-	+105	°C
Operating Temperature		T_O	-40	-	+85	-40	-	+85	°C
Soldering Temperature	Applied to pins, 5 sec. max.	-	-	-	+260	-	-	+260	°C
Vibration Resistance (Survival)	10Hz - 500Hz	G	-	-	20	-	-	-	Gs
	5Hz - 2000 Hz (Sw type 1)	-	-	-	-	-	-	20	Gs
Shock Resistance (Survival)	11±1ms, 1/2 Sine Wave	S	-	-	50	-	-	50	Gs
Weight (1A)		-	-	3.8	-	-	8	-	grams
Weight (2A2B/5A)		-	-	15.8	-	-	15.8	-	grams

⁽¹⁾ Consult factory for life requirements

⁽²⁾ 1.5 msec. maximum for 4&5 form A relays, 1.5 msec. maximum for 5 form A, 2 form B and 2A2B relays

COIL SPECIFICATIONS

	Coil Voltage			Coil Resistance			Operate Voltage			Release Voltage		
Units	Volts			Ω			Volts			Volts		
Conditions				±10%, 25°C			Must operate by 25°C			Must release by 25°C		
Part #	Min	Typ	Max	Min	Typ	Max	Min	Typ	Max	Min	Typ	Max
CUP E 001A105⁽¹⁾		5	12	126	140	154			3.5	0.28		
CUP E 001A112		12	29	769	855	940			8.4	0.7		
CUP E 001A124		24	57	2956	3285	3613			16.8	1.4		
CUP E 002A105^(1,2)		5	9	63	70	77			3.5	0.25		
CUP E 002A112		12	23	400	445	489			8.4	0.65		
CUP E 002A124		24	45	1530	1700	1870			16.8	1.30		
CUP V 10001⁽³⁾		5	12	472	525	577			3.5	0.28		
CUP V 10002		12	29	2700	3000	3300			8.4	0.7		
CUP V 10025		5	6	99	110	121			3.5	0.25		
CUP V 10019		12	14	567	630	693			8.4	0.7		
CUP V 10201		5	6	270	300	330			3.5	0.36		
CUP V 10202		12	14	1440	1600	1760			8.4	1.0		
CUP V 10301		5	6	112	125	137			3.5	0.3		
CUP V 10302		12	15	675	750	825			3.4	0.7		

⁽¹⁾ Other packages available: C = metal cover; E = plastic cover, fully sealed; P = metal cover, fully sealed; S = open version

⁽²⁾ Other contact forms available: 1A, 2A, 3A, 4A, 5A, 1B, 2B, 1A1B, 2A2B, 1L (Latch)

⁽³⁾ All CUPV models BS certified (4000 V_{RMS})

PERFORMANCE GRAPHS

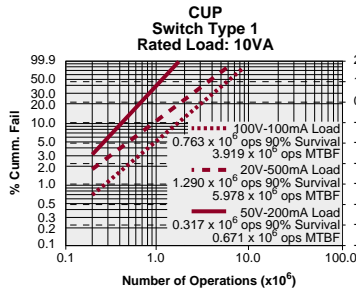

ORDERING INFORMATION

A complete part number is represented by the digits below.

CUP C, E, P

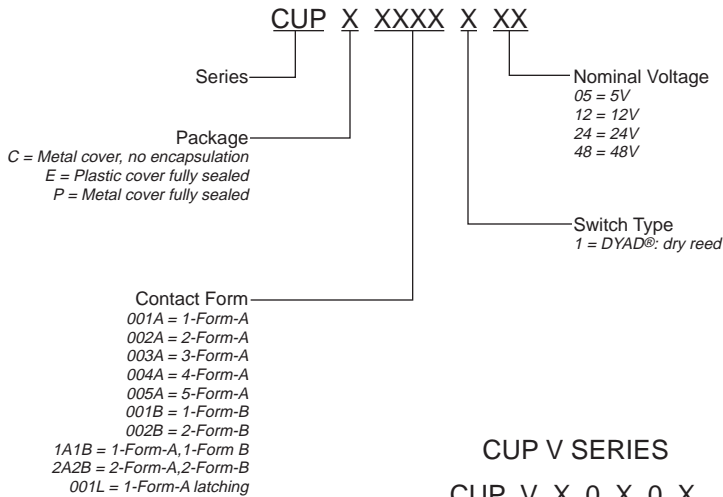

CUP V SERIES

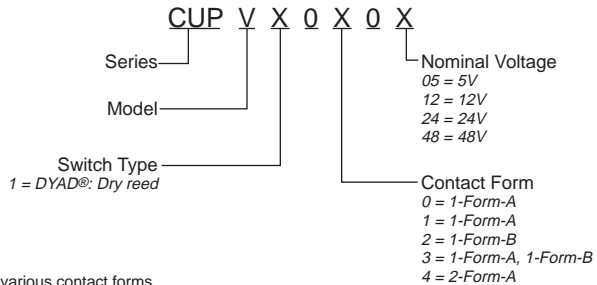

Consult factory for additional drawings & various contact forms.

MECHANICAL DIMENSIONS

DIMENSIONS
mm
(inches)

CUP C/CUP P 1A

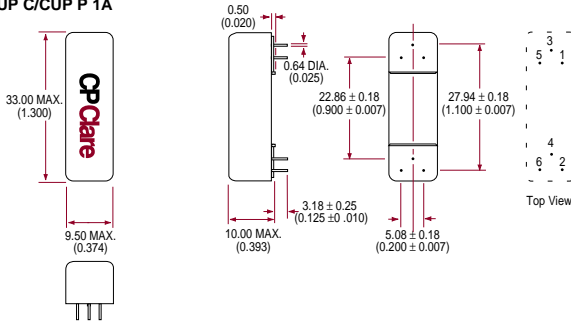

CUP C/CUP P 1A



CUP C/CUP P 2A/1B/1A(Latch)

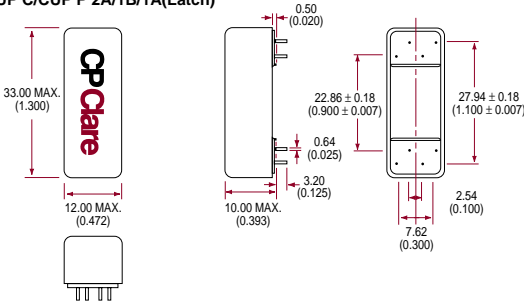

CUP C/CUP P 2A

CUP C/CUP P 1B

CUP C/CUP P 1A(Latch)

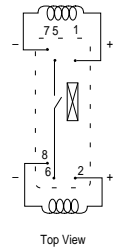
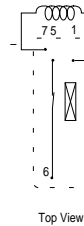
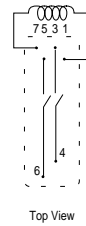

CUP C/CUP P 1A1B/2B/3A

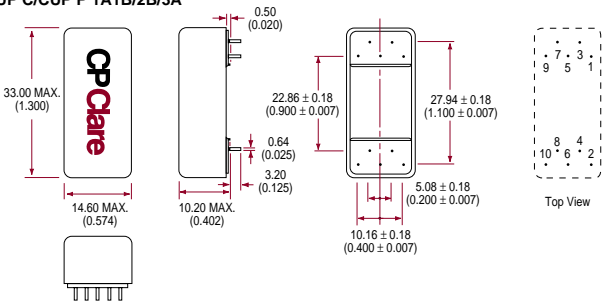

CUP C/CUP P 3A

CUP C/CUP P 2B

CUP C/CUP P 1A1B

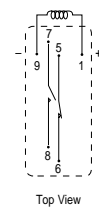
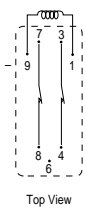
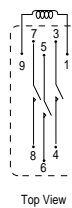

CUP P 5A/2A2B

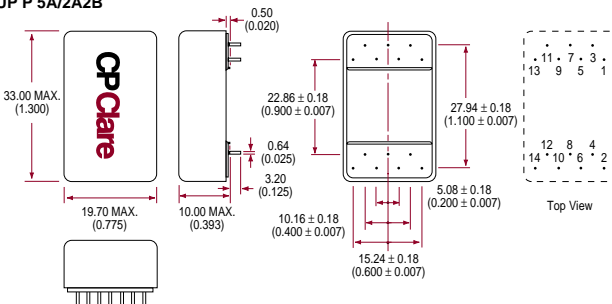

CUP P 5A

CUP P 2A2B

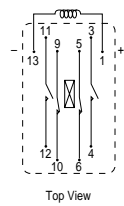
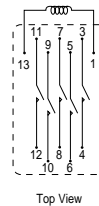

MECHANICAL DIMENSIONS

DIMENSIONS
mm
(inches)

CUP E/CUP V 1A

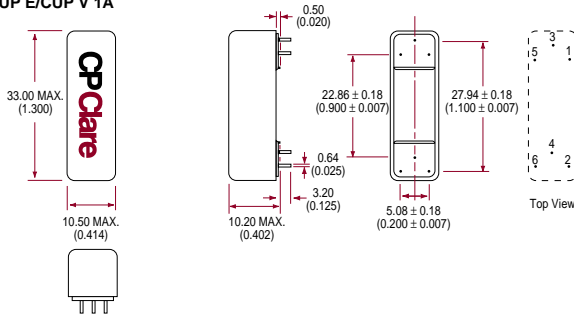

CUP E 1A

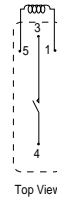

CUP V 1A

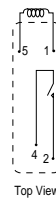

CUP E/CUP V 2A/1B/1A(Latch)

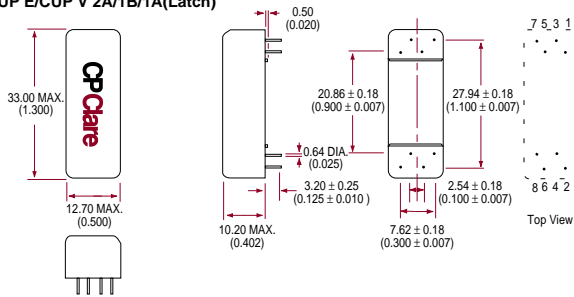

CUP E 2A

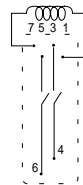

CUP E 1B

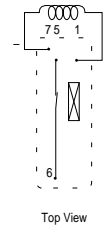

CUP E 1A(Latch)

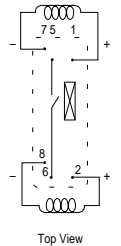

CUP V 2A



CUP V 1B

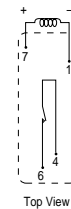

CUP E/CUP V 2B/3A/1A1B

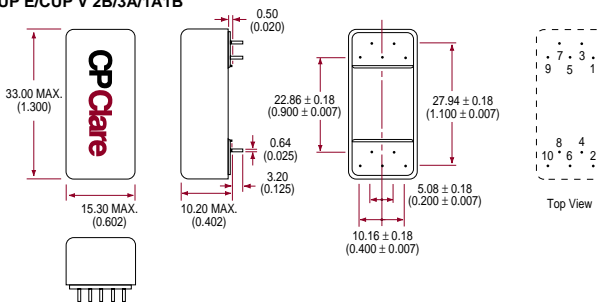

CUP E 3A



CUP E 2B



CUP E 1A1B

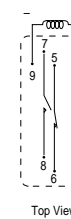

CUP V 1A1B



MECHANICAL DIMENSIONS

DIMENSIONS
mm
(inches)

CUP E 4A

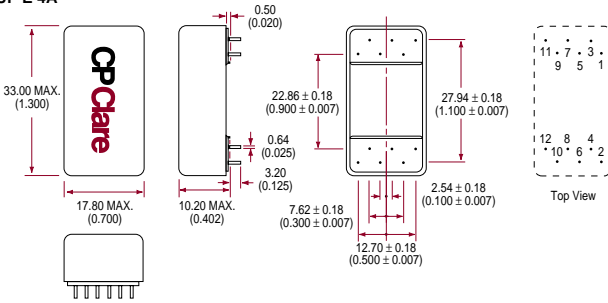

CUP E 4A

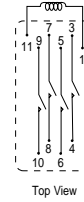

CUP E/CUP V 5A/2A2B

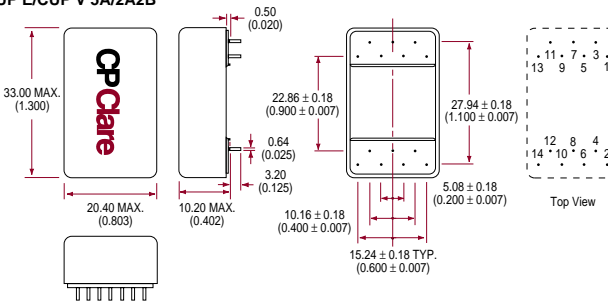

CUP E 5A

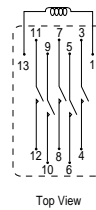

CUP E 2A2B

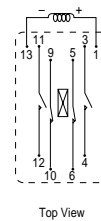

CUP V 2A2B

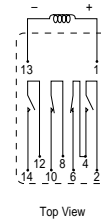



DESCRIPTION

The DIP Series' efficient packaging offers low input power with industry standard pin configurations. Models are available with 4000V input/output isolation for telecom and industrial applications. A variety of contact materials are available to meet life and load requirements of demanding applications. The sputtered ruthenium contacts are unaffected by polymer buildup and thus maintain low and stable contact resistance.

The DIP Series' current sensing models are available for telecom line loop requirements. Standard models can sense currents of up to several amps. They also can sense open or closed circuits, making them useful in industrial, avionic, and automotive applications as well.

FEATURES

- High coil resistance capability for low-power applications
- 3750VAC RMS input to output isolation
- Low coil resistance version available for Line Loop applications (Europe)
- Single & dual coil versions available

APPLICATIONS

- Telecom
- Current sensing
- Modems
- Industrial
- Avionics
- Automotive

APPROVALS

- IEC950, UL & CSA approvals pending

RATINGS (@ 25° C)

Parameter	Min	Typ	Max	Unit
Coil Power (some models)	30	-	-	mW
Switching Voltage (some models)	100	-	400	Volts
Switching Current	-	-	0.5	Amps
Open Contact Isolation	-	-	800	Volts
Contact/Coil Isolation	1500	-	3750	VAC RMS

(See detailed specifications for more information.)

DIP SERIES REED RELAYS

Low Power & Current Sensing

SPECIFICATIONS

All parameters are at 25°C unless otherwise stated.									
PARAMETER	CONDITIONS	SYMBOL	DIP31CXXXX			DIP41AXXXX			UNITS
			MIN	TYP	MAX	MIN	TYP	MAX	
			1-Form-C Standard Ruthenium Contact			1-Form-A Mini-DYAD® Ruthenium Contact			
Contact Ratings									
Switching Voltage	Max DC/Peak Resistive	V _L	0	-	125	0	-	200	Volts
Switching Current	Max DC/Peak Resistive	I _L	0	-	0.25	0	-	0.5	Amps
Carry Current	Max DC/Peak Resistive	I _c	0	-	0.5	0	-	1	Amps
Contact Rating	Max DC/Peak Resistive	-	-	-	3	-	-	10	Watts
Life Expectancy	Signal Level 1.0V, 10mA	-	-	200	-	-	500	-	x10 ⁶ Ops
	Rated Loads	-	-	5	-	-	10	-	x10 ⁶ Ops
Static Contact Resistance ⁽²⁾	50mV, 10mA	CR	-	-	150	-	-	150	mΩ
Dynamic Contact Resistance ⁽²⁾	0.5V, 50mA at 100Hz, 1.5 msec	DCR	-	-	200	-	-	200	mΩ
Contact Material		-	-	Ru	-	-	Ru	-	-
Relay Specifications									
Insulation Resistance	Between all isolated pins at 100V, 25°C, 40%RH	IR	10 ¹⁰	-	-	10 ¹⁰	-	-	Ω
Capacitance Across Open Contacts	1 KHz Test Signal	-	-	1.2	-	-	0.6	-	pF
Contact to Coil	1 KHz Test Signal	-	-	2.5	-	-	0.75	-	pF
Dielectric Strength	Between Contacts	-	200	-	-	250	-	-	VDC/Peak AC
	Contacts to Coil (Pin Option 1&3)	I/O	1500	-	-	3750	-	-	VAC RMS
	Contacts to Coil (Pin Option 2)	I/O	1500	-	-	1500	-	-	VAC RMS
Operate Time, including bounce	At Nominal coil voltage, 10Hz Square Wave	T _{OP}	-	1.5	-	-	0.4	-	ms
Release Time	Zener-Diode Suppression	T _{REL}	-	1.5	-	-	0.2	-	ms
Environmental Ratings									
Storage Temperature		T _A	-35	-	+100	-35	-	+100	°C
Operating Temperature		T _O	-20	-	+85	-20	-	+85	°C
Soldering Temperature	Applied to pin, 5 sec. max.	-	-	-	+250	-	-	+250	°C
Vibration Resistance	5Hz - 2000Hz (dry)	G	-	-	20	-	-	20	Gs
Shock Resistance	11±1ms, 1/2 Sine Wave	S	-	-	50	-	-	50	Gs
Weight		-	-	8	-	-	8	-	grams
Schematic Diagrams									
(Top View) Option 1									
Option 2 ⁽¹⁾									
Option 3									

⁽¹⁾ Optional electrostatic shield is tied to pin #9. On models with diode, pin #2 is positive.

⁽²⁾ For pin option 3, the contact resistance will increase by 0.02Ω due to series resistance of internal connections.

SPECIFICATIONS





DIP61AXXXX

1-Form-A
High Voltage
Ruthenium Contact

DIP100xx

1-Form-A
Mini-DYAD®
Current Sensing

All parameters are at 25°C unless otherwise stated.

PARAMETER	CONDITIONS	SYMBOL	MIN	TYP	MAX	MIN	TYP	MAX	UNITS
Contact Ratings									
Switching Voltage	Max DC/Peak Resistive	V_L	-	-	400	-	-	100	Volts
Switching Current	Max DC/Peak Resistive	I_L	-	-	0.5	-	-	0.5	Amps
Carry Current	Max DC/Peak Resistive	I_C	-	-	1	-	-	1	Amps
Contact Rating	Max DC/Peak Resistive	-	-	-	10	-	-	10	Watts
Life Expectancy	Signal Level 1.0V, 10mA	-	-	500	-	-	500	-	$\times 10^6$ Ops
	Rated Loads	-	-	5	-	-	10	-	$\times 10^6$ Ops
Static Contact Resistance ⁽²⁾	50mV, 10mA	CR	-	-	150	-	-	150	mΩ
Dynamic Contact Resistance ⁽³⁾	0.5V, 50mA at 100Hz, 1.5 msec	DCR	-	-	200	-	-	200	mΩ
Contact Material		-	-	Ru	-	-	Ru	-	-
Relay Specifications									
Insulation Resistance	Between all isolated pins at 100V, 25°C, 40%RH	IR	10^{10}	-	-	10^{10}	-	-	Ω
Capacitance Across	1 KHz Test Signal	Open Contacts	-	0.45	-	-	0.6	-	pF
		Contact to Coil	-	0.6	-	-	0.75	-	pF
Dielectric Strength	Between Contacts	-	800	-	-	200	-	-	VDC/Peak AC
	Contacts to Coil (Pin Options 1&3)	I/O	3750	-	-	3750	-	-	VAC RMS
	Contacts to Coil (Pin Option 2)	I/O	1500	-	-	-	-	-	VAC RMS
Operate Time, including bounce	At Nominal coil voltage, 30Hz Square Wave	T_{OP}	-	0.6	-	-	0.75	-	ms
Release Time	Zener-Diode Suppression	T_{REL}	-	0.2	-	-	0.1	-	ms
Environmental Ratings									
Storage Temperature		T_A	-35	-	+100	-35	-	+100	°C
Operating Temperature		T_0	-20	-	+85	-20	-	+85	°C
Soldering Temperature	Applied to pins, 5 sec. max.	-	-	-	+250	-	-	+250	°C
Vibration Resistance	5Hz - 2000Hz (Dry)	G	-	-	20	-	-	20	Gs
Shock Resistance	11 ± 1 ms, $\frac{1}{2}$ Sine Wave	S	-	-	50	-	-	50	Gs
Weight		-	-	8	-	-	8	-	grams
Schematic Diagrams									
(Top View) Option 1								(1)	
Option 2					(1)				
Option 3									

(1) Optional electrostatic shield is tied to pin #9. On models with diode, pin #2 is positive.

(2) For pin option 3, the contact resistance will increase by 0.02 Ω due to series resistance of internal connections.

DIP SERIES REED RELAYS

Low Power & Current Sensing

COIL SPECIFICATIONS

	Contact Form	Coil Voltage			Coil Resistance			Operate Voltage			Release Voltage		
Units		Volts			Ω			Volts			Volts		
Conditions					$\pm 10\%$, 25°C			Must operate by, 25°C			Must release by, 25°C		
Part #		Min	Typ	Max	Min	Typ	Max	Min	Typ	Max	Min	Typ	Max
DIP31C05XX	1-Form-C		5	11	450	500	550			3.6	0.4		
DIP31C12XX	1-Form-C		12	21	1575	1750	1925			9	1		
DIP31C24XX	1-Form-C		24	32	3600	4000	4400			18	2		
DIP41A05XX	1-Form-A		5	15	810	900	990			3.6	0.4		
DIP41A12XX	1-Form-A		12	26	2520	2800	3080			9	1		
DIP41A24XX	1-Form-A		24	32	3600	4000	4400			18	2		
DIP61A05XX	1-Form-A		5	8.5	270	300	330			3.6	0.4		
DIP61A12XX	1-Form-A		12	21	1575	1750	1925			9	1		
DIP61A24XX	1-Form-A		24	32	3600	4000	4400			18	2		

CURRENT SENSING RELAYS

	Contact Form	Nominal Coil Current			Coil Resistance			Operate Current			Release Current		
Units		Amps			Ω			Current			Current		
Conditions		25°C			25°C, $\pm 10\%$			Must operate by (25°C)			Must release by (25°C)		
Part #		Min	Typ	Max ¹	Min	Typ	Max	Min	Typ	Max	Min	Typ	Max
DIP10001	1-Form-A		0.02	0.23		9				0.015	0.004		
DIP10002	1-Form-A		0.02	0.18		15				0.015	0.004		
DIP10015	1-Form-A		0.15	1.5		0.2				0.15	0.015		
DIP10025	1-Form-A		0.25	2.3		0.1				0.25	0.025		
DIP10050	1-Form-A		0.5	2.5		0.08				0.5	0.05		
DIP10100	1-Form-A		1	3		0.06				1	0.1		

¹Continuous duty cycle

MECHANICAL DIMENSIONS

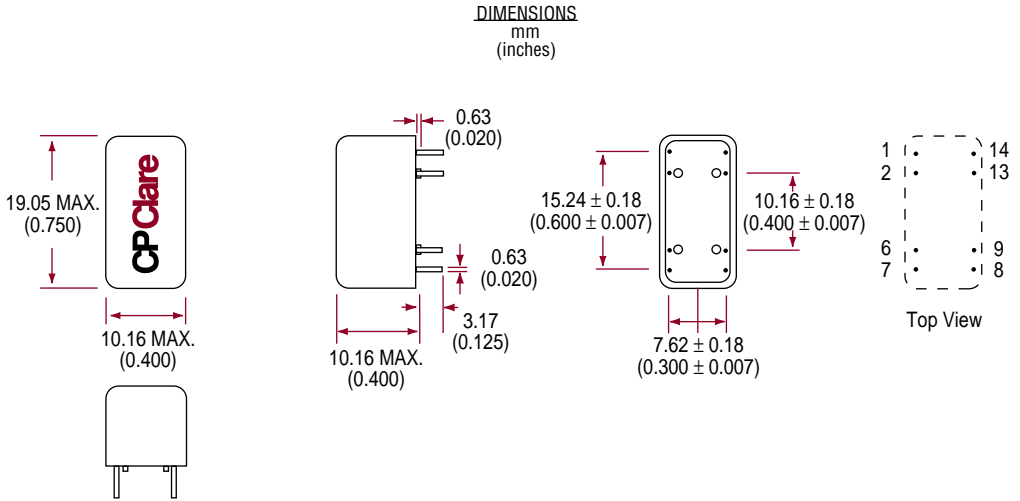

ORDERING INFORMATION

A complete part number is represented by the digits below.

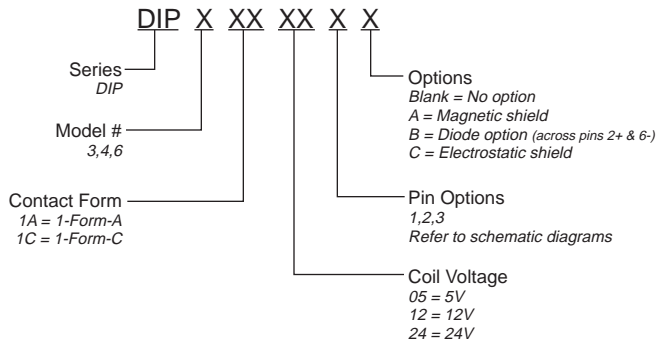

Current Sensing Relays

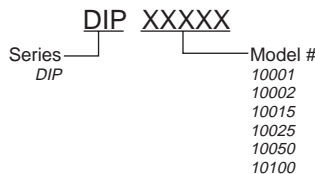

DIP 14 SERIES REED RELAYS

PRMA ■ DSS7 ■ PRME



DESCRIPTION

CP Clare's epoxy molded DIP 14 Series offers a variety of contacts and schematics to meet the needs of a wide range of applications. With switching up to 10 Watts and a 4000V isolation option, the DIP 14 Series is a relay package that allows for automatic insertion directly on PCBs as well as insertion into standard 14 Pin DIP sockets.

FEATURES

- Stable contact resistance over life
- 4000 Vac input-output isolation
- High insulation resistance
- Switching speed of 300Hz
- Long life > 500 million operations
- Epoxy molded for automatic board processing

APPLICATIONS

- Automatic test equipment
- Process control
- Industrial
- Telecom
- Datacom
- High-end security systems
- Signaling
- Metering

APPROVALS

- UL approval (DSS7 & PRMA)
- EN 60950 certified (DSS7)
- CSA approval (PRMA)

RATINGS (@ 25° C)

Parameter	Min	Typ	Max	Unit
Switching Voltage				
PRMA/PRME/DSS7			200	Volts
PRMA Form C			100	Volts
Switching Current				
PRMA/PRME/DSS7			0.5	Amps
PRMA Form C			0.25	Amps
Carry Current				
PRMA/PRME/DSS7			2	Amps
PRMA Form C			0.4	Amps
Switching Frequency				
PRMA/PRME/DSS7			500	Hz
PRMA Form C			50	Hz
Contact Resistance				
PRMA/PRME/DSS7			150	mΩ
PRMA Form C			200	mΩ

(See detailed specifications for more information.)

SPECIFICATIONS

All parameters are at 25°C unless otherwise stated.
Operate voltage, release voltage, and coil resistance will change approximately 0.4%/°C as ambient temperature varies.

PRMA
Molded 8 Pin
Form-C
Dry Reed

PRMA
Molded 8 Pin
Form-A&B
Dry Reed

PARAMETER	CONDITIONS	SYMBOL	MIN	TYP	MAX	MIN	TYP	MAX	UNITS
Contact Ratings									
Switching Voltage	Max DC/PeakAC Resistive	V_L	-		100	-	-	200	Volts
Switching Current	Max DC/PeakAC Resistive	I_L	-		0.25	-	-	0.5	Amps
Carry Current	Max DC/PeakAC Resistive	I_C	-		0.4	-	-	2	Amps
Contact Rating	Max DC/PeakAC Resistive		-		3	-	-	10	Watts
Life Expectancy	Signal Level 1.0V 10mA Related Loads ⁽¹⁾		-	20	-	300	500	-	$\times 10^6$ Ops
Static Contact Resistance	50mV, 10mA	CR	-		200	-	-	150	mΩ
Dynamic Contact Resistance	.5V, 50mA at 100Hz, 1.5 msec	DCR	-	N/A	-	-	N/A	-	mΩ
Contact Material			-	Rh	-	-	Ru	-	
Relay Specifications									
Insulation Resistance	Between all isolated pins at 100V, 25°C, 40% RH	IR	10^9	10^{10}	-	10^{10}	10^{12}	-	Ω
Capacitance	Across Open Contacts		-	2.5	3	-	0.7	1	pF
	Open Contact to Coil		-	3	3	-	1.5	2	pF
Dielectric Strength	Between Contacts		250	-	-	250	-	-	VDC/Peak AC
	Contacts to Coil	I/O	1400	-	-	1400	-	-	VDC/Peak AC
Operate Time, including bounce	At Nominal Coil Voltage 10Hz Square Wave	T_{OP}	-	1.5	2	-	.25	0.5	ms
Release Time	Zener-Diode Suppression	T_{REL}	-	1.5	3	-	.25	0.5	ms
Environmental Ratings									
Storage Temperature		T_A	-40	-	+105	-40	-	+105	°C
Operating Temperature		T_O	-40	-	+80	-40	-	+80	°C
Soldering Temperature	Applied to pins, 5 sec. max.		-	260	-	-	-	260	°C
Vibration Resistance ⁽²⁾ (Survival)	10 Hz - 500 Hz for PRMA Form A&B 5Hz - 500Hz for PRMA Form C	G	-	-	10	-	-	20	Gs
Shock Resistance (Survival)	11±1ms, 1/2 Sine Wave	S	-	-	50	-	-	100	Gs
Weight			-	1.5	-	-	1.5	-	grams

⁽¹⁾ Refer to life graphs

⁽²⁾ Use caution not to exceed vibration resistance limits while ultrasonically cleaning relays with DYAD switches. Contact CP Clare Engineering for more details/recommendations.

DIP 14 SERIES REED RELAYS

PRMA ■ DSS7 ■ PRME

SPECIFICATIONS

All parameters are at 25°C unless otherwise stated.
Operate voltage, release voltage, and coil resistance will change approximately 0.4%/°C as ambient temperature varies.

DSS7
Molded 4 Pin
Dry Reed

PRME
Molded 8 Pin
Low profile
Dry Reed

PARAMETER	CONDITIONS	SYMBOL	MIN	TYP	MAX	MIN	TYP	MAX	UNITS
Contact Ratings									
Switching Voltage	Max DC/PeakAC Resistive	V_L	-	-	200	-	-	200	Volts
Switching Current	Max DC/PeakAC Resistive	I_L	-	-	0.5	-	-	0.5	Amps
Carry Current	Max DC/PeakAC Resistive	I_C	-	-	2	-	-	2	Amps
Contact Rating	Max DC/PeakAC Resistive		-	-	10	-	-	10	Watts
Life Expectancy	Signal Level 1.0 V 10mA Related Loads ⁽¹⁾		300	500	-	300	500	-	$\times 10^6$ Ops
Static Contact Resistance	50mV, 10mA	CR	-	-	150	-	-	150	mΩ
Dynamic Contact Resistance	.5V, 50mA at 100Hz, 1.5 msec	DCR	-	N/A	-	-	N/A	-	mΩ
Contact Material			-	Ru	-	-	Ru	-	
Relay Specifications									
Insulation Resistance	Between all isolated pins at 100V, 25°C, 40% RH	IR	10^{10}	10^{12}	-	10^{10}	10^{12}	-	Ω
Capacitance	Across Open Contacts		-	0.7	1	-	0.8	1	pF
	Open Contact to Coil		-	1.5	2	-	1.5	2	pF
Dielectric Strength	Between Contacts		250	-	-	250	-	-	VDC/Peak AC
	Contacts to Coil	I/O	5600	-	-	1000	-	-	VDC/Peak AC
Operate Time, including bounce	At Nominal Coil Voltage 10Hz Square Wave	T_{OP}	-	0.25	0.5	-	0.25	1	ms
Release Time	Zener-Diode Suppression	T_{REL}	-	0.25	0.5	-	0.25	0.5	ms
Environmental Ratings									
Storage Temperature		T_A	-40	-	+105	-40	-	+105	°C
Operating Temperature		T_O	-40	-	+80	-40	-	+80	°C
Soldering Temperature	Applied to pins, 5 sec. max.		-	-	260	-	-	260	°C
Vibration Resistance ⁽²⁾ (Survival)	5Hz - 500Hz	G	-	-	20	-	-	20	Gs
Shock Resistance (Survival)	11±1ms, 1/2 Sine Wave	S	-	-	100	-	-	100	Gs
Weight			-	1.5	-	-	1.5	-	grams

⁽¹⁾ Refer to life graphs

⁽²⁾ Use caution not to exceed vibration resistance limits while ultrasonically cleaning relays with DYAD switches. Contact CP Clare Engineering for more details/recommendations.

COIL SPECIFICATIONS

	Contact Form	Coil Voltage			Coil Resistance			Operate Voltage			Release Voltage			Nominal Input Power		
Units		Volts			Ω			Volts			Volt			mW		
Conditions					±10% (25°C)			Must operate by (25°C)			Must release by (25°C)					
Part #		Min	Typ	Max	Min	Typ	Max	Min	Typ	Max	Min	Typ	Max	Min	Typ	Max
PRMA 1A05	1-Form-A		5	21	450	500	550			3.75	0.8					50
PRMA 1A12	1-Form-A		12	30	900	1000	1100			9	1					144
PRMA 1A24	1-Form-A		24	44	1935	2150	2365			18	2					268
PRMA 1B05	1-Form-B		5	6	450	500	550			3.75	0.8					50
PRMA 1B12	1-Form-B		12	14.5	900	1000	1100			9	1					144
PRMA 1B24	1-Form-B		24	29	1935	2150	2365			18	2					268
PRMA 1C05	1-Form-C		5	12	180	200	220			3.75	0.8					125
PRMA 1C12	1-Form-C		12	18	450	500	550			9	1					288
PRMA 1C24	1-Form-C		24	32	1935	2150	2365			18	2					268
PRMA 2A05	2-Form-A		5	11	126	140	154			3.75	0.8					179
PRMA 2A12	2-Form-A		12	21	450	500	550			9	1					288
PRMA 2A24	2-Form-A		24	44	1935	2150	2365			18	2					268
PRMA 10037	1-Form-A		5	15	342	380	418			3.75	0.8					66
PRMA 10038	1-Form-A		12	19	477	530	583			9	1					272
PRMA 10039	1-Form-A		24	32	1800	2000	2200			18	2					288
DSS7 1A05	1-Form-A		5	21	450	500	550			3.75	0.8					50
DSS7 1A12	1-Form-A		12	30	900	1000	1100			9	1					144
DSS7 1A24	1-Form-A		24	44	1935	2150	2365			18	2					268
PRME 25005	1-Form-A		5	19	450	500	550			3.8	0.8					50
PRME 15005	1-Form-A		5	15	342	380	418			3.5	1					66
PRME 15002	1-Form-A		12	19	477	530	583			8	1					272
PRME 15003	1-Form-A		24	32	1800	2000	2200			16	2					288

PERFORMANCE GRAPHS

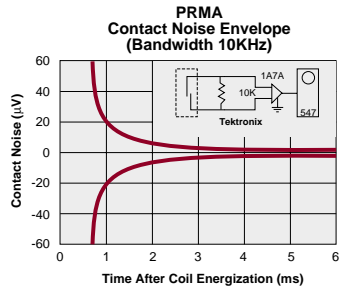
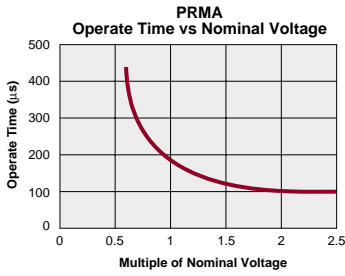
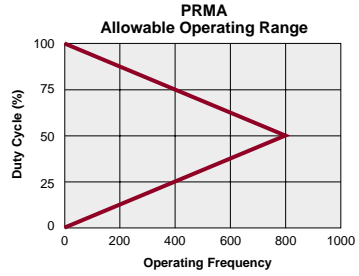
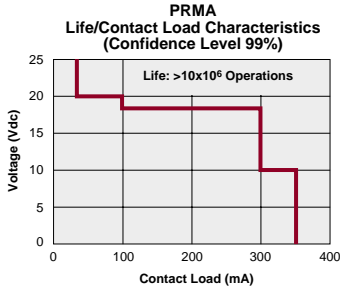

DIMENSIONS
mm
(inches)

MECHANICAL DIMENSIONS

PRMA

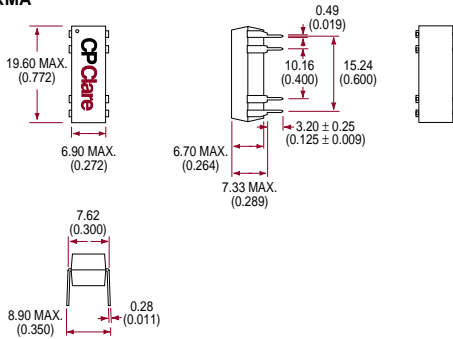

PRMA 1A

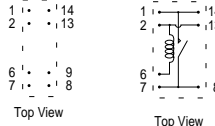

Options:
Diode - pin #2 is positive
Electrostatic shield - pin 9

PRMA 1B

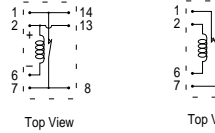

Options:
Diode - pin #2 is positive
Electrostatic shield - pin 9

PRMA 1C

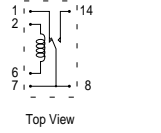

Options:
Diode - pin #2 is positive
Electrostatic shield - pin 9

PRMA 2A

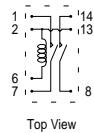

Options:
Diode - pin #2 is positive
Electrostatic shield - pin 9

PRMA 10037/10038/10039

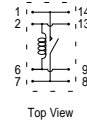

Options:
Diode - pin #2 is positive
Electrostatic shield - pin 9

PRME

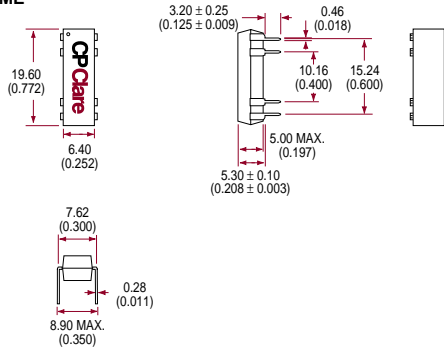

PRME

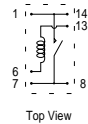

Options:
Diode - pin #13 is positive
Electrostatic shield - pin 9

DSS7

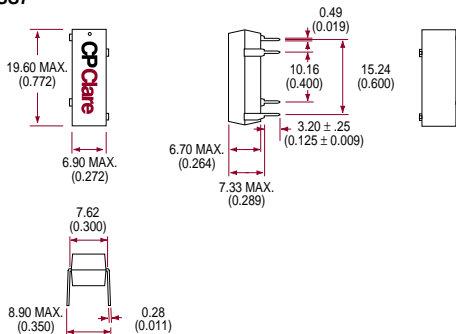

DSS7

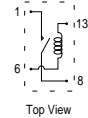
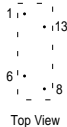

ORDERING INFORMATION

A complete part number is represented by the digits below. For example, the PRMA1A05 is a model 2 PRMA relay with a 1-Form A contact form, a nominal voltage of 5V and no extra options.

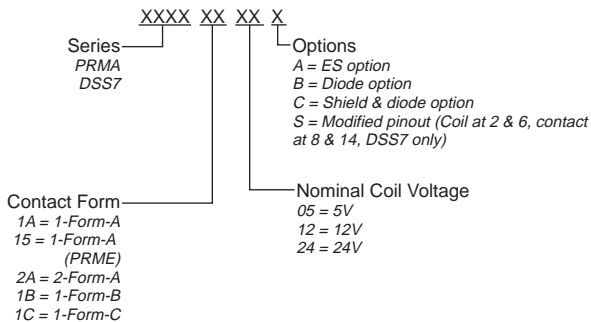

Ordering Information Special Schematics

PRME 25005
PRME 15005
PRME 15002
PRME 15003

PRMA 10037
PRMA 10038
PRMA 10039

*These represent
full part numbers.*



DESCRIPTION

This series uses the standard 16 pin DIP package. Options include 2-Form-C contacts, with 10W switching power. All relays are completely sealed and made of plastic material that conforms to UL94 flammability standard.

FEATURES

- 2-Form-C switching option
- Stable contact resistance over life
- 4000 Vac input-output isolation
- High insulation resistance
- Long life > 100 million operations
- FCC68 compatible

APPLICATIONS

- Industrial
- Signaling
- Metering

APPROVALS

- EN 60950 certified

RATINGS (@ 25° C)

Parameter	Min	Typ	Max	Unit
Switching Voltage			100	Volts
Switching Current			0.2	Amps
Carry Current			0.5	Amps
Switching Frequency			200	Hz
Contact Resistance			200	mΩ

(See detailed specifications for more information.)

DIP 16 SERIES REED RELAYS

LSR

SPECIFICATIONS

All parameters are at 25°C unless otherwise stated.
Operate voltage, release voltage, and coil resistance will change approximately 0.4%/°C as ambient temperature varies.

LSR
2-Form-C
Dry Reed

PARAMETER	CONDITIONS	SYMBOL	MIN	TYP	MAX	UNITS
Contact Ratings						
Switching Voltage	Max DC/PeakAC Resistive	V_L	-	-	100	Volts
Switching Current	Max DC/PeakAC Resistive	I_L	-	-	0.2	Amps
Carry Current	Max DC/PeakAC Resistive	I_C	-	-	0.5	Amps
Contact Rating	Max DC/PeakAC Resistive	-	-	-	3	Watts
Life Expectancy	Signal Level 1.0V 10mA Rated Loads ⁽¹⁾	-	50	100	-	x10 ⁶ Ops x10 ⁶ Ops
Static Contact Resistance	50mV, 10mA	CR	-	-	200	mΩ
Contact Material		-	-	Rh	-	-
Relay Specifications						
Insulation Resistance	Between all isolated pins at 100V, 25°C, 40% RH	IR	10 ⁹	-	-	Ω
Capacitance	Across Open Contacts	-	-	-	2.3	pf
	Open Contact to Coil	-	-	-	2.4	pf
Dielectric Strength	Between Contacts	-	200	-	-	VDC/Peak AC
	Contact to Coil	I/O	5600	-	-	VDC/Peak AC
Operate Time, including bounce	At Nominal Coil Voltage 10Hz Square Wave	T_{OP}	-	-	1	ms
Release Time	Zener-Diode Suppression	T_{REL}	-	-	1.5	ms
Environmental Ratings						
Storage Temperature		T_A	-30	-	+85	°C
Operating Temperature		T_O	-20	-	+70	°C
Soldering Temperature	Applied to pins, 5 sec. max.	-	-	-	+260	°C
Vibration Resistance (Survival)	10Hz - 500Hz	G	-	-	10	Gs
Shock Resistance (Survival)	11±1ms, 1/2 Sine Wave	S	-	-	30	Gs
Weight		-	-	4	-	grams

⁽¹⁾ Refer to life graphs

COIL SPECIFICATIONS

	Contact Form	Coil Voltage			Coil Resistance			Operate Voltage			Release Voltage			Nominal Input Power		
		Volts			Ω			Volts			Volts			mW		
Units																
Conditions					$\pm 10\%$, 25°C			Must operate by (25°C)			Must release by (25°C)					
Part #		Min	Typ	Max	Min	Typ	Max	Min	Typ	Max	Min	Typ	Max	Min	Typ	Max
LSR 2C05	2-Form-C		5	11	113	125	138			3.75	0.5				200	
LSR 2C12	2-Form-C		12	26	648	720	792			9	1				200	
LSR 2C24	2-Form-C		24	53	2592	2880	3168			18	2				200	

MECHANICAL DIMENSIONS

DIMENSIONS
mm
(inches)

LSR

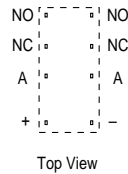
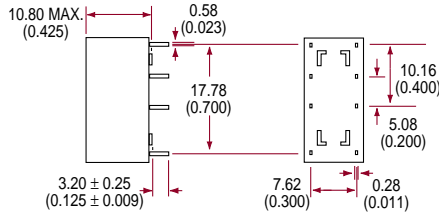
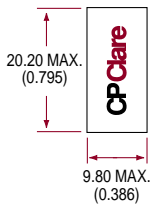

LSR Pinout

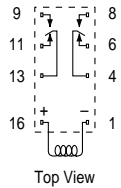

ORDERING INFORMATION

A complete part number is represented by the digits below.

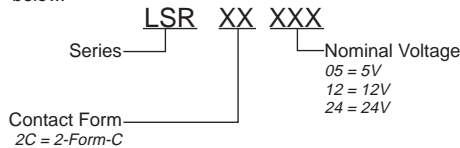

Security and Telecom Relays



DESCRIPTION

The MLR Series' efficient packaging offers the advantage of low input power with industry standard pin configurations. Models are available with 2500V input/output isolation for telecom and industrial applications where needed. A variety of contact materials are available to meet life and load requirements of the most demanding applications. The sputtered ruthenium contacts maintain low and stable contact resistance and are immune to the buildup of polymers that cause high contact resistance in rhodium plated or electromechanical armature style relays.

The MLR's low power coils are ideal for battery driven applications, such as security sensors. An effective magnetic shield protects the sensor from external source influence. Current sensing models are available to meet telecom line loop requirements such as off hook detection.

FEATURES

- High input-output isolation (4 KV available upon request)
- Small size (0.9" x 0.4")
- Low contact resistance (<150 mΩ)
- 10-watt contact rating
- Low coil resistance version available for Line Loop applications
- Magnetic shielding
- Available in 1-Form-A & 1-Form-C contact configurations
- High coil resistance versions available for low-power applications

APPROVALS

- EN60950 Certified (MLR10000 Series)

APPLICATIONS

- Telecom (off hook detection)
- Security (infrared sensors)
- General purpose

RATINGS (@ 25° C)

Parameter	Min	Typ	Max	Unit
Coil Input Power (some models)	-	25	-	mW
Switching Voltage (some models)	-	-	400	Volts
Contact/Coil Isolation (some models)	4000	-	-	Volts
Contact/Contact Isolation (some models)	-	-	800	Volts

(See detailed specifications for more information on some models.)

SPECIFICATIONS

MLR31C

1-Form-C
Standard

Ruthenium Contact

MLR41A

1-Form-A
DYAD®

Ruthenium Contact

All parameters are at 25°C unless otherwise stated.

PARAMETER	CONDITIONS	SYMBOL	MIN	TYP	MAX	MIN	TYP	MAX	UNITS
Contact Ratings									
Switching Voltage	Max DC/Peak Resistive	V_L	-	-	150	-	-	200	Volts
Switching Current	Max DC/Peak Resistive	I_L	-	-	0.25	-	-	0.5	Amps
Carry Current	Max DC/Peak Resistive	I_c	-	-	0.5	-	-	1	Amps
Contact Rating	Max DC/Peak Resistive	-	-	-	3	-	-	10	Watts
Life Expectancy	Signal Level 1.0V, 10mA	-	-	200	-	-	500	-	$\times 10^6$ Ops
	Rated Loads	-	5	-	-	10	-	-	$\times 10^6$ Ops
Static Contact Resistance	50mV, 10mA	CR	-	-	150	-	-	150	m Ω
Dynamic Contact Resistance	0.5V, 50mA at 100Hz, 1.5 msec	DCR	-	-	200	-	-	200	m Ω
Contact Material		-	-	Ru	-	-	Ru	-	-
Relay Specifications									
Insulation Resistance	Between all isolated pins at 100V, 25°C, 40%RH	IR	10^{10}	-	-	10^{10}	-	-	Ω
Capacitance Across Open Contacts	1 KHz Test Signal	-	-	1.5	-	-	0.8	-	pF
Dielectric Strength	Between Contacts	-	200	-	-	250	-	-	VDC/peak AC
	Contacts to Coil (Pin Option 1,4)	I/O	2500	-	-	2500	-	-	VDC/peak AC
Operate Time, including bounce	Contacts to Coil (Pin Option 2,3,5)	I/O	1500	-	-	1500	-	-	VDC/peak AC
	At Nominal coil voltage, 10Hz Square Wave	T_{OP}	-	1.0	-	-	0.7	-	ms
Release Time	Zener-Diode Suppression	T_{REL}	-	1.5	-	-	0.1	-	ms
Environmental Ratings									
Storage Temperature		T_A	-35	-	+100	-35	-	+100	°C
Operating Temperature		T_o	-20	-	+85	-20	-	+85	°C
Soldering Temperature	Applied to pin, 5 sec. max.	-	-	-	+250	-	-	+250	°C
Vibration Resistance	5Hz - 2000Hz	G	-	-	20	-	-	20	Gs
Shock Resistance	11 ± 1 ms, $\frac{1}{2}$ Sine Wave	S	-	-	50	-	-	50	Gs
Weight		-	-	12	-	-	12	-	grams
Relay Package									
				B			B		

Security and Telecom Relays

SPECIFICATIONS

MLR61A
1-Form-A
High Voltage
Ruthenium Contact

MLR100
1-Form-A
Current Sensing

All parameters are at 25°C unless otherwise stated.

PARAMETER	CONDITIONS	SYMBOL	MIN	TYP	MAX	MIN	TYP	MAX	UNITS
Contact Ratings									
Switching Voltage	Max DC/Peak Resistive	V_L	-	-	400	-	-	100	Volts
Switching Current	Max DC/Peak Resistive	I_L	-	-	0.5	-	-	0.5	Amps
Carry Current	Max DC/Peak Resistive	I_c	-	-	1	-	-	1	Amps
Contact Rating	Max DC/Peak Resistive	-	-	-	10	-	-	10	Watts
Life Expectancy	Signal Level 1.0V, 10mA Rated Loads	-	-	500 5	-	-	200 1	-	$\times 10^6$ Ops $\times 10^6$ Ops
Static Contact Resistance	50mV, 10mA	CR	-	-	150	-	-	150	m Ω
Dynamic Contact Resistance	0.5V, 50mA at 100Hz, 1.5 msec	DCR	-	-	200	-	-	200	m Ω
Contact Material		-	-	Ru	-	-	Ru	-	-
Relay Specifications									
Insulation Resistance	Between all isolated pins at 100V, 25°C, 40%RH	IR	10^{10}	-	-	10^{10}	-	-	Ω
Capacitance Across Open Contacts	1 KHz Test Signal	-	-	0.8	-	-	0.8	-	pF
Dielectric Strength	Between Contacts	-	800	-	-	150 ⁽¹⁾	-	-	VDC/peak AC
	Contacts to Coil (Pin Option 1,4) Contacts to Coil (Pin Option 2,3,5)	I/O I/O	2500 1500	-	-	4000 1500 ⁽²⁾	-	-	VDC/peak AC VDC/peak AC
Operate Time, including bounce	At Nominal coil voltage, 10Hz Square Wave	T_{OP}	-	0.6	-	-	1.0	-	ms
Release Time	Zener-Diode Suppression	T_{REL}	-	0.25	-	-	0.1	-	ms
Environmental Ratings									
Storage Temperature		T_A	-35	-	+100	-35	-	+100	°C
Operating Temperature		T_O	-20	-	+85	-20	-	+85	°C
Soldering Temperature	Applied to pin, 5 sec. max.	-	-	-	+250	-	-	+250	°C
Vibration Resistance	5Hz - 2000Hz or 10Hz - 500Hz	G	-	-	20	-	-	20	Gs
Shock Resistance	11 ± 1 ms, 1/2 Sine Wave	S	-	-	50	-	-	50	Gs
Weight		-	-	12	-	-	12	-	grams
Relay Package				B			A		

⁽¹⁾ Model MLR10001 is 230V minimum

⁽²⁾ Model MLR 10001 is 2000V

COIL SPECIFICATIONS

	Coil Voltage			Coil Resistance			Operate Voltage			Release Voltage			Pin Options ⁽¹⁾
Units	Volts			Ω			Volts			Volts			
Conditions				$\pm 10\%$ (25°C)			Must operate by (25°C)			Must release by (25°C)			
Part #	Min	Typ	Max	Min	Typ	Max	Min	Typ	Max	Min	Typ	Max	
MLR31C05X		5	8	675	750	825			3.6	0.4			4,5
MLR31C12X		12	16	3150	3500	3850			9.0	1.0			
MLR31C24X		24	30	7650	8500	9350			18	2.0			
MLR41A05X		5	8	900	1000	1100			3.6	0.4			1,2,3
MLR41A12X		12	16	3150	3500	3850			9.0	1.0			
MLR41A24X		24	30	7650	8500	9350			18	2.0			
MLR61A05X		5	8	675	750	825			3.6	0.4			1,2,3
MLR61A12X		12	16	3150	3500	3850			9.0	1.0			
MLR61A24X		24	30	7650	8500	9350			18	2.0			

⁽¹⁾ For schematic options, please refer to drawings on next page.

CURRENT SENSING RELAYS

	Nominal Coil Current			Coil Resistance			Operate Current			Release Current			Pin Options ⁽¹⁾
Units	Milliamps			Ω			Milliamps			Milliamps			
Conditions	25°C			25°C			Must operate by (25°C)			Must release by (25°C)			
Part #	Min	Typ	Max	Min	Typ	Max	Min	Typ	Max	Min	Typ	Max	
MLR10001		22	230	9	10	11			15	5			2
MLR10002		22	230	9	10	11			15	5			2
MLR10003		22	230	16.2	18	19.8			15	5			1
MLR10004		13	170	16.2	18	19.8			9	2.55			2
MLR10005		22	170	9	10	11			15	5			1

⁽¹⁾ For schematics, please refer to drawings on next page.

MECHANICAL DIMENSIONS

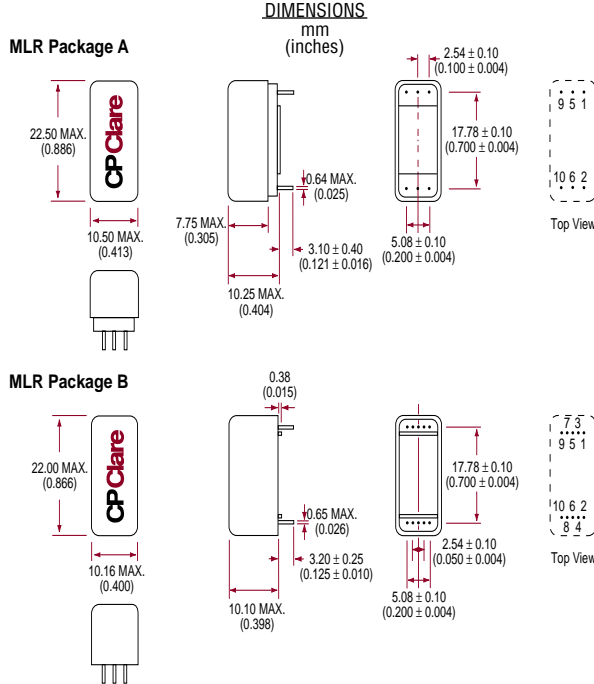

SCHEMATIC OPTIONS

MLR Schematic Option 1

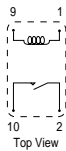

MLR Schematic Option 2

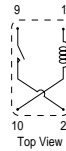

MLR Schematic Option 3



MLR Schematic Option 4

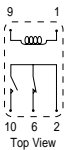

MLR Schematic Option 5

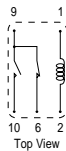

ORDERING INFORMATION

A complete part number is represented by the digits below. For example, MLR31C055 is a model 3 MLR series relay with 1-Form-C contacts, 5V coil voltage, & pin option "5" (see schematic drawings).

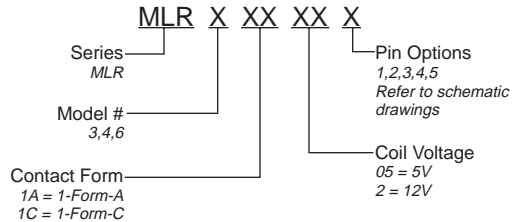

CURRENT SENSING RELAYS





DESCRIPTION

The MRBS is a non-polarity sensitive device with a high sensitivity version for direct coupling to TTL and CMOS outputs without auxiliary relay drivers. This is due to low input power requirements (10mW) while maintaining the high isolation and low contact resistance features of the Clare DYAD®. The MRBS has a sealed package for automatic board processing.

Alternate low resistance single and dual coil versions are designed for telecommunication applications sensing off-hook conditions without loading the line or causing distortion of the line balance condition.

FEATURES

- High isolation
- Electromagnetic shielding
- Fully encapsulated assembly to meet power, size and assembly requirements
- Reduced input power
- FCC68 compatible

APPLICATIONS

- Telecommunications
- Battery powered
- Current sensing

AGENCY APPROVALS

- EN 60950 certified

RATINGS (@ 25° C)

Parameter	Min	Typ	Max	Unit
Switching Voltage			200	Volts
Switching Current			0.5	Amps
Carry Current			1	Amps
Switching Frequency			500	Hz
Contact Resistance			200	mΩ

(See detailed specifications for more information.)

MRBS SERIES REED RELAYS

MRBS ■ MRBS2

SPECIFICATIONS

PARAMETER	CONDITIONS	SYMBOL	MRBS			MRBS2			UNITS
			MIN	TYP	MAX	Current Sensing 1-Form-A			
All parameters are at 25°C unless otherwise stated.									
Contact Ratings									
Switching Voltage	Max DC/Peak AC Resistive	V _L	-	-	200	-	-	75	Volts
Switching Current	Max DC/Peak AC Resistive	I _L	-	-	0.5	-	-	0.15	Amps
Carry Current	Max DC/Peak AC Resistive	I _c	-	-	1	-	-	1	Amps
Contact Rating	Max DC/Peak AC Resistive	-	-	-	10	-	-	5	Watts
Life Expectancy	Signal Level 1.0V, 10mA Rated Loads ⁽¹⁾	-	-	100	-	-	100	-	x10 ⁶ Ops
Static Contact Resistance	50mV, 10mA	CR	-	-	200	-	-	200	mΩ
Contact Material		-	-	Ru	-	-	Ru	-	-
Relay Specifications									
Insulation Resistance	Between all isolated pins at 100V, 25°C, 40%RH	IR	10 ¹⁰	-	-	10 ¹⁰	-	-	Ω
Capacitance	Across Open Contacts	-	-	0.6	2	-	0.6	2	pF
	Open Contact to Coil	-	-	2.5	5	-	2.5	5	pF
	Closed Contact to Coil	-	-	4.5	6.5	-	4.5	6.5	pF
Dielectric Strength	Between Contacts	I/O	250	-	-	210	-	-	VDC/peak AC
	Contacts to Coil	I/O	1400	-	-	1400 ⁽²⁾	-	-	VDC/peak AC
Operate Time (MRBS including bounce)	At Nominal coil voltage, 10Hz Square Wave	T _{OP}	-	1.3	2	-	1.3	2	ms
Release Time	Zener-Diode Suppression	T _{REL}	-	1	1.5	-	1	1.5	ms
Environmental Ratings									
Storage Temperature		T _A	-20	-	+85	-20	-	+85	°C
Operating Temperature		T _O	-20	-	+70	-20	-	+70	°C
Soldering Temperature	Applied to pins, 5 sec. max.	-	-	-	+260	-	-	+260	°C
Vibration Resistance (Survival)	5Hz to 2000Hz	G	-	-	10	-	-	10	Gs
Shock Resistance (Survival)	11±1ms, 1/2 Sine Wave	S	-	-	50	-	-	50	Gs
Weight		-	-	11	-	-	11	-	grams

⁽¹⁾ Consult factory for life requirements

⁽²⁾ Model MRBS20012 is rated at 4000V_{RMS}

COIL SPECIFICATIONS (MRBS)

Units	Coil Voltage			Coil Resistance			Operate Voltage			Release Voltage			Schematic
	Volts			Ω			Volts			Volts			
				±10%, 25°C			Must operate by 25°C			Must release by 25°C			
Part #	Min	Typ	Max	Min	Typ	Max	Min	Typ	Max	Min	Typ	Max	
MRBS001A204		4	14	1305	1450	1595			3	0.3			1
MRBS001A205		5	17	2520	2800	3080			3.8	0.5			1
MRBS001A212		12	36	9900	11,000	12,100			9	1			1

Note: Operate voltage, release voltage, and coil resistance will change by 0.4%/°C as ambient temperature varies.

COIL SPECIFICATIONS (MRBS2)

Part #	Coil Current			Coil Resistance			Operate Current			Release Current			Schematic
	mA			Ω			mA			mA			
	Min	Typ	Max	Min	Typ	Max	Min	Typ	Max	Min	Typ	Max	
MRBS20001			200	16.2	18	19.8			15	2.5			2
MRBS20003			125	41.4	46	50.6			8	0.8			2
MRBS20010			200	14.4	16	17.6			15	2.5			2
MRBS20031			200	11.7	13	14.3			15	2.5			2
MRBS20043			265	9	10	11			15	2.5			2
MRBS20002 L1			200	8.1	9	9.9			15	2.5			3
MRBS20002 L2			200	8.1	9	9.9							3
MRBS20037 L1			235	5.85	6.5	7.15			15	2.5			3
MRBS20037 L2			235	5.85	6.5	7.15							3
MRBS20046 L1			270	4.5	5	5.5			15	2.5			3
MRBS20046 L2			270	4.5	5	5.5							3
MRBS20012			200	16.2	18	19.8			15	2.5			3

MRBS 20002, 20037, and 20046 operate values are specified with 2 coils wired in series, magnetically aiding.

MRBS Schematics

MRBS

Schematic 1



Top View

MRBS

Schematic 2



Top View

MRBS

Schematic 3



Top View

MRBS

Schematic 4



Top View

MECHANICAL DIMENSIONS

DIMENSIONS

mm
(inches)

MRBS 1A

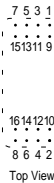
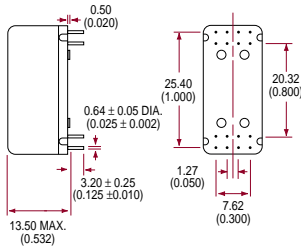
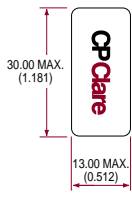

Top View

ORDERING INFORMATION

MRBS

A complete part number is represented by the digits below.

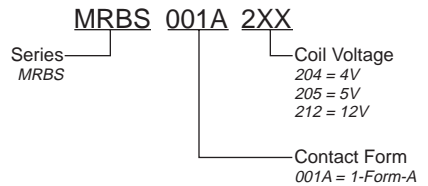

MRBS2

Full part numbers are listed in the coil specification chart above.

Special Applications



DESCRIPTION

The MRF series represents the smallest surface mount relay in the world. Designed to dramatically reduce board space requirements, the MRF series uses less than 50 mm² of PCB area. The MRF8 was specifically designed for passing high frequency signals. Its small size reduces the switch-to-shield capacitance, enabling the relay to pass frequencies approaching 3 GHz with minimal distortion and insertion loss. In addition, the small size makes it ideal for fast digital pulse applications in which minimal rise times through the relay are necessary.

The MRF series was developed using a new patent pending process that ensures long lasting (200 million operations at signal level) and reliable operation after undergoing the stress of IR reflow or vapor phase processes. The relays are available in the standard lead configuration, J-bend, gull and axial; they can also be ordered on tape and reel for automatic insertion equipment.

FEATURES

- Surface mount relay
- Ability to pass 3 GHz
- Rise time <50 psec.
- 50Ω characteristic impedance
- Fast digital pulse application
- Gull or "J" lead available
- Patent pending design
- Compatible with IR & vapor phase soldering
- Low profile
- Low capacitance

APPLICATIONS

- IC testers
- Mixed signal testers
- High-frequency communication
- High bandpass feedback applications
- Telecom
- Security

RATINGS (@ 25° C)

Parameter	Min	Typ	Max	Unit
Switching Voltage			100	Volts
Carry Current			0.5	Amps
Switching Current			0.25	Amps
Contact Rating			3.0	Watts

(See detailed specifications for more information.)

SPECIFICATIONS

All parameters are at 25°C unless otherwise stated.
Operate voltage, release voltage, and coil resistance
will change by 0.4%/°C as ambient temperature varies.

MRF4
1-Form-A

MRF 8
1-Form-A
Coaxial shield
High Frequency

PARAMETER	CONDITIONS	SYMBOL	MIN	TYP	MAX	MIN	TYP	MAX	UNITS
Contact Ratings									
Switching Voltage	Max DC/PeakAC Resistive	V_L	-	-	100	-	-	100	Volts
Switching Current	Max DC/PeakAC Resistive	I_L	-	-	0.25	-	-	0.25	Amps
Carry Current	Max DC/PeakAC Resistive	I_C	-	-	0.5	-	-	0.5	Amps
Contact Rating	Max DC/PeakAC Resistive	-	-	-	3	-	-	3	Watts
Life Expectancy	Signal Level 1.0 V 10mA	-	-	200	-	-	200	-	$\times 10^6$ Ops
	Rated Loads (consult factory)	-	-	-	-	-	-	-	$\times 10^6$ Ops
Static Contact Resistance	50mV, 10mA	CR	-	-	150	-	-	150	m Ω
Dynamic Contact Resistance	.5V, 50mA at 100Hz, after 1.5 msec	DCR	-	-	200	-	-	200	m Ω
Contact Material		-	-	Ru	-	-	Ru	-	-
Relay Specifications									
Insulation Resistance	Between all isolated pins at 100V, 25°C, 40% RH	IR	10^{11}	10^{13}	-	10^{11}	10^{13}	-	Ω
Capacitance	Across Open Contacts	-	-	0.2	-	-	0.2	-	pF
	Open Contact to Coil/Sheild	-	-	1	-	-	0.8	1	pF
Dielectric Strength	Between Contacts	-	150	-	-	150	-	-	VDC/Peak AC
	Contacts to Shield	-	N/A	-	-	150	-	-	VDC/Peak AC
	Contacts/Shield to Coil	-	1000	-	-	500	-	-	VDC/Peak AC
Operate Time, including bounce	At Nominal Coil Voltage 10Hz Square Wave	T_{OP}	-	200	-	-	200	-	ms
Release Time	Zener-Diode Suppression	T_{REL}	-	50	-	-	50	-	ms
Environmental Ratings									
Storage Temperature		T_A	-55	-	+100	-55	-	+100	°C
Operating Temperature		T_O	-40	-	+85	-40	-	+85	°C
Soldering Temperature ⁽¹⁾		-	-	-	+265	-	-	+265	°C
Vibration Resistance	10Hz - 5Hz Reed = 5Hz - 2000Hz	G	-	-	20	-	-	20	Gs
Shock Resistance	11±1ms, 1/2 Sine Wave	S	-	-	50	-	-	50	Gs
Weight		-	-	0.7	-	-	0.7	-	grams

(1) Can withstand up to a one minute immersion in a surface mount soldering process.

PERFORMANCE GRAPHS

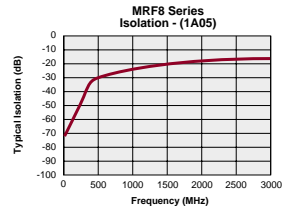
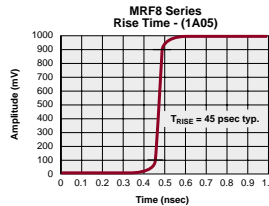
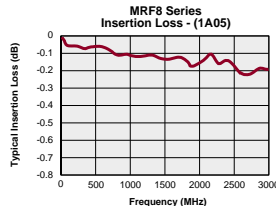
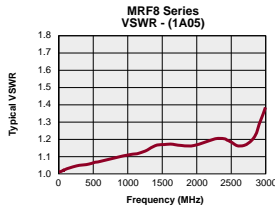

Special Applications

DIMENSIONS
mm
(inches)

MECHANICAL DIMENSIONS

MRF4 J Lead
(Lead Option -02)

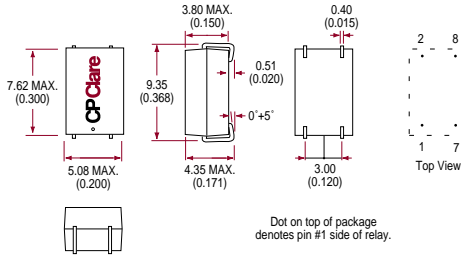

MRF4 J Lead
(Lead Option -22)

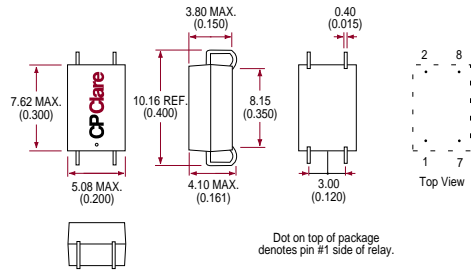

MRF4 Gull Wing
(Lead Option -01)

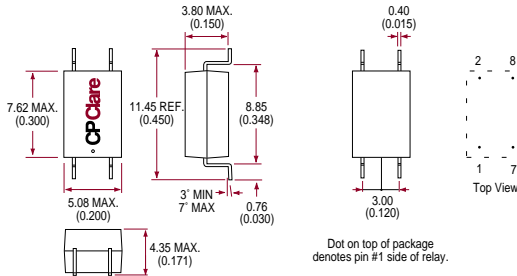

MRF4

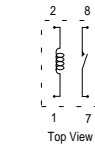

MRF8 J Lead
(Lead Option -02)

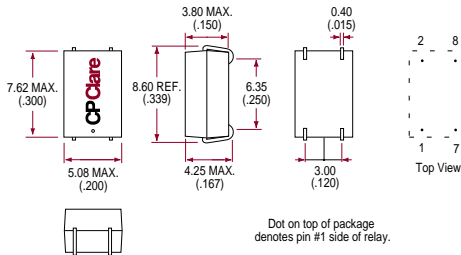

MRF8 J Lead
(Lead Option -22)

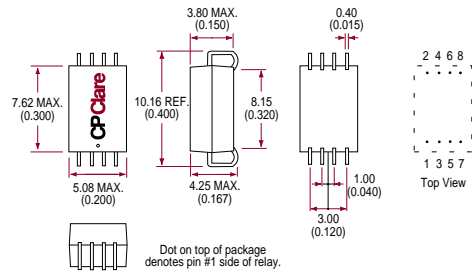

MRF8

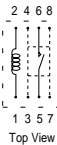

MRF8 Gull Wing
(Lead Option -01)

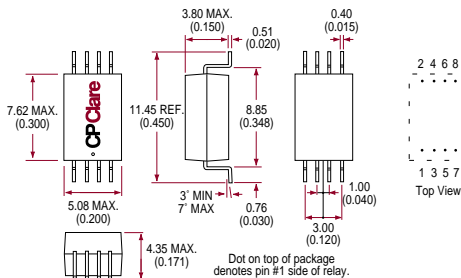

MRF8 Gull Wing
(Lead Option -01)

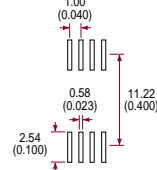

MRF8 J Lead
(Lead Option -22)

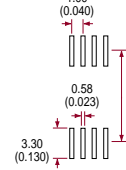

MRF8 J Lead
(Lead Option -02)

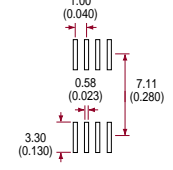

SPECIFICATIONS

COIL SPECIFICATIONS

	Coil Voltage			Coil Resistance			Operate Voltage			Release Voltage		
Units	Volts			Ω			Volts			Volts		
Conditions				±10% (25°C)			Must operate by (25°C)			Must release by (25°C)		
Part #	Min	Typ	Max	Min	Typ	Max	Min	Typ	Max	Min	Typ	Max
MRF41A05XXX		5	7	157	175	193			3.75	0.4		
MRF81A05XXX		5	7	157	175	193			3.75	0.4		

ORDERING INFORMATION

A complete part number is represented by the digits below. For example, MRF41A05 is a model 4 MRF relay with a contact form of 1A and coil voltage of 5V.

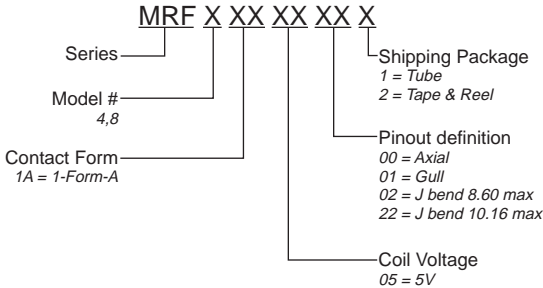

SIL4 ■ DSS4



DESCRIPTION

CP Clare offers a large selection of molded SIP relays to meet customer applications. The DSS4 was developed several years ago and continues to be the relay of choice for hook switch applications in modems and general purpose applications. The SIL4 is the first of a series of new molded products ideally suited for use in high reliability requirements. Its design centers on a new patent pending process aimed at protecting the hermetically sealed reed switch. When properly protected, the reed switch outperforms most other electromechanical switching devices for operating life (at low signal levels), isolation, low resistance and low operating power.

FEATURES

- Patent pending process (SIL4)
- High reliability switching
- 3V operate option available (SIL4)
- Quality defect levels <50 PPM (SIL4)
- Long operating life at low levels (>1 billion operations)
- Capable of switching up to 200V
- High isolation between input and output (2500V)
- Optional internal diode
- High density board mounting
- Automatic insertion design
- State-of-the-art capsule designs
- Epoxy molded single-in-line package

AGENCY APPROVALS

- UL recognized DSS4 model

APPLICATIONS

- ATE
- Functional board testers
- Integrated circuit testers
- Bare board testers
- Telecom
- Matrix requirements
- Instrumentation
- Data acquisition

RATINGS (@ 25° C)

Parameter	Min	Typ	Max	Unit
Switching voltage SIL4/DSS4			200	Volts
Switching current SIL4/DSS4			0.5	Amps
Carry current SIL4			1.5	Amps
DSS4			2	Amps
Switching frequency SIL4/DSS4			500	Hz
Contact resistance SIL4			120	mΩ

(See detailed specifications for more information.)

SPECIFICATIONS

Dry Reed Relay Specifications

All parameters at 25°C unless otherwise stated.
Operate voltage, release voltage, and coil resistance will vary by approximately 0.4%/°C as ambient temperature varies.

SIL4
Instrument-Grade

DSS4
General Purpose

PARAMETER	CONDITIONS	SYMBOL	MIN	TYP	MAX	MIN	TYP	MAX	UNITS
Contact Ratings									
Switching Voltage	Max DC/PeakAC Resistive	V_L	-	-	200	-	-	200	Volts
Switching Current	Max DC/PeakAC Resistive	I_L	-	-	0.5	-	-	0.5	Amps
Carry Current	Max DC/PeakAC Resistive	I_C	-	-	2	-	-	2	Amps
Contact Rating	Max DC/PeakAC Resistive	-	-	-	10	-	-	10	Watts
Life Expectancy	Signal Level 1.0V 10mA Rated Loads ⁽¹⁾	-	-	1000	-	-	500	-	x10 ⁶ Ops x10 ⁶ Ops
Static Contact Resistance	50mV, 10mA	CR	-	95	120	-	-	150	mΩ
Dynamic Contact Resistance	0.5V, 50mA at 100Hz, 1.5 msec	DCR	-	-	150	-	N/A	N/A	mΩ
Contact Material		-	-	Ru	-	-	Ru	-	-
Relay Specifications									
Insulation Resistance	Between all isolated pins at 100V, 25°C, 40% RH	IR	10 ¹²	10 ¹³	-	10 ¹⁰	10 ¹²	-	Ω
Capacitance	Across Open Contacts	-	-	-	0.8	-	-	1	pF
Open Contact to Coil		-	-	1.2	-	-	-	2	pF
Dielectric Strength	Between Contacts	I/O	250	-	-	250	-	-	VDC/Peak AC VDC/Peak AC
	Contacts to Coil	I/O	2500	-	-	1500	-	-	
Operate Time, including bounce	At Nominal Coil Voltage 10Hz Square Wave	T ^{OP}	-	0.2	0.5	-	0.25	0.5	ms
Release Time	Zener-Diode Suppression	T _{REL}	-	0.1	0.5	-	0.15	0.5	-
Environmental Ratings									
Storage Temperature		T _A	-55	-	+125	-40	-	+105	°C
Operating Temperature		T _O	-40	-	+85	-40	-	+85	°C
Soldering Temperature	Applied to pins, 10 sec. max.	-	-	-	+260 ⁽²⁾	-	-	+260	°C
Vibration Resistance ⁽³⁾ (Survival)	5Hz - 2000Hz	G	-	-	20	-	-	20	Gs
Shock Resistance (Survival)	11±1ms, 1/2 Sine Wave	S	-	-	100	-	-	-	-
Weight		-	-	1.8	-	-	1.6	-	grams

⁽¹⁾ Refer to life graphs

⁽²⁾ Capable of surviving infrared solder-reflow process

⁽³⁾ Use caution not to exceed vibration resistance limits while ultrasonically cleaning relays with DYAD switches.
Contact CP Clare Engineering for more details/ recommendations

COIL SPECIFICATIONS

	Contact Form	Coil Voltage			Coil Resistance			Operate Voltage			Release Voltage			Nominal Input Power		
Units		Volts			Ω			Volts			Volts			mW		
Conditions					±10% (25°C)			Must operate by (25°C)			Must release by (25°C)					
Part #		Min	Typ	Max	Min	Typ	Max	Min	Typ	Max	Min	Typ	Max	Min	Typ	Max
SIL41A03(B)	1-Form-A		3	6	135	150	165			2.25	0.3					60
SIL41A05(B)	1-Form-A		5	10	450	500	550			3.75	0.4					50
SIL41A12(B)	1-Form-A		12	16	900	1000	1100			8.6	1.5					144
SIL41A24(B)	1-Form-A		24	30	1800	2000	2200			17.5	2.5					288
SIL41B05(B)	1-Form-B		5	6	450	500	550			3.75	0.8					50
SIL41B12(B)	1-Form-B		12	14	900	1000	1100			9	1.5					144
SIL41B24(B)	1-Form-B		24	29	1800	2000	2200			18	2.5					288
DSS41A05	1-Form-A		5	10	450	500	550			3.75	0.8					50
DSS41A12	1-Form-A		12	16	900	1000	1100			8.6	1.5					144
DSS41A24	1-Form-A		24	30	1800	2000	2200			17.5	2.5					288
DSS41B05	1-Form-B		5	10	450	500	550			3.75	0.8					50
DSS41B12	1-Form-B		12	16	900	1000	1100			9	1					144
DSS41B24	1-Form-B		24	30	1935	2150	2365			18	2					268

MECHANICAL DIMENSIONS

DIMENSIONS
mm
(inches)

SIL4/DSS4

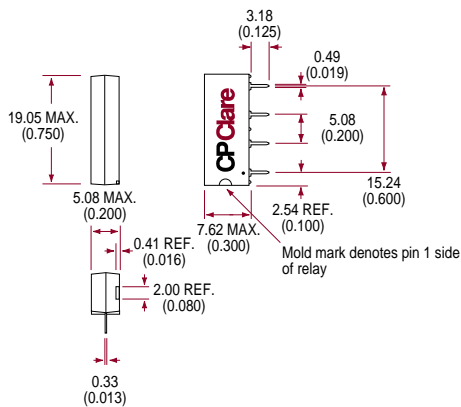

SIL4/DSS4 Pinout

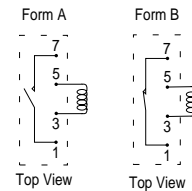

For Form B or diode options, coil polarity (pin #3 positive) must be observed.

PERFORMANCE GRAPHS

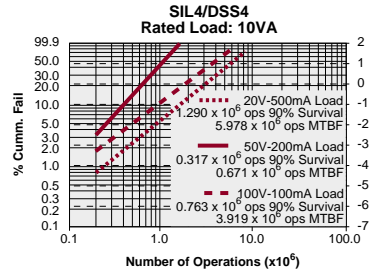
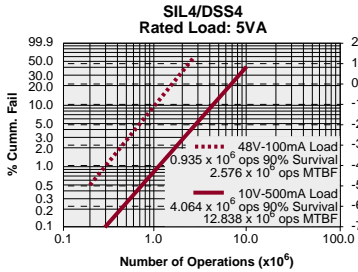

Relay Internal Temperature Rise vs. Power

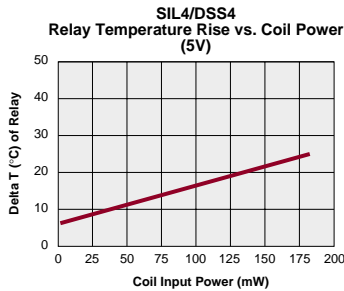

PERFORMANCE GRAPHS

Operate/Release Time Characteristics

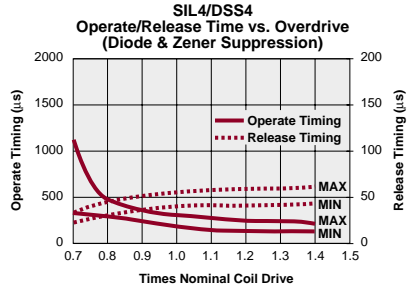
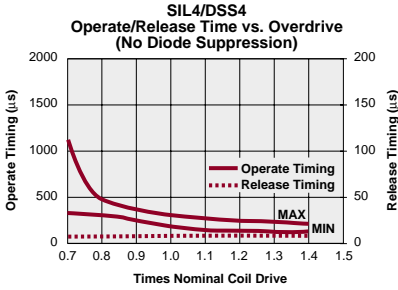
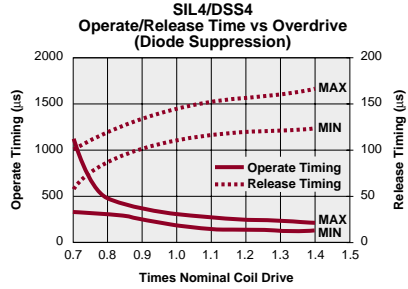
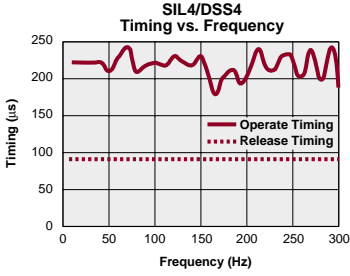

MAGNETIC INTERFERENCE

If relays are inserted in close proximity, the pickup and dropout voltages will be affected by the magnetic flux produced when the coils are energized.

In general, worst-case magnetic interaction conditions for pull-in voltage in a matrix exist when all relay fields have the same polarity and all of the fields are from adjacent relays (See figure).

The direction of the parameter shift is determined by whether the stray flux aids or bucks the flux produced by the coil of the relay under consideration.

To calculate the change in pull-in voltage and dropout voltage, multiply the percent change shown by the relay's nominal voltage. For example, if the percent change in pull-in voltage is 14% for a 5V nominal relay, the pull-in voltage will increase by 0.7 volts.

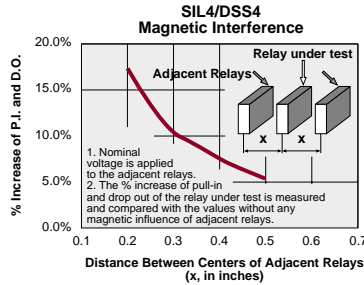

ORDERING INFORMATION

A complete part number is represented by the digits below.

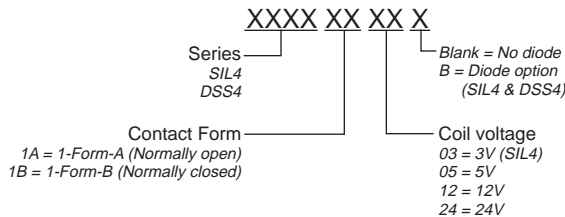

SMR SERIES REED RELAYS

SMR4 ■ SMR6



DESCRIPTION

The SMR series is the first of a new group of surface mount relays that were developed using a patent pending process. The internal design ensures the hermeticity of the reed switch and viability of all internal connections when exposed to the thermal stresses of IR reflow and vapor phase processes.

The SMR4 is a low profile package that is ideally suited for telecom, instrumentation and PCB test applications. The SMR6 was developed for high frequency applications and contains a coaxial shield for 50Ω impedance line matching. Low capacitance across the contacts and from contact to coil allows the relay to pass signals ranging from DC to 1.5 GHz. Both packages are available in either axial, gull or J-bend lead configurations. Tape and reel packaging is also available for automatic pick and place equipment.

FEATURES

- Surface mount relay
- Coaxial shield
- RF transmission up to 1.5 GHz
- Fast digital pulse applications
- Contacts hermetically sealed
- Gull or “J” leads
- Patent pending design
- Compatible with IR & vapor phase soldering
- Low capacitance
- Low profile
- Tape & reel option

APPLICATIONS

- IC testing
- Signal testing
- High frequency communications
- High frequency scanners
- Function PCB testers
- Medical electronics
- Telecom

RATINGS (@ 25° C)

Parameter	Min	Typ	Max	Units
Switching Voltage			200	Volts
Switching Current			0.5	Amps
Carry Current			1.5	Amps
Switching Frequency			500	HZ
Contact Resistance			150	mW

(See detailed specifications for more information.)

SPECIFICATIONS

All parameters are at 25°C unless otherwise stated.

Note: Operate voltage, release voltage, and coil resistance will vary by 0.4%/°C as ambient temperature varies.

SMR4
1-Form-A

SMR6
1-Form-A
Coaxial Shield

PARAMETER	CONDITIONS	SYMBOL	MIN	TYP	MAX	MIN	TYP	MAX	UNITS
Contact Ratings									
Switching Voltage	Max DC/Peak AC Resistive	V_L	-	-	200	-	-	200	Volts
Switching Current	Max DC/Peak AC Resistive	I_L	-	-	0.5	-	-	0.5	Amps
Carry Current	Max DC/Peak AC Resistive	I_c	-	-	1.5	-	-	1.5	Amps
Contact Rating	Max DC/Peak AC Resistive	-	-	-	10	-	-	10	Watts
Life Expectancy	Signal Level 1.0V, 10mA	-	-	1000	-	-	1000	-	$\times 10^6$ Ops
	Rated Loads	-	-	5	-	-	5	-	$\times 10^6$ Ops
Static Contact Resistance	50mV, 10mA	CR	-	-	150	-	-	150	m Ω
Dynamic Contact Resistance	0.5V, 50mA at 100Hz, 1.5msec	DCR	-	-	200	-	-	200	m Ω
Contact Material		-	-	Ru	-	-	Ru	-	-
Relay Specifications									
Insulation Resistance	Between all isolated pins at 100V, 25°C, 40%RH	IR	10^{11}	10^{13}	-	10^{11}	10^{13}	-	Ω
Capacitance	Across Open Contacts	-	-	0.8	-	-	0.8	-	pF
	Open Contact to Coil/Shield	-	-	1.5	-	-	1.5	-	pF
Dielectric Strength	Between Contacts	-	250	-	-	250	-	-	VDC/peak AC
	Contacts to Shield	-	-	N/A	-	750	-	-	VDC/peak AC
	Contacts to Coil	I/O	1500	-	-	750	-	-	VDC/peak AC
Operate Time, including bounce	At Nominal coil voltage, 10Hz Square Wave	T_{OP}	-	0.5	-	-	0.5	-	ms
Release Time	Zener-Diode Suppression	T_{REL}	-	0.1	-	-	0.1	-	ms
Environmental Ratings									
Storage Temperature		T_A	-55	-	+100	-55	-	+100	°C
Operating Temperature		T_o	-20	-	+85	-20	-	+85	°C
Soldering Temperature ⁽¹⁾		-	-	-	+265	-	-	+265	°C
Vibration Resistance	5Hz - 2000Hz	G	-	-	20	-	-	20	Gs
Shock Resistance	11±1ms, 1/2 Sine Wave	S	-	-	50	-	-	50	Gs
Weight		-	-	1.3	-	-	1.3	-	grams

⁽¹⁾ Can withstand a one minute immersion in a surface mount soldering process.

COIL SPECIFICATIONS

Part #	Coil Voltage			Coil Resistance			Operate Voltage			Release Voltage		
	Volts			Ω			Volts			Volts		
				±10% (25°C)			Must operate by (25°C)			Must release by (25°C)		
Conditions	Min	Typ	Max	Min	Typ	Max	Min	Typ	Max	Min	Typ	Max
SMR41A05xx		5	7	225	250	275	0.8		3.75	0.4		3.5
SMR41A12xx		12	16	585	650	715	2		8.6	1.5		8
SMR61A05xx		5	7	180	200	220	0.8		3.75	0.4		3.5
SMR61A12xx		12	16	585	650	715	2		8.6	1.5		8

MECHANICAL DIMENSIONS

DIMENSIONS
mm
(inches)

SMR4 - Gull Wing

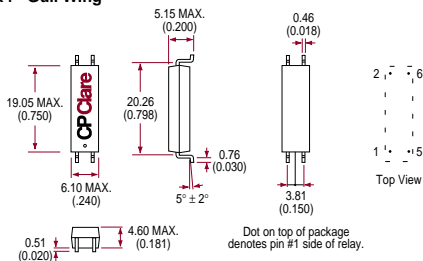

SMR6 - J

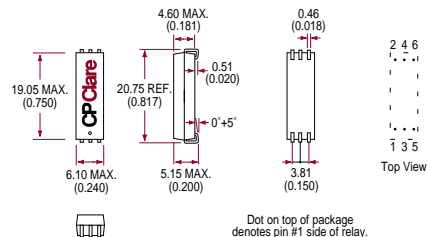

SMR6 - Gull Wing

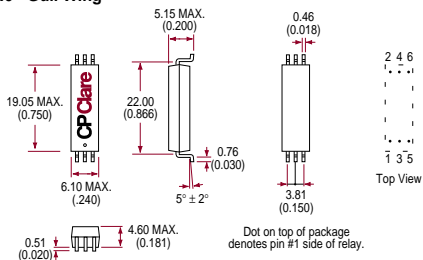

SMR6 - J

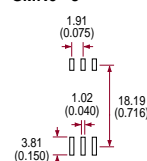

SMR6 - Gull Wing

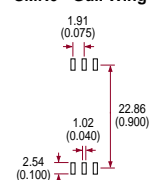

SMR6 - J

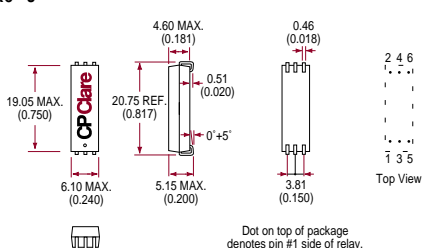

ORDERING INFORMATION

A complete part number is represented by the digits below.

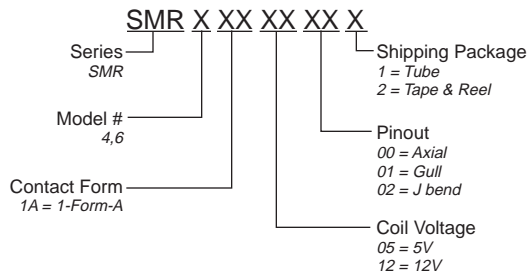



DESCRIPTION

CP Clare's TFT series features an industry standard pin configuration that gives optimum isolation between input and output. Seven standard models give the designer a wide range of choices in switching power, contact material, contact form and pin configuration. In addition, modular construction allows for easy adaptation to meet engineers' custom requirements.

FEATURES

- Available in several different switching options
- Available in magnetically shielded metal case
- Available in 0.2" x 0.4" x 0.2" & 0.3" x 0.4" x 0.3" other single in-line footprint options available
- Hermetically sealed contacts
- No minimum switching voltage or current
- Low on resistance

APPLICATIONS

- Telecom
- Security
- General purpose

AGENCY APPROVALS

- UL recognized
- CSA approved

RATINGS (@ 25° C)

Parameter		Unit
Switching Voltage	up to 500	Volts
Switching Current	up to 1	Amps
Input/Output Isolation	min 2500	VAC

(See detailed specifications for more information.)

TFT SERIES REED RELAYS

General Purpose SIL Relay

SPECIFICATIONS

TFT31CXXXX

1-Form-C
Standard
Ruthenium Contact

TFT41AXXXX

1-Form-A
DYAD®
Ruthenium Contact

All parameters are at 25°C unless otherwise stated.

PARAMETER	CONDITIONS	SYMBOL	MIN	TYP	MAX	MIN	TYP	MAX	UNITS
Contact Ratings									
Switching Voltage	Max DC/PeakAC Resistive	V_L	-	-	150	-	-	200	Volts
Switching Current	Max DC/PeakAC Resistive	I_L	-	-	0.25	-	-	0.5	Amps
Carry Current	Max DC/PeakAC Resistive	I_c	-	-	0.5	-	-	1	Amps
Contact Rating	Max DC/PeakAC Resistive	-	-	-	3	-	-	10	Watts
Life Expectancy	Signal Level 1.0V, 10mA Rated Loads	-	-	200 5	-	-	500 10	-	x10 ⁶ Ops x10 ⁶ Ops
Static Contact Resistance	50mV, 10mA	CR	-	-	150	-	-	150	mΩ
Dynamic Contact Resistance	0.5V, 50mA at 100Hz, 1.5 msec	DCR	-	-	200	-	-	200	mΩ
Contact Material		-	-	Ru	-	-	Ru	-	-
Relay Specifications									
Insulation Resistance	Between all isolated pins at 100V, 25°C, 40%RH	IR	10 ¹⁰	-	-	10 ¹⁰	-	-	Ω
Capacitance Across Open Contacts	1 KHz Test Signal	-	-	2.3	-	-	1.0	-	pF
Contact to Coil	1 KHz Test Signal	-	-	4.75	-	-	4	-	pF
Dielectric Strength	Between Contacts	-	200	-	-	250	-	-	VDC/peak AC
	Contacts to Coil	I/O	2500	-	-	2500	-	-	VDC/peak AC
Operate Time, including bounce	At Nominal coil voltage, 30Hz Square Wave	T_{OP}	-	0.5	-	-	0.5	-	msec.
Release Time	Zener-Diode Suppression	T_{REL}	-	0.25	-	-	0.1	-	msec.
Environmental Ratings									
Storage Temperature		T_A	-35	-	+100	-35	-	+100	°C
Operating Temperature		T_O	-20	-	+85	-20	-	+85	°C
Soldering Temperature	Applied to pins, 5 sec. max.	-	-	-	+260	-	-	+260	°C
Vibration Resistance	1Hz - 2000Hz	G	-	-	20	-	-	20	Gs
Shock Resistance	11±1ms, 1/2 Sine Wave	S	-	-	50	-	-	50	Gs
Weight		-	-	9	-	-	9	-	grams
Schematic Diagrams									
(Top View)									
Option 2									
Option 3									

SPECIFICATIONS

TFT61AXXXX
1-Form-A
High Voltage

TFT71AXXXX
1-Form-A
High Power
Rhodium Contact

PARAMETER	CONDITIONS	SYMBOL	MIN	TYP	MAX	MIN	TYP	MAX	UNITS
Contact Ratings									
Switching Voltage	Max DC/PeakAC Resistive	V_L	-	-	500	-	-	200	Volts
Switching Current	Max DC/PeakAC Resistive	I_L	-	-	0.5	-	-	1	Amps
Carry Current	Max DC/PeakAC Resistive	I_C	-	-	1	-	-	2	Amps
Contact Rating	Max DC/PeakAC Resistive	-	-	-	10	-	-	50	Watts
Life Expectancy	Signal Level 1.0V, 10mA	-	-	500	-	-	100	-	$\times 10^6$ Ops
	Rated Loads	-	-	5	-	-	10	-	$\times 10^6$ Ops
Static Contact Resistance	50mV, 10mA	CR	-	-	150	-	-	150	m Ω
Dynamic Contact Resistance	0.5V, 50mA at 100Hz, 1.5 msec	DCR	-	-	200	-	-	200	m Ω
Contact Material		-	-	Ru or Rh	-	-	Rh	-	-
Relay Specifications									
Insulation Resistance	Between all isolated pins at 100V, 25°C, 40%RH	IR	10^{10}	-	-	10^{10}	-	-	Ω
Capacitance Across Open Contacts	1 KHz Test Signal	-	-	0.7	-	-	0.75	-	pF
	Contact to Coil	1 KHz Test Signal	-	3.5	-	-	4	-	pF
Dielectric Strength	Between Contacts	-	1500	-	-	300	-	-	VDC/peak AC
	Contacts to Coil	I/O	2500	-	-	2500	-	-	VDC/peak AC
Operate Time, including bounce	At Nominal coil voltage, 30Hz Square Wave	T_{OP}	-	0.5	-	-	-	1	msec.
Release Time	Zener-Diode Suppression	T_{REL}	-	0.25	-	-	0.2	-	msec.
Environmental Ratings									
Storage Temperature		T_A	-35	-	+100	-35	-	+100	°C
Operating Temperature		T_O	-20	-	+85	-20	-	+85	°C
Soldering Temperature	Applied to pins, 5 sec. max.	-	-	-	+260	-	-	+260	°C
Vibration Resistance	1Hz - 2000Hz	G	-	-	20	-	-	20	Gs
Shock Resistance	11±1ms, 1/2 Sine Wave	S	-	-	50	-	-	50	Gs
Weight		-	-	9	-	-	9	-	grams
Schematic Diagrams									
(Top View) Option 2									
Option 3									

TFT SERIES REED RELAYS

General Purpose SIL Relay

SPECIFICATIONS

TFT91AXXXX

1-Form-A
1 Amp, 800V Dielectric
Ruthenium Contact

PARAMETER	CONDITIONS	SYMBOL	MIN	TYP	MAX	UNITS
Contact Ratings						
Switching Voltage	Max DC/PeakAC Resistive	V_L	-	-	250	Volts
Switching Current	Max DC/PeakAC Resistive	I_L	-	-	1	Amps
Carry Current	Max DC/PeakAC Resistive	I_c	-	-	3	Amps
Contact Rating	Max DC/PeakAC Resistive	-	-	-	40	Watts
Life Expectancy	Signal Level 1.0V, 10mA	-	-	500	-	$\times 10^6$ Ops
	Rated Loads	-	-	10	-	$\times 10^6$ Ops
Static Contact Resistance	50mV, 10mA	CR	-	-	125	m Ω
Dynamic Contact Resistance	0.5V, 50mA at 100Hz, 1.5 msec	DCR	-	-	200	m Ω
Contact Material		-	-	Ru or Rh	-	-
Relay Specifications						
Insulation Resistance	Between all isolated pins at 100V, 25°C, 40%RH	IR	10^{10}	-	-	Ω
Capacitance Across						
Open Contacts	1 KHz Test Signal	-	-	0.75	-	pF
Contact to Coil	1 KHz Test Signal	-	-	3.5	-	pF
Dielectric Strength	Between Contacts	-	800	-	-	VDC/peak AC
	Contacts to Coil	I/O	2500	-	-	VDC/peak AC
Operate Time, including bounce	At Nominal coil voltage, 30Hz Square Wave	T_{OP}	-	0.5	-	msec.
Release Time	Zener-Diode Suppression	T_{REL}	-	0.25	-	msec.
Environmental Ratings						
Storage Temperature		T_A	-35	-	+100	°C
Operating Temperature		T_O	-20	-	+85	°C
Soldering Temperature	Applied to pins, 5 sec. max.	-	-	-	+260	°C
Vibration Resistance	1Hz - 2000Hz	G	-	-	20	Gs
Shock Resistance	11±1ms, 1/2 Sine Wave	S	-	-	50	Gs
Weight		-	-	9	-	grams
Schematic Diagrams						
(Top View) Option 2						
Option 3						

COIL SPECIFICATIONS

	Contact Form	Coil Voltage			Coil Resistance			Operate Voltage			Release Voltage		
Units		Volts			Ω			Volts			Volts		
Conditions					±10% (25°C)			Must operate by (25°C)			Must release by (25°C)		
Part #		Min	Typ	Max	Min	Typ	Max	Min	Typ	Max	Min	Typ	Max
TFT31C05XX	1-Form-C		5	8	315	350	385			3.6	0.4		
TFT31C12XX	1-Form-C		12	16	900	1000	1100			9	1		
TFT31C24XX	1-Form-C		24	30	1800	2000	2200			18	2		
TFT41A05XX	1-Form-A		5	8	450	500	550			3.6	0.4		
TFT41A12XX	1-Form-A		12	16	900	1000	1100			9	1		
TFT41A24XX	1-Form-A		24	30	1800	2000	2200			18	2		
TFT61A05XX	1-Form-A		5	8	315	350	385			3.6	0.4		
TFT61A12XX	1-Form-A		12	16	900	1000	1100			9	1		
TFT61A24XX	1-Form-A		24	30	1800	2000	2200			18	2		
TFT71A05XX	1-Form-A		5	8	315	350	385			3.6	0.4		
TFT71A12XX	1-Form-A		12	16	900	1000	1100			9	1		
TFT71A24XX	1-Form-A		24	30	1800	2000	2200			18	2		
TFT91A05XX	1-Form-A		5	8	315	350	385			3.6	0.4		
TFT91A12XX	1-Form-A		12	16	900	1000	1100			9	1		
TFT91A24XX	1-Form-A		24	30	1800	2000	2200			18	2		

MECHANICAL DIMENSIONS

TFT SERIES – Nickel-Plated Steel Cover

DIMENSIONS
mm
(inches)

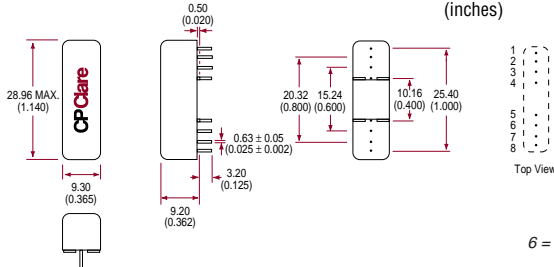

TFT SERIES – Plastic Cover

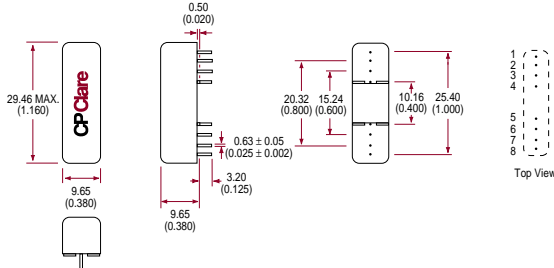

ORDERING INFORMATION

A complete part number is represented by the digits below. For example, TFT71A0522 is a high power, 1-Form-A relay with a 5V coil in a magnetically shielded steel case.

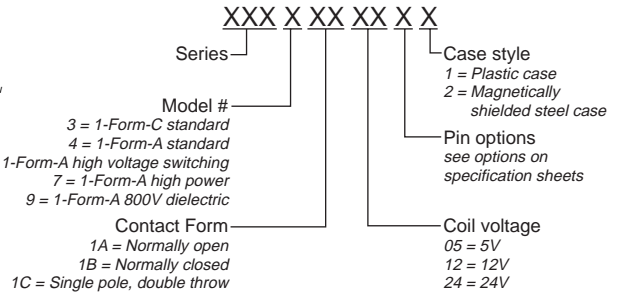

Low Power & Current Sensing



DESCRIPTION

The LM, LX, and LQ series provide reliable low-power switching for telecom and general purpose loads. The bifurcated contacts are a silver alloy with a gold cap so that loads from microamps to 2 Amps can be switched. Due to the highly efficient magnetic structure, a low coil power of 140 to 300 mW is needed to drive these relays. These relays also have UL and CSA listing at 2 Amps and meet FCC part 68 surge strength of 1500 Volts.

FEATURES

- Low coil power
- Wide switching range
- DPDT bifurcated contacts
- 2 Amp UL/CSA rating
- Sealed construction
- FCC Part 68 Compatible (1500V)

APPLICATIONS

- Telecom
- Security
- Signaling

AGENCY APPROVALS

- UL/CSA Recognized Approved

RATINGS (@ 25° C)

Parameter	Min	Typ	Max	Unit
Switching Voltage			220	Volts
Switching Current			2	Amps
Carry Current			2	Amps
Contact Rating			125	VA
Insulation Resistance			10 ⁹	Ω

(See detailed specifications for more information.)

SPECIFICATIONS

All characteristics at 20°C.

PARAMETER	CONDITIONS	SYMBOL	LQ 2-Form-C 10 Pin DIP			LM 2-Form-C 16 Pin DIP			LX 2-Form-C 16 Pin DIP			UNITS
			MIN	TYP	MAX	MIN	TYP	MAX	MIN	TYP	MAX	
Contact Ratings												
Switching Voltage	Max DC/PeakAC Resistive	V_L	-	-	220	-	-	150	-	-	220	Volts
	Max AC/RMS Resistive	V_L	-	-	250	-	-	125	-	-	250	Volts
Switching Current	Max DC	I_L	-	-	2	-	-	2	-	-	2	Amps
Carry Current	Max DC	I_C	-	-	2	-	-	2	-	-	2	Amps
Contact Rating	Max DC/PeakAC Resistive	-	-	-	30/62.5	-	-	30/60	-	60/125	-	w/VA
Life Expectancy	Mechanical	-	-	100	-	-	20	-	-	20	-	$\times 10^6$ Ops
	2A, 24 VDC	-	-	10	-	-	10	-	-	10	-	$\times 10^4$ Ops
	0.5A, 125 VAC	-	-	20	-	-	20	-	-	20	-	$\times 10^4$ Ops
	0.5A, 24 VDC	-	-	2	-	-	2	-	-	2	-	$\times 10^6$ Ops
Static Contact Resistance		CR	-	-	50	-	-	100	-	-	100	mΩ
Contact Material		-	-	Au	-	-	Au	-	-	Au	-	-
		-	-	Ag Alloy	-	-	AgPd	-	-	AgPd	-	-
Relay Specifications												
Insulation Resistance	Between all isolated pins at 100V, 25°C, 40% RH	IR	10^9	-	-	10^9	-	-	10^9	-	-	Ω
Capacitance	Across Open Contacts	-	-	0.5	-	-	0.9	-	-	1.5	-	pF
	Open Contact to Coil	-	-	1.0	-	-	1.9	-	-	1.7	-	pF
Dielectric Strength	Across Open Contacts	-	1000	-	-	500	-	-	1000	-	-	VAC
	Coil to Contacts	-	1000	-	-	1000	-	-	1500	-	-	VAC
	Adjacent Poles	-	1000	-	-	1000	-	-	1500	-	-	VAC
Operate Time, including bounce	At Nominal Coil Voltage 10Hz Square Wave	T_{OP}	-	-	6	-	-	10	-	-	7	ms
Release Time	Zener-Diode Suppression	T_{REL}	-	-	3	-	-	3	-	-	4	ms
Environmental Ratings												
Storage Temperature		T_A	-40	-	+85	-30	-	+80	-40	-	+80	°C
Operating Temperature		T_O	-40	-	+85	-30	-	+80	-40	-	+80	°C
Soldering Temperature	Applied to pins, 5 sec. max.	-	-	-	+260	-	-	+260	-	-	+260	°C
Vibration Resistance	10Hz - 55Hz	G	-	-	20	-	-	10	-	-	30	G
Shock Resistance	11±1ms, 1/2 Sine Wave	S	-	-	50	-	-	50	-	-	50	G
Weight		-	-	1.2	-	-	5	-	-	3.7	-	grams

COIL SPECIFICATIONS

Units	Coil Voltage			Coil Resistance			Operate Voltage			Release Voltage		
	Volts			Ω			Volts			Volts		
Conditions				±10%, (25°C)			Must operate by (25°C)			Must release by (25°C)		
Part #	Min	Typ	Max	Min	Typ	Max	Min	Typ	Max	Min	Typ	Max
LQ52A00		3		57.87	64.3	70.73			2.1	0.3		
LQ52B00		5		160.2	178	195.8			3.5	0.5		
LQ52C00		6		231.3	257	282.7			4.2	0.6		
LQ52D00		12		925.2	1028	1130.8			8.4	1.2		
LQ52E00		24		2592	2880	3168			16.8	2.4		
LQ52F00		48		6912	7680	8448			33.6	4.8		
LM44B00		5		150.3	167	183.7			3.6	0.25		
LM44D00		12		864	960	1056			8.5	0.6		
LM44E00		24		2592	2880	3168			16.8	1.2		
LM44F00		48		6912	7680	8448			32.6	2.4		
LX200B00		5		112.5	125	137.5			3.4	0.5		
LX200D00		12		648	720	792			8.1	1.2		
LX200E00		24		2592	2880	3168			16.1	2.4		
LX200F00		48		10368	11520	12672			32.2	4.8		

MECHANICAL DIMENSIONS

DIMENSIONS mm (inches)

LQ 2-Form-C

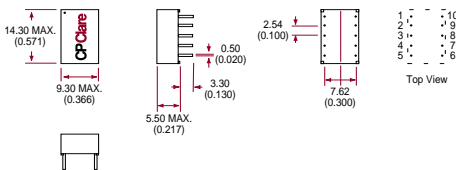

LQ 2C Pinout



LM 2-Form-C

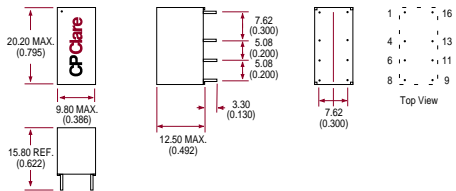

LM 2C Pinout

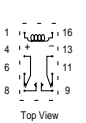

LX 2-Form-C

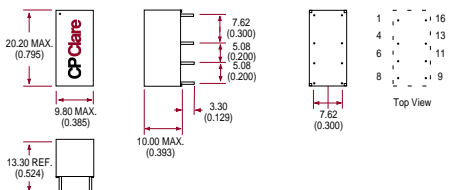

LX 2C Pinout

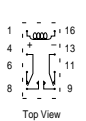

ORDERING INFORMATION

A complete part number is represented by the digits below.

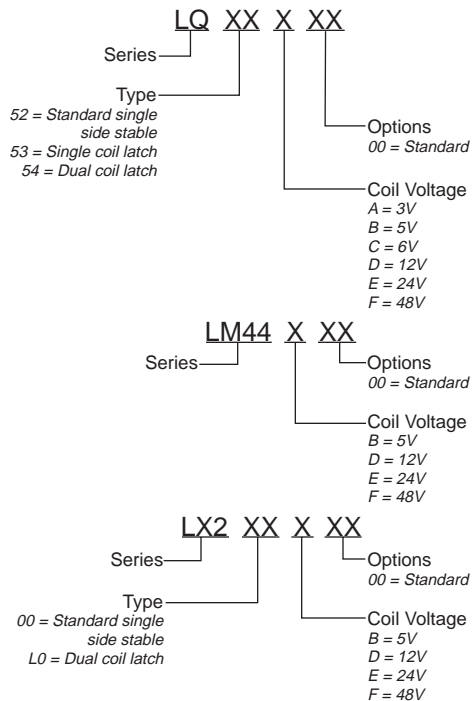

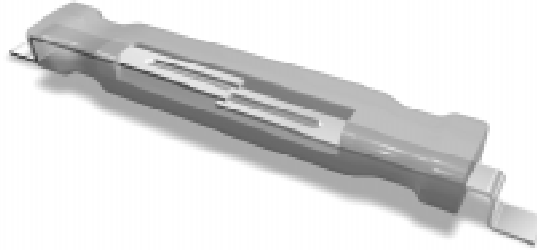
Reed Switches and Reed Sensors Introduction

CP Clare's patented approach to manufacturing Dry Reed Switches is quite different from anyone who is currently making reed switches in the world. The typical approach is to use a round glass tube with 2 reed blades protruding from each end and sealing the glass to the reeds with an IR band or a focused lamp approach. CP Clare uses modern Laser sealing, whereby exact heating for sealing and glass annealing can be designed into the laser beam shape, focus and intensity. Expensive retooling is not required when changing or designing a different reed which can be smaller or multi-functional; but rather, one simply re-focuses and repositions the laser. Also, since the laser operates in a container that is first evacuated and back-filled with inert gas, the risk of contamination from particle matter is dramatically reduced.

Many companies also plate the contact areas with hard metals (Rhodium, Ruthenium, etc.) for better switching of hot loads. This plating approach inherently leaves materials trapped in micro voids or cracks which tend to leach onto the contact surface during use. This debris on the contacts typically can cause anything from polymer growth to outright covalent bonding of the two reeds creating a shorting condition. For this reason some companies (CP Clare included) have found that sputtering these same hard metals on the contacts is a much more reliable approach for both low level and 'hot' switching conditions.

Several of the key features are shown in the photo and cutaway of the DYAD®. The bifurcated contacts offer extended life in the intermediate voltage range from 10 volts to 50 volts; and in addition, the DYAD® shows superior performance for contact resistance stability.

Many reed switch sensor applications require more than just the reed switch. Many require plastic or metal

enclosures with external magnets or external magnetic fields. CP Clare's engineers are available to help in these design-in applications and are willing to work with you if tooling is required. Applications requiring PCB mounting, levels sensors, special connectors, wire leads, etc. are standard procedure.

Reed Switch Features:

- Surface Mountable
- Hermetically Sealed
- Low Contact Resistance (<200mΩ)
- Sputtered Ruthenium Contacts
- Bifurcated Contacts (DYAD® Only)
- Minimal Contact Bounce
- 10 Watt Switching Capability
- Small Size (smallest 10mm)
- Magnetically Actuated
- UL Pending

Many of our reed switches are used in the following market segments and applications:

- Industrial Control
 - Flow Meters
 - Level Meters
- Automotive
 - Current Sensing
 - Shock Sensing
 - Level Control
 - Temperature Sensing
- Security
 - Smoke Alarms
 - Magnetic Proximity Sensor
- Telecom
 - Isolation Circuit
 - Hookswitch
 - Antenna Switching

REED SWITCHES

MN1 ■ FR2



DESCRIPTION

CP Clare's DYAD® and Mini-DYAD™ dry reed switches are ideally suited for small switching signal applications. Both switches have sputtered ruthenium contacts and an extraordinary seal strength, achieved by a patented laser sealing of the glass. In low level or dry switching environments, both switches typically provide >1 billion operations. All of the switches have hermetically sealed contacts and offer a wide range of available magnetic sensitivities.

FEATURES

- Small size
- SMT-compatible
- Easily formed leads
- Sputtered ruthenium contacts
- Hermetically sealed contacts
- Fast switching speed — up to 500Hz
- Wide range of available magnetic sensitivities

APPLICATIONS

- Security
 - Proximity sensing
 - Smoke alarms
- Automotive
 - Level sensor
 - Lamp current sensor
- Relays

AGENCY APPROVALS

- UL pending

RATINGS (@ 25° C)

Parameter	Min	Typ	Max	Units
Switching Voltage				
MN1 - Mini-DYAD™			200	Volts
FR2 - DYAD®			200	Volts
Switching Current				
MN1 - Mini-DYAD™			0.5	Amps
FR2 - DYAD®			0.5	Amps
Carry Current				
MN1 - Mini-DYAD™			2	Amps
FR2 - DYAD®			1.5	Amps
Switching Frequency				
MN1 - Mini-DYAD™			500	Hz
FR2 - DYAD®			500	Hz
Contact Resistance				
MN1 - Mini-DYAD™			100	mΩ
FR2 - DYAD®			150	mΩ

(See detailed specifications for more information.)

SPECIFICATIONS

MN1
Mini-DYAD™
Form-A

FR2
DYAD®
Form-A

All parameters are at 25°C unless otherwise stated.

PARAMETER	CONDITIONS	SYMBOL	MIN	TYP	MAX	MIN	TYP	MAX	UNITS
Contact Ratings									
Operate ampere turns range	Full Blade Tolerance = ± 1.5NI	AT	10	-	25	10	-	30	NI
Release ampere turns range	Full Blade Tolerance = ± 1.5NI	AT	5	-	25	5	-	30	NI
Switching Voltage	Max DC/PeakAC Resistive	V _L	-	-	200	-	-	200	VDC
Switching Current	Max DC/PeakAC Resistive	I _L	-	-	500	-	-	500	mAmps
Carry Current	Max DC/PeakAC Resistive	I _C	-	-	2.0	-	-	1.5	Amps
Contact Rating	Max DC/PeakAC Resistive	-	-	-	10	-	-	10	VA
Life Expectancy	1V, 10mA Signal Level	-	-	1000	-	-	1000	-	x10 ⁶ Ops
	10V, 10mA Low Level	-	-	500	-	-	500	-	x10 ⁶ Ops
	50V, 100mA Telecom Load	-	-	2	-	-	2	-	x10 ⁶ Ops
	100V, 100mA Rated Loads	-	-	2	-	-	2	-	x10 ⁶ Ops
Static Contact Resistance	50mV, 10mA ⁽¹⁾	CR	-	70	100	-	80	150	mΩ
Dynamic Contact Resistance	0.5V, 50mA at 100Hz, 1.5 msec.	DCR	-	90	-	-	150	-	mΩ
Contact Material		-	-	Ru	-	-	Ru	-	-
Switch Specifications									
Insulation Resistance ⁽²⁾	100V, 25°C, 40% RH	IR	-	10 ¹²	-	-	10 ¹²	-	Ω
Capacitance	Across Open Contacts	-	-	0.3	-	-	0.3	-	pF
Dielectric Strength ⁽⁵⁾	Between Contacts	-	250	300	-	250	300	-	VDC/Peak AC
Operate Time, including bounce	At nominal coil voltage, 10Hz Square Wave	T _{OP}	-	-	0.5	-	-	0.5	ms
Release Time	Zener-Diode Suppression ⁽³⁾	T _{REL}	-	-	0.1	-	-	0.2	ms
Environmental Ratings									
Storage Temperature		T _A	-40	-	+125	-40	-	+125	°C
Operating Temperature		T _O	-40	-	+125	-40	-	+125	°C
Soldering Temperature		-	-	-	+265	-	-	+240	°C
Vibration Resistance	5Hz - 200Hz	G	-	-	20	-	-	20	Gs
Shock Resistance	11±1ms, 1/2 Sine Wave	S	-	-	50	-	-	100	Gs
Weight		-	-	0.12	-	-	0.13	-	grams/unit

⁽¹⁾ Contact resistance measured with 4 terminal method, 1.1" between test leads

⁽²⁾ >10¹² W is available upon request

⁽³⁾ A 24V zener in series with a diode across the coil

⁽⁴⁾ Use caution not to exceed vibration resistance limits while ultrasonically cleaning. Contact CP Clare Engineering for more details/recommendations

⁽⁵⁾ 15 ampere turn minimum

STANDARD TEST COIL

The magnetic force (expressed in NI, AT or Ampere Turns) required to cause the reed switch contacts to close is called the pull-in or operate value.

	MN1	FR2
Coil definition	NARM1 CTC01	NARM1 CTC01
Coil resistance	1200Ω	1200 Ω
Number of turns	5,000	5,000
Wire size (nom. diameter)	0.0399mm	0.0399mm
Bobbin diameter (inside coil)	3.96mm	3.96mm
Winding length	10.4mm	10.4mm

⁽¹⁾ Consult factory for test procedure.

The reed switch shall be placed in the test coil with the gap centered in the core of the coil winding. Test leads and their clips must be non-magnetic. The longitudinal axis of the test coil and the test switch shall be vertical.

ORDERING INFORMATION

A complete part number is represented by the digits below. For example, MN1S1030-0530 is a Mini-DYAD™ with solder-plated leads, minimum operate value of 10, maximum of 30 and minimum release value of 5, maximum of 30. Refer to the switch operating specification charts for available ranges. Special ranges are available upon request.

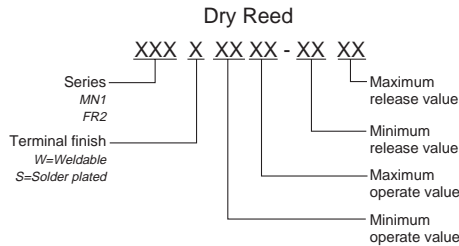

Surface Mount Dry Reed

Refer to operating characteristics table for a complete part number.

SWITCH OPERATING SPECIFICATIONS

DRY REED

DYAD®

Part # ¹	Operate Range (NI) ²	Release (NI)
FR2S1015-0515	10 to 15	5 to 15
FR2S1020-0520	10 to 20	5 to 20
FR2S1030-0530	10 to 30	5 to 30
FR2S1520-0520	15 to 20	5 to 20
FR2S1525-0525	15 to 25	5 to 25
FR2S2025-0525	20 to 25	5 to 25

Mini-DYAD™

Part # ¹	Operate Range (NI) ²	Release (NI)
MN1S1015-0515	10 to 15	5 to 15
MN1S1020-0520	10 to 20	5 to 20
MN1S1030-0530	10 to 30	5 to 30
MN1S1520-0520	15 to 20	5 to 20
MN1S1525-0525	15 to 25	5 to 25
MN1S2025-0525	20 to 25	5 to 25

DYAD® Surface Mount

Part #	Operate Range (NI) ^{2,3}	Release Range (NI)
FR2024	10 to 15	5 to 15
FR2259	10 to 20	5 to 20
FR2282	10 to 30	5 to 30
FR2025	15 to 20	5 to 20
FR2249	15 to 25	5 to 25
FR2026	20 to 25	5 to 25

Mini-DYAD™ Surface Mount

Part #	Operate Range (NI) ^{2,3}	Release Range (NI)
MN2308	10 to 15	5 to 15
MN2288	10 to 20	5 to 20
MN2339	10 to 30	5 to 30
MN2285	15 to 20	5 to 20
MN2289	15 to 25	5 to 25
MN2286	20 to 25	5 to 25

¹ Weldable Leads available, see ordering information

² Tolerance = ± 1.5NI

³ Full Blade Sensitivity

PERFORMANCE GRAPHS

DYAD®

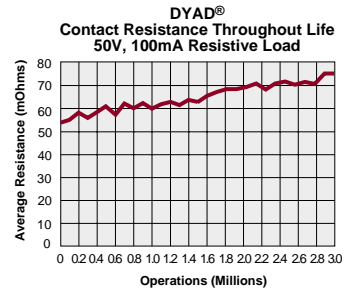
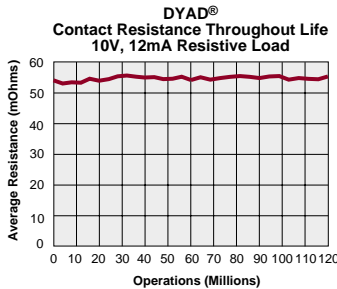
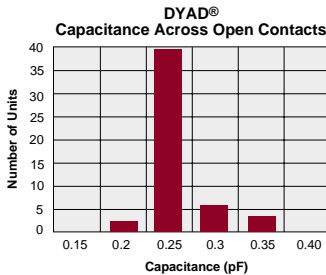
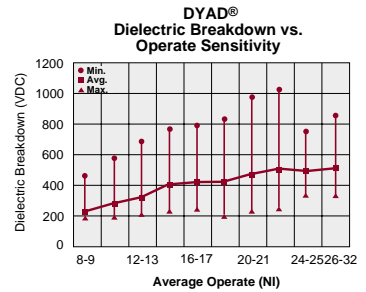
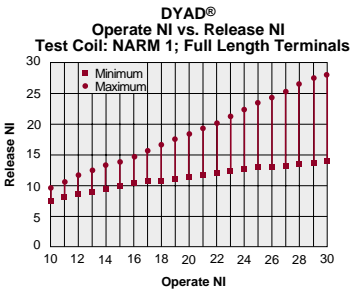

Mini-DYAD™

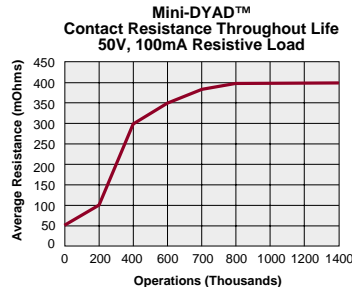
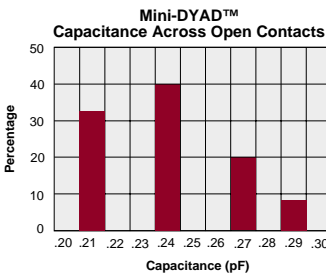
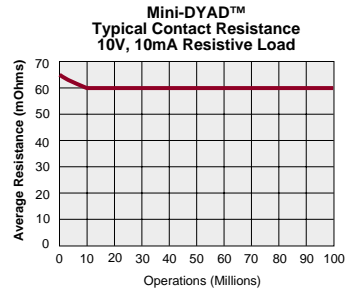
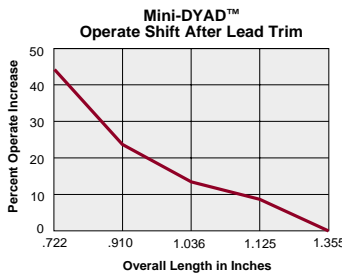
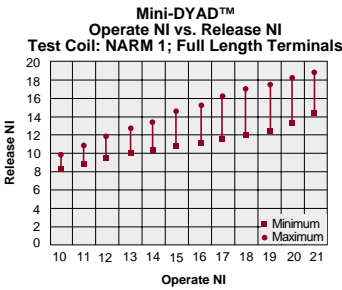

MECHANICAL DIMENSIONS

DIMENSIONS
mm
(inches)

Mini-DYAD™

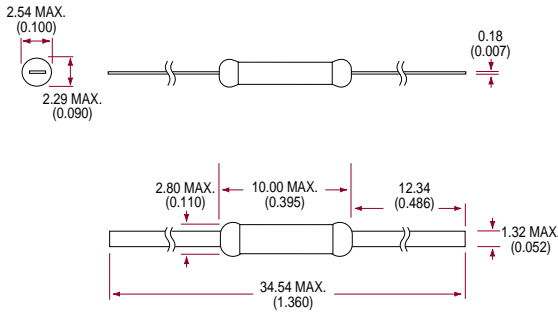

DYAD®

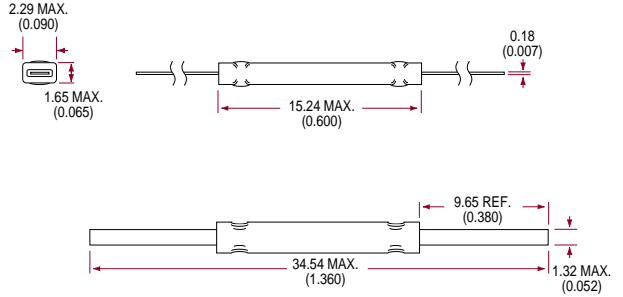

Mini-DYAD™ SMT

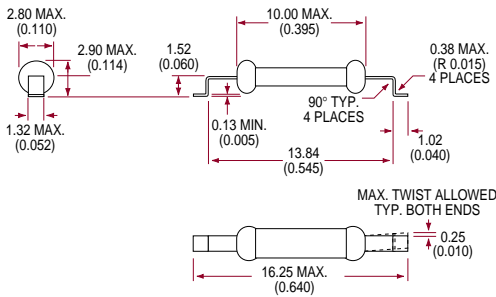

DYAD® SMT

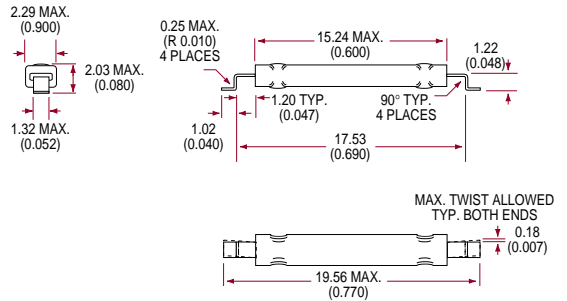

RECOMMENDED PAD SIZES

Mini-DYAD™ SMT

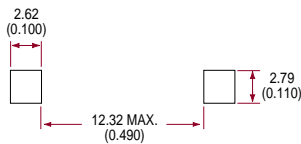

DYAD® SMT

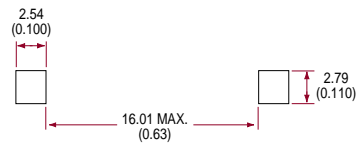

TAPE & REEL PACKAGING

DIMENSIONS
mm
(inches)

Tape and Reel Packaging for DYAD®-Gull Wing Terminals

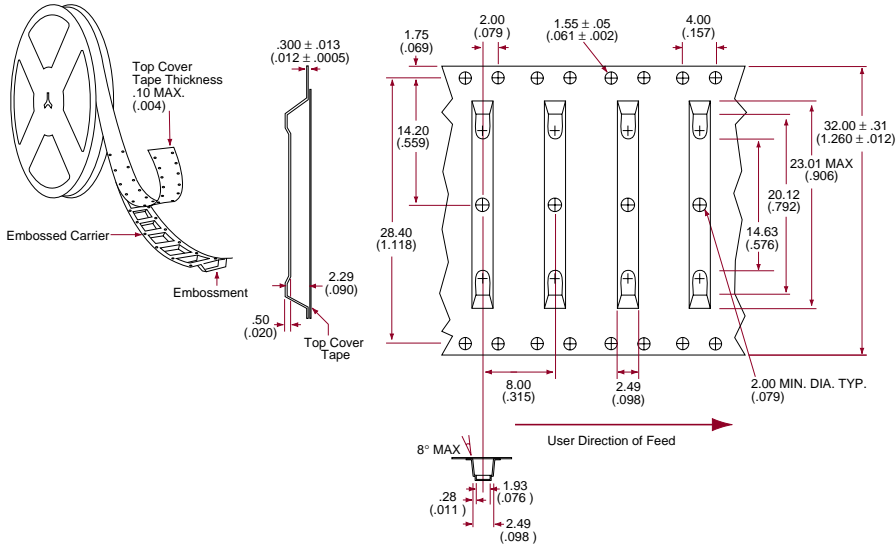

Tape and Reel Packaging for SMT Mini Switch

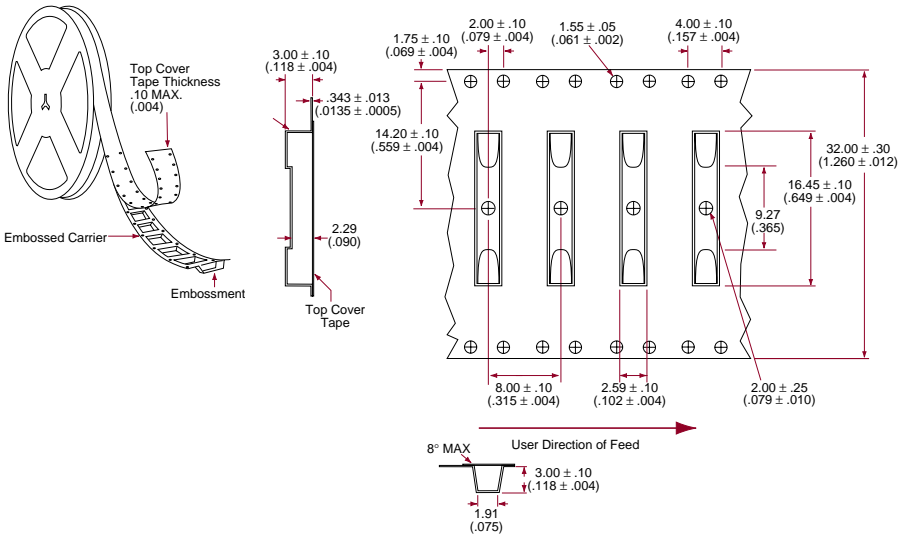

Reed Switches

WHAT IS A REED SWITCH?

The basic reed switch consists of a pair of low reluctance ferromagnetic reeds, which overlap at their free ends — the contact area. The reeds are hermetically sealed in a narrow glass tube to protect the contact area from contamination by external effects of dust, moisture, oils, etc. When a magnetic field is brought in proximity to the reeds, the extreme ends assume opposite magnetic polarity. When the magnetic field is strong enough, the overlapping ends attract and are brought together, completing an electrical circuit. When the field is removed, the reeds separate, by their own spring tension, back to their original, normally open position.

The principal advantages of a reed switch include:

- Hermetically sealed contacts
- Low resistance when contacts are closed (<200m Ω)
- High isolation resistance when contacts are open (typically 10^{12} Ω)
- Complete isolation between input and output
- Long life where needed; predictability when only occasional actuation is required

ENHANCEMENTS TO REED TECHNOLOGY

Since the invention of glass-enclosed contacts in the late 1950s, the technique for producing them has remained the same — so much that there are commonly identified issues with using reeds.

CP Clare Corporation has addressed each of these issues. The DYAD[®] is not just another reed switch. Immediate improvements in end-product reliability,

production yields, and switching characteristics at low level loads (12V, 10-30mA) can be experienced with this switch.

Advantages specific to the Clare DYAD[®] reed switch include:

- Flexible leads can be bent or formed without breaking or stressing the switch seal.
- Flat reed design provides a larger surface area for weld, solder or crimp joints, resulting in stronger, more reliable connections.
- Flat leads provide the capability for surface mounting; it is compatible with vapor phase and reflow soldering processes.
- A Ruthenium contact exhibits less wear, provides stable contact resistance throughout life, and exhibits virtually no tendency to cold weld or stick.

APPLICATION FOR REED SWITCHES

Over the past three decades, billions of reeds have been used in thousands of applications. The current trend in the design of automobiles, security systems, consumer goods and business machines calls for more sophisticated electronic controls. The large degree of electronic design effort has also brought with it a need for higher levels of reliability. This increases the need for a reliable, low-cost sensor to measure various parameters such as speed, position, direction and current or temperature changes. The reed switch is an economical, non-contact switching alternative to the push switch, microswitch and solid state switch. And where load-switching requirements are microamps or milliamps, the reed switch is an ideal solution.

Reed Switches

Magnetic sensitivity

This rating specifies the amount of magnetism used to close the switch. Switches are ordered based on their full-length operate sensitivity, expressed in Ampere Turns (NI or AT). At CP Clare, this is done based on a NARM 1 coil:

Standard Test Coil

The magnetic force (expressed in NI, AT or Ampere Turns) required to cause the reed switch contacts to close is called the pull-in or operate value.

Coil definition	EIA/NARM I Standard
Wire size	AWG 46
Number of turns	5000 ± 5 turns
Coil resistance	1200 Ohms ± 10%
Recommended mounting conditions	Vertical, with the coil magnetic field opposing the local earth's magnetic field

The reed switch shall be placed in the test coil with the gap centered in the core of the coil winding. Test leads and their clips must be non-magnetic. The longitudinal axis of the test coil and the test switch shall be vertical.

Length vs. magnetic sensitivity

The leads of a reed switch are the “antennae” that pick up the flux of the magnetic field. The full-length switch is the most sensitive. As a switch is cut shorter, it becomes less sensitive.

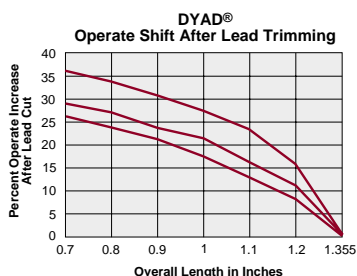
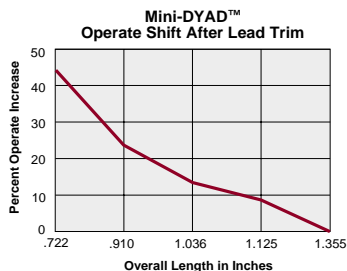

Coil Actuation

The operation of a reed switch via an electromagnetic coil provides the designer with a method of actuation from a remote source. This is a very simple method of actuation.

When the reed switch is placed inside or close to a coil of wire and a current is passed through the coil, each lead of the reed switch becomes strongly magnetized. One end of the reed switch will become a north pole and the other a south pole. Because the reed blades overlap in the center of the glass housing, with a few thousandths of an inch separating the overlapping ends, each lead will have a north and south pole. The overlapping reed blades come together (close) when the electrical current generates sufficient magnetic flux in the coil. When the current to the coil is turned off, the reed blades return to their open condition.

The efficiency of the reed switch actuation is largely dependent upon the coil. The size, shape, wire type, and the number of turns of wire on the coil determine its efficiency. In addition, the proximity of the switch to the coil determines the efficiency of the coil (ie, if the switch is placed inside or very close to the coil, the coil requires little current to actuate the switch. The farther the switch is from the coil, the more magnetic flux the coil must generate to cause switch closure). A single coil can actuate two or more switches.

Permanent Magnet Actuation

A permanent magnet is the most common means of operating the reed switch. As with a coil, a magnet and switch must be positioned within a specific proximity of each other to actuate the reed switch. This distance is related to the sensitivity of the switch and the strength of the magnet. For the normally open reed switch, when the magnetic field is close enough, the contacts will close; when the magnetic field is taken away, the contacts will open. There are many ways to use a permanent magnet to actuate the reed switch. We have addressed the most popular techniques in the following figures.

Reed Switches

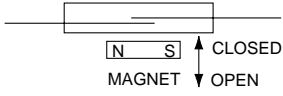

1) As the magnet moves closer to the switch, the switch is activated. Figure 1 shows that as you get closer with the poles centered over the contact gap, you will close the switch. As you move away, the field reduces by the square of the distance, and the switch will open. This type of movement is typical of many proximity applications, such as alarm or telecom systems.

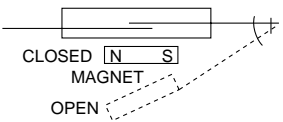

2) In this application, the magnet may swing away from the switch. As the distance decreases, the switch closes. This is typical of a security or safety door contact application. If you imagine the magnet rotating at a larger radius than the switch, the effect is the same. When the switch and the magnet are end-to-end, the switch is closed. This is commonly found in level sensors and security applications.

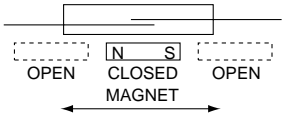

3) In this motion, the magnet moves parallel to the switch. When centered, the switch is closed; when moved slightly to either side, the switch will open. If movement continues away from the gap, closure will again occur. Figure 1 shows how the field strength varies by distance. This type of actuation is very common in automotive and industrial level detectors. Note: the on/off characteristics vary greatly by turning the magnet 90°, as shown in figure 2.

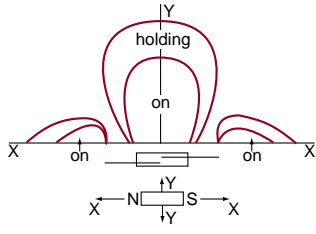
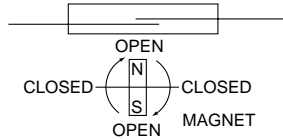
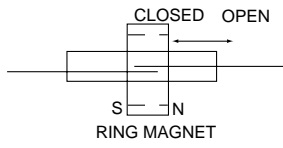

Figure 1



4) This extends the application to rotation of the magnet. As the magnet makes one full revolution, the switch will close twice when the poles of the magnet are parallel with the switch. This could be used for metering of counting the cycles of a rotating shaft.



5) This is a ring magnet with poles at the faces. As the ring is moved to the center of the gap, the switch closes. At either end, the switch is open. This can be used effectively in a level control or a deceleration sensor.

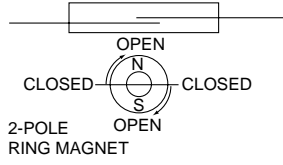

6) The ring magnet, when attached to a rotating device, can be used to activate the switch to act as a counter. This is similar to the rotating bar application in that when the magnet poles are parallel to the switch, the switch is closed. For each revolution, the switch closes twice.

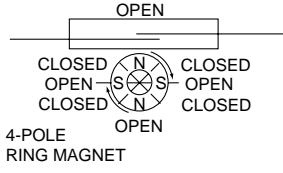

7) Taking application 6 one step further, higher resolution can be found by going to a 4-pole ring magnet. This would yield 4 closures per revolution.

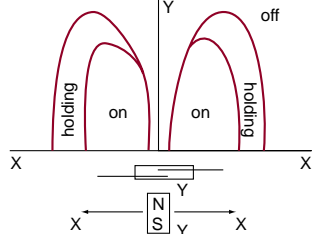

Figure 2





CP Clare's Comgap gas discharge tube (GDT) surge arrester devices or spark gaps protect personnel and electrical equipment from damaging high voltage transients induced by lightning, inductive switching, or electrostatic discharge. Depending upon the application, CP Clare offers a variety of two and three

electrode Comgaps for protecting telecommunication, test, computer, power supply, medical, and cable television equipment. Along with protecting circuits, Comgaps can also be used as switches to create a discharge voltage in circuits used for medical, gas ignition, and HID lighting applications.

TWO ELECTRODE AC LINE PROTECTORS

AC Series



DESCRIPTION

CP Clare's two electrode AC Line Protectors are designed for a high degree of surge protection in AC line applications at low cost. These gaps are able to extinguish in the presence of AC follow-on currents of at least 300A — therefore, a series current-limiting device is usually not needed to ensure turn-off. AC Line Protectors function as switches which dissipate a minimum amount of energy and therefore handle currents that far surpass other types of transient voltage protection.

FEATURES

- High AC follow-on current capability (>300A-pk)
- Small size
- Rugged ceramic-metal construction
- Low capacitance (<1pF)
- Available with or without Leads
- Available in tape-and-reel packaging

APPROVALS

- Meets IEEE C62.41-1991
- CSA approved file #: LR89617
- UL Recognized: File Number E111526

APPLICATIONS

- Long branch circuits (AC wall outlet)
- Short branch circuits (at breaker box, computer, etc.)
- Power supplies
- Test equipment
- Submersible pumps
- Medical electronics

RATINGS (@ 25° C)

Parameter	Min	Typ	Max	Units
DC Breakdown Voltage	225	-	-	V
Impulse Breakdown Voltage	-	-	700	V
Insulation Resistance	10 ¹⁰	-	-	Ω
Capacitance	-	-	1	pF
Operational Temperature	-40	-	+125	°C

(See detailed specifications for more information.)

SPECIFICATIONS

AC120
AC120L

All characteristics at 25°C

PARAMETERS	CONDITIONS	SYMBOL	MIN	TYP	MAX	UNITS
Device Specifications						
DC Breakdown	500V/s	V_{BD}	225	-	-	V
Impulse Breakdown	100V/ μ s	V_{bd}	-	-	700	V
Insulation Resistance	100V	IR	10^{10}	-	-	Ω
Capacitance	1MHz	$C^{(1-g)}$	-	-	1.0	pF
Arc Voltage	I=5A min	V_{ARC}	-	20	-	V
Life Ratings⁽¹⁾						
Max Current Surge	10kA (8/20 μ s)		4	-	-	shots
AC Current	10x 1sec @ 60Hz		-	N/A	-	A
AC Follow-On Current	1/2 cycle @ 60Hz		-	-	>300	A pk

⁽¹⁾End-of-Life limits are:

DC: same as minimum initial DC breakdown voltage limit

Impulse: less than 150% of initial Impulse breakdown voltage limit.

MECHANICAL DIMENSIONS

DIMENSIONS

mm
(inches)

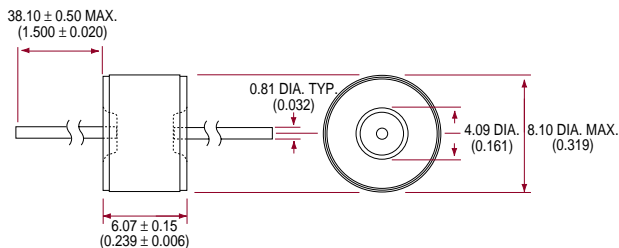

ORDERING INFORMATION

A complete part number is represented by the digits below. For example, AC120 is a non-leaded 120VAC device, and AC120LTR is a leaded 120VAC device on tape-and-reel per EIA standard RS-296-D.

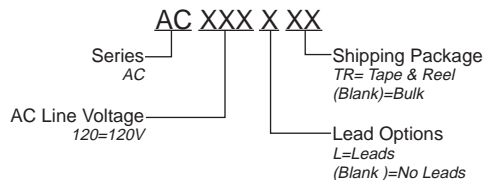

TWO ELECTRODE SURGE ARRESTERS

CG/CG2 Series



DESCRIPTION

CP Clare's two electrode CG/CG2 Comgaps are designed for a high degree of surge protection at a low cost. The CG Series (75-110V) is primarily used for protection of test and communication equipment in which low voltage limits and extremely low arc voltages are required. The CG2 Series (145V-1000V) is used for the protection of test and communication equipment for which higher voltage limits and holdover voltages are necessary. Comgaps function as switches which dissipate a minimum amount of energy and therefore handle currents that far surpass other types of transient voltage protection.

FEATURES

- Small size
- Rugged ceramic-metal construction
- Low capacitance (<1pF)
- Non Radioactive 600-1000 V
- Available with or without leads
- Available in tape-and-reel packaging

APPLICATIONS

- Communication lines
- CATV equipment
- Test equipment
- Data lines
- Power supplies
- Instrumentation circuits
- Medical electronics

APPROVALS

- UL Recognized: File Number E111526
- Meets REA PE-80

RATINGS (@ 25° C)

Parameter	Min	Typ	Max	Units
DC Breakdown Voltage	60	75	90	V
	72	90	108	V
	88	110	132	V
	116	145	174	V
	195	230	265	V
	213	250	288	V
	255	300	345	V
	297	350	403	V
	400	470	540	V
	510	600	690	V
	680	800	920	V
	850	1000	1150	V
Insulation Resistance	10 ¹⁰	-	-	Ω
Capacitance	-	-	1	pF
Operational Temperature	-40	-	+125	°C

(See detailed specifications for more information.)

SPECIFICATIONS

All characteristics at 25°C

PARAMETER	CONDITIONS	SYMBOL	CG75			CG90			CG110			UNITS
			MIN	TYP	MAX	MIN	TYP	MAX	MIN	TYP	MAX	
Device Specifications												
DC Breakdown	500V/s	V_{BD}	60	75	90	72	90	108	88	110	132	V
Impulse Breakdown	100V/ μ s	V_{bd}	-	-	400	-	-	400	-	-	450	V
Insulation Resistance	50V	IR	10 ¹⁰	-	-	10 ¹⁰	-	-	10 ¹⁰	-	-	Ω
Capacitance	1MHz	C	-	-	1	-	-	1	-	-	1	pF
Arc Voltage	I=5A min	V_{ARC}	-	10	-	-	10	-	-	10	-	V
Life Ratings⁽¹⁾												
Surge Life	500A (10/1000 μ s)	-	1000	-	-	1000	-	-	1000	-	-	shots
Max Current Surge	20kA (8/20 μ s)	-	5	-	-	5	-	-	5	-	-	shots
AC Current	10x 1sec @ 60Hz	-	-	-	20	-	-	20	-	-	20	A
DC Holdover Voltage	per REA PE-80, 0.2A	-	-	55	-	-	65	-	-	80	-	V

PARAMETER	CONDITIONS	SYMBOL	CG2-145			CG2-230			CG2-250			UNITS
			MIN	TYP	MAX	MIN	TYP	MAX	MIN	TYP	MAX	
Device Specifications												
DC Breakdown	500V/s	V_{BD}	116	145	174	195	230	265	213	250	288	V
Impulse Breakdown	100V/ μ s	V_{bd}	-	-	500	-	-	600	-	-	625	V
Insulation Resistance	100V	IR	10 ¹⁰	-	-	10 ¹⁰	-	-	10 ¹⁰	-	-	Ω
Capacitance	1MHz	C	-	-	1	-	-	1	-	-	1	pF
Arc Voltage	I=5A min	V_{ARC}	-	15	-	-	15	-	-	15	-	V
Life Ratings⁽¹⁾												
Surge Life	500A (10/1000 μ s)	-	1000	-	-	1000	-	-	1000	-	-	shots
Max Current Surge	20kA (8/20 μ s)	-	5	-	-	5	-	-	5	-	-	shots
AC Current	10x 1sec @ 60Hz	-	-	-	20	-	-	20	-	-	20	A
AC Follow-on Current	1/2 cycle @ 60Hz	-	-	-	20	-	-	20	-	-	20	A pk
DC Holdover Voltage	per REA PE-80, 0.2A	-	-	90	-	-	150	-	-	150	-	V

PARAMETER	CONDITIONS	SYMBOL	CG2-300			CG2-350			CG2-470			UNITS
			MIN	TYP	MAX	MIN	TYP	MAX	MIN	TYP	MAX	
Device Specifications												
DC Breakdown	500V/s	V_{BD}	255	300	345	297	350	403	400	470	540	V
Impulse Breakdown	100V/ μ s	V_{bd}	-	-	700	-	-	750	-	-	850	V
Insulation Resistance	100V	IR	10 ¹⁰	-	-	10 ¹⁰	-	-	10 ¹⁰	-	-	Ω
Capacitance	1MHz	C	-	-	1	-	-	1	-	-	1	pF
Arc Voltage	I=5A min	V_{ARC}	-	15	-	-	15	-	-	15	-	V
Life Ratings⁽¹⁾												
Surge Life	500A (10/1000 μ s)	-	1000	-	-	1000	-	-	1000	-	-	shots
Max Current Surge	20kA (8/20 μ s)	-	5	-	-	5	-	-	5	-	-	shots
AC Current	10x 1sec @ 60Hz	-	-	-	20	-	-	20	-	-	20	A
AC Follow-on Current	1/2 cycle @ 60Hz	-	-	-	20	-	-	20	-	-	20	A pk
DC Holdover Voltage	per REA PE-80, 0.2A	-	-	150	-	-	150	-	-	150	-	V

PARAMETER	CONDITIONS	SYMBOL	CG2-600			CG2-800			CG2-1000			UNITS
			MIN	TYP	MAX	MIN	TYP	MAX	MIN	TYP	MAX	
Device Specifications												
DC Breakdown	500V/s	V_{BD}	510	600	690	680	800	920	850	1000	1150	V
Impulse Breakdown	100V/ μ s	V_{bd}	-	-	1000	-	-	1200	-	-	1500	V
Insulation Resistance	100V	IR	10 ¹⁰	-	-	10 ¹⁰	-	-	10 ¹⁰	-	-	Ω
Capacitance	1MHz	C	-	-	1	-	-	1	-	-	1	pF
Arc Voltage	I=5A min	V_{ARC}	-	15	-	-	15	-	-	15	-	V
Life Ratings⁽¹⁾												
Surge Life	500A (10/1000 μ s)	-	1000	-	-	1000	-	-	1000	-	-	shots
Max Current Surge	10kA (8/20 μ s)	-	10	-	-	10	-	-	10	-	-	shots
AC Current	10x 1sec @ 60Hz	-	-	-	20	-	-	20	-	-	20	A
AC Follow-on Current	1/2 cycle @ 60Hz	-	-	-	20	-	-	20	-	-	20	A pk
DC Holdover Voltage	per REA PE-80, 0.2A	-	-	150	-	-	150	-	-	150	-	V

⁽¹⁾End-of-Life limits are:

DC: 50% of minimum initial DC breakdown voltage limit to 150% of maximum initial DC breakdown voltage limit

Impulse: less than 150% of initial Impulse breakdown voltage limit.

TWO ELECTRODE SURGE ARRESTERS

CG/CG2 Series

PERFORMANCE CHARACTERISTICS

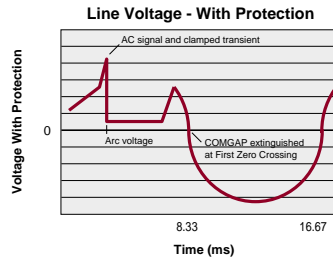
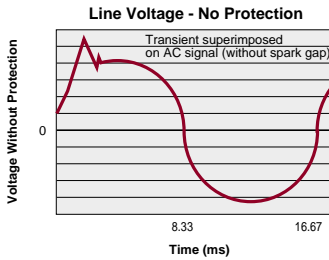
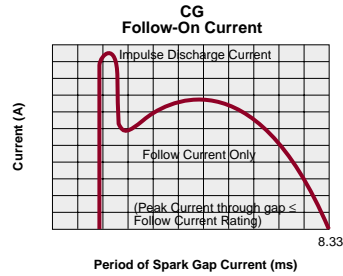
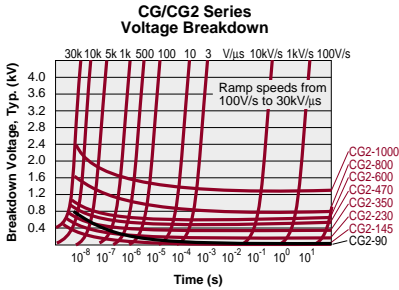

MECHANICAL DIMENSIONS

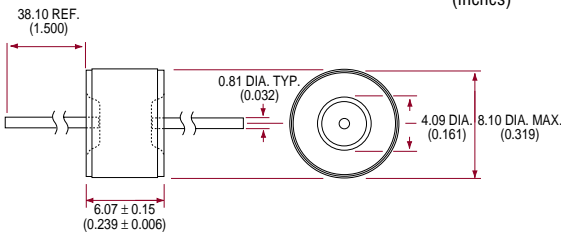

ORDERING INFORMATION

CG/CG2's with other breakdown voltages in the 75-1000 V range are available upon request. A complete part number is represented by the digits below. For example, CG75 is a non-leaded 75V device, CG2-230L is a leaded 230V device, and CG2-800LTR is a leaded 800V device on tape-and-reel per EIA standard RS-296-D.

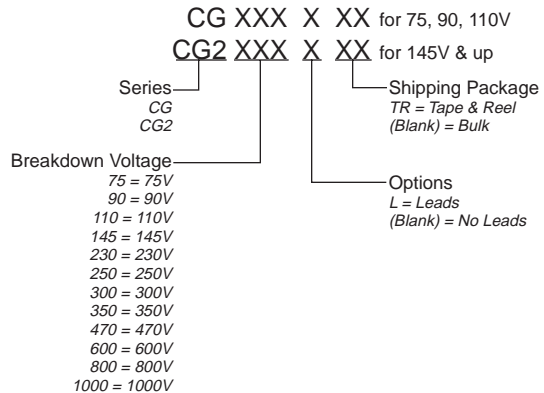



DESCRIPTION

CP Clare's two electrode non-radioactive CG/CG2 SN Comgaps are designed for use in surge protection applications for which the radioactive isotope used in the standard CG/CG2 Series (75-470V) is not desired. The gas-filled, rugged ceramic-metal construction of Comgaps makes them well suited to adverse environments. Comgaps function as switches which dissipate a minimum amount of energy and therefore handle currents that far surpass other types of transient voltage protection.

FEATURES

- Small size
- Rugged ceramic-metal construction
- Non-radioactive
- Low capacitance (<1pF)
- Available with or without leads
- Available in tape-and-reel packaging

APPLICATIONS

- Communication lines
- CATV equipment
- Test equipment
- Power supplies
- Medical electronics
- Instrumentation circuits

APPROVALS

- Meets REA PE-80
- Designed to meet CCITT-K12

RATINGS (@ 25° C)

Parameter	Min	Typ	Max	Units
DC Breakdown Voltage	72	90	108	V
	184	230	276	V
	200	250	300	V
	240	300	360	V
	280	350	420	V
	376	470	564	V
Insulation Resistance	10 ⁹	-	-	Ω
Capacitance	-	-	1	pF
Operational Temp	-40	-	+125	°C

(See detailed specifications for more information.)

TWO ELECTRODE NON-RADIOACTIVE SURGE ARRESTERS

CG/CG2 SN Series

SPECIFICATIONS

All characteristics at 25°C

PARAMETER	CONDITIONS	SYMBOL	CG90SN CG90LSN			CG2-230SN CG2-230LSN			CG2-250SN CG2-250LSN			UNITS
			MIN	TYP	MAX	MIN	TYP	MAX	MIN	TYP	MAX	
Device Specifications												
DC Breakdown	500V/s	V_{BD}	72	90	113	184	230	276	200	250	300	V
Impulse Breakdown	100V/ μ s	V_{bd}	-	-	500	-	-	600	-	-	600	V
Insulation Resistance	100V	IR	10^9	-	-	10^9	-	-	10^9	-	-	Ω
Capacitance	1MHz	C	-	-	1	-	-	1	-	-	1	pF
Arc Voltage	1=5A min	V_{ARC}	-	10	-	-	10	-	-	10	-	V
Life Ratings⁽¹⁾												
Surge Life	500A (10/1000 μ s)	-	400	-	-	400	-	-	400	-	-	shots
Max Current Surge	10kA (8/20 μ s)	-	10	-	-	10	-	-	10	-	-	shots
AC Current	10x 1sec @ 60Hz	-	-	-	20	-	-	20	-	-	20	A
AC Follow-on Current	$\frac{1}{2}$ cycle @ 60Hz	-	-	-	N/A	-	-	20	-	-	20	A pk
DC Holdover Voltage	per REA PE-80, 0.2A	-	-	65	-	-	150	-	-	150	-	V

PARAMETER	CONDITIONS	SYMBOL	CG2-300SN CG2-300LSN			CG2-350SN CG2-350LSN			CG2-470SN CG2-470LSN			UNITS
			MIN	TYP	MAX	MIN	TYP	MAX	MIN	TYP	MAX	
Device Specifications												
DC Breakdown	500V/s	V_{BD}	240	300	360	280	350	420	376	470	564	V
Impulse Breakdown	100V/ μ s	V_{bd}	-	-	700	-	-	750	-	-	850	V
Insulation Resistance	100V	IR	10^9	-	-	10^9	-	-	10^9	-	-	Ω
Capacitance	1MHz	C	-	-	1	-	-	1	-	-	1	pF
Arc Voltage	1=5A min	V_{ARC}	-	10	-	-	10	-	-	10	-	V
Life Ratings⁽¹⁾												
Surge Life	500A (10/1000 μ s)	-	400	-	-	400	-	-	400	-	-	shots
Max Current Surge	10kA (8/20 μ s)	-	10	-	-	10	-	-	10	-	-	shots
AC Current	10x 1sec @ 60Hz	-	-	-	20	-	-	20	-	-	20	A
AC Follow-on Current	$\frac{1}{2}$ cycle @ 60Hz	-	-	-	20	-	-	20	-	-	20	A pk
DC Holdover Voltage	per REA PE-80, 0.2A	-	-	150	-	-	150	-	-	150	-	V

⁽¹⁾End-of-life limits are:

DC: 50% of minimum initial DC breakdown voltage limit to 150% of maximum initial DC breakdown voltage limit.

Impulse: less than 150% of initial Impulse breakdown voltage limit.

MECHANICAL DIMENSIONS

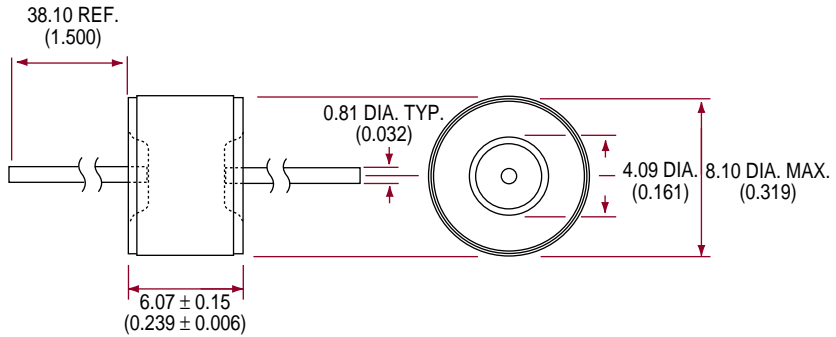

ORDERING INFORMATION

CG/CG2 SN's with other breakdown voltages in the 90-470 V range are available upon request. A complete part number is represented by the digits below. For example, CG2-230SN is a non-leaded 230V device, CG2-470LSN is a leaded 470V device, and CG90LSNTR is a leaded 90V device on tape-and-reel per EIA standard RS-296-D.

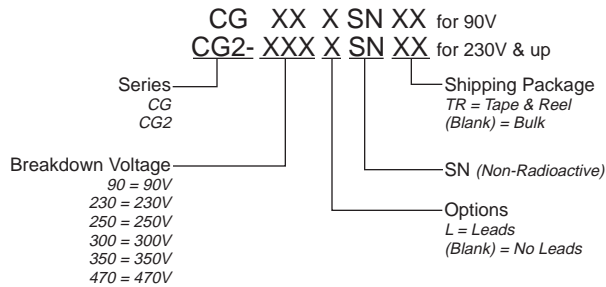

TWO ELECTRODE HIGH VOLTAGE SURGE ARRESTERS

CG3 Series



DESCRIPTION

CP Clare's two electrode high voltage CG3 Comgaps (1.0 - 8.5 kV) are designed for surge protection in applications for which bias voltages or signal levels of several hundred volts are normally present. Comgaps function as switches which dissipate a minimum amount of energy and therefore handle currents that far surpass other types of transient voltage protection.

FEATURES

- Small size
- Rugged ceramic-metal construction
- Non-radioactive
- Low capacitance (<1pF)
- Available in tape-and-reel packaging
- Available with or without leads

APPLICATIONS

- CRT terminal
- CATV equipment
- Antennas
- Power supplies
- Medical electronics

APPROVALS

- UL Recognized: File Number E111526
- UL Recognized: File Number E145934 (CG3XUHTZ only)
- CSA Approved: File Number LR89617

RATINGS (@ 25° C)

Parameter	Min	Typ	Max	Unit
DC Breakdown Voltage	800	1000	1200	V
	1200	1500	1800	V
	1600	2000	2400	V
	2000	2500	3000	V
	2400	3000	3600	V
	3200	4000	4800	V
	4000	5000	6000	V
	6000	7500	9000	V
	6800	8500	10200	V
	Insulation Resistance	10 ¹⁰	-	-
Capacitance	-	-	1	pF
Operational Temperature	-40	-	+125	°C

(See detailed specifications for more information.)

TWO ELECTRODE HIGH VOLTAGE SURGE ARRESTERS

CG3 Series

SPECIFICATIONS

All characteristics at 25°C

CG3-1.0
CG3-1.0L

CG3-1.5
CG3-1.5L

PARAMETER	CONDITIONS	SYMBOL	MIN	TYP	MAX	MIN	TYP	MAX	UNITS
Device Specifications									
DC Breakdown	500V/s	V_{BD}	800	1000	1200	1200	1500	1800	V
Impulse Breakdown	100V/ μ s	V_{bd}	-	-	1500	-	-	2200	V
Insulation Resistance	100V	IR	10^{10}	-	-	10^{10}	-	-	Ω
Capacitance	1MHz	C	-	-	1	-	-	1	pF
Arc Voltage	I=5A min	V_{ARC}	-	10	-	-	10	-	V
Mechanical Outline		-	-	A	-	-	A	-	-
Life Ratings⁽¹⁾									
Surge Life	.002mF, 100 Ω	-	500	-	-	500	-	-	shots
Max Current Surge	10kA (8/20 μ s)	-	5	-	-	5	-	-	shots
AC Follow-on Current	1/2 cycle @ 60Hz	-	-	-	300	-	-	300	A pk

CG3-2.0
CG3-2.0L

CG3-2.5
CG3-2.5L

PARAMETER	CONDITIONS	SYMBOL	MIN	TYP	MAX	MIN	TYP	MAX	UNITS
Device Specifications									
DC Breakdown	500V/s	V_{BD}	1600	2000	2400	2000	2500	3000	V
Impulse Breakdown	100V/ μ s	V_{bd}	-	-	3000	-	-	3750	V
Insulation Resistance	100V	IR	10^{10}	-	-	10^{10}	-	-	Ω
Capacitance	1MHz	C	-	-	1	-	-	1	pF
Arc Voltage	I=5A min	V_{ARC}	-	10	-	-	10	-	V
Mechanical Outline		-	-	A	-	-	A	-	-
Life Ratings⁽¹⁾									
Surge Life	.002mF, 100 Ω	-	500	-	-	500	-	-	shots
Max Current Surge	10kA (8/20 μ s)	-	5	-	-	5	-	-	shots
AC Follow-on Current	1/2 cycle @ 60Hz	-	-	-	300	-	-	300	A pk

CG3-3.0
CG3-3.0L

CG3-4.0
CG3-4.0L

PARAMETER	CONDITIONS	SYMBOL	MIN	TYP	MAX	MIN	TYP	MAX	UNITS
Device Specifications									
DC Breakdown	500V/s	V_{BD}	2400	3000	3600	3200	4000	4800	V
Impulse Breakdown	100V/ μ s	V_{bd}	-	-	4500	-	-	6000	V
Insulation Resistance	100V	IR	10^{10}	-	-	10^{10}	-	-	Ω
Capacitance	1MHz	C	-	-	1	-	-	1	pF
Arc Voltage	I=5A min	V_{ARC}	-	10	-	-	10	-	V
Mechanical Outline		-	-	B	-	-	B	-	-
Life Ratings⁽¹⁾									
Surge Life	.002mF, 100W	-	500	-	-	500	-	-	shots
Max Current Surge	10kA (8/20 μ s)	-	5	-	-	5	-	-	shots
AC Follow-on Current	1/2 cycle @ 60Hz	-	-	-	300	-	-	300	A pk

⁽¹⁾End-of-life limits are:

DC: 50% of minimum initial DC breakdown voltage limit to 150% of maximum initial DC breakdown voltage limit.

Impulse: less than 150% of initial impulse breakdown voltage limit.

TWO ELECTRODE HIGH VOLTAGE SURGE ARRESTERS

CG3 Series

SPECIFICATIONS

All characteristics at 25°C

PARAMETER	CONDITIONS	SYMBOL	CG3-5.0 CG3-5.0L			CG3-7.5 CG3-7.5L			CG3-8.5 CG3-8.5L			UNITS
			MIN	TYP	MAX	MIN	TYP	MAX	MIN	TYP	MAX	
Device Specifications												
DC Breakdown	500V/s	V_{BD}	4000	5000	6000	6000	7500	9000	6800	8500	10200	V
Impulse Breakdown	100V/ μ s	V_{bd}	-	-	7500	-	-	10000	-	-	13500	V
Insulation Resistance	100V	IR	10^{10}	-	-	10^{10}	-	-	10^{10}	-	-	Ω
Capacitance	1MHz	C	-	-	1	-	-	1	-	-	1	pF
Arc Voltage	I=5A min	V_{ARC}	-	10	-	-	10	-	-	10	-	V
Mechanical Outline		-	-	B	-	-	B	-	-	B	-	-
Life Ratings⁽¹⁾												
Surge Life	.002mF, 100 Ω	-	500	-	-	500	-	-	500	-	-	shots
Max Current Surge	10kA (8/20 μ s)	-	5	-	-	5	-	-	5	-	-	shots
AC Follow-on Current	$1/2$ cycle @ 60Hz	-	-	-	300	-	-	300	-	-	300	A pk

⁽¹⁾End-of-life limits are:

DC: 50% of minimum initial DC breakdown voltage limit to 150% of maximum initial DC breakdown voltage limit.

Impulse: less than 150% of initial impulse breakdown voltage limit.

MECHANICAL DIMENSIONS

Outline A

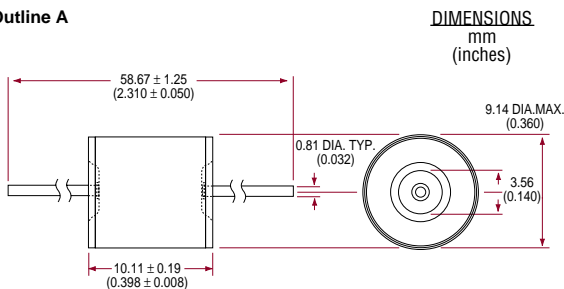

Outline B

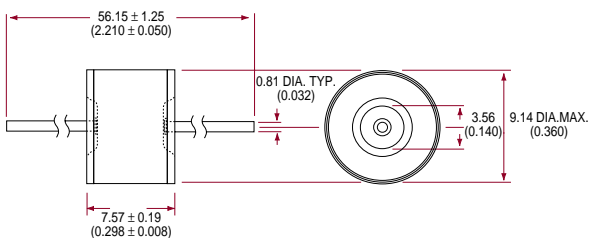

ORDERING INFORMATION

CG3's with other breakdown voltages in the 1.0-8.5kV range are available upon request. A complete part number is represented by the digits below. For example, CG3-1.5 is a non-leaded 1500V device, CG3-5.0L is a leaded 5000V device, and CG3-7.5LTR is a leaded 7500V device on tape-and-reel per EIA standard RS-296-D.

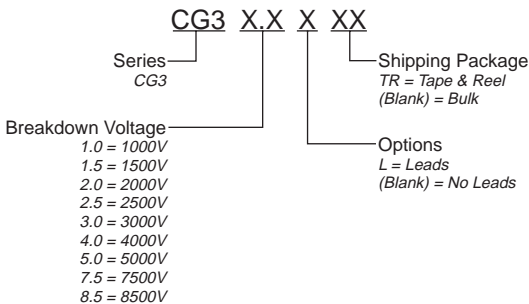



DESCRIPTION

CP Clare's two electrode mini CG5 Comgaps are gas filled, non-radioactive surge protectors. These devices are physically smaller than Clare's standard CG/CG2 series reducing the space required to provide high performance circuit protection. The CG5 series can be supplied with or without leads. These components are used in a variety of different applications, including telecom and CATV communication lines. The small CG5 gas tubes function as switches which dissipate a minimum amount of energy and therefore handle currents that far surpass other types of transient voltage protection.

FEATURES

- Smallest CG device
- Non-radioactive
- Rugged ceramic-metal construction
- Low capacitance (<1pF)
- Available with or without leads
- Available in tape-and-reel packaging

APPLICATIONS

- Telecom lines
- CATV equipment
- Test equipment
- Data lines
- Instrumentation circuits

RATINGS (@ 25° C)

Parameter	Min	Typ	Max	Units
DC Breakdown Voltage	72	90	113	V
	184	230	276	V
	280	350	420	V
Insulation Resistance	10 ¹⁰	-	-	Ω
Capacitance	-	-	1	pF
Operational Temperature	-40	-	+125	°C

(See detailed specifications for more information.)

TWO ELECTRODE MINI SURGE ARRESTERS

CG5 Series

SPECIFICATIONS

All characteristics at 25°C

PARAMETERS	CONDITIONS	SYMBOL	CG5-90 CG5-90L			CG5-230 CG5-230L			CG5-350 CG5-350L			UNITS
			MIN	TYP	MAX	MIN	TYP	MAX	MIN	TYP	MAX	
Device Specifications												
DC Breakdown	500V/s	V_{BD}	72	90	113	184	230	276	280	350	420	V
Impulse Breakdown	100V/ μ s	V_{bd}	-	-	500	-	-	500	-	-	600	V
	1kV/ μ s	V_{bd}	-	-	700	-	-	700	-	-	800	V
Insulation Resistance	50V	IR	10^{10}	-	-	10^{10}	-	-	10^{10}	-	-	Ω
Capacitance	1MHz	C	-	-	1	-	-	1	-	-	1	pF
Arc Voltage	I=5A min	V_{ARC}	-	25	-	-	25	-	-	25	-	V
Life Ratings⁽¹⁾												
Surge Life	100A (10/1000 μ s)	-	300	-	-	300	-	-	300	-	-	shots
Max Current Surge	5kA (8/20 μ s)	-	10	-	-	10	-	-	10	-	-	shots
AC Current	10x 1sec @ 60Hz	-	-	-	5	-	-	5	-	-	5	A

⁽¹⁾ End-of-Life limits are:

DC: 50% of minimum initial DC Breakdown Voltage limit to 150% of maximum initial DC Breakdown Voltage limit.
Impulse: less than 150% of initial impulse Breakdown Voltage limit.

MECHANICAL DIMENSIONS

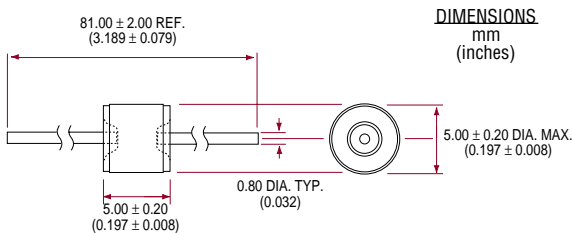

ORDERING INFORMATION

A complete part number is represented by the digits below. For example, CG5-90 is a non-leaded 90V device, CG5-230L is a leaded 230V device, and CG5-350LTR is a leaded 350V device on tape-and-reel per EIA standard RS-296-D.

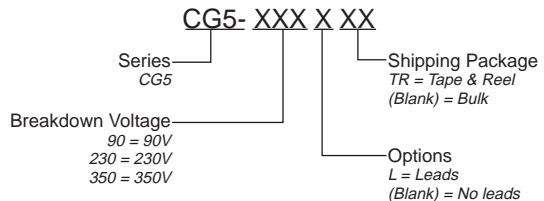



DESCRIPTION

CP Clare's two electrode CG820 Comgaps are gas-filled, non-radioactive surge protectors. These devices are similar in construction to our other two electrode devices; however, they are 8mm in diameter and 20mm in length, making them suitable for mounting in standard holders. These devices are used in a variety of applications, including protection of telecom and CATV communications lines. CG820 gas tubes function as switches and therefore handle currents that far surpass other types of transient protection.

FEATURES

- Standard 8mm x 20mm Package
- Non-Radioactive
- Rugged Ceramic Metal Construction
- Low Capacitance (<1.5 pF)
- 20kA Surge Current Capability

APPLICATIONS

- Telecom Lines
- CATV Equipment
- Test Equipment
- Data Lines
- Instrumentation Circuits
- Power Supplies

RATINGS (@ 25° C)

Parameters	Min	Typ	Max	Units
DC Breakdown	73	90	113	V
	184	230	276	V
	280	350	420	V
Insulation Resistance	10 ¹⁰	–	–	Ω
Capacitance	–	–	1.5	pF
Operational Temperature	-40	–	+125	°C

(See detailed specifications for more information)

HEAVY DUTY SURGE ARRESTERS

CG820 Series

SPECIFICATIONS

PARAMETERS	CONDITIONS	SYMBOL	CG820-090			CG820-230			UNITS
			MIN	TYP	MAX	MIN	TYP	MAX	
Device Specifications									
DC Breakdown	100V/s	V_{BD}	72	90	113	185	230	276	V
Impulse Breakdown	1k V/ μ s	V_{bd}	-	600	800	-	600	800	V
Insulation Resistance	50V (-090) 100V (-230)	IR	10^{10}	-	-	10^{10}	-	-	Ω
Capacitance	1MHz	C	-	-	1.5	-	-	1.5	pF
Arc Voltage	I=0.5A min (-230) I=1.0A min (-090)	V_{ARC}	-	15	-	-	15	-	V
Life Ratings⁽¹⁾									
Surge Life	100A (10/1000 μ s)	-	300	-	-	300	-	-	Shots
Max Current Rating	20ka (8/20 μ s)	-	10	-	-	10	-	-	Shots
AC Current	10x 1sec @ 60Hz	-	-	-	20	-	-	20	A

PARAMETERS	CONDITIONS	SYMBOL	CG820-350			CG820-230-01 ⁽²⁾			UNITS
			MIN	TYP	MAX	MIN	TYP	MAX	
Device Specifications									
DC Breakdown	100V/s	V_{BD}	280	350	420	185	230	287	V
Impulse Breakdown	1k V/ μ s	V_{bd}	-	700	900	-	600	800	V
Insulation Resistance	100V	IR	10^{10}	-	-	10^{10}	-	-	Ω
Capacitance	1MHz	C	-	-	1.5	-	-	1.5	pF
Arc Voltage	I=0.5A min	V_{ARC}	-	15	-	-	15	-	V
Life Ratings⁽¹⁾									
Surge Life	100A (10/1000 μ s)	-	300	-	-	300	-	-	Shots
Max Current Rating	20ka (8/20 μ s)	-	10	-	-	10	-	-	Shots
AC Current	10x 1sec @ 60Hz	-	-	-	20	-	-	20	A

⁽¹⁾ End of life limits are: DC: 50% of minimum initial DC Breakdown Voltage limit to 150% of maximum initial DC Breakdown Voltage limit. Impulse: Less than 150% of Initial Impulse Breakdown Voltage limit.

⁽²⁾ Meets DTAG qualification FTZ 477716301, Form-F.

MECHANICAL DIMENSIONS

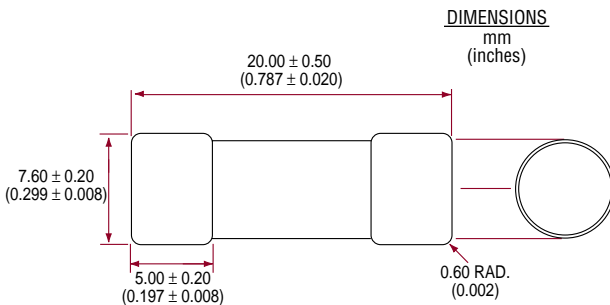

ORDERING INFORMATION

A complete part number is represented by the digits below. For example, CG820-090 represents a device with a 90V nominal breakdown voltage.

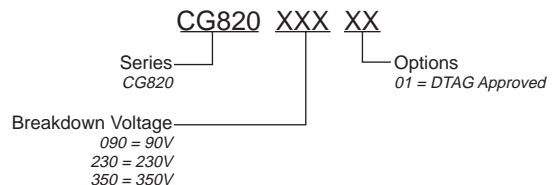



DESCRIPTION

Clare's three electrode PMT3(310) Comgaps are designed for a high degree of surge protection at a low cost. This series (150-500V) is primarily used for the protection of telecommunications equipment in which simultaneous crowbar action of two signal lines is required. Comgaps function as switches which dissipate a minimum amount of energy and therefore handle currents that far surpass other types of transient voltage protection.

FEATURES

- Small size
- Rugged ceramic-metal construction
- Low capacitance (<1 pF)
- Available with fail-safe clip
- Available with or without leads
- Available with various lead spacings
- Available in tube packaging

APPLICATIONS

- Telephone interface
- Telephone line cards
- Repeaters
- Modems
- Line test equipment

APPROVALS

- UL Recognized: File Number E145795
- REA PE-80

RATINGS (@ 25° C)

Parameter	Min	Typ	Max	Units
DC Breakdown Voltage (line - ground)	120	150	180	V
	184	230	276	V
	200	250	300	V
	280	350	420	V
	320	400	480	V
	400	500	600	V
Insulation Resistance	10 ¹⁰	-	-	Ω
Capacitance (line - ground)	-	-	1	pF
Capacitance (line - line)	-	-	0.5	pF
Operational Temperature	-40	-	+125	°C

(See detailed specifications for more information.)

THREE ELECTRODE SURGE ARRESTERS

PMT3(310) Series

SPECIFICATIONS

All characteristics at 25°C

PARAMETER	CONDITIONS	SYMBOL	PMT3(310) 150XX			PMT3(310) 230XX			PMT3(310) 250XX			UNITS
			MIN	TYP	MAX	MIN	TYP	MAX	MIN	TYP	MAX	
Device Specifications												
DC Breakdown (I-g)	500V/s	$V_{BD(I-g)}$	120	150	180	184	230	276	200	250	300	V
DC Breakdown (I-I)	500V/s	$V_{BD(I-I)}$	-	-	360	-	-	552	-	-	600	V
Impulse Breakdown(I-g)	100V/ μ s	V_{bd}	-	-	500	-	-	600	-	-	600	V
Insulation Resistance	100V	IR	10^{10}	-	-	10^{10}	-	-	10^{10}	-	-	Ω
Capacitance (I-g)	1MHz	$C_{(I-g)}$	-	-	1	-	-	1	-	-	1	pF
Capacitance (I-I)	1MHz	$C_{(I-I)}$	-	-	0.5	-	-	0.5	-	-	0.5	pF
Arc Voltage	1= 5A min	V_{ARC}	-	16	-	-	16	-	-	16	-	V
Life Ratings⁽¹⁾												
Surge Life	500A (10/1000 μ s)		400	-	-	400	-	-	400	-	-	shots
Max Current Surge	10kA + 10kA (8/20 μ s)		10	-	-	10	-	-	10	-	-	shots
AC Current	11 cycles @ 60Hz		-	N/A	-	-	-	65+65	-	-	65+65	A
AC Follow-on Current	1/2 cycle @ 60Hz		-	N/A	-	-	-	20	-	-	20	A pk

PARAMETER	CONDITIONS	SYMBOL	PMT3(310) 350XX			PMT3(310) 400XX			PMT3(310) 500XX			UNITS
			MIN	TYP	MAX	MIN	TYP	MAX	MIN	TYP	MAX	
Device Specifications												
DC Breakdown (I-g)	500V/s	$V_{BD(I-g)}$	280	350	420	320	400	480	400	500	600	V
DC Breakdown (I-I)	500V/s	$V_{BD(I-I)}$	-	-	800	-	-	1000	-	-	1200	V
Impulse Breakdown(I-g)	100V/ μ s	V_{bd}	-	-	750	-	-	750	-	-	850	V
Insulation Resistance	100V	IR	10^{10}	-	-	10^{10}	-	-	10^{10}	-	-	Ω
Capacitance (I-g)	1MHz	$C_{(I-g)}$	-	-	1	-	-	1	-	-	1	pF
Capacitance (I-I)	1MHz	$C_{(I-I)}$	-	-	0.5	-	-	0.5	-	-	0.5	pF
Arc Voltage	1=5A min	V_{ARC}	-	16	-	-	16	-	-	16	-	V
Life Ratings⁽¹⁾												
Surge Life	500A (10/1000 μ s)		400	-	-	400	-	-	400	-	-	shots
Max Current Surge	10kA + 10kA (8/20 μ s)		10	-	-	10	-	-	10	-	-	shots
AC Current	11 cycles @ 60Hz		-	-	65+65	-	-	65+65	-	-	65+65	A
AC Follow-on Current	1/2 cycle @ 60Hz		-	-	20	-	-	20	-	-	20	A pk

⁽¹⁾End-of-life limits are:

DC: 50% of minimum initial DC breakdown voltage limit to 150% of maximum initial DC breakdown voltage limit.

Impulse: less than 150% of initial impulse breakdown voltage limit.

MECHANICAL DIMENSIONS

DIMENSIONS
mm
(inches)

01 Outline

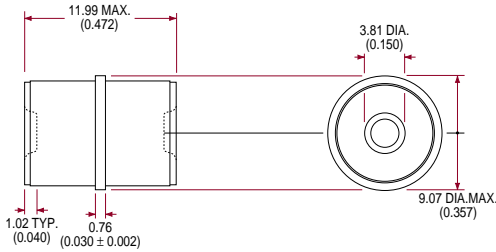

04 Outline

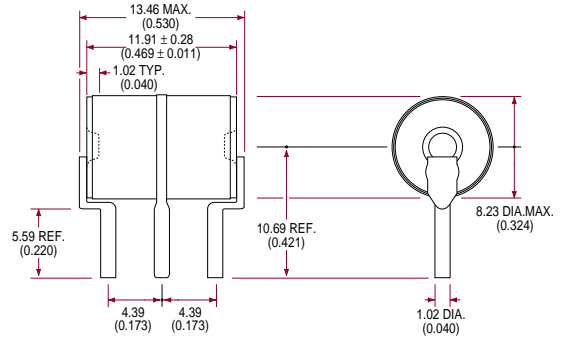

06 Outline

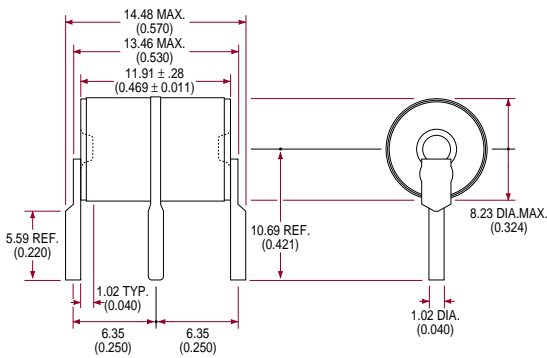

10 Outline

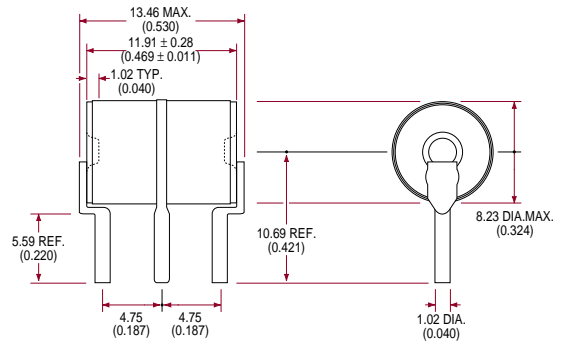

Note: Lead space tolerance is ± 0.13 (0.005)

ORDERING INFORMATION

PMT3(310)'s with other breakdown voltages in the 75-500V range are available upon request. A complete part number is represented by the digits below. For example, PMT3(310)25010 is a 250V device with outline #10 (pins on 4.75 mm centers). Parts are packed in tubes.

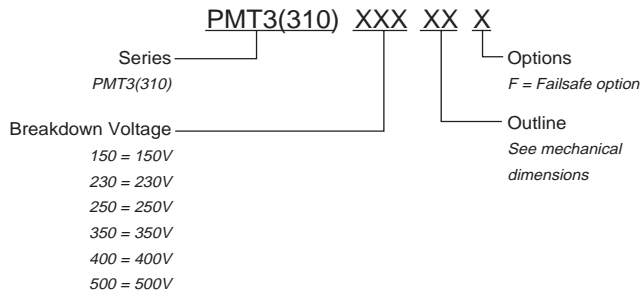

THREE ELECTRODE NON-RADIOACTIVE SURGE ARRESTERS

PMT8 Series



DESCRIPTION

CP Clare's three electrode non-radioactive PMT8 Comgaps are telecom grade gas-filled surge arresters. These devices are designed to meet the recommendations in CCITT-K12 and Bellcore GR-1361-CORE. The three electrode configuration is used in applications where simultaneous crowbar action of two signal lines is required. These components can be supplied with a fail-safe clip and are available with or without leads. PMT8 gas tubes function as switches which dissipate a minimum amount of energy and therefore handle currents that far surpass other types of transient voltage protection.

FEATURES

- Telecom grade (CCITT-K12)
- Non-radioactive
- Rugged ceramic-metal construction
- Low capacitance (<1pF)
- Available with fail-safe clip
- Available with or without leads
- Various lead configurations
- Available in tube packaging

APPLICATIONS

- Telecom network interfaces
- Telephone line cards
- Repeaters
- Modems
- Line test equipment

APPROVALS

- Designed to meet CCITT-K12

RATINGS (@ 25° C)

Parameter	Min	Typ	Max	Units
DC Breakdown Voltage (line - ground)	72	90	113	V
	184	230	276	V
	280	350	420	V
Insulation Resistance	10 ¹⁰	-	-	Ω
Capacitance (line - ground)	-	-	1	pF
Capacitance (line - line)	-	-	0.5	pF
Operational Temperature	-40	-	+125	°C

(See detailed specifications for more information.)

THREE ELECTRODE NON-RADIOACTIVE SURGE ARRESTERS

PMT8 Series

SPECIFICATIONS

All characteristics at 25°C

PARAMETERS	CONDITIONS	SYMBOL	PMT8-090XX			PMT8-230XX			PMT8-350XX			UNITS
			MIN	TYP	MAX	MIN	TYP	MAX	MIN	TYP	MAX	
Device Specifications												
DC Breakdown (I-g)	500V/s	$V_{BD(I-g)}$	72	90	113	184	230	276	280	350	420	V
DC Breakdown (I-I)	500V/s	$V_{BD(I-I)}$	-	-	216	-	-	552	-	-	840	V
Impulse Breakdown (I-g)	100V/ μ s	V_{bd}	-	-	500	-	-	500	-	-	600	V
	1kV/ μ s	V_{bd}^{bd}	-	-	800	-	-	800	-	-	900	V
Insulation Resistance	100V	IR	10^{10}	-	-	10^{10}	-	-	10^{10}	-	-	Ω
Capacitance (I-g)	1MHz	$C^{(I-g)}$	-	-	1	-	-	1	-	-	1	pF
Capacitance (I-I)	1MHz	$C^{(I-I)}$	-	-	0.5	-	-	0.5	-	-	0.5	pF
Arc Voltage	I=5A min	V_{ARC}	-	25	-	-	25	-	-	25	-	V
Life Ratings⁽¹⁾												
Surge Life	100A (10/1000 μ s)		300	-	-	300	-	-	300	-	-	shots
Max Current Surge	10kA+10kA (8/20 μ s)		10	-	-	10	-	-	10	-	-	shots
AC Current	10x Isec @ 60Hz		-	-	10	-	-	10	-	-	10	A

⁽¹⁾End-of-Life limits are:

DC: 50% of minimum initial DC Breakdown Voltage limit to 150% of maximum initial DC Breakdown Voltage limit

Impulse: less than 150% of initial Impulse Breakdown Voltage limit.

MECHANICAL DIMENSIONS

DIMENSIONS
mm
(inches)

01 Outline

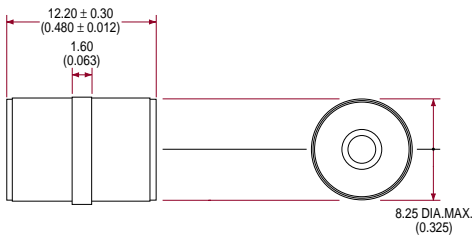

04 Outline

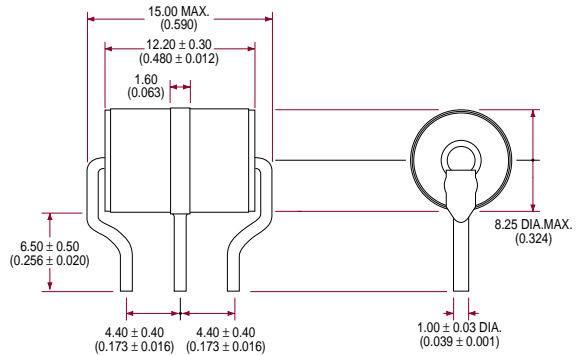

04 Outline with fail-safe clip

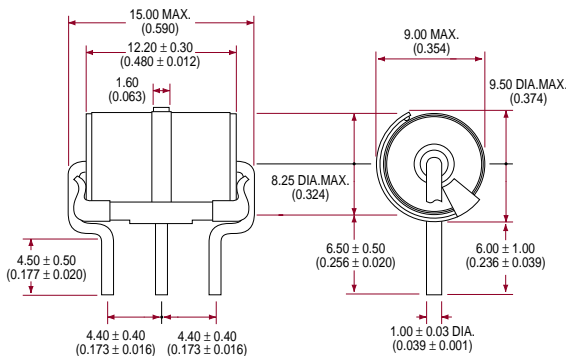

ORDERING INFORMATION

A complete part number is represented by the digits below. For example, PMT8-09004F is a 90V device with mechanical outline 04 and a fail-safe clip. Parts are packed in tubes.

PMT8- XXX XX X

Series
PMT8

Breakdown Voltage
090 = 90V
230 = 230V
350 = 350V

Options
F = Fail-safe option

Outline
See mechanical dimensions

High Energy Devices



CP Clare's High Energy Devices are used to protect electrical equipment from damaging voltage transients or to create a high energy voltage discharge within an electrical circuit. High Energy Devices are made from the highest quality materials to reliably handle extremely high operating voltage and current applications. These products are used extensively in some of the most demanding military environments and are typically used

for protecting thyatron or hard tube modulator components, high-wattage power supply components, high voltage medical equipment, and video display tubes. These devices are also used as active switches for high voltage energy transfer or triggering applications such as flashtubes, exploding bridgewire systems (EBW), and capacitor bank discharging.



DESCRIPTION

CP Clare's PMT(275) and UMT(275) Series surge protectors (350-500V and 550-2500V respectively) provide a high level of protection from high-speed, high-current transient surges. These devices are constructed using a proprietary semiconductor junction process which results in nanosecond response times combined with peak current ratings in excess of 20kA.

FEATURES

- Fast impulse breakdown ($\leq 125\%$ of typical DC breakdown at $5\text{kV}/\mu\text{s}$)
- Tight DC breakdown voltage tolerance ($\pm 10\%$)
- Low capacitance

APPLICATIONS

- Test equipment
- Video displays
- Medical electronics
- Instrumentation circuits

STANDARD VOLTAGES

Series	DC Breakdown Voltage (typ)	Unit
PMT(275)	350	V
	400	V
	450	V
	500	V
UMT(275)	550	V
	600	V
	650	V
	750	V
	800	V
	850	V
	1.0	kV
	1.5	kV
	2.0	kV
2.5	kV	

(See detailed specifications for more information.)

HIGH-SPEED, HIGH-CURRENT SURGE PROTECTORS

PMT/UMT (275) Series

SPECIFICATIONS

All characteristics at 25°C

PARAMETER	CONDITIONS	SYMBOL	PMT(275)350			PMT(275)400			UNITS
			MIN	TYP	MAX	MIN	TYP	MAX	
Device Specifications									
DC Breakdown	100V/s	V_{BD}	315	350	385	360	400	440	V
Impulse Breakdown	5kV/ μ s	V_{bd}	-	-	750	-	-	750	V
Insulation Resistance	100V	IR	10^{10}	-	-	10^{10}	-	-	Ω
Capacitance	1MHz	C	-	-	4	-	-	4	pF
Life Ratings									
Surge Life	1kA (PW=20 μ s)		500	-	-	500	-	-	surges

PARAMETER	CONDITIONS	SYMBOL	PMT(275)450			PMT(275)500			UNITS
			MIN	TYP	MAX	MIN	TYP	MAX	
Device Specifications									
DC Breakdown	100V/s	V_{BD}	405	450	495	450	500	550	V
Impulse Breakdown	5kV/ μ s	V_{bd}	-	-	750	-	-	750	V
Insulation Resistance	100V	IR	10^{10}	-	-	10^{10}	-	-	Ω
Capacitance	1MHz	C	-	-	4	-	-	4	pF
Life Ratings									
Surge Life	1kA (PW=20 μ s)		500	-	-	500	-	-	surges

PARAMETER	CONDITIONS	SYMBOL	UMT(275)550			UMT(275)600			UNITS
			MIN	TYP	MAX	MIN	TYP	MAX	
Device Specifications									
DC Breakdown	100V/s	V_{BD}	495	550	605	540	600	660	V
Impulse Breakdown	5kV/ μ s	V_{bd}	-	-	688	-	-	750	V
Insulation Resistance	100V	IR	10^{10}	-	-	10^{10}	-	-	Ω
Capacitance	1MHz	C	-	-	4	-	-	4	pF
Life Ratings									
Surge Life	1kA (PW=20 μ s)		500	-	-	500	-	-	surges

PARAMETER	CONDITIONS	SYMBOL	UMT(275)650			UMT(275)750			UNITS
			MIN	TYP	MAX	MIN	TYP	MAX	
Device Specifications									
DC Breakdown	100V/s	V_{BD}	585	650	715	675	750	825	V
Impulse Breakdown	5kV/ μ s	V_{bd}	-	-	813	-	-	938	V
Insulation Resistance	100V	IR	10^{10}	-	-	10^{10}	-	-	Ω
Capacitance	1MHz	C	-	-	4	-	-	4	pF
Life Ratings									
Surge Life	1kA (PW=20 μ s)		500	-	-	500	-	-	surges

PARAMETER	CONDITIONS	SYMBOL	UMT(275)800			UMT(275)850			UNITS
			MIN	TYP	MAX	MIN	TYP	MAX	
Device Specifications									
DC Breakdown	100V/s	V_{BD}	720	800	880	765	850	935	V
Impulse Breakdown	5kV/ μ s	V_{bd}	-	-	1000	-	-	1063	V
Insulation Resistance	100V	IR	10^{10}	-	-	10^{10}	-	-	Ω
Capacitance	1MHz	C	-	-	4	-	-	4	pF
Life Ratings									
Surge Life	1kA (PW=20 μ s)		500	-	-	500	-	-	surges

SPECIFICATIONS

All characteristics at 25°C

PARAMETER	CONDITIONS	SYMBOL	UMT(275)1.0			UMT(275)1.5			UNITS
			MIN	TYP	MAX	MIN	TYP	MAX	
Device Specifications									
DC Breakdown	100V/s	V_{BD}	0.9	1.0	1.1	1.35	1.50	1.65	kV
Impulse Breakdown	5kV/ μ s	V_{bd}	-	-	1.25	-	-	1.88	kV
Insulation Resistance	100V	IR	10^{10}	-	-	10^{10}	-	-	Ω
Capacitance	1MHz	C	-	-	4	-	-	4	pF
Life Ratings									
Surge Life	1kA (PW=20 μ s)	-	500	-	-	500	-	-	surges

PARAMETER	CONDITIONS	SYMBOL	UMT(275)2.0			UMT(275)2.5			UNITS
			MIN	TYP	MAX	MIN	TYP	MAX	
Device Specifications									
DC Breakdown	100V/s	V_{BD}	1.8	2.0	2.2	2.25	2.50	2.75	kV
Impulse Breakdown	5kV/ μ s	V_{bd}	-	-	2.5	-	-	3.13	kV
Insulation Resistance	100V	IR	10^{10}	-	-	10^{10}	-	-	Ω
Capacitance	1MHz	C	-	-	4	-	-	4	pF
Life Ratings									
Surge Life	1kA (PW=20 μ s)	-	500	-	-	500	-	-	surges

MECHANICAL DIMENSIONS

DIMENSIONS
mm
(inches)

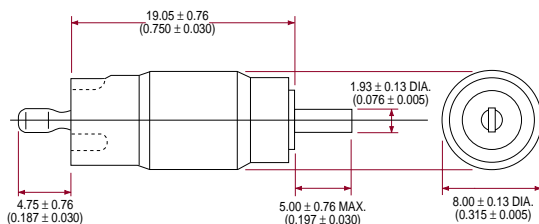

ORDERING INFORMATION

Devices in the PMT/UMT(275) series with other breakdown voltages in the 350-2500V range are available upon request.

A complete part number is represented by the digits below. Breakdown voltages are expressed in Volts for devices <1000V and kV for devices \geq 1kV. For example, PMT(275)350 is a 350V PMT(275) series device, and UMT(275)2.0 is a 2kV UMT(275) series device.

PMT(275)	XXX	for 350-500 V
UMT(275)	XXX	for 550-850 V
UMT(275)	X.X	for 1.0-2.5 kV

Series ——— Breakdown Voltage
PMT(275) ——— See specification tables
UMT(275)

PMT(301) Series



DESCRIPTION

CP Clare's PMT(301) Series surge protectors (350-3500V) provide a high level of protection from high-speed, high-current transient surges. These devices are constructed using a proprietary semiconductor junction process, which results in nanosecond response times combined with peak current ratings in excess of 10kA.

FEATURES

- Fast impulse breakdown
- Tight DC breakdown voltage tolerance ($\pm 10\%$)
- Rugged ceramic-metal construction
- Low capacitance

APPLICATIONS

- Test equipment
- Medical electronics
- Instrumentation circuits
- TWT drive circuitry
- Avionics

STANDARD VOLTAGES

Series	DC Breakdown Voltage (typ)	Unit
PMT(301)	350	V
	400	V
	500	V
	550	V
	600	V
	800	V
	1.0	kV
	1.5	kV
	2.0	kV
	2.5	kV
	3.0	kV
	3.5	kV

(See detailed specifications for more information.)

TWO ELECTRODE HIGH VOLTAGE SURGE ARRESTERS

PMT(301) Series

SPECIFICATIONS

All characteristics at 25°C

PMT(301)350

PMT(301)400

PARAMETER	CONDITIONS	SYMBOL	MIN	TYP	MAX	MIN	TYP	MAX	UNITS
Device Specifications									
DC Breakdown	100V/s	V_{BD}	315	350	385	360	400	440	V
Impulse Breakdown	80kV/ μ s	V_{bd}	-	-	1150	-	-	1200	V
Insulation Resistance	100V	IR	10^{10}	-	-	10^{10}	-	-	Ω
Capacitance	1MHz	C	-	-	4.0	-	-	4.0	pF
Life Ratings									
Surge Life	100A (PW=20 μ s)	-	6000	-	-	6500	-	-	surges

PMT(301)500

PMT(301)550

PARAMETER	CONDITIONS	SYMBOL	MIN	TYP	MAX	MIN	TYP	MAX	UNITS
Device Specifications									
DC Breakdown	100V/s	V_{BD}	450	500	550	495	550	605	V
Impulse Breakdown	80kV/ μ s	V_{bd}	-	-	1300	-	-	1350	V
Insulation Resistance	100V	IR	10^{10}	-	-	10^{10}	-	-	Ω
Capacitance	1MHz	C	-	-	4.0	-	-	4.0	pF
Life Ratings									
Surge Life	100A (PW=20 μ s)	-	7800	-	-	8500	-	-	surges

PMT(301)600

PMT(301)800

PARAMETER	CONDITIONS	SYMBOL	MIN	TYP	MAX	MIN	TYP	MAX	UNITS
Device Specifications									
DC Breakdown	100V/s	V_{BD}	540	600	660	720	800	880	V
Impulse Breakdown	80kV/ μ s	V_{bd}	-	-	1400	-	-	1600	V
Insulation Resistance	100V	IR	10^{10}	-	-	10^{10}	-	-	Ω
Capacitance	1MHz	C	-	-	4.0	-	-	4.0	pF
Life Ratings									
Surge Life	100A (PW=20 μ s)	-	9300	-	-	16600	-	-	surges

PMT(301)1.0

PMT(301)1.5

PARAMETER	CONDITIONS	SYMBOL	MIN	TYP	MAX	MIN	TYP	MAX	UNITS
Device Specifications									
DC Breakdown	100V/s	V_{BD}	0.9	1.0	1.1	1.35	1.50	1.65	kV
Impulse Breakdown	80kV/ μ s	V_{bd}	-	-	1.8	-	-	2.3	kV
Insulation Resistance	100V	IR	10^{10}	-	-	10^{10}	-	-	Ω
Capacitance	1MHz	C	-	-	4.0	-	-	4.0	pF
Life Ratings									
Surge Life	100A (PW=20 μ s)	-	29300	-	-	53700	-	-	surges

TWO ELECTRODE HIGH VOLTAGE SURGE ARRESTERS

PMT(301) Series

SPECIFICATIONS

All characteristics at 25°C

PARAMETER	CONDITIONS	SYMBOL	PMT(301)2.0			PMT(301)2.5			UNITS
			MIN	TYP	MAX	MIN	TYP	MAX	
Device Specifications									
DC Breakdown	100V/s	V_{BD}	1.8	2.0	2.2	2.25	2.5	2.75	kV
Impulse Breakdown	80kV/ μ s	V_{bd}	-	-	2.55	-	-	3.19	kV
Insulation Resistance	100V	IR	10^{10}	-	-	10^{10}	-	-	Ω
Capacitance	1MHz	C	-	-	4.0	-	-	4.0	pF
Life Ratings									
Surge Life	100A (PW=20 μ s)	-	68100	-	-	68100	-	-	surges

PARAMETER	CONDITIONS	SYMBOL	PMT(301)3.0			PMT(301)3.5			UNITS
			MIN	TYP	MAX	MIN	TYP	MAX	
Device Specifications									
DC Breakdown	100V/s	V_{BD}	2.7	3.0	3.3	3.15	3.5	3.85	kV
Impulse Breakdown	80kV/ μ s	V_{bd}	-	-	3.83	-	-	4.47	kV
Insulation Resistance	100V	IR	10^{10}	-	-	10^{10}	-	-	Ω
Capacitance	1MHz	C	-	-	4.0	-	-	4.0	pF
Life Ratings									
Surge Life	100A (PW=20 μ s)	-	68100	-	-	68100	-	-	surges

MECHANICAL DIMENSIONS

DIMENSIONS
mm
(inches)

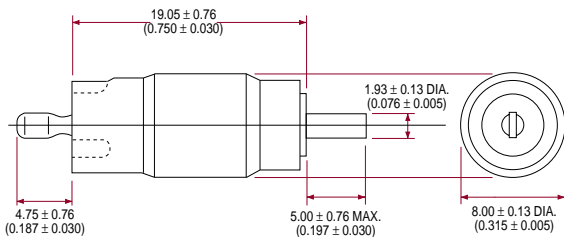

ORDERING INFORMATION

Devices in the PMT(301) series with other breakdown voltages in the 350 to 3500 V range are available upon request.

A complete part number is represented by the digits below. Breakdown voltages are expressed in Volts for devices <1000V and kV for devices \geq 1KV. For example, PMT(301)2.0 is a 2kV PMT(301) series device.

PMT(301) XXX for 350-800V
 PMT(301) X.X for 1.0-3.5 kV
 Series ——— Breakdown Voltage
 PMT3(310) ——— See specifications tables



DESCRIPTION

CP Clare's Sparkgap line of two electrode spark gaps excel in applications that require the efficient transfer of high voltage, high-energy pulses and DC overvoltage protection for magnetrons, diodes, capacitors, etc. The SB series (0.40-5kV) can reliably switch pulses having peak currents of several kiloamperes with energy contents as high as 50 joules. The larger SG series (2-40kV) can reliably switch pulses having peak currents of several kiloamperes and energy contents as high as 100 joules.

FEATURES

- Tight DC breakdown voltage tolerance ($\pm 10\%$)
- Long-life tungsten electrodes
- Rugged glass-to-metal seals

APPLICATIONS

- Test equipment
- Video displays
- Pulse generators

STANDARD VOLTAGES

Series	DC Breakdown Voltage (typ)	Units
SB	400	V
	600	V
	800	V
	1.0	kV
	1.5	kV
	2.0	kV
	3.0	kV
	4.0	kV
	5.0	kV
SG	2.0	kV
	5.0	kV
	10.0	kV
	15.0	kV
	20.0	kV
	25.0	kV
	30.0	kV
	35.0	kV
40.0	kV	

(See detailed specifications for more information.)

TWO ELECTRODE HIGH-ENERGY SPARK GAPS

Sparkgaps

SPECIFICATIONS

All characteristics at 25°C

PARAMETER	CONDITIONS	SYMBOL	SB-400			SB-600			SB-800			UNITS
			MIN	TYP	MAX	MIN	TYP	MAX	MIN	TYP	MAX	
Device Specifications												
DC Breakdown	100V/s	V_{BD}	360	400	440	540	600	660	720	800	880	V
Insulation Resistance	100V	IR	10^{10}	-	-	10^{10}	-	-	10^{10}	-	-	Ω
Dimension A			-	-	0.470	-	-	0.470	-	-	0.470	inches
Life Ratings												
Surge Life	3kA (PW=15 μ s) into 0.5 Ω		1100	-	-	1100	-	-	1100	-	-	surges
Max Pulse Energy			50	-	-	50	-	-	50	-	-	J

PARAMETER	CONDITIONS	SYMBOL	SB-1.0			SB-1.5			SB-2.0			UNITS
			MIN	TYP	MAX	MIN	TYP	MAX	MIN	TYP	MAX	
Device Specifications												
DC Breakdown	100V/s	V_{BD}	0.9	1.0	1.1	1.35	1.5	1.65	1.8	2.0	2.2	kV
Insulation Resistance	100V	IR	10^{10}	-	-	10^{10}	-	-	10^{10}	-	-	Ω
Dimension A			-	-	0.470	-	-	0.480	-	-	0.480	inches
Life Ratings												
Surge Life	3kA (PW=15 μ s) into 0.5 Ω		1100	-	-	1100	-	-	1100	-	-	surges
Max Pulse Energy			50	-	-	50	-	-	50	-	-	J

PARAMETER	CONDITIONS	SYMBOL	SB-3.0			SB-4.0			SB-5.0			UNITS
			MIN	TYP	MAX	MIN	TYP	MAX	MIN	TYP	MAX	
Device Specifications												
DC Breakdown	100V/s	V_{BD}	2.7	3.0	3.3	3.6	4.0	4.4	4.5	5.0	5.5	kV
Insulation Resistance	100V	IR	10^{10}	-	-	10^{10}	-	-	10^{10}	-	-	Ω
Dimension A			-	-	0.500	-	-	0.520	-	-	0.520	inches
Life Ratings												
Surge Life	3kA (PW=15 μ s) into 0.5 Ω		1100	-	-	1100	-	-	1100	-	-	surges
Max Pulse Energy			50	-	-	50	-	-	50	-	-	J

PARAMETER	CONDITIONS	SYMBOL	SG-2.0			SG-5.0			SG-10.0			UNITS
			MIN	TYP	MAX	MIN	TYP	MAX	MIN	TYP	MAX	
Device Specifications												
DC Breakdown	100V/s	V_{BD}	1.8	2.0	2.2	4.5	5.0	5.5	9.9	10.0	11.0	kV
Insulation Resistance	100V	IR	10^{10}	-	-	10^{10}	-	-	10^{10}	-	-	Ω
Dimension A			-	-	2.20	-	-	2.20	-	-	2.20	inches
Dimension B			-	-	0.60	-	-	0.60	-	-	0.60	inches
Life Ratings												
Surge Life	3kA (PW=15 μ s) into 0.5 Ω		1500	-	-	1500	-	-	1500	-	-	surges
Max Pulse Energy			100	-	-	100	-	-	100	-	-	J

SPECIFICATIONS

All characteristics at 25°C

PARAMETER	CONDITIONS	SYMBOL	SG-15.0			SG-20.0			SG-25.0			UNITS
			MIN	TYP	MAX	MIN	TYP	MAX	MIN	TYP	MAX	
Device Specifications												
DC Breakdown	100V/s	V_{BD}	13.5	15.0	16.5	18.0	20.0	22	22.5	25.0	27.5	kV
Insulation Resistance	100V	IR	10^{10}	-	-	10^{10}	-	-	10^{10}	-	-	Ω
Dimension A	-	-	-	-	2.20	-	-	3.04	-	-	3.04	inches
Dimension B	-	-	-	-	0.60	-	-	1.21	-	-	1.21	inches
Life Ratings												
Surge Life	3kA (PW=15 μ s)	-	1500	-	-	1500	-	-	1500	-	-	surges
Max Pulse Energy	into 0.5 Ω	-	100	-	-	100	-	-	100	-	-	J

PARAMETER	CONDITIONS	SYMBOL	SG-30.0			SG-35.0			SG-40.0			UNITS
			MIN	TYP	MAX	MIN	TYP	MAX	MIN	TYP	MAX	
Device Specifications												
DC Breakdown	100V/s	V_{BD}	27.0	30.0	33.0	31.5	35.0	38.5	36.0	40.0	44.0	kV
Insulation Resistance	100V	IR	10^{10}	-	-	10^{10}	-	-	10^{10}	-	-	Ω
Dimension A	-	-	-	-	3.32	-	-	3.32	-	-	3.57	inches
Dimension B	-	-	-	-	1.21	-	-	1.21	-	-	1.21	inches
Life Ratings												
Surge Life	3kA (PW=15 μ s)	-	1500	-	-	1500	-	-	1500	-	-	surges
Max Pulse Energy	into 0.5 Ω	-	100	-	-	100	-	-	100	-	-	J

MECHANICAL DIMENSIONS

DIMENSIONS
mm
(inches)

SB SERIES

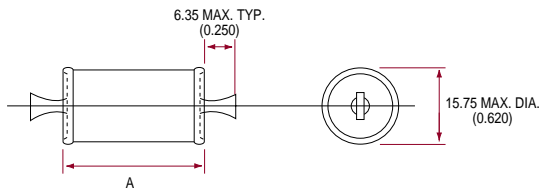

SG SERIES

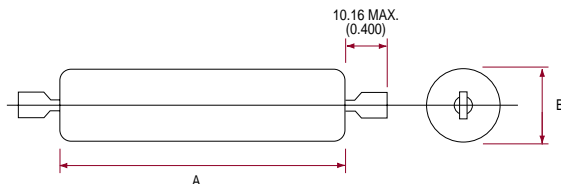

ORDERING INFORMATION

Sparkgaps with DC voltages other than the standard values listed (in the ranges of .40-5kV for the SB series and 2.0-40kV for the SG series) are available upon request. All Sparkgaps are available with .360 O.D. x .406 endcaps or .250 O.D. x .270 endcaps.

A complete part number is represented by the digits below. Breakdown voltages are expressed in Volts for devices <1000V and kV for devices \geq 1kV. For example, SB-400 is a 400V SB series device, and SG-10.0 is a 10kV SG series device.

SB- XXX for 400-800V
 SB- X.X for 1.0V-5.0 kV
 SG- XX.X for all voltages

Series — SB
 SG

Breakdown voltage
 See specification tables

Triggergaps



DESCRIPTION

CP Clare's Triggergaps are high-energy spark gaps that are capable of switching stored energy in a fraction of a microsecond. Triggergaps require no standby power, are extremely rugged, and require only a low-energy, high-voltage triggering pulse. The miniature TA series (1-15kV) provides switching capability for pulses with energy content as high as 50 joules. The larger TB series (2.5-25 kV) will reliably switch pulses with up to 300 joules of energy. The TG-221 to 226 (1-60 kV) can switch pulses with energy contents of up to 6000 joules and feature adjustable self-breakdown voltages.

FEATURES

- Tight self-breakdown voltage tolerance ($\pm 10\%$; TA & TB series)
- Adjustable self-breakdown voltage (TG-221 to TG-226)
- Rugged ceramic-metal construction
- Refractory metal electrodes
- Corrosion-resistant stainless steel external surfaces (TB series)

APPLICATIONS

- High current surge generators
- Exploding bridge wire systems
- Crowbars
- Flashtube triggers

STANDARD VOLTAGES

Series or P/N	Self-Breakdown Voltage (typ)	Units
TA	1.0	kV
	2.0	kV
	5.0	kV
	7.0	kV
	10.0	kV
	15.0	kV
TB	2.5	kV
	5.0	kV
	10.0	kV
	15.0	kV
	20.0	kV
	25.0	kV
TG-221	1.0-20.0	kV
TG-222	18.0-40.0	kV
TG-224	1.0-20.0	kV
TG-225	18.0-40.0	kV
TG-226	35.0-60.0	kV

SPECIFICATIONS

All characteristics at 25°C

PARAMETER	CONDITIONS	SYMBOL	TA-1.0			TA-2.0			TA-5.0			UNITS
			MIN	TYP	MAX	MIN	TYP	MAX	MIN	TYP	MAX	
Device Specifications												
Self-Breakdown Voltage	100V/s	E_z	0.9	1.0	1.1	1.8	2.0	2.2	4.5	5.0	5.5	kV
Applied Voltage		E_{bb}	0.4	-	0.85	0.7	-	1.7	1.2	-	4.2	kV
Trigger Voltage ¹	$t_r=0.5\mu s$, PW=3.0 μs	e_{trig}	3.0	-	2.5	3.0	-	2.5	3.5	-	2.5	kV pk
Dimension A		-	0.687	0.750	0.813	0.697	0.760	0.823	0.697	0.760	0.823	inches
Life Ratings												
Discharge Life ²	≥ 1000 shots into .2 Ω	-	45	-	-	50	-	-	50	-	-	J

PARAMETER	CONDITIONS	SYMBOL	TA-7.0			TA-10.0			TA-15.0			UNITS
			MIN	TYP	MAX	MIN	TYP	MAX	MIN	TYP	MAX	
Device Specifications												
Self-Breakdown Voltage	100V/s	E_z	6.3	7.0	7.7	9.0	10.0	11.0	13.5	15.0	16.5	kV
Applied Voltage		E_{bb}	1.9	-	5.8	3.5	-	8.5	7.0	-	12.5	kV
Trigger Voltage ¹	$t_r=0.5\mu s$, PW=3.0 μs	e_{trig}	3.7	-	2.8	5	-	3.5	8.0	-	4.5	kV pk
Dimension A		-	0.697	0.760	0.823	0.727	0.790	0.853	0.767	0.830	0.893	inches
Life Ratings												
Discharge Life ²	≥ 1000 shots into .2 Ω	-	50	-	-	60	-	-	70	-	-	J

PARAMETER	CONDITIONS	SYMBOL	TB-2.5			TB-5.0			TB-10.0			UNITS
			MIN	TYP	MAX	MIN	TYP	MAX	MIN	TYP	MAX	
Device Specifications												
Self-Breakdown Voltage	100V/s	E_z	2.25	2.50	2.75	4.5	5.0	5.5	9.0	10.0	11.0	kV
Applied Voltage		E_{bb}	0.8	-	2.0	1.5	-	4.0	3.0	-	8.0	kV
Trigger Voltage ¹	$t_r=0.5\mu s$, PW=3.0 μs	e_{trig}	3.1	-	1.8	3.2	-	1.9	4.6	-	2.1	kV pk
Dimension A		-	-	1.99	-	-	1.99	-	-	1.99	-	inches
Dimension B		-	-	-	0.23	-	-	0.23	-	-	0.58	inches
Dimension C		-	-	-	2.03	-	-	2.03	-	-	2.10	inches
Life Ratings												
Discharge Life ²	discharges into .3 Ω	-	150	-	-	150	-	-	300	-	-	J

PARAMETER	CONDITIONS	SYMBOL	TB-15.0			TB-20.0			TB-25.0			UNITS
			MIN	TYP	MAX	MIN	TYP	MAX	MIN	TYP	MAX	
Device Specifications												
Self-Breakdown Voltage	100V/s	E_z	13.5	15.0	16.5	18.0	20.0	22.0	22.5	25.0	27.5	kV
Applied Voltage		E_{bb}	4.5	-	12.0	6.0	-	16.0	7.5	-	20.0	kV
Trigger Voltage ¹	$t_r=0.5\mu s$, PW=3.0 μs	e_{trig}	6.3	-	3.5	8.0	-	4.5	9.7	-	5.2	kV pk
Dimension A		-	-	2.67	-	-	2.79	-	-	2.79	-	inches
Dimension B		-	-	-	0.58	-	-	0.58	-	-	0.58	inches
Dimension C		-	-	-	2.10	-	-	2.10	-	-	2.10	inches
Life Ratings												
Discharge Life ²	discharges into .3 Ω	-	300	-	-	300	-	-	300	-	-	J

¹ The trigger voltages given in these tables are the minimum triggering voltages necessary for triggering at the corresponding applied voltage limits. As the applied trigger voltage increases, the trigger voltage required for triggering decreases. It is assumed that the trigger is applied across the trigger and adjacent main electrodes — higher trigger voltages are required if it is applied across the trigger voltage and opposite main electrodes.

² End point for life testing is a 15% reduction in the self-breakdown voltage.

³ Because the self-breakdown voltage of these devices is adjustable, the trigger voltage required for any particular applied voltage cannot be specified. Clare suggests setting the self-breakdown voltage to at least 115% of the maximum applied voltage.

HIGH-ENERGY TRIGGERED SPARK GAPS

Triggergaps

SPECIFICATIONS

All characteristics at 25°C

PARAMETER	CONDITIONS	SYMBOL	TG-221			TG-222			TG-224			UNITS
			MIN	TYP	MAX	MIN	TYP	MAX	MIN	TYP	MAX	
Device Specifications												
Self-Breakdown Voltage	100V/s	E_z	1.0	-	20.0	18.0	-	40.0	1.0	-	20.0	kV
Applied Voltage		E_{bb}	0.5	-	18.0	15.0	-	35.0	0.5	-	19.0	kV
Dimension A		-	-	2.25	-	-	3.25	-	-	3.00	-	inches
Dimension B		-	-	2.50	-	-	2.50	-	-	4.50	-	inches
Life Ratings												
Peak Current	PW=30µs	-	20	-	-	20	-	-	50	-	-	kA
Discharge Life ³	1000 shots into 1Ω	-	3000	-	-	3000	-	-	6000	-	-	J

PARAMETER	CONDITIONS	SYMBOL	TG-225			TG-226			UNITS
			MIN	TYP	MAX	MIN	TYP	MAX	
Device Specifications									
Self-Breakdown Voltage	100V/s	E_z	18.0	-	40.0	35.0	-	60.0	kV
Applied Voltage		E_{bb}	15.0	-	35.0	30.0	-	55.0	kV
Dimension A		-	-	3.50	-	-	4.50	-	inches
Dimension B		-	-	4.50	-	-	4.50	-	inches
Life Ratings									
Peak Current	PW=30µs	-	50	-	-	50	-	-	kA
Discharge Life ³	1000 shots into 1Ω	-	6000	-	-	6000	-	-	J

¹ The trigger voltages given in these tables are the minimum triggering voltages necessary for triggering at the corresponding applied voltage limits. As the applied trigger voltage increases, the trigger voltage required for triggering decreases. It is assumed that the trigger is applied across the trigger and adjacent main electrodes — higher trigger voltages are required if it is applied across the trigger voltage and opposite main electrodes.

² End point for life testing is a 15% reduction in the self-breakdown voltage.

³ Because the self-breakdown voltage of these devices is adjustable, the trigger voltage required for any particular applied voltage cannot be specified. Clare suggests setting the self-breakdown voltage to at least 115% of the maximum applied voltage.

MECHANICAL DIMENSIONS

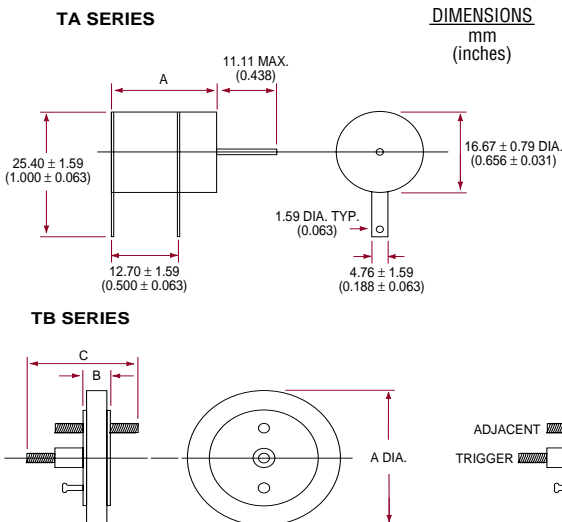

ORDERING INFORMATION

Triggergaps with self-breakdown voltages other than the standard values listed (in the ranges of 1-15kV for the TA series and 2.5-25kV for the TB series) are available upon request.

A complete part number is represented by the digits below. Self-breakdown voltages are expressed in kV. For example, TA-5.0 is a 5kV TA series device and TB-25.0 is a 25kV TB series device. The TG-221 to 226 are ordered by the appropriate part number as given in the specifications.

TA- X.X for 1.0-9.0kV
 TA- XX.X for 10.0-15.0kV
 TB- X.X for 2.5-9.0kV
 TB- XX.X for 10.0-25.0kV

Series
 TA
 TB

Self-breakdown voltage
 See specification tables

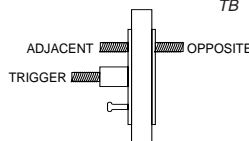



DESCRIPTION

CP Clare's UNI-IMP high-speed transient surge protectors (0.55-20kV) provide the ultimate protection from high-energy, fast-rising transients such as Nuclear EMP. These devices are constructed using a proprietary semiconductor junction process that results in nanosecond response times combined with peak current ratings in excess of 20kA. A unique benefit of this technology is that the breakdown voltage is virtually independent of the rise time of the transient. In addition, the low capacitance of these devices allows for direct placement on high-frequency lines and antenna feeds without excessive loading.

FEATURES

- Fast impulse breakdown ($\leq 120\%$ of typical DC breakdown to $200\text{kV}/\mu\text{s}$)
- Tight DC breakdown voltage tolerance ($\pm 10\%$)
- Non-radioactive
- Low capacitance

APPLICATIONS

- Antenna feedlines
- Test equipment
- Video displays
- Medical electronics
- Instrumentation circuits

STANDARD VOLTAGES

Series	DC Breakdown Voltage (typ)	Unit
UBD	550	V
	600	V
	650	V
	750	V
	850	V
	1.0	kV
	1.2	kV
	1.5	kV
	2.0	kV
	2.5	kV
	3.0	kV
UBT and UGT	4.0	kV
	5.0	kV
	6.0	kV
	7.5	kV
	10.0	kV
	12.0	kV
	15.0	kV
	20.0	kV

(See detailed specifications for more information.)

HIGH-SPEED TRANSIENT SURGE PROTECTORS

UNI-IMPS

SPECIFICATIONS

All characteristics at 25°C

PARAMETER	CONDITIONS	SYMBOL	UBD-550			UBD-600			UBD-650			UNITS
			MIN	TYP	MAX	MIN	TYP	MAX	MIN	TYP	MAX	
Device Specifications												
DC Breakdown	100V/s	V_{BD}	495	550	605	540	600	660	585	650	715	V
Impulse Breakdown	5kV/ μ s	V_{bd}	-	-	660	-	-	720	-	-	780	V
Insulation Resistance	100V	IR	10^{10}	-	-	10^{10}	-	-	10^{10}	-	-	Ω
Capacitance	1MHz	C	-	-	20.0	-	-	20.0	-	-	20.0	pF
Life Ratings												
Surge Life	3kA (PW=15 μ s)	-	330	-	-	420	-	-	500	-	-	surges

PARAMETER	CONDITIONS	SYMBOL	UBD-750			UBD-850			UBD-1.0			UNITS
			MIN	TYP	MAX	MIN	TYP	MAX	MIN	TYP	MAX	
Device Specifications												
DC Breakdown	100V/s	V_{BD}	675	750	825	765	850	935	900	1000	1100	V
Impulse Breakdown	5kV/ μ s	V_{bd}	-	-	900	-	-	1020	-	-	1200	V
Insulation Resistance	100V	IR	10^{10}	-	-	10^{10}	-	-	10^{10}	-	-	Ω
Capacitance	1MHz	C	-	-	20.0	-	-	20.0	-	-	15.0	pF
Life Ratings												
Surge Life	3kA (PW=15 μ s)	-	660	-	-	830	-	-	1080	-	-	surges

PARAMETER	CONDITIONS	SYMBOL	UBD-1.2			UBD-1.5			UBD-2.0			UNITS
			MIN	TYP	MAX	MIN	TYP	MAX	MIN	TYP	MAX	
Device Specifications												
DC Breakdown	100V/s	V_{BD}	1.08	1.20	1.32	1.35	1.50	1.65	1.80	2.00	2.20	kV
Impulse Breakdown	5kV/ μ s	V_{bd}	-	-	1.44	-	-	1.80	-	-	2.40	kV
Insulation Resistance	100V	IR	10^{10}	-	-	10^{10}	-	-	10^{10}	-	-	Ω
Capacitance	1MHz	C	-	-	15.0	-	-	15.0	-	-	10.0	pF
Life Ratings												
Surge Life	3kA (PW=15 μ s)	-	1410	-	-	1900	-	-	2400	-	-	surges

PARAMETER	CONDITIONS	SYMBOL	UBD-2.5			UBD-3.0			UBD-4.0			UNITS
			MIN	TYP	MAX	MIN	TYP	MAX	MIN	TYP	MAX	
Device Specifications												
DC Breakdown	100V/s	V_{BD}	2.25	2.50	2.75	2.70	3.00	3.30	3.60	4.00	4.40	kV
Impulse Breakdown	5kV/ μ s	V_{bd}	-	-	3.00	-	-	3.60	-	-	4.80	kV
Insulation Resistance	100V	IR	10^{10}	-	-	10^{10}	-	-	10^{10}	-	-	Ω
Capacitance	1MHz	C	-	-	10.0	-	-	5.0	-	-	5.0	pF
Life Ratings												
Surge Life	3kA (PW=15 μ s)	-	2400	-	-	2400	-	-	2400	-	-	surges

PARAMETER	CONDITIONS	SYMBOL	UBT-4.0 UGT-4.0			UBT-5.0 UGT5.0			UBT-6.0 UGT-6.0			UNITS
			MIN	TYP	MAX	MIN	TYP	MAX	MIN	TYP	MAX	
Device Specifications												
DC Breakdown	100V/s	V_{BD}	3.60	4.00	4.40	4.50	5.00	5.50	5.40	6.00	6.60	kV
Impulse Breakdown	5kV/ μ s	V_{bd}	-	-	4.80	-	-	6.00	-	-	7.20	kV
Insulation Resistance	100V	IR	10^{10}	-	-	10^{10}	-	-	10^{10}	-	-	Ω
Capacitance	1MHz	C	-	-	5.0	-	-	3.0	-	-	3.0	pF
Life Ratings												
Surge Life	10kA (PW=5 μ s)	-	1300	-	-	1300	-	-	1300	-	-	surges

SPECIFICATIONS

All characteristics at 25°C

PARAMETER	CONDITIONS	SYMBOL	UBT-7.5 UGT-7.5			UBT-10.0 UGT-10.0			UBT-12.0 UGT-12.0			UNITS
			MIN	TYP	MAX	MIN	TYP	MAX	MIN	TYP	MAX	
Device Specifications												
DC Breakdown	100V/s	V_{BD}	6.75	7.50	8.25	9.0	10.0	11.0	10.8	12.0	13.2	kV
Impulse Breakdown	5KV/ μ s	V_{bd}	-	-	4.8	-	-	6	-	-	7.2	kV
Insulation Resistance	100V	IR	10^{10}	-	-	10^{10}	-	-	10^{10}	-	-	Ω
Capacitance	1MHz	C	-	-	5.0	-	-	3.0	-	-	3.0	pF
Life Ratings												
Surge Life	10kA (PW=5 μ s)	-	1300	-	-	1300	-	-	1300	-	-	surges

PARAMETER	CONDITIONS	SYMBOL	UBT-15.0 UGT-15.0			UBT-20.0 UGT-20.0			UNITS
			MIN	TYP	MAX	MIN	TYP	MAX	
Device Specifications									
DC Breakdown	100V/s	V_{BD}	13.5	15.0	16.5	18.0	20.0	22.0	kV
Impulse Breakdown	5KV/ μ s	V_{bd}	-	-	18.0	-	-	24.0	kV
Insulation Resistance	100V	IR	10^{10}	-	-	10^{10}	-	-	Ω
Capacitance	1MHz	C	-	-	2.0	-	-	2.0	pF
Life Ratings									
Surge Life	10kA (PW=5 μ s)	-	1300	-	-	1300	-	-	surges

MECHANICAL DIMENSIONS

DIMENSIONS
mm
(inches)

UBT SERIES

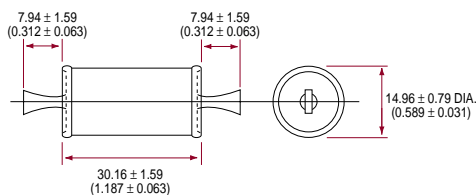

UGT SERIES

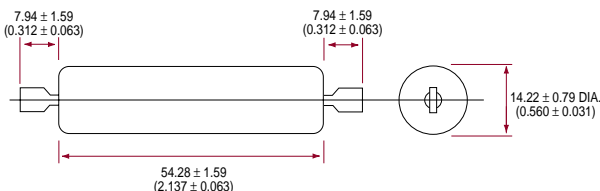

UBD SERIES

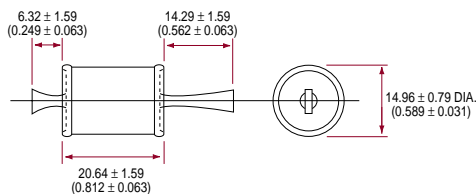

ORDERING INFORMATION

UNI-IMPS with other breakdown voltages in the 0.55 to 20kV range are available on request. All UNI-IMPs are available with .360 O.D. endcaps. UGTs are also available with .250 O.D. endcaps. UBDs are available with a threaded male termination (#8-20) on one end.

A complete part number is represented by the digits below. Breakdown voltages are expressed in Volts for devices <1000V and kV for devices \geq 1kV. For example, UBD-550 is a 550V UBD series device, and UBT-10.0 is a 10kV UBT series device.

UBT- X.X for 4.0-9.0kV
 UBT-XX.X for 10.0-20.0kV
 UGT- X.X for 4.0-9.0kV
 UGT-XX.X for 10.0-20.0kV

Series
 UBD
 UBT
 UGT

Breakdown Voltage
 See specifications
 tables

HIGH ENERGY SPARK GAP DEVICES

TG Legacy Series



DESCRIPTION

CP Clare's TG Legacy Series of two electrode sparkgaps excel in applications that require the efficient transfer of high voltage, high energy pulses and DC overvoltage protection for magnetrons, diodes, capacitors, etc. The TG Legacy Series also includes three electrode triggered sparkgaps (cold cathode thyratrons) for switching high levels of stored energy in fractions of a microsecond, on command, using low energy control pulses.

FEATURES

- Tight DC breakdown voltage tolerance ($\pm 10\%$)
- Long-life tungsten or molybdenum electrodes
- Rugged ceramic-to-metal or glass-to-metal construction

APPLICATIONS

- Test equipment
- Video displays
- Pulse generators
- Medical electronics

VOLTAGE RANGES

Series	DC Breakdown Voltage	Units
TG Two Electrode	0.345 - 60.0	kV
TG Three Electrode	1.0 - 27.5	kV

(See detailed specifications for more data. Contact CP Clare for TG and XG part numbers or for other requirements not listed.)

Two Electrode High-Energy Spark Gaps

SPECIFICATIONS

All characteristics at 25°C.

PART NUMBER	DC BREAKDOWN VOLTAGE (KV ± 10%)	INITIAL PULSE BREAKDOWN VOLTAGE (KV) ⁽³⁾	REPETITIVE PULSE BREAKDOWN VOLTAGE (KV) ⁽³⁾	PACKAGE OUTLINE	DIMENSION A (INCHES)	DIMENSION B (INCHES)	DIMENSION C (INCHES)
TG-6	2.50	—	—	1	0.620 max	0.455 ± 0.031	0.188 max
TG-8 ⁽¹⁾	2.50	—	—	1	0.620 max	1.000 ± 0.031	0.125 max
TG-9	3.00	—	—	1	0.620 max	0.460 ± 0.031	0.188 max
TG-14	12.50	19.0 - 28.0	17.0 - 21.0	2	—	—	—
TG-15	3.00	—	—	1	0.620 max	1.000 ± 0.031	0.125 max
TG-16 ⁽¹⁾	3.00	—	—	1	0.620 max	1.000 ± 0.031	0.125 max
TG-17	2.60	—	—	1	0.620 max	0.455 ± 0.031	0.188 max
TG-19 ⁽²⁾	2.20 ± 0.20	—	—	1	0.620 max	0.455 ± 0.031	0.275 ± .07
TG-20A	21.00	17.0 - 24.0	—	7	2.250 ± 0.125	—	—
TG-22	1.00	—	—	1	0.620 max	0.435 ± .031	0.188 max
TG-24	15.50	35.5 max	—	2	—	—	—
TG-25	0.40	—	—	1	0.600 ± .030	1.100 ± .031	0.250 max
TG-26A	0.75	—	—	2	—	—	—
TG-27A	1.00	—	—	2	—	—	—
TG-28A	1.25	—	—	2	—	—	—
TG-29	1.50	—	—	2	—	—	—
TG-30	2.00	—	—	2	—	—	—
TG-31	2.50	—	—	2	—	—	—
TG-32	3.00	—	—	2	—	—	—
TG-33	4.00	—	—	2	—	—	—
TG-34	5.00	—	—	2	—	—	—
TG-35	6.00	—	—	2	—	—	—
TG-36	8.00	—	—	2	—	—	—
TG-37	10.00	—	—	2	—	—	—
TG-38	12.50	—	—	2	—	—	—
TG-39	15.00	—	—	2	—	—	—
TG-40	17.50	—	—	2	—	—	—
TG-41A	0.75	—	—	3	—	—	—
TG-42A	1.00	—	—	3	—	—	—
TG-43A	1.25	—	—	3	—	—	—
TG-44	1.50	—	—	3	—	—	—
TG-45	2.00	—	—	3	—	—	—
TG-46	2.50	—	—	3	—	—	—
TG-47	3.00	—	—	3	—	—	—
TG-48	4.00	—	—	3	—	—	—
TG-49	5.00	—	—	3	—	—	—
TG-50	6.00	—	—	3	—	—	—
TG-51	8.00	—	—	3	—	—	—
TG-52	10.00	—	—	3	—	—	—
TG-53	12.50	—	—	3	—	—	—
TG-54	15.00	—	—	3	—	—	—
TG-55	17.50	—	—	3	—	—	—
TG-56	20.00	—	—	4	3.750 ± .125	—	—
TG-57	25.00	—	—	4	3.750 ± .125	—	—
TG-58	30.00	—	—	4	4.000 ± .188	—	—
TG-59	40.00	—	—	4	4.250 ± .188	—	—
TG-60	50.00	—	—	4	4.500 ± .188	—	—

⁽¹⁾ 6-32 tapped hole in non-tubulated end.

⁽²⁾ Identical tubulation on both ends.

⁽³⁾ The voltage level at which the spark discharge occurs when a unipolarity pulse train is applied to the gap. Typically, the pulse repetition rate is 400 pps (pulses/second) with a rise time of 0.3 μs and a pulse width of 0.5 μs. The "initial" range specifies at what increasing voltage the gap begins to fire and the "rep" range specifies at what decreasing voltage the gap ceases to fire repetitively.

HIGH ENERGY SPARK GAP DEVICES

Two Electrode High-Energy Spark Gaps

SPECIFICATIONS

All characteristics at 25°C.

PART NUMBER	DC BREAKDOWN VOLTAGE (KV ± 10%)	INITIAL PULSE BREAKDOWN VOLTAGE (KV) ⁽³⁾	REPETITIVE PULSE BREAKDOWN VOLTAGE (KV) ⁽³⁾	PACKAGE OUTLINE	DIMENSION A (INCHES)	DIMENSION B (INCHES)	DIMENSION C (INCHES)
TG-61	0.75	—	—	5	0.770 ± .062	0.310 ± .020	0.520 ± .022
TG-62	1.00	—	—	5	0.770 ± .062	0.310 ± .020	0.520 ± .022
TG-63	1.25	—	—	5	0.770 ± .062	0.310 ± .020	0.520 ± .022
TG-64	1.50	—	—	5	0.770 ± .062	0.310 ± .020	0.520 ± .022
TG-65	2.00	—	—	5	0.770 ± .062	0.310 ± .020	0.520 ± .022
TG-66	2.50	—	—	5	0.790 ± .062	0.310 ± .020	0.540 ± .022
TG-67	3.00	—	—	5	0.790 ± .062	0.310 ± .020	0.540 ± .022
TG-68	4.00	—	—	5	0.820 ± .062	0.340 ± .020	0.570 ± .022
TG-69	5.00	—	—	5	0.820 ± .062	0.340 ± .020	0.570 ± .022
TG-70	6.00	—	—	5	0.820 ± .062	0.340 ± .020	0.570 ± .022
TG-71	8.00	—	—	5	0.860 ± .062	0.380 ± .020	0.610 ± .022
TG-72	10.00	—	—	5	0.860 ± .062	0.380 ± .020	0.610 ± .022
TG-73	12.50	—	—	5	0.965 ± .062	0.490 ± .020	0.715 ± .022
TG-74	15.00	—	—	5	0.965 ± .062	0.490 ± .020	0.715 ± .022
TG-75	17.50	—	—	5	0.965 ± .062	0.490 ± .020	0.715 ± .022
TG-76	0.40 ± .05	—	—	1	0.600 ± .030	0.494 ± .031	0.250 max
TG-77	-	9.0 - 11.5	9.0 - 11.5	special	—	—	—
TG-78	1.00	—	—	1A	0.620 max	0.425 ± .031	—
TG-79	2.50	—	—	2	—	—	—
TG-82	15.00	15.0 - 19.0	13.0 - 18.0	7A	0.950 ± .050	—	—
TG-83	16.50	16.0 - 22.0 ⁽⁴⁾	16.0 - 22.0 ⁽⁴⁾	2	—	—	—
TG-84	30.00	31.0 - 43.0 ⁽⁴⁾	31.0 - 43.0 ⁽⁴⁾	4	4.000 ± .188	—	—
TG-85	15.00	9.0 - 11.5	9.0 - 11.5	special	—	—	—
TG-86	0.60	—	—	1A	0.620 max	0.537 ± .031	—
TG-87	0.80	—	—	1A	0.620 max	0.537 ± .031	—
TG-89 ⁽²⁾	2.90	—	—	1	0.620 max	0.460 ± .031	0.188 max
TG-90	20.00	17.0 - 24.0	—	special	—	—	—
TG-98	0.345 ± .045	—	—	3A	—	—	—
TG-99	2.75 ± 0.25	—	—	2	—	—	—
TG-100	38.00	—	—	4	4.000 ± .188	0.440 ± .031	0.188 max
TG-102	1.25	—	—	1A	0.620 max	0.440 ± .031	0.188 max
TG-103	1.50	—	—	1A	0.620 max	0.445 ± .031	0.188 max
TG-104	2.00	—	—	1A	0.620 max	0.445 ± .031	0.188 max
TG-105	2.50	—	—	1A	0.620 max	0.445 ± .031	0.188 max
TG-106	3.00	—	—	1A	0.620 max	0.487 ± .031	0.188 max
TG-107	3.50	—	—	1A	0.620 max	0.487 ± .031	0.188 max
TG-108	4.00	—	—	1A	0.620 max	0.487 ± .031	0.188 max
TG-109	5.00	—	—	1A	0.620 max	0.487 ± .031	0.188 max
TG-110	0.40 ± .05	—	—	1A	0.620 max	—	—
TG-112	0.20 ± .10	—	—	1	0.620 max	0.455 ± .031	0.275 ± .075
TG-115	13.00 ± 1.00	—	—	3	—	—	—
TG-116 ⁽⁶⁾	25.00	—	—	4A	3.750 ± .125	—	—
TG-117	21.00	17.0 - 24.0	—	7	2.000 ± .125	—	—
TG-118	21.50	16.0 - 22.0	—	5	0.965 ± .062	0.490 ± .020	0.715 ± .022
TG-119	45.00	—	—	4	4.250 ± .188	—	—
TG-120	8.00	7.4 - 8.7	—	5	0.860 ± .062	0.380 ± .020	0.610 ± .022

⁽¹⁾ 6-32 tapped hole in non-tubulated end.

⁽²⁾ Identical tubulation on both ends.

⁽³⁾ The voltage level at which the spark discharge occurs when a unipolarity pulse train is applied to the gap. Typically, the pulse repetition rate is 400 pps (pulses/second) with a rise time of 0.3 μs and a pulse width of 0.5 μs. The "initial" range specifies at what increasing voltage the gap begins to fire and the "rep" range specifies at what decreasing voltage the gap ceases to fire repetitively.

⁽⁴⁾ Pulse repetition rate is 1500pps instead of the standard 400pps.

⁽⁵⁾ Though outlines 2, 3, and 3A are identical, the electrode materials and configurations vary internally.

⁽⁶⁾ Though outlines 4 and 4A are identical, gaps with outline 4A have heavier internal construction to withstand more severe shock and vibration.

Two Electrode High-Energy Spark Gaps

SPECIFICATIONS

All characteristics at 25°C.

PART NUMBER	DC BREAKDOWN VOLTAGE (KV ± 10%)	INITIAL PULSE BREAKDOWN VOLTAGE (KV) ⁽³⁾	REPETITIVE PULSE BREAKDOWN VOLTAGE (KV) ⁽³⁾	PACKAGE OUTLINE	DIMENSION A (INCHES)	DIMENSION B (INCHES)	DIMENSION C (INCHES)
TG-131	30.00	33.0	25.0	4A	4.000 ± .188	—	—
TG-132	2.00	—	—	special	—	—	—
TG-133	9.00	9.0 - 11.5	9.0 - 11.5	7A	0.192 ± .010	—	—
TG-135	2.00	—	—	special	—	—	—
TG-139	0.50	—	—	1A	0.487 ± .031	—	—
TG-140	0.60	—	—	3A	—	—	—
TG-148	6.00	7.5	6.0	special	—	—	—
TG-149	2.00	—	—	9	0.620 max	0.219 max	—
TG-152	0.50	—	—	special	—	—	—
TG-153	0.38 ± .02	—	—	1A	0.487 ± .031	—	—
TG-155	1.40	—	—	2	—	—	—
TG-156	2.625 ± 0.125	—	—	1	0.620 max	1.000 ± .031	0.188 max
TG-157	1.20	—	—	9	0.515 max	0.125 max	—
TG-162	21.00 ± 1.00	—	—	4	3.750 ± .125	—	—
TG-163	31.50 ± 3.00	—	—	4	4.000 ± .188	—	—
TG-164	2.20	—	—	9	0.620 max	0.219nom	—
TG-166	0.40	—	—	9	0.515 max	0.125 max	—
TG-167	0.60	—	—	9	0.515 max	0.125 max	—
TG-168	0.80	—	—	9	0.515 max	0.125 max	—
TG-169	1.00	—	—	9	0.515 max	0.125 max	—
TG-170	2.50	—	—	9	0.620 max	0.219 max	—
TG-171	3.00	—	—	9	0.620 max	0.219 max	—
TG-172	3.50	—	—	9	0.620 max	0.219 max	—
TG-173	4.00	—	—	9	0.620 max	0.219 max	—
TG-174	5.00	—	—	9	0.620 max	0.219 max	—
TG-175	6.00	6.0 - 7.5	6.0 - 7.5	9	0.620 max	0.219 max	—
TG-176	6.00	—	—	7	2.250 ± 0.125	—	—
TG-183	35.00	—	—	4	4.000 ± .188	—	—
TG-184 ⁽⁵⁾	7.00	—	—	3A	—	—	—
TG-186	20.00	—	—	4	3.750 ± .125	—	—
TG-187	1.50	—	—	3	—	—	—
TG-188	0.60	—	—	1	0.620 max	1.000 ± .031 max	0.188 max
TG-189	0.50	—	—	9	0.515 max	0.125 nom	—
TG-191 ⁽²⁾	0.45	—	—	1	0.620 max	0.455 ± 0.031	0.275 ± 0.075
TG-192	31.00 ± 3.0	—	—	4	4.000 ± .188	—	—
TG-193	2.30	—	—	special	—	—	—
TG-194	60.00 ± 8.0	—	—	4	4.500 ± .188	—	—
TG-196	9.00	9.0 - 11.5	9.0 - 11.5	7A	0.500 ± 0.30	—	—
TG-197	18.375 ± 0.875	—	—	2	—	—	—
TG-198 ⁽¹⁾	1.60	—	—	1	0.620 max	1.000 ± 0.031	0.125 max
TG-249	0.18 ± .05	—	—	1A	0.450 ± .031	—	—
TG-359	0.345 ± 0.45	—	—	special	—	—	—
TG-366A	14.00	—	—	special	—	—	—
TG-373	21.00	—	—	special	—	—	—
TG-375	20.5 - 24.0	—	—	4	4.000 ± .188	—	—
TG-376	14.8 - 18.15	—	—	4	4.000 ± .188	—	—

⁽¹⁾ 6-32 tapped hole in non-tubulated end.

⁽²⁾ Identical tubulation on both ends.

⁽³⁾ The voltage level at which the spark discharge occurs when a unipolarity pulse train is applied to the gap. Typically, the pulse repetition rate is 400 pps (pulses/second) with a rise time of 0.3 μs and a pulse width of 0.5 μs. The "initial" range specifies at what increasing voltage the gap begins to fire and the "rep" range specifies at what decreasing voltage the gap ceases to fire repetitively.

⁽⁴⁾ Pulse repetition rate is 1500pps instead of the standard 400pps.

⁽⁵⁾ Though outlines 2, 3, and 3A are identical, the electrode materials and configurations vary internally.

⁽⁶⁾ Though outlines 4 and 4A are identical, gaps with outline 4A have heavier internal construction to withstand more severe shock and vibration.

HIGH ENERGY SPARK GAP DEVICES

Two Electrode High-Energy Spark Gaps

DIMENSIONS
mm
(inches)

MECHANICAL DIMENSIONS

TG LEGACY - 1

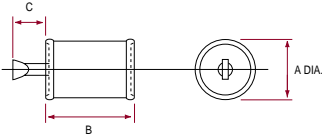

TG LEGACY 1-A

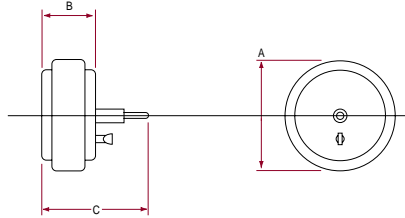

TG LEGACY - 2/3/A

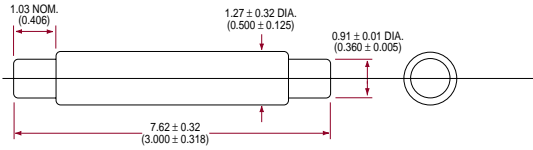

TG LEGACY - 4/A

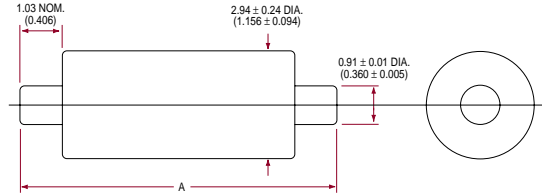

TG LEGACY - 5

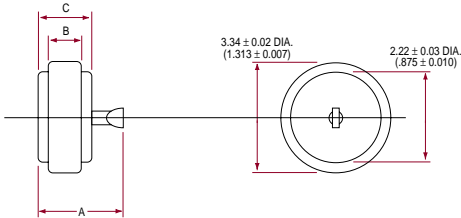

TG LEGACY - 7

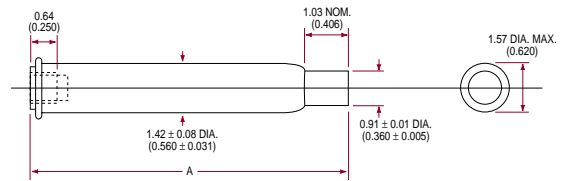

TG LEGACY - 7A

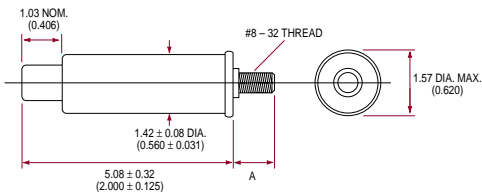

TG LEGACY - 9

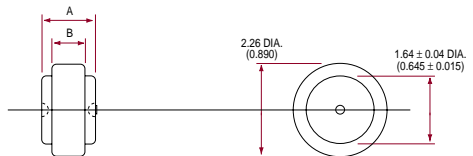

Three Electrode High-Energy Spark Gaps

SPECIFICATIONS

All characteristics at 25°C.

PART NUMBER	APPLIED DC VOLTAGE RANGE	MAIN STATIC DC BREAKDOWN (kV) KV ($\pm 10\%$)	PEAK CURRENT (KA) ⁽⁷⁾	DELAY TIME (μ S) ⁽⁸⁾	PACKAGE OUTLINE	DIMENSION A (INCHES)	DIMENSION B (INCHES)	DIMENSION C (INCHES)
TG-7	1.3 - 4.0	5.0	15.0	0.1	I-A	2.427 nom	0.228 max	1.500 max
TG-88	1.3 - 4.0	5.0	15.0	0.1	I-B	2.427 nom	0.228 max	2.015 max
TG-114	2.5 - 8.0	10.0	15.0	0.1	I-B	2.427 nom	0.228 max	2.015 max
TG-121	0.8 - 2.0	2.5	15.0	0.3	I-B/I-D	1.990 nom	0.228 max	1.450 max
TG-122	1.5 - 4.0	5.0	15.0	0.1	I-B/I-D	1.990 nom	0.228 max	1.450 max
TG-123	2.3 - 6.0	7.5	15.0	0.1	I-B/I-D	1.990 nom	0.228 max	1.450 max
TG-124	3.0 - 8.0	10.0	15.0	0.1	I-B/I-D	1.990 nom	0.228 max	1.450 max
TG-125	4.5 - 12.0	15.0	20.0	0.1	I-B/I-D	2.67	0.54	1.560
TG-126	6.0 - 16.0	20.0	20.0	0.1	I-B/I-D	2.67	0.54	1.560
TG-127	7.5 - 20.0	25.0	20.0	0.1	I-B/I-D	2.797 nom	0.540 max	2.051 max
TG-151	2.7 - 6.0	6.8	15.0	0.1	special	-	-	-
TG-177	0.6 - 1.9	2.5	10.0	0.3	III	1.625 max	0.520 \pm .030	0.300 \pm .025
TG-178	1.5 - 3.5	5.0	10.0	0.2	III	1.625 max	0.580 \pm .030	0.340 \pm .025
TG-179	3.0 - 8.0	10.0	10.0	0.1	III	1.719 max	0.620 \pm .030	0.380 \pm .025
TG-180	4.5 - 12.0	15.0	10.0	0.1	III	1.906 max	0.725 \pm .030	0.490 \pm .025
TG-181	5.3 - 14.0	17.5	10.0	0.1	III	1.906 max	0.725 \pm .030	0.490 \pm .025
TG-240	0.4 - 0.85	1.0	10.0	0.1	II	0.750 \pm .063	-	-
TG-241	0.5 - 1.25	1.5	10.0	0.1	II	0.750 \pm .063	-	-
TG-242	0.7 - 1.7	2.0	10.0	0.1	II	0.760 \pm .063	-	-
TG-243	0.8 - 2.1	2.5	10.0	0.1	II	0.760 \pm .063	-	-
TG-244	1.2 - 4.2	5.0	10.0	0.1	II	0.760 \pm .063	-	-
TG-245	2.0 - 6.2	7.5	10.0	0.1	II	0.760 \pm .063	-	-
TG-246	3.5 - 8.5	10.0	10.0	0.15	II	0.790 \pm .063	-	-
TG-247	4.5 - 11.0	12.5	10.0	0.15	II	0.790 \pm .063	-	-
TG-248	7.0 - 12.5	15.0	10.0	0.15	II	0.830 \pm .063	-	-
TG-1208	8.3 - 22.2	25.0 - 30.0	20.0	0.1	I-B	2.797 nom	0.515 \pm .020	2.051 max

⁽⁷⁾ The peak current is a conservative maximum for an approximately triangular pulse with a 50 μ s half-width.

⁽⁸⁾ Delay time is for Mode A operation when the applied voltage is 80% of the main static breakdown and the trigger pulse reaches 150% of the maximum trigger voltage.

ORDERING INFORMATION

A complete part number is represented by the information in the Part Number column of the specification table.

Three Electrode High-Energy Spark Gaps

MECHANICAL DIMENSIONS

DIMENSIONS
mm
(inches)

TG LEGACY - 1A

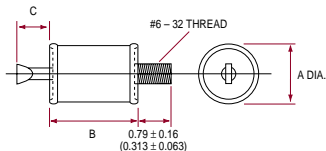

TG LEGACY 1-B

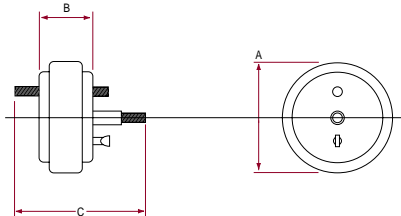

TG LEGACY 1-D

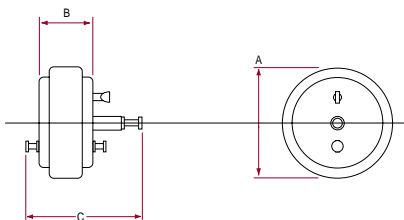

TG LEGACY II

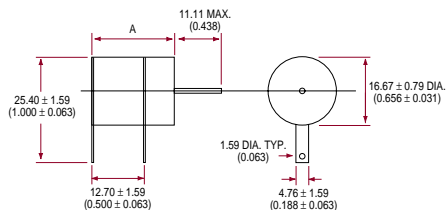

TG LEGACY - OUTLINE III

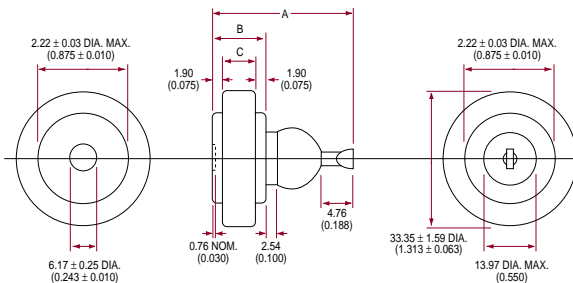



DESCRIPTION

CP Clare's TD Series of gas discharge microwave noise tubes and TN Series of gas discharge microwave noise sources are the element in a microwave RF system that allows accurate measurements of the noise figure of the receiver or its components. The requirements of a device used for making such noise figure measurements include broad bandwidth inherent in the active element, stability, ease of operation, and long life. In general, the range of usefulness of these noise sources permits measurements of noise figures from about 2 to 30dB. The PS-237 through PS-240 current-regulated power supplies can be used to operate many of the noise sources described herein.

FEATURES

- Excess noise ratios (ENR): up to 20dB
- Broad bandwidth
- Excellent long term stability
- Life up to 20,000 hours
- AC, DC, or pulsed operation

APPLICATIONS

- Noise figure measurement

SPECIFICATION RANGES

Parameter	Range	Units
Frequency	0.2 - 220.0	GHz
ENR	8.8 - 20.1	dB
Operating Current	30 - 250	mA
Starting Voltage	0.9 - 7.0	kV

(See detailed specifications for more data. Contact CP Clare for TD and TN part numbers or for other requirements not listed.)

MICROWAVE NOISE TUBES & NOISE SOURCES

TD/TN Series

TD SERIES GAS DISCHARGE NOISE SOURCE TUBES with Filamentary or Hollow Cathodes

All characteristics at 25°C.

FREQUENCY RANGE (GHz)	BAND	WAVE-GUIDE	PART # / EIA TYPE NUMBER	PACKAGE OUTLINE	MOUNT TYPE	RECOMMENDED MODE OF OPERATION ⁽¹⁾	MINIMUM STARTING VOLTAGE SPIKE (kV)	DC ANODE STARTING CURRENT (mA)	TUBE DROP (VDC)	TUBE-IN MOUNT ENR (dB)
1.12-1.70 (1.20-1.40 only)	L	WR-650	TD-21/6881	1	90°H	DC	4.0	250	65	15.20 ⁽²⁾
			TD-29/7101	1a	90°H	AC,DC	4.5	250	130	18.00 ⁽²⁾
			TD-33/7147	1a	90°H	AC,DC	4.0	250	75	15.20 ⁽²⁾
			TD-49	1	90°H	pulse	4.0	200	125	15.20 ⁽²⁾
			TD-62/7992	1	90°H	DC	4.5	250	~145	18.00 ⁽²⁾
			TD-75	1	90°H	pulse	4.5	200	235	18.00 ⁽²⁾
2.60-3.95	S	WR-284	TD-91	special	10°E	DC	7.0	250	230	15.20 ⁽²⁾
			TD-12/6358	2	10°E	DC	2.7	250	80	15.20
			TD-22/6782	special	90°H	AC,DC	2.0	250	45	8.85
			TD-31	2a	10°E	AC,DC	2.7	250	90	15.20
			TD-32	2a	10°E	AC,DC	2.7	250	170	17.80
			TD-34/7148	2	10°E	DC	2.7	250	160	17.75
			TD-38/8151	2	10°E	pulse	3.3	200	145	15.27
			TD-56/8286	2	10°E	pulse	3.5	200	265	17.90
3.30-4.90	S	WR-229	TD-82	special	90°E	DC	0.9	75	55	18
			TD-24	special	10°E	AC,DC	2.5	250	60	15.30
TD-30	special	10°E	AC,DC	2.5	250	110	1	15.30		
	3.95-5.85	C(G)	WR-187	TD-10/6356	3	10°E	DC	3.1	250	70
TD-39/7999				3	10°E	pulse	3.5	175	140	15.50
TD-43/8287				3	10°E	pulse	3.5	175	210	17.85
TD-48/7989				3	10°E	DC	2.7	250	135	17.70
TD-83				special	90°E	DC	0.9	100	55	18.90
5.85-8.20	X(J)	WR-137	TD-10/6356	3	10°E	DC	3.1	250	75	15.65
			TD-39/7999	3	10°E	pulse	3.5	175	140	15.50
			TD-43/8287	3	10°E	pulse	3.5	175	210	17.90
			TD-48/7989	3	10°E	DC	2.7	250	135	17.75
			TD-67/8288	3	15°E	pulse	3.5	150	225	18.00
8.20-12.40	X	WR-90	TD-11/6357	4	10°E	DC	2.7	200	75	15.60
			TD-23/6882	4	10°E	DC	2.7	200	115	18.00
			TD-40/8152	4	10°E	pulse	3.3	175	125	15.60
			TD-44/7988	4	10°E	pulse	3.5	175	205	18.00
			TD-58/8293	4	10°E	pulse	3.5	175	208	17.75
			TD-72/8059	4	10°E	pulse	3.3	175	133	15.56
			TD-73	special	90°E	DC	0.9	100	54	14.50
			TD-93B	special	90°E	pulse	0.9	100	165	14.50
			TD-114	special	10°E	DC	1.5	200	90	15.30
12.40-18.00	Ku	WR-62	TD-18/6684	5	10°E	DC	2.7	200	70	15.80
			TD-41/8030	5	10°E	pulse	3.3	175	130	15.85
			TD-46	special	20°E	AC,DC	~1.2	100	35	15.20 ⁽²⁾
			TD-54/7991	5	10°E	DC	2.7	200	130	18.00
			TD-55/8290	5	10°E	pulse	3.5	175	230	17.85
			TD-92	5	10°E	pulse	3.5	175	125	15.65
18.00-26.50	K	WR-42	TD-13/6359	6	10°E	pulse	2.7	200	68	15.90
			TD-42/8031	6	10°E	DC	3.3	175	125	16.00
			TD-50/7990	6	10°E	pulse	2.7	200	157	18.05
			TD-51/8291	6	10°E	DC	3.5	175	260	17.90
			TD-81	special	10°E	DC	3.3	150	148	16.15
26.50-40.00	Ka	WR-28	TD-76/7993	special	10°E	DC	2.7	125	130	16.0
			TD-77/8292	special	10°E	pulse	3.0	100	175	16.0

⁽¹⁾DC operation — cathode at one end only.

AC,DC operation — cathodes at both ends.

Pulse operation — cathode at one end specially designed for pulse operation. If the anode current during the "on" time of a square wave pulse (>100μs duration) is nominally the same as the rated DC anode current, the tube drop during this period will be approximately the same as the rated DC tube drop.

⁽²⁾Excess noise ratio of tube only.

**TD SERIES GAS DISCHARGE NOISE SOURCE TUBES
with Indirectly-Heated Cathodes**

All characteristics at 25°C.

FREQUENCY RANGE (GHZ)	BAND	PART NUMBER/ EIA TYPE NUMBER	MINIMUM STARTING VOLTAGE SPIKE (kV)	DC ANODE CURRENT (mA)	TUBE DROP (VDC)	TUBE-IN-MOUNT ENR (dB)	USED IN MOUNT
3.4-3.6	S	TD-124	0.60	75	40	18.30	TN-65
2.9-3.1		TD-129	0.45	75	35	18.50	TN-71
2.7-2.9		TD-121	0.45	75	35	18.50	TN-72
8.2-12.4	X	TD-126	1.50	100	90	15.6	TN-130

OUTLINE DRAWINGS (Noise Source Tubes with Filamentary or Hollow Cathodes)

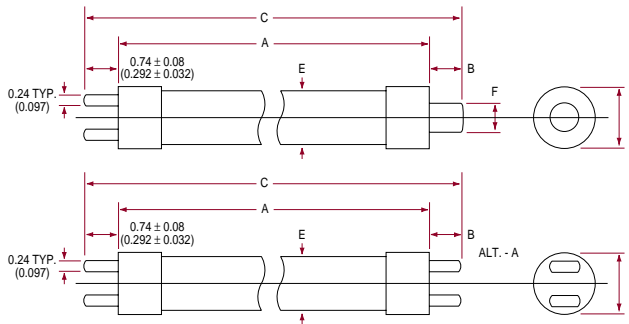

DIMENSION (INCHES)

OUTLINE NUMBER	A	B	C	D	E	F
1/1a ⁽³⁾	various	0.500 max	14.625-15.000	1.350-1.435	1.475-1.550	0.188 max
2/2a ⁽³⁾	16.937-17.437	0.310-0.360	17.625-18.000	0.990 max	0.975-1.050	0.305-0.325
3/3a ⁽³⁾	13.875-14.375	0.270-0.320	14.375-15.000	0.555 max	0.547-0.579	0.245-0.265

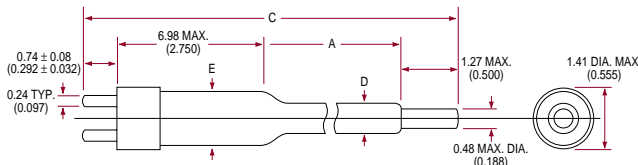

DIMENSION (INCHES)

OUTLINE NUMBER	A	B	C	D	E	F
4	8.625 min	1.500 max	11.937-12.250	0.370-0.380	0.550 max	0.3804
5	7.375 min	1.250 max	10.875-11.250	0.235-0.265	0.500 max	0.2654
6	6.187 min	1.250 max	9.687-10.000	0.160-0.194	0.500 max	0.1944

⁽³⁾The "a" suffix indicates using the bi-pin termination depicted in the inset labelled "ALT.-A".

⁽⁴⁾The diameter of the tube shall not exceed this value over the length of the tube denoted in the figure by "B".

MICROWAVE NOISE TUBES & NOISE SOURCES

TD/TN Series

TD SERIES GAS DISCHARGE NOISE SOURCE TUBES with Indirectly-Heated Cathodes⁽⁵⁾

All characteristics at 25°C.

BAND	PART NUMBER	FREQUENCY RANGE (GHz)	ENR (dB)	TUBE DROP (VDC)	DC ANODE CURRENT (mA)	MINIMUM STARTING VOLTAGE SPIKE (kV)	CIRCUIT LENGTH (INCHES)	MOUNTING	CIRCUIT
VHF	TN-46	0.2-0.25	18.5	200	30	1.5	15.50	Helical Coupling	7/8" coax
UHF	TN-47	0.56-0.64	20.3	325	50	2.0	16.5	Direct Coupling	7/8" coax
	TN-48	0.34-0.51	18.5	75		2.0	10.0	Helical Coupling	Type N
L	TN-51	1.0-2.0	20.1	200	50	1.9	8.94	Direct Coupling	7/8" coax
	TN-52	1.0-2.0	20.1	200	50	1.9	10.38	Direct Coupling	7/8" coax
	TN-54	1.0-2.0	20.5	200	50	1.9	17.31	Direct Coupling	Type N
	TN-55	1.25-1.55	20.1	200	50	1.9	9.56	Direct Coupling	7/8" coax
	TN-57	1.28-1.35	20.5	225	50	1.9	12.56	Direct Coupling	7/8" coax
S	TN-60	2.0-4.0	18.5	200	50	1.9	10.38	Direct Coupling	7/8" coax
	TN-64	2.7-2.9	18.5	35	60	0.45	3.75	90°E	RG-75/U
	TN-65	3.4-3.6	18.3	40	75	0.6	2.50	90°E	RG-75/U
	TN-71	2.9-3.1	18.5	35	75	0.45	3.63	90°E	RG-75/U
	TN-72	2.7-2.9	18.5	35	75	0.45	3.09	90°E	RG-75/U
	TN-73	2.7-2.9	18.5	35	75	0.45	3.09	90°E	RG-75/U
	TN-74	2.7-2.9	18.5	35	60	0.45	3.75	90°E	RG-75/U
	TN-75	3.1-3.5	18.3	40	75	0.6	2.63	90°E	RG-75/U
C	TN-76	5.3-6.0	18.5	60	150	0.7	2.00	90°E	RG-49/U
	TN-77	5.3-6.0	13.5	60	150	0.7	3.50	90°E	RG-49/U
	TN-78	5.45-5.82	18.5	60	150	0.7	2.75	90°E	RG-95/U
	TN-82	5.3-6.0	13.5	60	150	0.7	3.56	90°E	RG-49/U
H	TN-83	7.5-8.6	18.5	60	75	0.8	1.56	90°E	RG-51/U
	TN-84	7.5-8.6	15.0	55	100	0.8	2.50	90°E	RG-51/U
X	TN-94	8.9-9.1	18.5	50	60	0.95	1.63	90°E	RG-67/U
	TN-95	8.5-9.6	14.5	50	100	0.95	2.50	90°E	RG-67/U
	TN-97	8.5-9.6	18.5	50	75	0.95	1.63	90°E	RG-67/U
	TN-101	8.5-9.6	14.5	50	100	0.95	2.25	90°E	RG-52/U
	TN-124	8.2-12.4	12.5	50	50	1.00	2.50	90°E	RG-52/U
Ku(K)	TN-102	15.0-16.5	18.5	60	40	1.2	1.50	90°E	RG-67/U
	TN-103	12.4-18.0	18.5	140	50	2.0	7.50	0°E	RG-107/U
	TN-104	15.0-16.6	12.3	95	50	1.0	1.63	90°E	RG-91/U
	TN-128	12.0-14.0	13.5	50	50	1.0	2.00	90°E	RG-91/U
K(P)	TN-106	18.0-26.5	18.5	175	50	1.9	6.44	0°E	RG-66/U
	TN-125	22.0-23.0	12.5	65	50	1.5	2.25	90°E	RG-53/U
Ka(Q)	TN-107	26.5-40.0	18.0	140	40	2.5	5.13	0°E	RG-96/U
	TN-109	34.0-36.0	18.0	140	35	2.5	7.38	0°E	RG-96/U
	TN-126	31.0-32.0	13.3	75	50	1.5	2.25	90°E	RG-96/U
R	TN-111	50.0-75.0	18.0	230	30	2.5	4.63	0°E	RG-98/U

⁽⁵⁾ CP Clare can usually refurbish noise sources (depending on condition of waveguide) and install replacement tubes.

TD SERIES GAS DISCHARGE NOISE SOURCE TUBES with Filamentary Cathode Noise Tubes⁽⁵⁾

All characteristics at 25°C

WAVE-GUIDE	PART NUMBER (GHz)	FREQUENCY RANGE (dB)	APPROX. ENR (VDC)	TUBE DROP (mA)	DC ANODE CURRENT VOLTAGE SPIKE (kV)	MINIMUM STARTING	REPLACEMENT TUBE	MOUNTING MATE	FLANGE
WR-42	TN-170	18.0-26.5	15.0	170	120	2.0	TD-170	7°E	UG-595/U
WR-28	TN-162	26.5-40.0	15.4	170	120	2.0	TD-162	7°E	UG-599/U
WR-22	TN-172	33.0-50.0	15.4	170	120	2.0	TD-172	7°E	UG-599/U
WR-19	TN-163	40.0-60.0	15.4	170	120	2.0	TD-163	7°E	UG-385/U
WR-15	TN-164	50.0-75.0	15.0	170	120	2.0	TD-164	7°E	UG-385/U
WR-12	TN-171	60.0-90.0	15.0	210	100	2.5	TD-171	7°E	UG-385/U
WR-10	TN-165	75.0-110.0	14.2	225	75	3.0	TD-165	7°E	UG-385/U
WR-8	TN-167	90.0-140.0	13.0	225	75	3.0	TD-167	7°E	UG-385/U
WR-6	TN-166A	110.0-170.0	13.0	225	50	3.0	TD-166A	7°E	UG-385/U
WR-5	TN-173	140.0-220.0	9.0	225	50	3.0	TD-173	7°E	UG-385/U

⁽⁵⁾ CP Clare can usually refurbish noise sources (depending on condition of waveguide) and install replacement tubes.

NOISE SOURCE POWER SUPPLIES with Current Regulation

PART NUMBER	FOR NOISE TUBES ⁽⁶⁾	AC INPUT	DC STARTING VOLTAGE (kV)	DC OPERATING CURRENT (mA)
PS-237	TN-162 thru TN-172 except TN-166A	115VAC, 60Hz	5.0	150
PS-238		220VAC, 50Hz	5.0	150
PS-239	TN-173, TN-166A	115VAC, 60Hz	5.0	120
PS-240		220VAC, 50Hz	5.0	75

⁽⁶⁾ These power supplies, though designed for the TN-162 through TN-173, are capable of operating many other noise sources made by CP Clare.

ORDERING INFORMATION

A complete part number is represented by the information in the Part Number column of the specification table.

Why use surge protection?

Surge protectors protect personnel and equipment from damaging high-voltage surges from lightning, inductive switching, nuclear electromagnetic pulse, electrostatic discharge, or interference from power supply lines.

From a design point of view, protection circuits only cost money and, if customer requirements or regulatory agencies do not require them, they will easily be forgotten. Yet, appropriate surge protection is beneficial. Protected equipment will not be affected by the high-voltage surges listed above. This will result in:

- Reduced field failures
- Improved product quality and reliability
- Reduced cost of quality

Through ongoing research and engineering improvements, Clare has developed a family of Surge Protection Products that offer impressive characteristics for a variety of applications. Four differentiating characteristics are found in every Clare Surge Protection Product:

- High surge current rating
- Long life
- Fast response
- Rugged construction

The figure below illustrates the cost effectiveness of adding surge protection by demonstrating the unit repair cost to break even over a range of return rates for added protection costs of \$0.50/unit and \$1.00/unit.

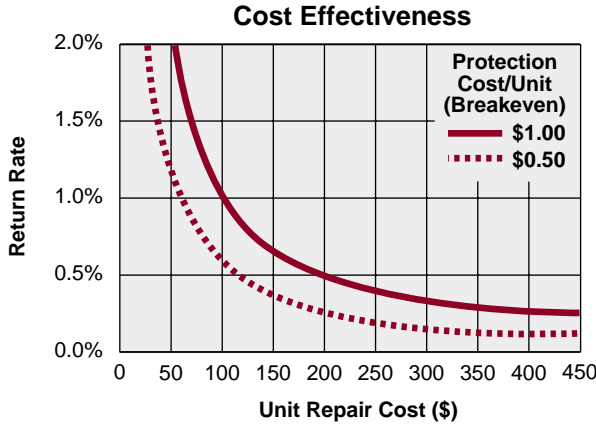

A Comparison of Surge Arrester Technologies

COMGAP GAS DISCHARGE TUBE ■ AIR GAP ■ CARBON BLOCK ■ SCR ■ ZENER DIODE ■ MOV

In today's world of sensitive electronics, an increasingly important topic has become the protection of electronic components from overvoltage surges. There is a multitude of devices on the market for this purpose but what are the differences between them and which is best for what application? The following describes, analyzes, and compares these devices in detail.

Basically there are two types of surge protection classifications with each consisting of its own group of devices:

CROWBAR

- Air Gap
- Carbon Block
- Gas Discharge Tube (GDT)
- Silicon Controlled Rectifier (SCR)

CLAMP

- Zener (Avalanche) Diode
- Metal Oxide Varistor (MOV)

CROWBAR PROTECTION

A crowbar device limits the energy delivered to the protected circuit by abruptly changing from a high impedance state to a low impedance state in response to an elevated voltage level. Having been subjected to a sufficient voltage level the crowbar begins to conduct. While conducting, the voltage across the crowbar remains quite low (typically less than 15 volts for gas discharge tubes usually higher for the air gap and carbon block protectors) and thus, the majority of the transient's power is dissipated in the circuit's resistive elements and not in the protected circuit nor the crowbar itself. This allows the crowbar to be able to withstand and protect loads from higher voltage and/or higher current levels for a greater duration of time than clamping devices.

AIR GAP PROTECTOR

An air gap protector consists of two conductive surfaces with a spacing between them that will permit an arc when a specified potential is placed across the surfaces. The air gap is not a sealed device and therefore it must operate at atmospheric pressure and

under the effects of the environment. Since the electrodes are exposed to the environment, they will often experience oxidation and corrosion which is not a problem common to a gas tube such as Clare's Comgap. These factors contribute to the air gap's high nominal breakdown voltage, wide breakdown voltage tolerance, and poor impulse response. Often an air gap is placed in parallel with a gas discharge tube or carbon block protector to provide back up protection in the event that the primary protection fails.

CARBON BLOCK PROTECTOR

A carbon block protector consists of a pair of carbon elements separated by a 0.003-0.004 inch air gap. When a specified potential is placed across the carbon surfaces an arc will be initiated. Like the air gap protector, the carbon block is an unsealed device and its performance suffers in the same manner as the air gap. Carbon block protectors are used mainly for telephone line protection but are being replaced, in most installations, with the more reliable and consistent gas discharge tubes.

Comgap GAS DISCHARGE TUBE

Clare's Comgap, a hermetically sealed gas filled ceramic tube with metal electrodes, is recognized for:

- Stable electrical parameters
- High insulation resistance
- Low capacitance
- High current capability
- Low leakage current
- Low arc voltages

For a gas tube to begin conduction, an electron within the sealed device must gain sufficient energy to initiate the ionization of the gas. Complete ionization of the gas takes place through electron collision. The events leading up to this phenomenon occur when a gas tube is subjected to a rising voltage potential. Once the gas is ionized, breakdown occurs and the gas tube changes from a high impedance state to a virtual short circuit and thus, any transient will be diverted from and will not reach the protected circuit. The arc voltage (the voltage across the gas tube while the gas tube is conducting) will typically be 15 volts. After the transient

A Comparison of Surge Arrester Technologies

has passed, the Comgap will extinguish and again appear as an open circuit. In order to insure gas tube turn off at the zero crossing in AC applications, the current through the Comgap once the transient has passed, must be less than the follow-on current rating of the gas tube. The follow-on current requirement can easily be met by placing a resistor in series with the gas tube. Clare's AC series of gas discharge tube surge arresters were developed specifically to protect AC power lines and normally will not require additional components to limit follow-on current. In DC applications, the gas discharge tube will extinguish as long as the device is operated within the specified holdover conditions. Holdover conditions involve the maximum bias voltage that can appear across a gas discharge tube under specified current conditions and still allow the gas discharge tube to turn off. Under normal operating conditions, the Comgap shunted across a circuit, will act like an open switch with a high insulation resistance.

second. The breakdown voltage response of a crowbar to transients with ramp rates of 1V/microsecond or less is referred to as the DC breakdown voltage level. Due to the nature of gas discharge tubes, the same gas tube will experience breakdown at a higher voltage as a transient's ramp rate increases. For example: At 100V/microsecond, the CG2-230L gas tube will breakdown at 600V maximum. The breakdown voltage response of a crowbar to transients with ramp rates greater than 1V/microsecond is referred to as the impulse breakdown voltage level.

Due to the Comgap's rugged construction, it can handle currents that far surpass other transient suppressors' capabilities - greater than 10 pulses of a 20,000 peak amperes pulse having a rise time of 8 microseconds decaying to half value in 20 microseconds (also referred to as an 8/20 wave form). The surge life of the Comgap is at least 1000 shots of a 500 amperes peak 10/1000 pulse. Because it is being used in a repetitive switching application, the ETS series Comgap has been designed for surge life greater than 100,000 shots. With a maximum inter-electrode capacitance of 1 picofarad, the Comgap can easily be designed into RF circuits. The Comgap is the practical device for the protection of telephone circuits, AC power lines, modems, power supplies, CATV and almost any application where protection from large and/or unpredictable transients is desired.

Comgap Gas Discharge Tube Voltage vs. Current Characteristics

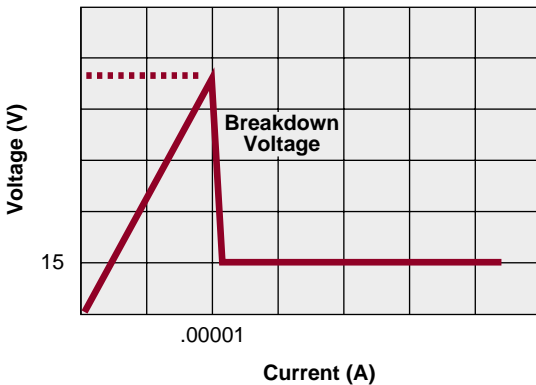

The Comgap's breakdown voltage is determined by electrode spacing, gas type (usually neon and/or argon), gas pressure (less than atmospheric), and the rate of rise of the transient. Breakdown voltage is defined as that voltage at which a crowbar type of surge arrester changes from a high impedance state to a low impedance state. The Comgap series is categorized by the breakdown voltage of each gas tube when a slowly rising transient is applied. For example: Clare's CG2-230L gas tube will breakdown at 230V (+/- 15%) when subjected to a ramp with a rate of rise of 500V/

SILICON CONTROLLED RECTIFIER (SCR)

Unlike the crowbar devices discussed above, the SCR is a semiconductor. Like the Comgap, the SCR will have a very low voltage drop across it while conducting. The SCR does require a trigger signal when a surge is present before it can begin to conduct. This trigger signal is usually supplied through the use of a zener diode. Packages that combine the SCR and zener diode are now available. These packages are monolithic devices and often contain an SCR-type thyristor with a gate region that acts like the avalanche diode. Once triggered, the SCR begins to conduct, dropping the voltage across the zener diode to a value below the zener's operating voltage and thus causing the zener to stop conducting. The SCR will conduct until the applied voltage drops to zero (zero crossing of AC) or until the current falls below a specified value (sometimes referred to as a holding current).

A Comparison of Surge Arrester Technologies

SCR Voltage vs. Current Characteristics

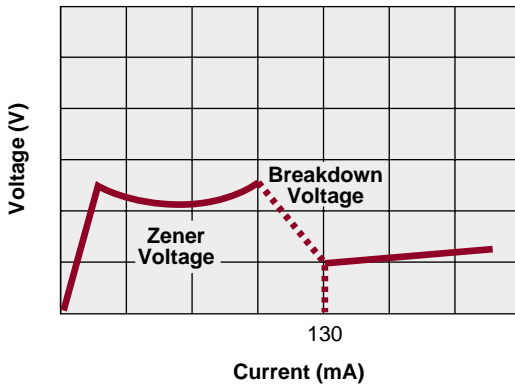

Although typically having a faster response time than a GDT, the SCR package is subject to higher leakage current and capacitance. The SCR package can handle currents of several hundred amperes of an 8/20 wave form and packages are available that offer bi-directional protection.

CLAMPING PROTECTION

A clamping device actually limits the voltage transient to a specified level by varying its internal resistance in response to the applied voltage. A clamping device must absorb the transient's energy and therefore, cannot withstand very high current levels. Although these devices have quick response times, they are subject to leakage currents and their capacitance values are higher than those found in the Comgap.

ZENER (AVALANCHE) DIODE

The zener diode comes closest to modeling the ideal constant voltage clamp. It responds quickly to a fast rising voltage potential and is available for a fairly wide range of clamping voltages (from less than 10 volts up to several hundred volts). The zener is placed in parallel with the circuit to be protected and will not operate until a surge exceeds the zener's breakdown voltage. The surge, causing the zener to conduct will be clamped to the zener's rated voltage. The zener is a good protector for circuits operating at low voltages. Caution is advised when designing the device into RF circuits due to the diode's high capacitance.

Also available are silicon avalanche suppressers which are referred to as transient voltage suppressers (TVS) diodes. These diodes consist of fairly large junction zeners which have been designed specifically for surge protection. The TVS diodes are rated for higher current surges than zener diodes and they can carry these currents for periods of 2-10 microseconds. For use in AC signal lines, two zeners are required. These are available as packaged devices. Avalanche diodes are often used to protect IC's from static discharge and other forms of transients in power supplies computer buses, and data lines.

Avalanche Diode Voltage vs. Current Characteristics

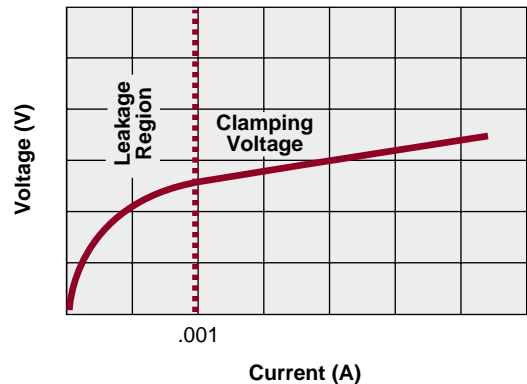

MOV (METAL OXIDE VARISTOR)

As its name suggests, the MOV is a voltage variable resistor made from sintered metal oxides. The grains produced in the sintered metal oxide material of the MOV can be thought of as a network of series and parallel diodes. As the voltage potential across the MOV increases, some of the diodes experience avalanche breakdown and begin to conduct and as a result, reduce the net resistance of the MOV.

The MOV can handle current pulses of higher peak values and for a longer duration than a diode, but the MOV can experience cumulative degradation and performance changes after it is exposed to large current pulses when not properly selected. The high peak current surges tend to fuse the oxide grains and thus alter the MOV's performance. Some engineers recommend that a fuse be used with an MOV as a large current surge could damage the grain structure, fuse

A Comparison of Surge Arrester Technologies

the grains together and result in the protected circuit being shorted out.

The MOV is available in a wide range of voltages and experiences a quick turn on time when subjected to a fast rising surge. The MOV is subject to leakage current and high capacitance (10's to 1000's of picofarads). When designing with a MOV it is necessary to remember that as the current through the device increases, the voltage which the MOV clamps at is greatly increased.

GDT and MOV PROTECTION

In summary, there is no one ideal surge arrester device type that meets all of the key performance parameters for every application. Due to their complementary performance characteristics, however, a GDT and MOV can be combined in a circuit to provide the ultimate in surge suppression performance. The MOV quickly clamps a fast rising voltage surge while the GDT crowbars to safely dissipate the large peak current to ground. (See Application Note entitled "Surge Protection of AC Power Lines".)

**MOV
Voltage vs. Current Characteristics**

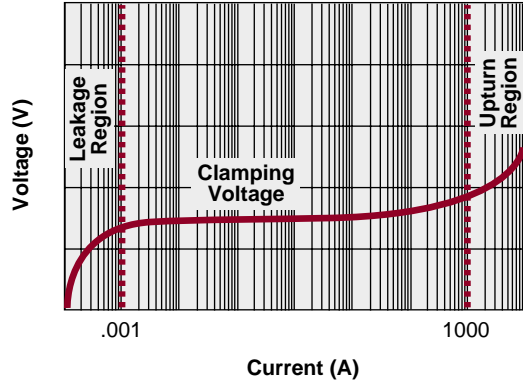

SUMMARIZED COMPARISON OF TECHNOLOGIES

	GAS TUBE CG2-230L	SCR	MOV	DIODE
Type of Device	CROWBAR	CROWBAR	CLAMP	CLAMP
Response Speed	<1 uSEC.	<100nSEC.	<100nSEC.	<100nSEC.
Capacitance	1pF MAX.	50pF	45pF	50pF
Leakage Current	<1 pAMP	50 nAMPS	10,000 nAMPS	10,000 nAMPS
Maximum Surge Current (8/20 μsec wave form)	20,000 AMPS	500 AMPS	200AMPS	50 AMPS
Relative Cost	\$1.00	\$1.50	\$0.50	\$1.50

The CLARE product engineering department provides objective technical expertise and application assistance to designer's of switching the surge protection systems. Our mission is to assist you in designing the best solution to your specific application problem, regardless of manufacturer. To access our team of engineering professionals call toll free 1-800-CPCLARE.

Basic Construction and Theory of Gas Discharge Tubes

Construction

Gas Discharge Tube (GDT) surge arresters commonly employ hermetically-sealed enclosures utilizing either ceramic-to-metal or glass-to-metal seals. The many advantages of ceramic-to-metal units have made them the norm for gas discharge tube surge arresters such as Clare's Comgaps. Along with being low cost, they offer high product uniformity capable of handling extreme levels of shock, vibration, and temperature.

The ceramic for Comgaps is alumina ranging from 94-98% Al_2O_3 . The ceramic-to-metal seals are prepared by moly-manganese or tungsten metallizing processes with nickel plating and the final seal is made in a gas-filled vacuum furnace using braze preforms made of copper-silver eutectic. The electrodes used for Comgaps are either copper or a nickel-iron alloy, often with a coating to lower the work function and/or add gettering capability. Stripes or bands of semi-conductive material are applied to the inner surfaces of the ceramic to improve stability and high-speed response.

In contrast, most devices in Clare's High Energy Devices product line are glass-to-metal units. This allows greater flexibility in configuration and is ideal for the production of standard and custom parts in more limited quantities. The electrodes of High Energy Devices are usually made of refractory metals such as tungsten or molybdenum to meet more extreme life and surge capacity requirements.

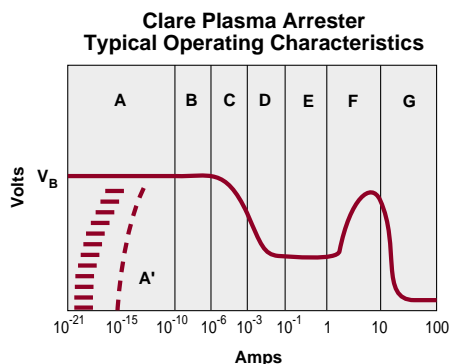

Figure 1. A generic V-i characteristic of a plasma device.

Theory

The basic operation of gas tube surge arrestors such as Clare's Comgaps is best understood by referring to the schematic form of the voltage-current (V-i) relationship of a generic gas discharge device such as the one depicted in Figure 1.

Description of Regions of a Generic V-i Characteristic of a Plasma Device

- A For voltages below the breakdown voltage, the gas provides a good insulator. Very low leakage currents (10^{-12}A) occasionally encountered result from ionization by cosmic rays, high energy photons, etc; and is, therefore, subject to statistical fluctuations.
- A¹ The current is higher due to supplementary electron sources such as photoemission.
- B The discharge is self-sustaining due to gas ionization –if external agents such as those mentioned for regions A and A¹ are removed, the current will not change (Townsend discharge). This occurs at the breakdown voltage of the device.
- C The transition region. As the electric field increases, more secondary electrons are generated, decreasing the voltage drop until the glow voltage (region D) is reached. Stable operation can only be maintained with active current regulation because of the negative slope of the V-i characteristic.
- D The glow region (or normal glow region). In this region, the glow voltage is roughly constant with respect to small changes in current.
- E The abnormal glow region. In contrast to the normal glow region, the glow voltage begins to increase as the current is increased.
- F The glow-to-arc transition region.
- G The arc region. In this region, the arc voltage will quickly drop and the arc current will quickly increase within the limitations of the drive energy and impedance.

Basic Construction and Theory of Gas Discharge Tubes

If the current through the gas discharge device is adjusted over the range of values of 10^{-18} to 10^2 amps, the voltage across the device will also vary. When a gas discharge device is operated as a transient voltage protector, the modes of operation of greatest significance are in regions A, F, and G. The applied voltage is normally less than the breakdown voltage of the device, V_{BD} , at which time the current through the device is in the A region. The charged carriers of electric current in this mode originate from the cathode by photon emission and within the fill gas by collisions of gas particles with cosmic rays (or radioactive decay particles if an isotope is used in the device).

As soon as the applied voltage across the device exceeds the breakdown voltage, the current through the device increases rapidly to values of several amps or greater. The rate of current rise and the level reached is limited by the source capacity and the series impedance of the circuit. The voltage across the device at this time is very low with typical values of 20V or less.

Surge Protection of Main Distribution Frame

Transient voltages induced in the telecommunication cable network can cause considerable damage to main distribution frame and telecommunication equipment. Effective surge protection can avoid expensive repair work and improve product reliability.

This article describes the possible transient sources which can occur on the telecommunication network and how to take preventive protective measures on the main distribution frame, based on tests and practical experience.

INTRODUCTION

Modern telephone systems are fast, efficient, and complex. Many developments have been made in control office equipment which involve solid state circuitry.

Unfortunately, solid state devices are much more susceptible to malfunction or failure due to transient voltages. In addition, the increased usage of telephone lines for data transmission has produced a further intolerance for transient voltages.

Telephone networks, having a wide cable distribution, are highly exposed to voltage transients and therefore require protection components with maximum power capability, long life and high reliability.

For these reasons gas discharge tube (GDT) surge arrestors find an increasing use as the primary protector in telephone systems, replacing older types of protectors (air gaps, carbon blocs) and being designed into nearly all new and future equipment systems.

CAUSES AND EFFECTS OF TRANSIENTS ON TELEPHONE EQUIPMENT

Direct Lightning Strike

The earth's surface continuously experiences electrical disturbance activities. The extent of this activity is significant as it is estimated that 100 lightning flashes strike the earth every second. It is therefore not surprising that lightning is the most common source of overvoltage surges in communication systems.

The effects of a direct lightning strike are devastating. It has been estimated that the energy dissipation per unit length of channel in a single lightning stroke is 100 KJ/m. The average length of a lightning stroke is 3 km. The average duration of a stroke is 30µs with 4 strokes per lightning. Therefore, the peak power per stroke is $1 \times 10^{13} \text{W}$.

The destructive power of lightning arises from high pressure generated in the lightning channel. In open air, energy deposited by a single stroke is equivalent to approximately 22g of TNT per meter, or 1/10 ton of TNT for the average channel. Most of this energy, however, is converted along the lightning channel leaving only a fraction of it at the end of the channel.

Four lightning parameters have to be considered when studying the effects of direct lightning strikes:

- Current amplitude (I): responsible for ohmic voltage drop in earth ground resistance.
- Steepness of the lightning current rise (di/dt): determines inductive voltage drops.
- Electric charge (∫idt): is a measure of the energy transmitted by the lightning arc to metallic surfaces, causing melting effects.
- Current square impulse (∫i²dt): is at the base of every mechanical effect and electrical impulse heating of ohmic resistors.

Table 1. Lightning Parameters

Percent of strokes	90%	50%	10%
Crest current i	2-8kA	10-25kA	40-300kA
Rate of current rise di/dt	2kA/µs	8kA/µs	20-300kA/µs
Duration of single pulse	100-600µs	0.5-3ms	20-400ms
Total stroke duration	10-100ms	100-300ms	0.5-1.5s
Number of pulses per stroke	1-2	2-4	5-34

Reference: Ezell, T.F., survey of lightning characteristics SC-TM-67-630 (August 1976).

Surge Protection of Main Distribution Frame

Indirect lightning:

The most noticeable and frequent interference in telephone systems is due to the inductive effect of lightning strikes. Although the induced effect of lightning is more common on overhead lines, buried lines are still susceptible through resistive coupling.

Overvoltages, mostly induced by cloud-to-cloud discharges, can be as high as several kilovolts with kiloamperes short circuit current. The surge voltage that appears at the end of the cable depends on the distance to the source, the type of cable, the shield material, and its thickness and insulation, along with the amplitude and waveshape of the lightning current in the shield.

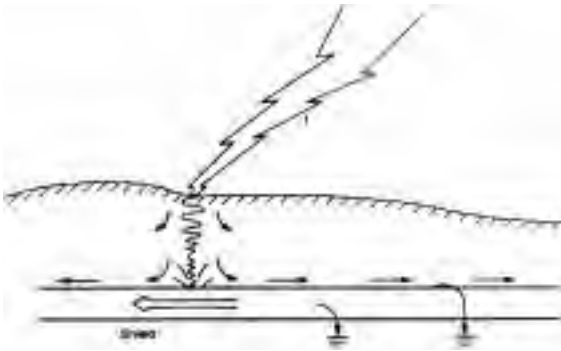

Figure 1. Indirect Lightning in Buried Cables

Power System Induced Transients:

Overhead telephone lines often share a utility pole and ground wire with the commercial AC power system. Buried telephone and power cables often share the same trench. Because of this, three types of overvoltage transients induced into the telephone lines can occur in conjunction with power system faults:

- Power contact or power cross: power lines make direct contact with telephone cables.
- Power induction: electromagnetic coupling of a heavy fault in the power system (this can be solved with proper shielding).
- Ground potential rise: heavy ground currents of power system faults flow in the common ground connections and cause substantial differences in potential.

Protection engineers have defined the power cross situation as the most severe condition. Therefore, the many requirements call for the suppression device to withstand 10A rms for a duration ranging from 10 to 60 cycles of the power system frequency.

PROTECTION OF MAIN DISTRIBUTION FRAME

The telephone system is made up of a central switching network which interconnects the different subscribers through repeaters, multiplexers, and concentrators. The cable network which links the subscribers makes the system vulnerable to damaging transients. The cables consist of conductors in shielded cables, which are suspended on poles or buried in earth.

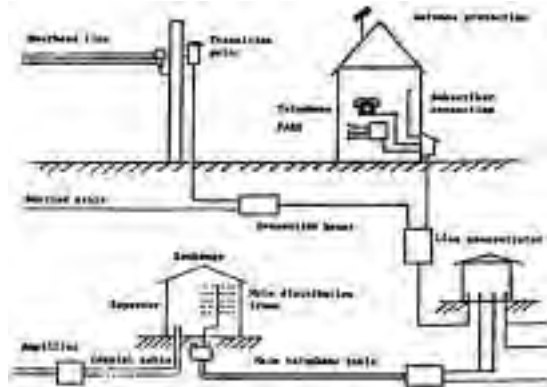

Figure 2. Telecommunications Network

Along with the cable network, antennas on wireless equipment connected to the telephone are also a potential source of transients to the network. Additionally, the power used by a telecom system is usually obtained from commercial power lines which are subjected to the same possible overvoltage surges as the telephone lines.

As one can see, the complexity and exposure of the telephone system makes it highly susceptible to all types of overvoltage transients. From a practical standpoint, however, the cost of installing and maintaining a 100% protection system would not be cost effective. Therefore, network planners usually develop a location's network protection level plan based upon the implementation cost, stroke factor, ground resistance, type of facilities, desired reliability of service, and the exposure to lightning.

Surge Protection of Main Distribution Frame

The main distribution frame (MDF) (see figure 3) is the link between the cables coming from anywhere in a local telephone network and the cable coming from the exchange switching equipment. The MDF rack consists of tubular and angular rails for the various MDF devices to be attached. On the line side (mostly accommodated on vertically rails), local cables are terminated. On the exchange side, horizontal arranged terminal blocs are connected to the exchange switches. An overvoltage protection magazine installed on the line side protects the exchange switching equipment against harmful overvoltage transients when connected to the external cable network.

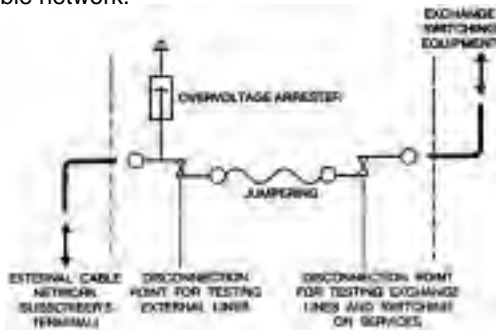

Figure 3. Main Distribution Frame

Protecting the MDF with GDTs:

Of the devices available for transient protection, the gas discharge tube (GDT) protector reliably offers the highest surge current dissipation that is required to protect against lightning. GDT devices are unique in their ability to handle transient currents many times beyond the capability of solid state devices.

In the presence of a fast rising voltage surge, the GDT crowbars (switches) from its normally high impedance state to short circuit the transient safely to ground. Once in their fired state, GDT surge arrestors act like low voltage clamping devices (10-20V) whose clamping voltage is essentially independent of the transient's current magnitude. In the non-operating mode, the GDT surge arrestors are essentially transparent to the network's performance since they offer extremely high isolation resistance and very low line capacitance.

For these reasons the GDT arrester can be considered the best solution to provide the telephone network the primary protection against direct or induced high voltage transients.

Typical performance requirements of the GDT protector are:

- Environmental:
 - Temperature: -40 to +90°C
 - Relative Humidity: up to 95%
- Electrical:
 - DC Breakdown: 250V nominal
 - Impulse Breakdown at 100 V/μs: 900V max.
 - Insulation Resistance: > 1000 MΩ
 - Capacitance: ≤5pF
- Life Tests:
 - Impulse 8/20, 10 shots, 10 kA peak
 - Impulse 10/1000, 300 shots, 100A peak
 - AC, 15-62 Hz for 1 sec., 5 shots, 10A rms

In many situations, a fail safe system is specified on GDT devices so the line is permanently grounded after excessive heating of the surge arrester by an extensive power cross. If this situation occurs, the GDT device and fail safe mechanism must be replaced.

Two Electrode Configuration:

CP Clare's Comgaps are used in many telecommunication networks around the world for main distribution frame protection. The Comgaps are constructed of two metal electrodes hermetically sealed in a gas filled, rugged ceramic cylinder. Through ongoing research and engineering improvements, CP Clare has developed a variety of surge arrester families that offer impressive characteristics for MDF protection.

The two electrode CG2 series can best be used where microsecond transient rise times are expected. They provide fast response time, high holdover voltage and high follow-on current capacity.



Figure 4. Clare's Bipolar Comgaps

Surge Protection of Main Distribution Frame

CG-230L Performance:

Nominal DC Breakdown Voltage: 230 Vdc
 Impulse Breakdown at 100V/ms: 600V max.
 Insulation Resistance: 1000 M Ohm min.
 Maximum Capacitance: 1pF max.
 Surge Life:

- Impulse 8/20, 10kA, 10 shots
- Impulse 10/1000, 500A, 1000 shots
- AC, 15-62Hz for 1 sec., 10 shots, 20A rms.

CP Clare is ISO9000 certified and our automated production techniques are tightly controlled to assure a consistent, highly uniform product. Electrical testing is conducted on 100% of our products prior to shipment to our customers.

Three Electrode Configuration

In a telephone cable, signals are conducted through pairs of copper wires. Therefore, transient voltages induced into the conductors will be common to both signal wires (typically called “tip” and “ring”). This is shown in Figure 5A.

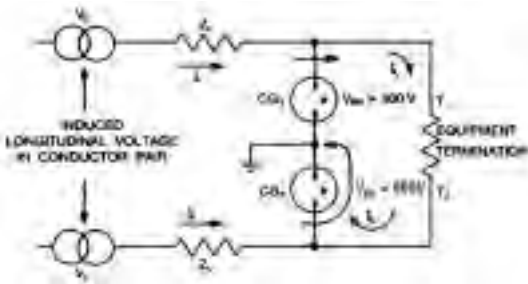

Figure 5a. Unbalanced Line Protection

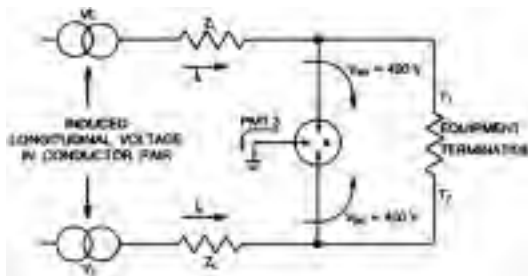

Figure 5b. Balanced Line Protection

If protector CG_1 should breakdown (V_{BR}) at 400V while CG_2 requires 600V to breakdown, the difference would cause a transient current to flow through the load. To eliminate the problem of unbalanced line breakdown, dual gap or three electrode tubes like the PMT3 and PMT8 have been developed. See Figure 5B.

The PMT3(310) series from Clare are three electrode, medium duty surge arrestors designed to protect electronic equipment from damage due to excessive voltages and current. The PMT3(310) products have extremely fast response times characterized by the impulse breakdown voltage, which describes their dynamic behavior. For ease of mounting on PC boards, the devices are available in many different lead configurations.



Figure 6. Clare's Tripolar Comgaps

PTM3(310)230-04 Performance

Nominal DC Breakdown Voltage: 230 Vdc
 Impulse Breakdown at 100V/ms: 600V
 Insulation Resistance: 1000 Mohm min.
 Maximum Capacitance: 1 pF max.
 Surge Life:

- Impulse 8/20, 10kA per side, 20kA total
- Impulse 10/1000, 500A, 400 shots
- AC, 15-62Hz for 11 cycles, 65A

The voltage rating of the surge arrester is determined by the voltage applied between the tip and ring signal wires. Most telecommunication systems have 48 Vdc with a super imposed ring voltage of 100V rms (154V peak) maximum which results in a minimum breakdown voltage of 202V. Therefore, the PMT3(310)230 or PMT8-230 would be appropriate three electrode selections for this application.

Surge Protection of Main Distribution Frame

Protection Verification

In actual field operation, surge arrester devices are subjected to transients which, by their nature, are unpredictable in magnitude and duration. In order to best simulate transients such as lightning, international committees have developed standard lightning wave shape tests which can be conducted to evaluate protection components. Figure 7 illustrates the standard characteristics of these wave slopes. CP Clare utilizes these recommendations and standards when specifying, qualifying, and testing our GDT devices.

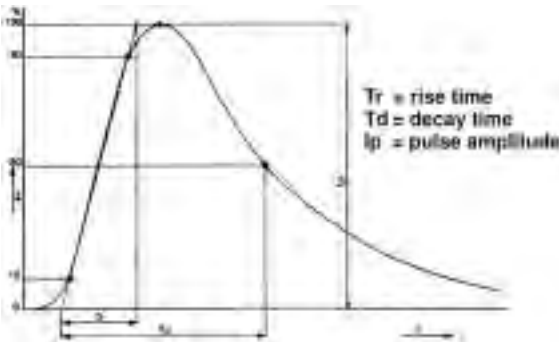

Figure 7. Description of Surge Current

Maintenance of Protection Devices

Most components utilized in lightning protection systems degenerate gradually due to the effects of repetitive surge damage and weather exposure. Component deterioration can cause a loss of protection resulting in unexpected system damage as well as performance degradation in the power and signal circuits. Periodic maintenance will help insure that the protection system remains at its original design and installation performance capability. Unlike semiconductor devices, the deterioration of GDT protectors can easily be measured. A GDT's performance can gradually degenerate due to erosion of its metallic electrodes. The degeneration, which is a function of lightning stroke frequency and magnitude, may easily be detected by measuring a lowering of the insulation resistance value across the electrodes of the device.

Surge Protection of AC Power Lines

AC power line disturbances are the cause of many equipment failures. The damage can be as elusive as occasional data crashes or as dramatic as the destruction of a power supply, computer terminal, or television set. Power line disturbances go by many names – transients, surges, spikes, glitches, etc. – but regardless of the name, an understanding of their characteristics and the operation of the various protection devices available is necessary to design an effective protection circuit. This Application Note will illustrate how to design high-performance, cost-effective surge protection for equipment connected to AC power lines. The role of gas discharge tube (GDT) surge arresters specifically designed for AC power line protection will also be discussed.

The first step in providing an effective defense against power line transients is to accurately characterize the transients. One good reference is IEEE C62.41-1991 entitled “IEEE Recommended Practice on Surge Voltages in Low-Voltage AC Power Circuits” (formerly IEEE Standard 587). This standard defines the open circuit voltage and short circuit current waveforms which can be expected to occur on AC power lines of 1000 Volts (RMS) or less. The standard defines three levels of increasing transient activity, labeled Location Categories A through C, dependent on the distance of the equipment from the service entrance. Line cord-connected equipment will usually be covered by Location Category A or, occasionally, Location Category B. There are two standard waveforms which define the types of transients expected in these Location Categories:

Test waveforms for evaluation of a surge protection system should conform to these standard waveforms as closely as possible to ensure valid results. The use of test waveforms having slower rise times or lower peak currents/voltages may result in a false sense of security concerning the level of protection actually provided under field conditions.

- 0.5ms-100kHz Ring Wave (see Figure 1A) — an oscillatory waveform having a peak open circuit voltage of up to 6kV[†], a risetime of 0.5ms, a ring frequency of 100kHz, and a “Q” of three. Though a short-circuit current is not specified, peak currents of up to 0.5kA can be expected.[†]
- 1.2/50µs-8/20µs Combination Wave (see Figure 1B) — a unidirectional impulse waveform having a peak open-circuit voltage of up to 6kV[†] with a rise time of 1.2µs and a duration of 50µs[‡] AND a peak short-circuit current of up to 3kA[†] with a rise time of 8µs and a duration of 20µs[§].

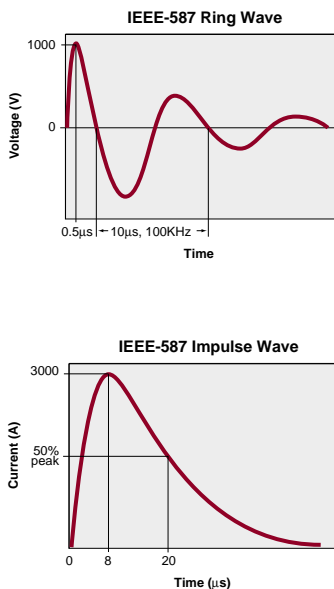

Figure 1. IEEE Test Waveforms

(A) 0.5µs-100kHz Ring Wave

(B) 1.2/50µs-8/20µs Combination Wave

The second step in designing an effective surge protection circuit is to choose which type(s) of surge protector to use. Surge protection devices can be divided into two basic types: Crowbar-type devices such as gas tube surge arresters, spark gaps, and SCRs; and Clamp-type devices such as avalanche diodes, transient absorption zener diodes, and metal oxide varistors. (See Application Note entitled “Comparison of Surge Protection Technologies”.)

Surge Protection of AC Power Lines

The clamp-type devices have faster response times but are limited in their current handling ability because most of the energy of the transient must be dissipated by the clamping device. Also, the voltage drop across a clamp-type surge protector increases with the conducted current as shown in Figure 2A.

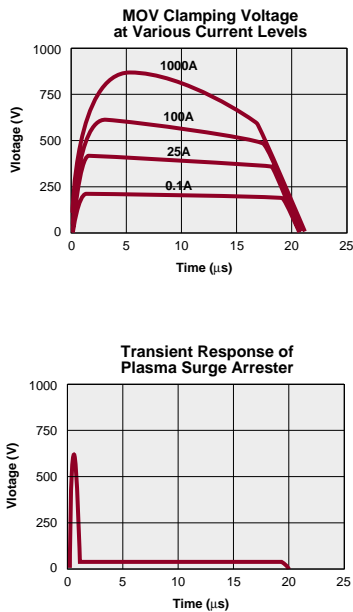

*Figure 2. Transient Voltage Drop
(A) For a Metal Oxide Varistor
(B) For a Gas Tube Surge Arrester*

Crowbar-type devices such as gas tube surge arresters have slightly slower response times but can handle much higher current because they act as a low impedance switch which diverts the transient energy away from the protected equipment to be dissipated externally. While the peak voltage experienced by the protected circuit during the leading edge of some transients may be higher than with a clamp-type device; the duration, and thus the total energy delivered to the protected circuit, is much lower when using a crowbar-type device as shown in Figure 2B.

This peak voltage is a function of the rise time of the leading edge of the transient. Faster rise times will result in higher peak voltages due to the response time of the protector. Although Zener-gated SCRs and thyristors are available which offer faster response times, their use is limited to telecom and signal line applications due to their relatively low peak current ratings. A major benefit of the gas tube surge arrester is that the voltage drop across the device remains essentially constant (<20V) regardless of the conducted current.

The ideal surge protector would overcome the current handling and energy diverting characteristics of the crowbar type device with the speed of the clamp type device. This approach has been difficult and expensive to realize with traditional crowbar type devices because their designs were optimized for the ability to turn off in the presence of a low-current DC bias. While that is appropriate for protecting a telecom line, additional components (such as a series resistor or parallel-connected series-RC network) were required to ensure that the gas tube surge arrester would extinguish when placed across an AC power line with its relatively low source impedance and the resultant follow-on currents.[#] These components invariably decreased the performance of the protector while increasing its installed cost.

These shortcomings have been resolved with the Clare's AC series of gas tube surge arresters specifically designed for AC power line applications. These devices provide the low impedance switching action and high peak current capabilities of traditional gas tube surge arresters while optimizing the ability to extinguish in the presence of AC follow-on currents in excess of 300A.

Surge Protection of AC Power Lines

Hybrid Surge Protection Circuit

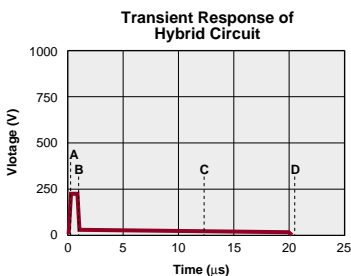
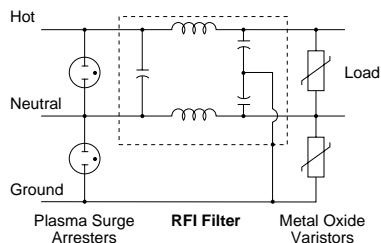

Figure 3. (A) A typical surge protection circuit. (B) Its response to a transient.

In most applications, no additional components are required other than those of the basic surge protection circuit. A surge protection circuit with sub-nanosecond response time, precise control of transient energy let-through, and a peak current rating of 20,000A is now practical even for cost-sensitive applications such as power supplies, home stereos, monitors, and printers.

A typical installation is illustrated in Figure 3A. This is a two stage hybrid circuit consisting of a gas tube surge arrester as the primary protector and a Metal Oxide Varistor (MOV) as the secondary protector². These elements must be separated by an isolating impedance. This impedance may be either resistive ($>10\Omega$) or inductive ($>0.1\text{mH}$) to ensure proper coordination of the protective devices. Most AC applications utilize an inductive element to minimize power dissipation and voltage drop during normal operation.

The inductor used in this example is part of the RFI filter already required by the design. The output of the protection circuit during a transient is illustrated in Figure 3B.

The following sequence of events is depicted in Figure 3B:

- A** The leading edge of the transient is clamped by the MOV to a value just above the normal operating voltage.
- B** As the current through the MOV increases, a voltage is developed across the inductor which causes the gas tube surge arrester to fire. The energy of the transient is now quickly shunted through the gas tube surge arrester and away from the protected circuit.
- C** The gas tube surge arrester remains in full conduction for the duration of the transient.
- D** When the transient has passed, the gas tube surge arrester extinguishes—ready for the next transient.

This circuit uses each component to do what each does best: the gas tube surge arrester diverts the high-energy portion of the transient and the MOV provides the fast, accurate clamping of the low energy leading edge.

The cost effectiveness of this protection circuit is enhanced by three factors:

1. The use of an AC Series gas tube surge arrester eliminates the need for additional components to ensure turnoff.
2. The isolating impedance is supplied by an existing component (the RFI filter).
3. A small diameter MOV (lowest cost) is used since the gas tube surge arrester handles the high-energy portion of the transient.

The example duplicates the circuit between Neutral and Ground in addition to the Hot-to-Neutral circuit. This provides protection against Common Mode (both lines surged relative to ground) as well as Normal Mode (Hot-to-Neutral) transients. This is important because both types of transients are frequent occurrences in the real world. The failure to provide Common Mode protection is one of the leading causes of failure in many otherwise solid designs.

Surge Protection of AC Power Lines

The critical points in the selection of the gas tube surge arrester are the minimum DC breakdown voltage (which must be higher than the highest normal voltage expected on the protected line) and the follow-on current rating (which must be higher than the expected fault current of the incoming supply line). In this example, the minimum DC breakdown voltage is calculated by multiplying the normal line voltage (120VRMS) by 1.414 to obtain the peak voltage and then adding an appropriate guard band to allow for normal variations in the supply voltage.

$$120\text{VRMS} \times 1.414 = 170\text{Vpeak}$$

$$170\text{Vpeak} \times 1.15 \text{ (15\% guardband)} = 196\text{V minimum}$$

The MOV should be selected using the same formula. When used in a properly designed hybrid circuit, a 3mm device is normally adequate to handle the small leading-edge currents until the gas tube surge arrester goes into conduction.

The inductor should have a value of at least 0.1mH. If the inductance is too low, the MOV may clamp the transient voltage at a level that does not allow the gas tube surge arrester to go into conduction. The result is usually the overloading and destruction of the MOV. Tests have been conducted using several common RFI filters having inductances or 1-2mH with excellent results.

Hybrid surge protection circuits incorporating AC Series gas tube surge arresters can provide cost-effective protection against transients that exceed even the tough guidelines of IEEE C62.41-1991 for Location Categories A and B.

Notes

- † The exact value is a function of the Location Category and System Exposure level. See the IEEE spec for more detailed information.
- ‡ The rise time for an open-circuit voltage waveform is defined as $1.67 \times (t_{90} - t_{30})$ where t_{30} and t_{90} are the 30% and 90% amplitude points on the leading edge of the waveform. The duration is defined as the time from the virtual origin, t_0 (where a line through t_{30} and t_{90} intersects the zero voltage axis), to the 50% amplitude point of the trailing edge of the waveform, t_{50} .
- § The rise time for a short-circuit current waveform is defined as $1.25 \times (t_{90} - t_{10})$ where t_{10} and t_{90} are the 10% and 90% amplitude points on the leading edge of the waveform. The duration is defined as the time from the virtual origin, t_0 (where a line through t_{10} and t_{90} intersects the zero current axis), to the 50% amplitude point of the trailing edge of the waveform, t_{50} .
- # If the current supplied by the AC power line exceeds the maximum follow-on current of the gas tube surge arrester (typically, ~20A), the device will continue to conduct, even at a zero crossing of the AC voltage signal, causing the gas tube surge arrester to overheat and fail.
- £ A transient absorption zener diode should also work as the secondary protector.

Spark Gaps for Energy Transfer Applications

Many applications in electronic circuits require a fast-acting switch capable of transferring stored electrical energy, usually from a storage capacitor to a load circuit. Typical applications include the following:

- Discharge Lamp Ignitors (HID or Glow Lamps)
- Gas Ignitors (Gas Dryers or Water Heaters)
- Pulsed Light Sources (Xenon Photo Flash)
- Exploding Bridge Wires (EBW)
- Crowbarring Power Supplies

When the voltage level is low (<100V) and currents do not exceed 1A, transistor circuits may be used. When the voltages exceed several hundred volts and currents exceed 1-10A, spark gaps become especially suitable in terms of cost, size, standby readiness, and minimum associated circuit requirements. Spark gaps may be designed to handle extremely high currents for short durations and at high voltage levels while still contained in a relatively small space. These devices can operate over wide temperature extremes (as great as -55°C to +125°C), they are unaffected by variations in pressure and humidity, and can withstand high levels of shock and vibration. Since these devices are made for cold cathode operations, no heater circuits or standby power is required.

A two-electrode spark gap requires the least amount of associated circuitry (see Figure 1A). For energy transfer, the storage capacitor must begin to charge from time zero until the breakdown voltage of the “switch” is reached. At this point, the impedance of the spark gap quickly drops from several thousand megohms to a few ohms and the storage capacitor discharges at a rate limited by the circuit impedance. (For more information, please see our Application Note entitled “Use of Energy Transfer Switches”).

In applications where “instantaneous” switching is required, a triggered spark gap is used (see Figure 1B above). Here, the storage capacitor is charged prior to the energy demand. Since the self-breakdown voltage of the triggered spark gap is greater than the charge voltage of the storage capacitor, the storage capacitor remains charged. Upon application of an appropriate trigger pulse, the “switch” will rapidly close (typically 0.1μs delay time) and the stored energy will be transferred to the load circuit. (For more information, see our Application Notes entitled “Use of Triggered Spark Gaps”).

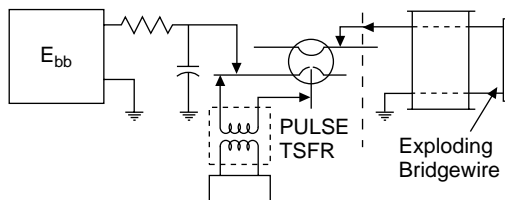
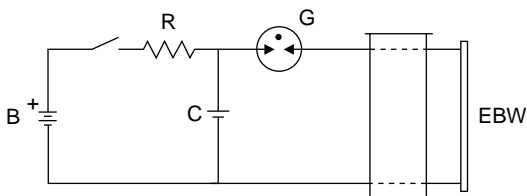

Figure 1. Connection of Two-Electrode (A) and Triggered (B) Spark Gaps for Energy Transfer.

Use of Energy Transfer Switches

The Energy Transfer Switch (ETS) gas discharge tube product line from CP Clare has been developed to provide a cost-effective device for switching applications requiring:

- Long life when subjected to low energy discharges
- Narrow firing voltage limits over life
- Low cost
- Rugged construction

Typical applications for Energy Transfer Switches include:

- HID lamp ignitor
- Glow discharge ignitor
- Gas ignitor
- Flash tube trigger

Each of these applications uses the Energy Transfer Switch in a relaxation oscillator similar to the generic HID lamp ignitor circuit depicted in Figure 1 below. The storage capacitor must begin to charge from time zero until the firing voltage of the Energy Transfer Switch is reached. At this point, the impedance of the Energy Transfer Switch quickly drops from several thousand megohms to a few ohms and the storage capacitor discharges at a rate limited by the circuit impedance. The current through the primary of the pulse transformer creates the high voltage ignition transient across the secondary of the transformer.

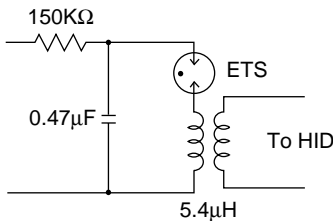

Figure 1. Generic HID lamp ignitor circuit using an Energy Transfer Switch.

The engineers at CP Clare have developed custom instrumentation for conducting automated life testing of Energy Transfer Switches in customer-supplied modules where every firing voltage is recorded for up to 100,000+ shots. Two typical life test regimens are:

Continuous Repetitive Pulses

Typically in this test regimen, there is continuous firing at a slow rate (< 0.5 pulses/second).

Repetitive Pulse Bursts

Typically in this test regimen, there is a brief (< 1 second) burst of up to 30 fires followed by a longer pause (5-10 seconds).

Entire waveforms including a single charge-discharge cycle (continuous) or a burst of charge-discharge cycles (burst) are recorded during each life test. Subsequent post-processing determines the voltage of each firing for plotting and analysis. Below is a graph depicting actual life test data for an Energy Transfer Switch.

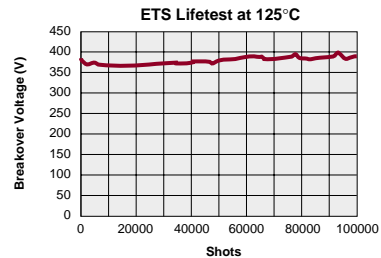

Figure 2. Typical life test plot for an Energy Transfer Switch.¹

As illustrated in Figure 2 above, the firing voltage does not vary greatly over the 100,000 shots.

Notes:

¹ The circuit used for this life test had $V_{ps}=450V$, $R=68k\Omega$, and $C=0.47\mu F$ with the primary of the pulse transformer simulated by a $5.4\mu H$ inductor (yielding a 250 Amp peak discharge current, a initial pulse width of $0.7\mu s$, and a nominal relaxation frequency of 15 pulses/second). The test was performed in repetitive burst mode with 0.7 second bursts and a 10 second delay between bursts at 25°C.

IEC-1000-4 Application Notes

Electromagnetic Compatibility for Industrial- Process Measurement and Control Equipment

Introduction

The purpose of the IEC 1000-4 (previously known as IEC-801) standard is to establish a common reference for evaluating the performance of industrial-process measurement and control instrumentation when exposed to electric or electromagnetic interference. The types of interference considered are those arising from sources external to the equipment.

The interference susceptibility tests are essentially designed to demonstrate the capability of equipment to function correctly when installed in its working environment. The type of test required should be determined on the basis of the interference to which the equipment may be exposed when installed while taking into consideration the electrical circuit (i.e., the way the circuit and shields are tied to earth ground), the quality of shielding applied, and the environment in which the system is required to work.

The IEC 1000-4 standard is divided into six sections:

- IEC 1000-4-1. Introduction
- IEC 1000-4-2. Electrostatic Discharge Requirements
- IEC 1000-4-3. Radiated Electromagnetic Field Requirements
- IEC 1000-4-4. Electrical Fast Transient (Burst) Requirements
- IEC 1000-4-5. Surge Voltage Immunity Requirements
- IEC 1000-4-6. Immunity to Conducted Disturbances Induced by Radio Frequency Fields Above 9KHz

Sections IEC 1000-4-2 through IEC 1000-4-5 will be discussed in this application note.

Test Severity Level

Level	Test voltage: Contact discharge	Test voltage: Air discharge
1	2kV	2kV
2	4kV	4kV
3	6kV	8kV
4	8kV	15kV
x	Special	Special

"x" is an open level.

The test severity levels shall be selected in accordance with the most realistic installation and environmental conditions.

Characteristics of the ESD generator

Level	Indicated voltage	First peak current of discharge (+/- 10%)	Rise time with discharge switch	Current at 30 ns (+/- 30%)	Current at 60 ns (+/- 30%)
1	2kV	7.5A	0.7 to 1 ns	4 A	2 A
2	4kV	15 A	0.7 to 1 ns	8 A	4 A
3	6kV	22.5 A	0.7 to 1 ns	12 A	6 A
4	8kV	30 A	0.7 to 1 ns	16 A	8 A

Electrostatic Discharge (ESD) Requirements

The purpose of this test is to find the reaction of the equipment when subjected to electrostatic discharges which may occur from personnel to objects near vital instrumentation.

In order to test the equipment's susceptibility to ESD, the test set-up conditions must be established. Direct and indirect application of discharges to the Equipment Under Test (EUT) are possible, in the following manner:

- a) Contact discharges to the conductive surfaces and to coupling planes.
- b) Air discharge at insulating surfaces.

Two different types of tests can be conducted:

1. Type (conformance) tests performed in laboratories.
2. Post installation tests performed on equipment in its installed conditions.

The only accepted method of demonstrating conformance to the standard is the of type tests performed in laboratories. The EUT, however, shall be arranged as closely as possible to the actual installation conditions.

Examples of laboratory ESD test set-ups can be seen in Figure 1 for table-top equipment and in Figure 2 for floor standing equipment.

IEC-1000-4 Application Notes

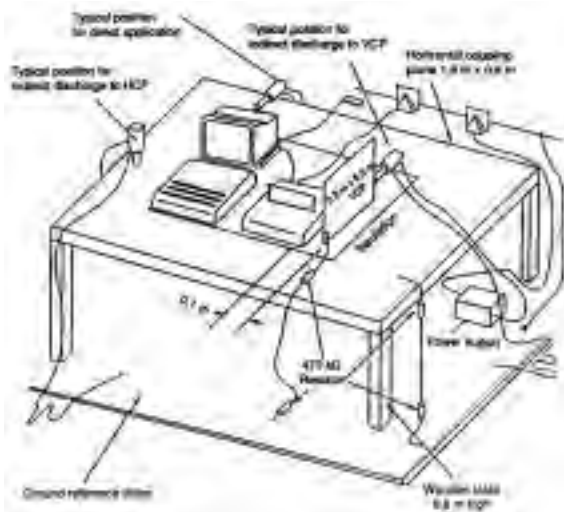

Figure 1. Example of test set-up for table-top equipment, laboratory tests.

Post installation tests are optional and not mandatory for certification. If a manufacturer and customer agree post installation tests are required, a typical test set-up can be found in Figure 3.

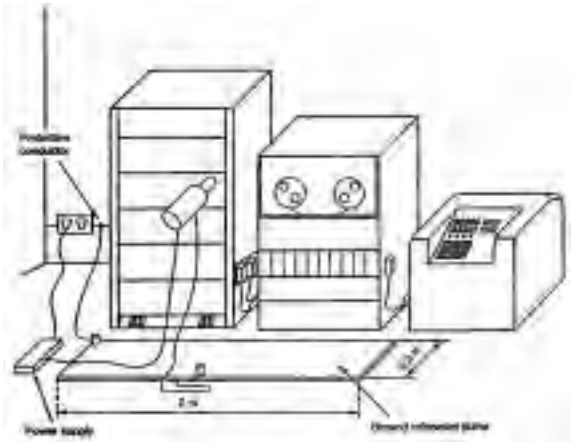

Figure 3. Example of test set-up for equipment, post-installation tests.

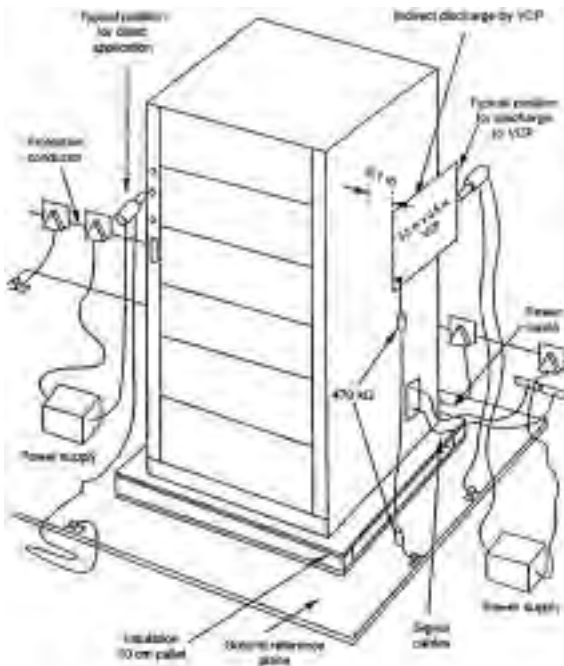

Figure 2. Example of test set-up for floor-standing equipment, laboratory tests.

Test Procedure

- For conformance testing, the EUT shall be continually operated in its most sensitive mode which shall be determined by preliminary testing.
- The test voltage shall be increased from the minimum to the selected test severity level.
- Number: at least 10 single discharges (in the most sensitive polarity).
- Time interval: initial value 1 second, longer intervals may be necessary.
- Direct application of discharge to the EUT: The static electricity discharges shall be applied only to those points and surfaces of the EUT which are accessible to the human operator during normal usage.
- Indirect application of the discharge: Discharges to objects placed or installed near the EUT shall be simulated by applying the discharges to a coupling plane (a horizontal coupling plane under the EUT or a vertical coupling plane).

IEC-1000-4 Application Notes

Test Results

The results of the ESD tests are reported as follows:

1. Normal performance within the specification limits.
2. Temporary degradation or loss of function or performance which is self-recoverable.
3. Temporary degradation or loss of function or performance which requires operator intervention or system reset.
4. Degradation or loss of function which is not recoverable, due to damage of equipment (component) or software, or loss of data.

IEC 1000-4-3

Radiated Electromagnetic Field Requirements

This test shows the susceptibility of instrumentation when subjected to electromagnetic fields such as those generated by portable radio transceivers or any other device that will generate continuous wave (CW) radiated electromagnetic energy.

Test Severity Levels

Frequency band : 27 MHz to 500 MHz

Level	Test field strength (v/m)
1	1
2	3
3	10
x	Special

“x” is an open class.

The test severity levels shall be selected in accordance with the electromagnetic radiation environment to which the EUT may be exposed when finally installed.

Test set-up

Examples of the test configuration for radiated electromagnetic fields can be found in Figure 4 and Figure 5.

- The procedure requires the generation of electromagnetic fields within which the test sample is placed and its operation observed. The tests shall be carried out in a shielded enclosure or anechoic chamber. The test procedure assumes the use of biconical and log-spiral antennae or stripline.
- All testing of the equipment shall be performed in conditions as close as possible to the actual installation.

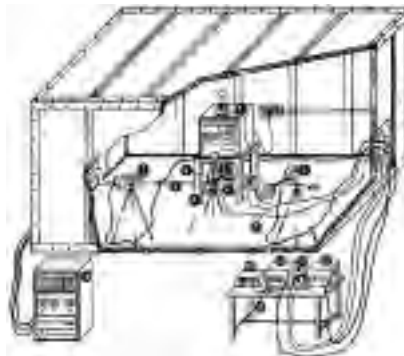

Figure 4. Test set-up for radiated electromagnetic field tests in a shielded room where the antennae, field strength monitors and EUT are inside and the measuring instruments and associated equipment are outside the shielded room.

Small objects (25cm x 25cm x 25cm) can be tested using a striplineantennae. This is a parallel plate transmission line to generate an electromagnetic field as shown in Figure 6.

Test Procedure

- The test is performed with the EUT in the most sensitive physical orientation.
- The frequency range is swept from 27 MHz to 500 MHz. The sweep rate is in the order of 1.5×10^{-3} decades/sec.

Test Results

The results of the radiated electromagnetic field include:

1. The effect of the electromagnetic field on the output of the EUT,
 - As a consistent measurable effect.
 - As a random effect, not repeatable, and possibly further classified as a transient effect occurring during the application of the electromagnetic field and as a permanent or semi-permanent field after the application of the electromagnetic field.
2. Any damage to the EUT resulting from the application of the electromagnetic field.

The qualitative evaluation of the resultant data needs to be assessed in terms of the existing local ambient electromagnetic level and the specific operating frequencies.

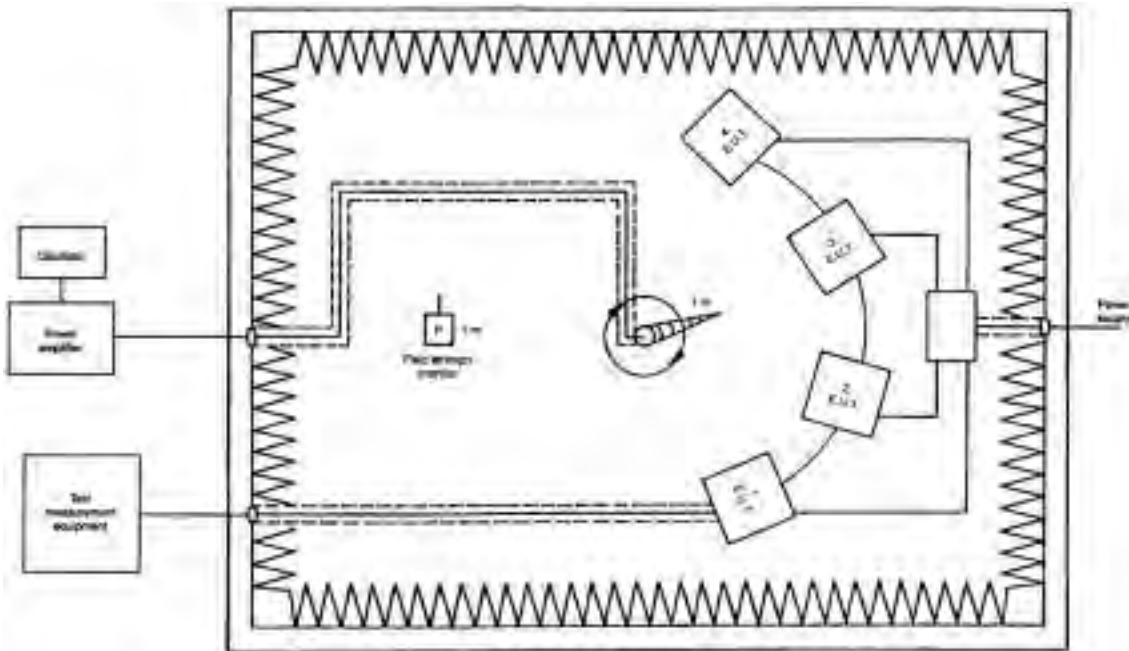

Figure 5. Test set-up for radiated electromagnetic field tests in an anechoic chamber, general arrangement of the EUT, field strength monitor and antennae.

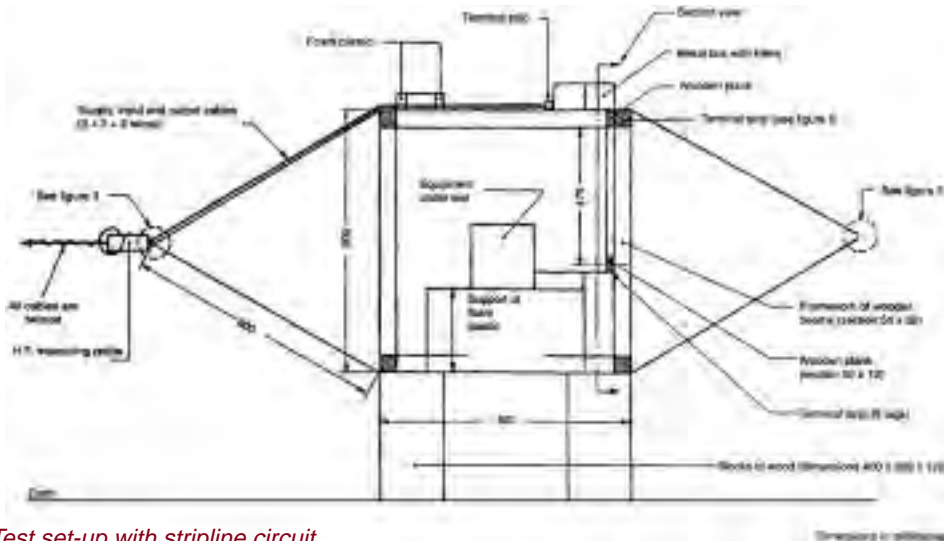

Figure 6. Test set-up with stripline circuit.

IEC-1000-4 Application Notes

IEC 1000-4-4

Electrical Fast Transient (Burst) Requirements

This test is intended to demonstrate the immunity of the equipment when subjected to interference originating from switching transients.

Test Severity Levels

Open circuit output test voltage: +/- 10%

Level	On power supply	On Input/Output signal data and control lines
1	0.5 kV	0.25kV
2	1kV	0.5kV
3	2kV	1kV
4	4kV	2kV
x	Special	Special

"x" is an open level.

The test severity levels should be selected in accordance with the most realistic installation and environmental conditions.

Characteristics of the Fast Transient/Burst Generator

- Risetime of one pulse: 5 nSec +/- 30 %
- Impulse duration (50% value): 50 nSec +/- 30%
- Repetition rate of the impulses and peak values of the output voltage:
 - 5 kHz +/- 20% at 0.125 kV
 - 5 kHz +/- 20% at 0.25 kV
 - 5 kHz +/- 20% at 0.5 kV
 - 5 kHz +/- 20% at 1.0 kV
 - 5 kHz +/- 20% at 2.0 kV
- Burst duration: 15 mSec +/- 20%
- Burst period: 300 mSec +/- 20%.

Test Set-up

For laboratory testing, the test set-up for type testing can be shown in Figure 7 and Figure 8.

- Power supply lines (See Figure 7): If the line current is higher than 100 A, the "field test" shall be used.
- Earth connections of the cabinets: The test point on the cabinet shall be the terminal for the protective earth conductor. (See Figure 7)
- Input/Output circuits and communication lines (See Figure 8).

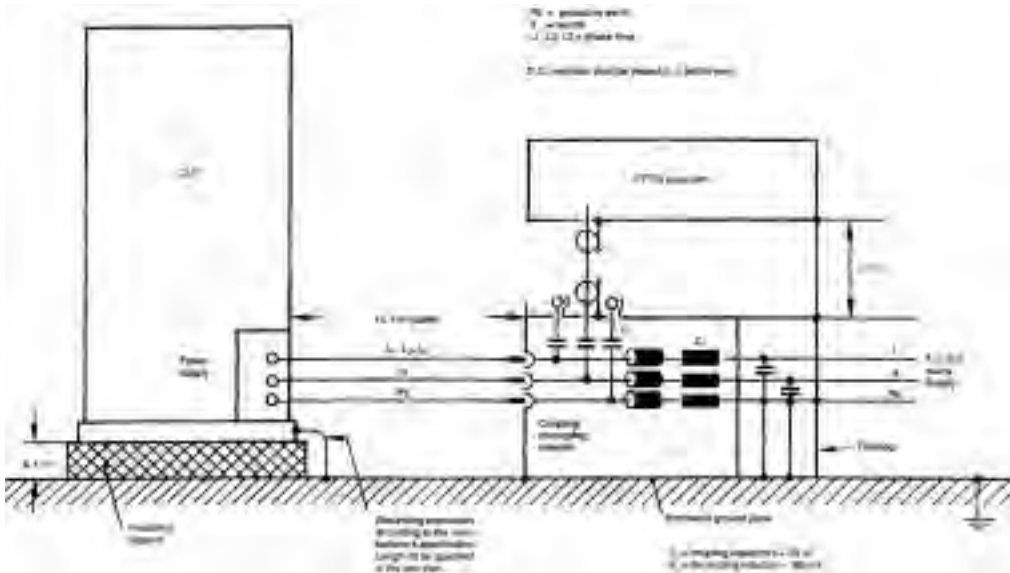

Figure 7. Example of test set-up for direct coupling of the test voltage to a.c./d.c. power supply lines/terminals for laboratory test purposes.

For field testing, the equipment or system shall be tested in the final installed conditions without coupling/decoupling networks.

- Power supply lines and protective earth terminals:
 - Stationary, floor-mounted EUT: The test voltage

shall be applied between a reference ground plane and each of the power supply terminals, AC or DC, and on the terminals for the protective or function earth on the cabinet of the EUT. (See Figure 9).

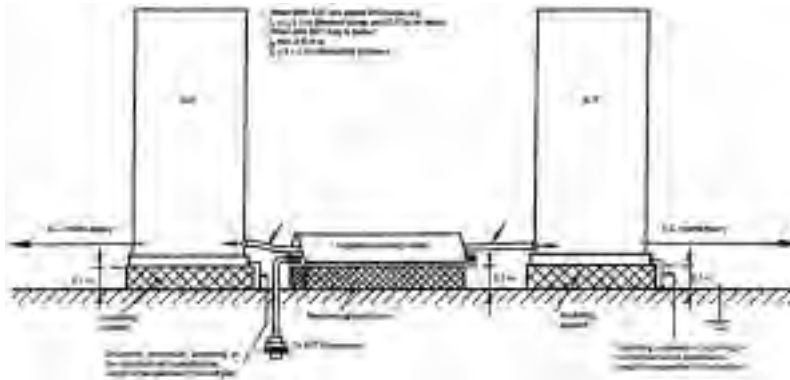

Figure 8. Example of test set-up for application of the test voltage by the capacitive coupling clamp for laboratory test purposes.

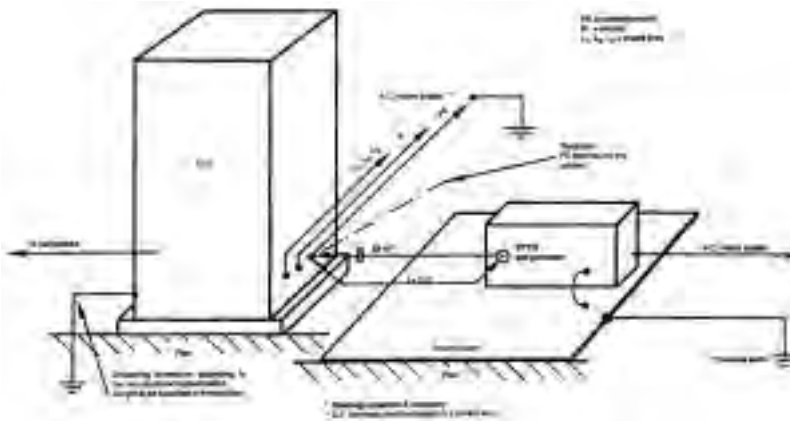

Figure 9. Example for field test on a.c./d.c. power supply lines and protective earth terminals for stationary, floor mounted EUT.

IEC-1000-4 Application Notes

– Non-stationary mounted EUT, connected to the mains supply by flexible cord and plugs: The test voltage shall be applied between each of the power supply conductors and the protective earth at the power supply outlet to which the EUT is to be connected. (See Figure 10).

- Input/Output circuits and communication lines:
 - A capacitive clamp shall be used for coupling the test voltage into the lines. However, if the clamp cannot be used due to mechanical problems in the cabling, it may be replaced by a tape or a conductive foil enveloping the lines under test. (See Figure 11).

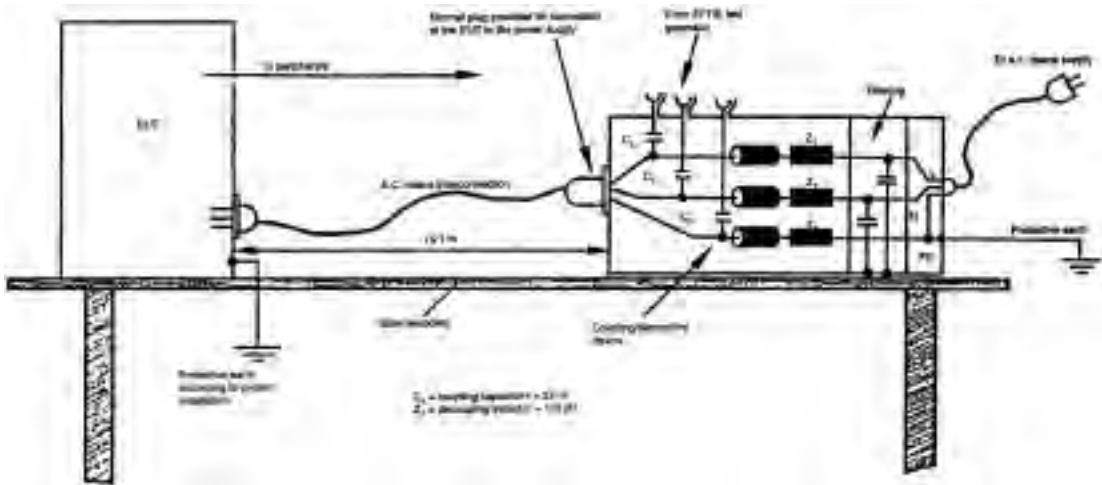

Figure 10. Example for field test on AC mains supply and protective earth terminals for non-stationary mounted EUT.

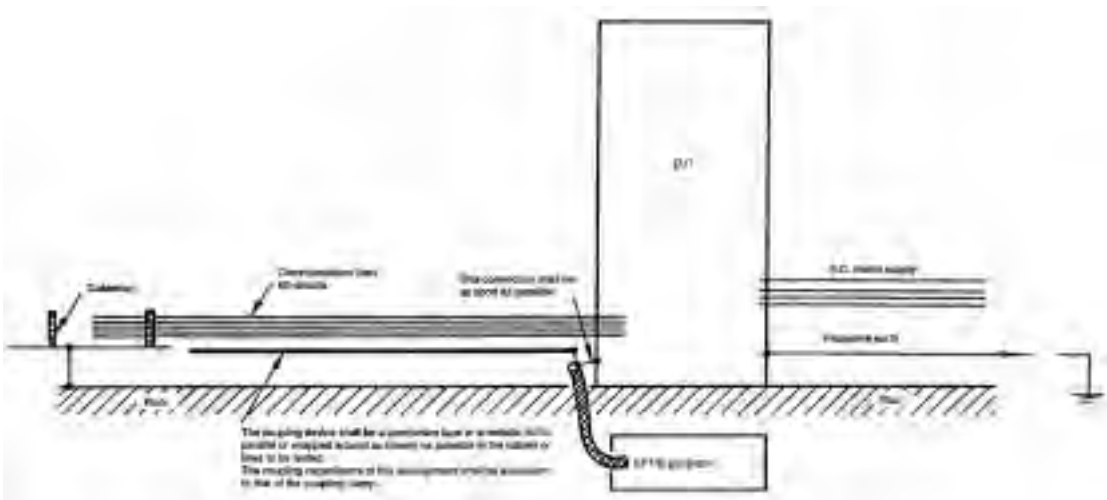

Figure 11. Example for field test on communications and I/O circuits without the capacitive coupling clamp.

IEC-1000-4 Application Notes

Test Procedure

- Polarity of the test voltage : both polarities are mandatory.
- Duration of the test : at least 1 min.

Test Results

The results are reported as:

1. Normal performance within the specification limits.
2. Temporary degradation or loss of function or performance which is self-recoverable.
3. Temporary degradation or loss of function or performance which requires operator intervention or system reset.
4. Degradation or loss of function which is not recoverable, due to damage of equipment (component) or software, or loss of data.

IEC 1000-4-5

Surge Voltage Immunity Requirements

The goal of the laboratory test is to determine the equipment’s susceptibility to damage caused by overvoltage surges caused by circuit switching and lightning strikes.

Test Severity Levels

Class	Power Supply		Unsym. Lines Long Data Bus		Symmetrical Lines	Data Bus (Short Dist)
	Line to Line Z = 2Ω	Line to Ground Z = 12Ω	Line to Line Z = 42Ω	Line to Ground Z = 42Ω	Line to Ground Z = 42Ω	Line to Ground
0			No test is advised			
1	-	0.5kV	-	0.5kV	1.0kV	-
2	0.5kV	1.0kV	0.5kV	1.0kV	1.0kV	0.5kV
3	1.0kV	2.0kV	1.0kV	2.0kV	2.0kV	-
4	2.0kV	4.0kV	2.0kV	4.0kV	-	-
5	*	*	2.0kV	4.0kV	4.0kV	-
x			Special			

Z is the source impedance.
 *Depends on the class of the local power supply system.
 “x” is an open level that has to be specified in the product specification.
 The class depends on the installation conditions.

Characteristics of the Test Instrumentation

- Combination wave test generator:
 Open circuit output voltage: from 0.5kV to 4.0kV
 Short circuit output current: from 0.25kA to 2.0kA

	in accordance with IEC60-2		in accordance with IEC469-1	
	Front time	Time to half value	Rise time (10%-90%)	Duration (50%-50%)
Open circuit voltage	1.2μs	50μs	1μs	50μs
Short circuit current	8μs	20μs	6.4μs	16μs

- Test generator 10/700 μs (according to CCITT):
 Open circuit output voltage: from 0.5kV to 4.0kV
 Short circuit output current: from 12.5A to 100A.

	in accordance with IEC60-2		in accordance with IEC469-1	
	Front time	Time to half value	Rise time (10%-90%)	Duration (50%-50%)
Open circuit voltage	10μs	700μs	6.5μs	700μs
Short circuit current	-	-	4μs	300μs

The surges (and test generators) related to the different classes are:
 Class 1 to 4: 1.2/50 μs (8/20 μs)
 Class 5: 1.2/50 μs (8/20 ms) and 10/700 μs

Test set-up

A decoupling network is used to prevent surge energy from being propagated to the other equipment operating from the same source during testing of the EUT. The test set-up for evaluating the EUT power supply is shown in Figures 12 - 15. A capacitive coupling network (preferred) or an inductive coupling network is used for this test.

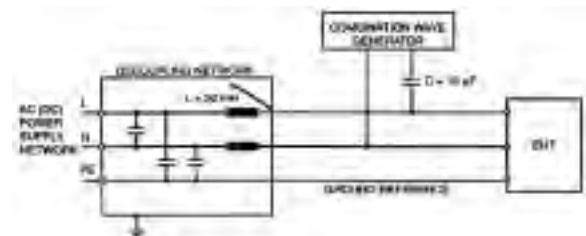

Figure 12. Test set-up for capacitive coupling on AC/DC lines; line to line coupling according to 7.2.

IEC-1000-4 Application Notes

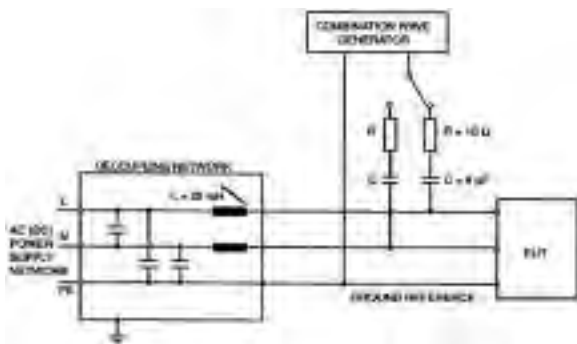

Figure 13. Test set-up for capacitive coupling on AC/DC lines; line to ground coupling according to 7.2 (generator output floating or earthed).

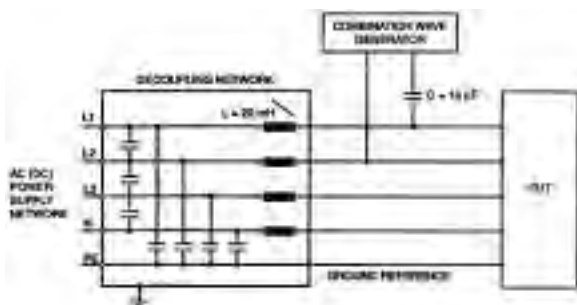

Figure 14. Test set-up for capacitive coupling on AC lines (3 phases); line to line coupling according to 7.2.

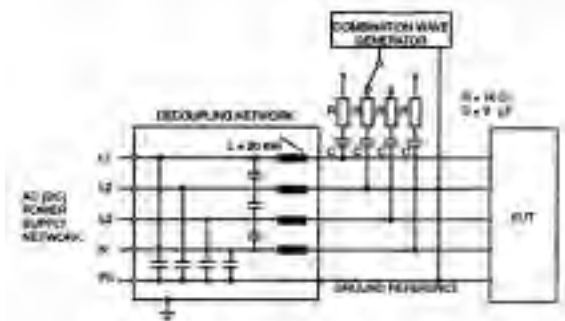

Figure 15. Test set-up for capacitive coupling on AC lines (3 phases); line to ground coupling according to 7.2.

The test set-up for evaluating the unshielded interconnection lines of the EUT is illustrated in Figures 16-20. Usually, capacitive coupling is used, but inductive coupling or coupling via gas discharge tube (GDT) surge arrestors is also possible.

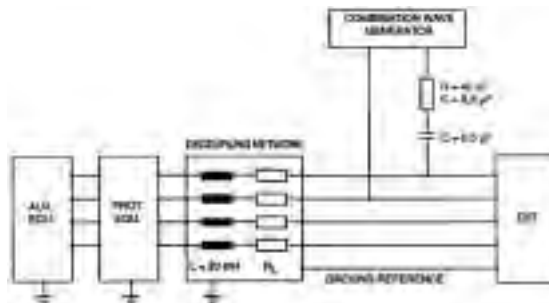

Figure 16. Test set-up for unshielded interconnection lines; line to line coupling according to 7.3; coupling via capacitors.

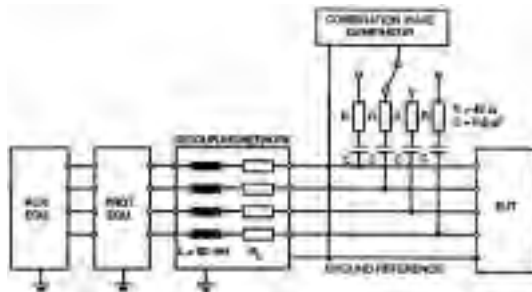

Figure 17. Test set-up for unshielded interconnection lines; line to ground coupling according to 7.3; coupling via capacitors.

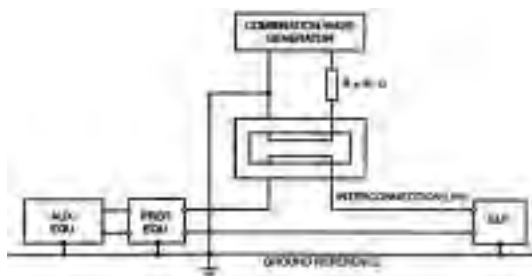

Figure 18. Test set-up for unshielded interconnection lines; line to line coupling according to 7.3; inductive coupling for high impedance circuits.

IEC-1000-4 Application Notes

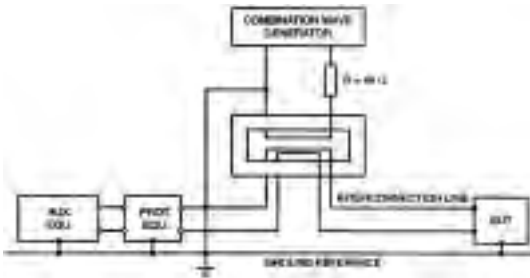

Figure 19. Simplified test set-up for unshielded interconnection lines; line to ground coupling according to 7.3; inductive coupling for low impedance circuits.

The test set-up for evaluating the unshielded symmetrically operated interconnection and telecommunication lines of the EUT is shown in Figure 21. The coupling is performed via a gas discharge tube (GDT) surge arrester.

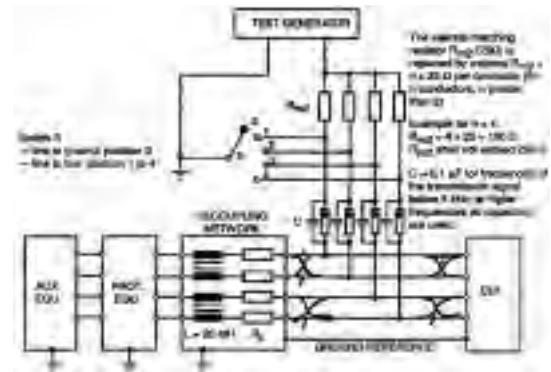

Figure 21. Test set-up for unshielded symmetrically operated lines (telecommunication lines); line to ground coupling according to 7.4; coupling via gas arresters.

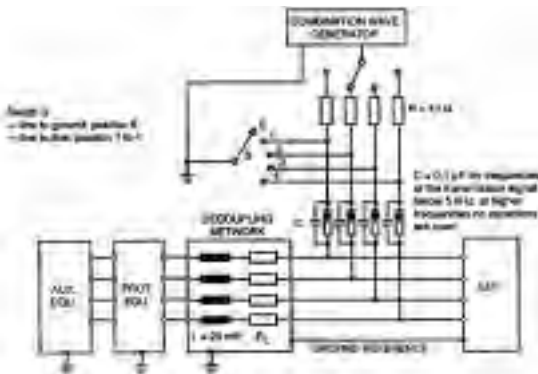

Figure 20. Test set-up for unshielded unsymmetrically operated lines; line to ground coupling according to 7.3; coupling via gas arresters.

Two test configurations should be considered:

- Equipment level immunity test: 0.5kV or 1kV.
The test shall be carried out in the laboratory on a single EUT. The voltage must not exceed the specified capability of the insulation to withstand high voltage stress.
- System level immunity test: 2kV or 4kV.
The EUT used in the equipment level testing above is integrated with the rest of the system equipment used to simulate the actual installation configuration. The simulated system installation includes protective devices and the real length and type of the interconnection lines.
This test is aimed at simulating as closely as possible the installation conditions. The test is also intended to show that secondary effects produced by the protective devices (change of waveshape, mode, amplitude of voltages, or currents) do not cause unacceptable effects on the equipment.

How to Test Spark Gaps

Often, commercial equipment is not available to test spark gaps (GDTs). This Application Note describes how to design and build instruments for performing several of the more common tests.

DC Breakdown Voltage

This is the voltage level at which the spark discharge occurs when the voltage across the gap is slowly increased. A linear ramp rate is usually specified and typically increases at a rate of 1000 volts per second or less. For most purposes, any adjustable voltage DC power supply (with adequate voltage output) can be used for DC breakdown voltage testing by slowly increasing the output voltage.

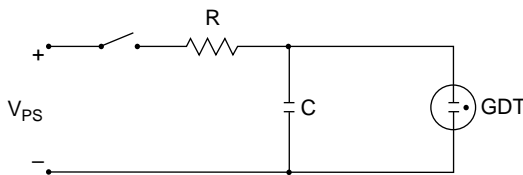

Figure 1. Simple DC breakdown voltage test circuit using an R-C circuit to set the ramp rate.

For more repeatability of the ramp rate, consider adding an R-C circuit to the output of the power supply as depicted in Figure 1. If the output voltage of the power supply is quickly increased to V_{PS} , then the voltage across the capacitor, $V_C(t)$, is given by:

$$V_C(t) = V_{PS}(1 - e^{-t/RC}) \quad (\text{eqn 1})$$

The instantaneous ramp rate is given by:

$$\frac{dv_C}{dt} = \frac{V_{PS}}{RC} e^{-t/RC} \quad (\text{eqn 2})$$

If equation 1 is solved for $e^{-t/RC}$ and substituted into equation 2, then:

$$\frac{dv_C}{dt} = \frac{V_{PS}}{RC} \left(1 - \frac{V_C(t)}{V_{PS}} \right) \quad (\text{eqn 3})$$

If the power supply voltage is set to 150% of the nominal breakdown voltage, then the quantity in parentheses in equation 3 is equal to 1/3 at breakdown. Substituting this into equation 3 yields:

$$\left. \frac{dv_C}{dt} \right|_{@BDV} = \frac{V_{PS}}{RC} \times \frac{1}{3} = \frac{V_{BDV}}{2RC} \quad (\text{eqn 4})$$

If the circuit uses a 0.01 μ F capacitor and a 25M Ω resistor (with the spark gap to be tested connected across the capacitor) and a 375V power supply to test a 250V spark gap, then the ramp rate will be 500V/s according to equation 4. Equation 3 can be used to check the ramp rate for breakdowns different from the nominal value. For a 212.5V (0.85 x 250V) breakdown, the ramp rate using the values given above would be 650V/s. For a 287.5V (1.15 x 250V) breakdown, the ramp rate using the values given above would be 350V/s.

For a more linear ramp, we suggest using a power supply with remotely controlled output voltage (which can function essentially like an operational amplifier) controlled with a low voltage linear ramp generator.

Impulse Breakdown Voltage

Building test equipment for impulse breakdown voltage testing is not as straightforward as for DC testing. One common approach is to use a pulse transformer (such as Clare's PT-5311). In its simplest form, the tester consists of a 0-500 volt DC power supply which charges a capacitor that is discharged through the primary of the pulse transformer. The gap under test is connected directly across the secondary of the pulse transformer. Coarse adjustment of the ramp rate can be accomplished by adding a capacitor (a few picofarad) across the gap under test. Fine adjustment can be accomplished by adjusting the output of the DC power supply.

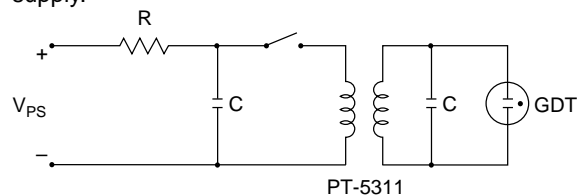

Figure 2. Simple circuit for generating impulse breakdown voltage waveforms.

How to Test Spark Gaps

Another common approach (especially for faster ramp rates) uses a high-energy spark gap (such as Clare's SB-4.0) as a switch to quickly discharge a capacitor with the test voltage existing across the discharge resistor as depicted in Figure 3. In this circuit, the ramp rate can vary greatly depending on the capacitor inductance and stray impedances.

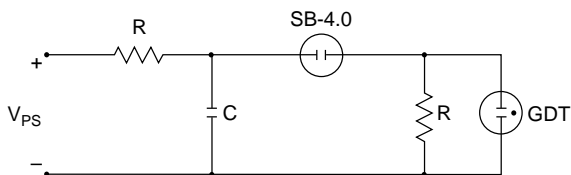

Figure 3. Simple circuit for generating faster impulse breakdown voltage waveforms.

Insulation Resistance

To make this measurement at the rated voltage (often 100V, but never exceeding the breakdown voltage of the gap) requires specialized equipment. A megohmmeter can be used to directly measure insulation resistance. A power supply and a sensitive ammeter can be used to measure the leakage current at the rated voltage. Dividing the leakage current into the voltage will yield the insulation resistance. For example, if a gap with 100V across it yields a leakage current of 10nA, then its insulation resistance is $10G\Omega$ ($100V/10nA$).

In situations where the insulation resistance limit is much lower (during life testing), insulation resistance measurements can often be reasonably made using a basic ohmmeter.

Use of Triggered Spark Gaps

Triggered spark gaps such as Clare’s TA and TB Series can be used for a variety of applications where low levels of control energy are used to rapidly switch high levels of stored energy. Typical applications include:

- Active switch in exploding bridgewire (EBW) systems
 - Ordnance firing
 - Rocket ignition
 - Oil field exploration
- Active switch in flash tube triggering
 - Provide high energy, high voltage trigger from low voltage, low energy control
- Active switch for capacitor bank discharging
- Electronic crowbar protection against current faults
 - Interelectrode arcs in magnetrons, TWTs, etc.
 - Power supply components

The triggered spark gap is an electrical component that permits high levels of stored energy to be switched in fractions of a microsecond. These high levels of stored energy can be switched on command by low energy control pulses. Triggered spark gaps require no standby power, are relatively small in size, and are extremely rugged for severe environmental requirements. Ambient temperature, humidity, and pressure variations do not affect the electrical characteristics. Triggered spark gaps are designed to operate after long periods of shelf life without need of electrode conditioning.

Modes of Operation

A triggered spark gap normally discharges energy through a pair of main electrodes¹; triggered by a pulse applied to the trigger electrode relative to the adjacent main electrode. The four modes of operation, A through D, denote the four possible combinations of trigger pulse polarity (+/-) and main discharge polarity (+/-) as defined in the table below:

Mode	Trigger Pulse Polarity (rel. to adj. main electrode)	Main Discharge Polarity (rel. to opp. main electrode)
A	+	+
B	-	-
C	+	-
D	-	+

The positive trigger pulse and main discharge polarities of Mode A are depicted in the figure below:

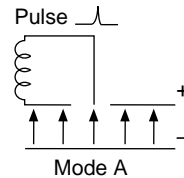

Figure 1. Illustration of positive trigger pulse and main discharge polarity conventions (Mode A).

Of the modes with a positive trigger pulse polarity (A and C), Mode A is the more commonly used – largely because the time delay is usually shorter and the minimum trigger voltage is usually lower in this mode.

However, Mode C is often chosen over Mode A for practical reasons. In Mode A, the direction of the gap field is the same as that of the trigger field. For relatively high adjacent main electrode voltages, the discharge of the trigger may take place at the opposite electrode which results in very efficient coupling of the charged products into the main gap. Mode A requires that the secondary of the pulse transformer be floating above ground or capacitively coupled. In Mode C, however, one side of the pulse transformer secondary can be tied to ground (along with the adjacent main electrode) for greatly simplified operation.

Of the modes with a negative trigger pulse (B and D), Mode B yields shorter time delays and smaller minimum trigger voltages.

Triggered Spark Gap Behavior in Circuits

As with two electrode spark gaps, the spark gap between the main electrodes of the triggered spark gap presents a near infinite impedance to the circuit when unfired. When voltage is applied across the main electrodes (less than the “self” breakdown voltage of the main electrodes), the circuit operation is unaffected by the presence of the triggered spark gap. When a sufficiently large trigger pulse is applied and the main discharge takes place, the tube drop (the voltage across the main electrodes) falls to values on the order of tens of volts for currents of up to several kiloamperes.

Use of Triggered Spark Gaps

The source energy that is available for discharge in the gap circuit will be dissipated totally in the triggered spark gap unless series resistance is included. By the inclusion of series resistance, the use of lower energy triggered spark gaps may be extended to higher energy circuits. For example, a typical tube drop might be 30V for a peak current of 3kA with a resultant effective main gap impedance of 0.01Ω. Therefore, if a 1Ω resistor is installed in series with the main gap, the triggered spark gap would only dissipate about 1% of the available energy (if the peak current is unchanged).

The trigger voltage required to cause main gap breakdown decreases as the applied voltage increases. A typical relationship between the minimum trigger voltage required for reliable main gap breakdown and the voltage applied across the main gap is shown in Figure 2:

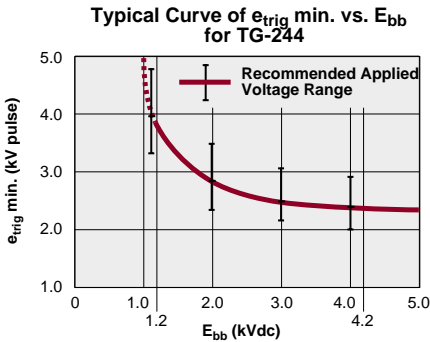

Figure 2. Minimum trigger voltage versus applied voltage for reliable operation for a TA-5.0.

A typical electronic crowbar application is depicted in Figure 3A.

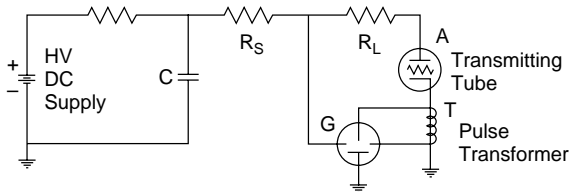

Figure 3A. Typical electronic crowbar application.

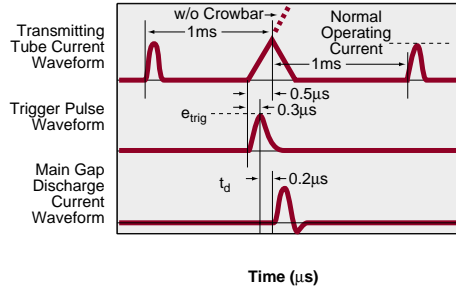

Figure 3B. (B) Various waveforms of crowbar operation.

A grid-to-plate arc in the high vacuum transmitting tube, A, creates a fast-rising current arc. When this occurs, the capacitor, C, can supply enough current to totally destroy the tube unless the plate supply is crowbarred in a sufficiently short period of time. The initial rise of the current surge through the primary of the pulse transformer, T, creates a pulse across the secondary of the pulse transformer that triggers the triggered spark gap, G. {Though depicted in Mode A or D (depending on the trigger pulse polarity), a ground-referenced pulse transformer could be used in Mode B or C by connecting the plate supply to the *opposite* main electrode and ground to the *adjacent* main electrode.}

The fault current waveform, the trigger pulse waveform, and the main gap discharge current waveform are shown in Figure 3B. Crowbaring of the plate supply is accomplished in a total time of 0.5μs. The time delay of the triggered spark gap is shown as 0.2μs and a delay in the pulse transformer is shown as 0.3μs. The magnitude and duration of the fault current have been sufficiently limited within the transmitting tube to be harmless and the energy stored in the capacitor has been dissipated in the triggered spark gap and the source resistance, R_s , instead of the transmitting tube.

Notes:

- 1 Triggered spark gaps consist of three electrodes including the trigger electrode and two main gap electrodes. The Adjacent Main Electrode is the main gap electrode adjacent to the trigger electrode. The Opposite Main Electrode is the main gap electrode opposite from the trigger electrode.

Use of Microwave Noise Sources

INTRODUCTION

Noise sources are the element in a microwave RF system that make it possible to accurately measure the noise figure of the receiver or its components. The requirements of a device used for making such noise figure measurements include broad bandwidth inherent in the active element, stability, ease of operation, and long life. When the gas discharge tube is mounted and terminated normally, it presents a “white signal” of constant intensity over a bandwidth limited only by the system or mount. In general, the range of usefulness of these noise sources permits measurements of noise figures from about 2 to 30 dB. Existing mountings provide a useful frequency range of approximately 100MHz to 220GHz.

The noise tube and/or noise source should meet the following general requirements:

- When not operating, it should present a low insertion loss and VSWR to the system.
- When operating, it should provide an adequate signal level.
- Its output should be frequency independent, or at least known, over the prescribed bandwidth.
- Its output should exhibit minimum spurious oscillations.

DEFINITIONS AND BASIC DISCUSSION

Noise Source Tube or Noise Tube — An electron tube filled with a rare gas (generally argon, neon, or a mixture) and operated in a positive column discharge mode at currents normally from 35 to 250 mA.

Noise Source or Noise Generator — A noise tube mounted in an appropriate waveguide or coaxial mount.

Noise Power — The available noise power from a noise source tube is essentially $kT_e B$ power coupled to the waveguide from the positive column of the discharge, where k is Boltzmann’s constant, T_e is the effective electron temperature of the discharge, and B is the bandwidth. To some extent, T_e can be estimated by the method of von Engel and Steenbeck.¹

In microwave power measurements, consideration is given to the noise temperature, T_n , which when multiplied by k gives the power per unit bandwidth of a noise source. T_n is determined by comparison of the noise source against a thermal load.² Appropriate

corrections must be made if the noise of the tube only is desired. Though T_n is often considered equal to T_e , such an approximation has been shown to have limited usefulness and the noise temperature of an individual noise tube or complete noise source should be measured rather than calculated for accurate results.³

Excess Noise Ratio {ENR or (Nr-1)} — The most important characteristic in microwave measurements, the excess noise ratio, is the ratio of the difference between the operating and non-operating temperatures to the non-operating temperature (the latter of which is assumed to be 290K). (Nr-1) is this ratio expressed in dB as

$$(Nr - 1) = 10 \times \log_{10} \left[\frac{T_n - 290K}{290K} \right]$$

At common pressures and operating currents, (Nr-1) for an argon noise tube is approximately 15.5 dB and for neon is approximately 18.0 dB. The exact value for any noise source is influenced by the tube radius and pressure and, to some degree, by current.⁴ The available noise from any given tube-mount combination depends as much on the characteristic of the mount and the method of coupling the tube into the mount as on any tube parameter.

Noise Figure {F} and Y-Factor {Y} — The noise figure of any network is defined as the ratio of signal to noise at the input to the signal to noise at the output^{5,6} as

$$F = \frac{S_i/N_i}{S_o/N_o}$$

For calculation purposes, the input signal generated by the gas discharge noise source can be rewritten as $S_i = [S_i + N_i] - N_i$. The total input when the noise source is ON is $[S_i + N_i] = kT_n B$ as defined for noise power. When the noise source is turned OFF, the input is thermal noise of $N_i = kT_o B$ where T_o is the operational temperature (290K). Therefore, $S_i = k[T_n - T_o]B$.

Again, for calculation purposes, the signal output of the device can be rewritten as $S_o = [S_o + N_o] - N_o$. In this case, $P_{ON} = [S_o + N_o]/B$ is the noise tube ON condition and $P_{OFF} = N_o/B$ is the noise tube OFF condition. Therefore, $S_o = [P_{ON} - P_{OFF}]xB$ and $N_o = P_{OFF}xB$.

Use of Microwave Noise Sources

Substituting into the noise figure equation above yields

$$F = \frac{k[T_n - T_o]B / kT_oB}{P_{ON} - P_{OFF} / P_{OFF}} = \left[\frac{T_n - 290K}{290K} \right] \left[\frac{P_{OFF}}{P_{ON} - P_{OFF}} \right]$$

The Y-factor is defined as $Y = P_{ON} / P_{OFF}$. The quantity in the second pair of brackets of the noise figure equation above can be expressed in terms of Y as

$$\frac{P_{OFF}}{P_{ON} - P_{OFF}} = \frac{1}{P_{ON} / P_{OFF} - 1} = \frac{1}{Y - 1}$$

Substituting this relation into the noise figure equation yields

$$F = \left[\frac{T_n - 290K}{290K} \right] \left[\frac{1}{Y - 1} \right]$$

or, expressed in dB,

$$F = 10 \times \log_{10} \left[\frac{T_n - 290K}{290K} \right] - 10 \times \log_{10} [Y - 1]$$

$$F = (Nr - 1) - 10 \times \log_{10} [Y - 1]$$

The last equation states that the noise figure of the system in dB is simply the excess noise ratio of the noise source, in dB, minus the value of (Y-1), in dB, as determined from a (Y) to (Y-1) logarithmic conversion. We now have the noise figure of the receiver defined in terms of all known quantities.

TYPES OF OPERATION

DC operation of filamentary cathode noise tubes — The DC supply in Figure 1 is fed to the tube through an inductance, L, and current limiting resistances, R₁ and R₂. Upon closing the starting switch, SW, current flows through the inductance, resistance R₂, and the filamentary cathode. When the switch is opened, the collapse of the magnetic field in L provides a high voltage spike that ionizes the gas in the tube and establishes the discharge from anode to cathode. The anode current is then limited by R₁. SW must be capable of fast break

operation and withstanding the high peak voltage developed. The DC supply must be capable of supplying the rated current at voltages greater than the tube drop.

The alternate configuration in Figure 2 uses a DC supply with a potential greater than the starting voltage to eliminate the need for the inductor and switch of Figure 1.

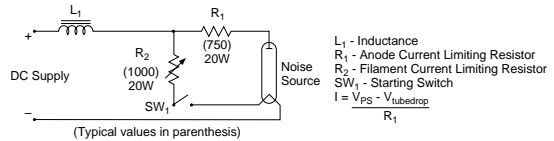

Figure 1. Circuit for DC operation of filamentary cathode tubes.

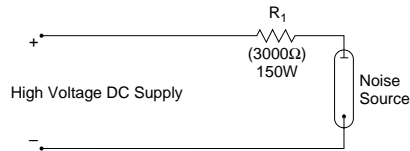

Figure 2. Typical circuit for high voltage DC operation of noise tubes.

Pulse operation of hollow cathode noise tubes — These tubes are capable of operating for hundreds of millions of starts. Primary parameters are pulse width, pulse current, and pulse repetition rate. The circuit in Figure 3 uses a high voltage transistor Q driven into saturation. The diode is added to help ensure discharge turn-off.

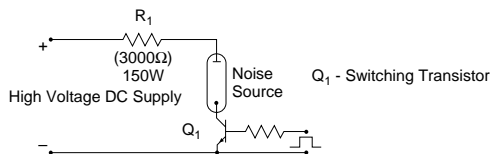

Figure 3. Simple circuit for pulse operation of noise tubes.

Use of Microwave Noise Sources

The circuit in Figure 4 adds current regulation via feedback through a second transistor, Q_2 .⁷ The resistor R_1 reduces the power that the high voltage transistor Q_1 , driven here in active mode, dissipates but it must be sufficiently small in value to avoid saturating Q_1 .

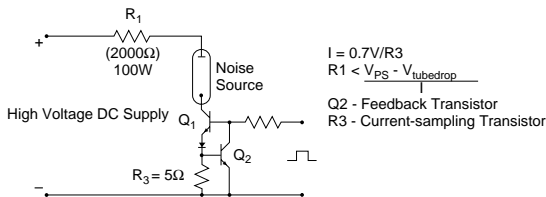

Figure 4. Circuit for pulse operation of noise tubes with current regulation.

DC or pulse operation of indirectly-heated cathode noise tubes — These tubes may be operated by the circuit in Figure 1 modified to include a continuous filament voltage (often 6.3VAC). The circuits in Figures 2 through 4 may be used without modification.

Grounded anode operation — For all previous methods of operation and cathode types, the polarity can be reversed when desirable so the anode may be operated grounded. In the circuit in Figure 1, under reversed polarity conditions, the inductor L would be moved to the cathode side as would the limiting resistor R_1 . Similar modifications would be made to the circuits in Figures 2 through 4 with the NPN transistors replaced with PNP transistors.

The advantage of operating with a grounded anode is that the anode potential is distributed along the length of the tube by the metal tube holder of the mount which results in a 10-50% decrease in the starting voltage depending upon the particular tube type and mounting arrangement.

AC operation of noise tubes with dual filamentary cathodes — When operation directly from an AC source is desired and AC modulation of the noise is not objectionable, the circuit of Figure 5 is suitable. Transformer T must provide sufficient voltage to strike the discharge. L may be included in the transformer as leakage reactance but should be of a size to limit the average tube current to the specified value. SW can be

eliminated if the secondary voltage of T is made high enough to provide a cold start without filament preheat.

Operation of a single-ended tube in this circuit will result in excessive anode heating with probable failure of the anode seal.

OPERATIONAL PARAMETERS

DC operation of filamentary cathode noise tubes — In the circuits of Figures 1 and 2, these tubes generally require 700-2500V starting spikes, operate at anode currents of 50-250mA DC, and exhibit tube drops on the order of 40-150VDC. Their life under conditions of essentially continuous operation, with only occasional starts, is generally in excess of 8000 hours and may be as high as 20,000 hours. Their life under pulse conditions is short. The circuits in Figures 3 and 4 can also be used for DC operation.

Pulse operation of hollow cathode noise tubes — In the circuits of Figures 3 and 4, these tubes usually require starting spikes of 700-3000V, operate at peak currents from 75-175mA, and have tube drops of 100-250V. Under pulse conditions with duty cycles of up to 50%, their life is typically 2000-5000 hours. In general, under intermittent DC conditions, they have adequate life of at least 500-1000 hours.

DC or pulse operation of indirectly-heated cathode noise tubes — In the circuits of Figures 1 through 4, these tubes can be operated with very long life under either DC or pulse conditions. This particular cathode assembly utilizes an electrostatic shield around the cathode resulting in minimum ion bombardment of the active cathode surface area. The coated area is such that the maximum current density for any tube of this type is ultra-conservative. These tubes generally require starting pulses on the order of 500-2000V,

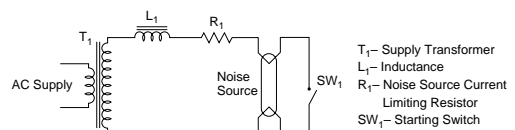

Figure 5. Circuit for AC operation of noise tubes with dual filamentary cathodes.

Use of Microwave Noise Sources

operate typically from 35-200mA DC or 50-150mA peak pulse, and have tube drops from 40-200V. Under intermittent DC conditions, life is generally in excess of 10,000 hours and may be as high as 50,000 hours. Under pulse conditions, at duty cycles up to 50%, their life is typically 3000-7000 hours.

Grounded anode operation — As mentioned previously, grounded anode operation reduces all starting voltage requirements.

AC operation of noise tubes with dual filamentary cathodes — In the circuit of Figure 5 driven by 60-400Hz sine waves, these tubes generally require starting voltages on the order of 1000-2500VAC, operate at currents of 100-250mA AC, and exhibit tube drops on the order of 40-150VAC. Typical life under 60Hz conditions is 100-1000 hours, depending on the circuit parameters.

IONIZATION TIME

Because of the presence of the rare gas, there is a finite time required for the discharge to become stable in any gas discharge noise tube. In argon-filled tubes, the discharge will normally become stable in 50-150ms after the completion of the starting spike. For neon, these times are on the order of 80-300ms.

These times may be modified drastically by the drive circuit, however. If there is appreciable ringing in the circuit, or if the supply voltage is only slightly greater than the tube operating voltage at the rated current, the time for a tube to establish a stable discharge may be much longer. In general, by proper circuit design, these indicated times can be attained for any of the types of operation mentioned above.

The ionization time is an important factor in making pulsed noise figure measurements (discussed later in this note).

DEIONIZATION TIME

Again because of the presence of the rare gases, these tubes have finite deionization times. In argon at 200mA current and 20 Torr pressure, the deionization times are on the order of 70-300ms, depending on tube diameter. In neon at the same current and pressure, deionization

times are normally 150-500ms. These deionization times can be improved by the application of a slight negative voltage when the tube is being turned off, in a pulse application for example. Deionization times generally increase with current.

MICROWAVE CHARACTERISTICS

General considerations — The level of the ENR that can be attained from any noise source is determined by the available ENR from the noise tube itself and by the coupling of the noise tube in the mount. The available ENR from the noise tube is determined principally by the type of fill gas, the gas pressure, and, to some small extent, by the tube current. The coupling in the mount is determined by the insertion angle of the tube through the mount, by the type of gas fill, and by the ratio of the tube diameter to the maximum guide dimension.⁸ The coupling is also affected by the gas pressure and the tube current. The mounting is so important that the success with which any combination of noise tube, mount, and termination meets the general requirements at the end of the Introduction section of this note depends as much on the mounting method as on any other single feature.

Mounting methods — The most common methods and their relative advantages and disadvantages include:

- 0° to 30° E-plane insertion
Advantages include extremely broad bandwidth (within the tolerances of the ENR specified for tube-and-mount, this style of mounting yields a frequency independent noise source), very low VSWR, very low non-operating insertion loss, and high operating insertion loss (therefore, very little reduction in the available ENR⁹ from the noise source itself). Disadvantages include relatively large size, high voltage starting spike, and relatively high tube drop.
- 90° E-plane insertion, transmission-type
Advantages include fair VSWR, very small size, low voltage starting spike, low tube drop, and low non-operating insertion loss. Disadvantages include low operating insertion loss (therefore, appreciable reduction in the available ENR), and relatively narrow bandwidth (~10-20%).
- 90° E-plane insertion, shorted-type
Advantages include small size, low voltage starting

Use of Microwave Noise Sources

spike, low tube drop, and high operating insertion loss (therefore, negligible reduction in the available ENR). Disadvantages include poor VSWR and very narrow bandwidth (~5-10%).

- 90° H-plane insertion, transmission-type
Advantages include low non-operating insertion loss, fairly small size, good non-operating VSWR, and moderate voltage starting spike and tube drop. Disadvantages include poor operating VSWR, low operating insertion loss (with a resultant reduction in the available ENR), and very narrow bandwidth.
- Coaxial, helix-coupled
Advantages include permitting the use of noise tubes originally designed for waveguide bands down into the UHF region, relatively broad bandwidth, good operating insertion loss, relatively good operating VSWR, and fair non-operating insertion loss and VSWR in the prescribed bands. Disadvantages include relatively large size, high voltage starting spike, and relatively high tube drop.
- Coaxial, direct-coupled

The advantages and disadvantages of this type are the same as for the helix coupling except that the direct coupling approach, with the toroidal cross section tube family used in this approach, presents much lower non-operating insertion loss than the helix coupling approach. Since these types are almost all transmission types used directly in front of the receiver, the low non-operating insertion loss yields two advantages. First, there is less attenuation of the incoming signal during system operation and, secondly, there is no correction necessary to the available ENR as a result of significant non-operating loss.¹⁰

Comparative noise measurements — Comparative noise measurements are made by Clare in a test system shown schematically in Figure 6. Since these measurements depend ultimately on the stability of the gain set (which can be checked by visual observation of the output meter over a period of time long compared with the measurement time), the tolerances to which Clare ENR specifications are written are at least five times greater than the system capability.

System noise figure measurements — Noise figure has been summarized completely by Mumford and

Scheibe¹¹ and reviewed in the Definitions and Basic Discussion section earlier in this note. Our discussion here will be concerned only with precautions to be taken with pulsed noise sources in making noise figure measurements.

The voltage and current curves of Figure 7 show typical pulsed tube performance as a function of time. The voltage across the tube rises to a very high value, at which point the tube breaks down. The voltage then falls to almost zero and, eventually, stabilizes at the tube drop after several tens of microseconds. The current usually stabilizes faster than the tube drop.

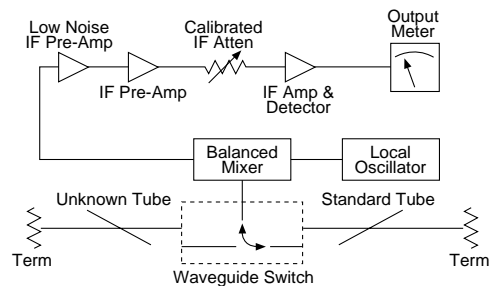

Figure 6. Schematic diagram of set-up for measuring ENR.

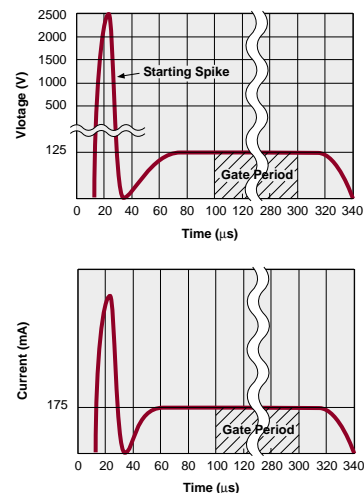

Figure 7. Typical voltage and current waveforms for TD-72 pulse type noise tube (argon filled).

Use of Microwave Noise Sources

If the “on” time of the receiver gating period starts too soon, there will be a fraction of the total gate period during which the noise power will not have the rated noise output of the tube at the given current because the tube drop, and consequently the field in the positive column, will not have been stabilized. Whenever possible, therefore, the total gating period should be long, ideally a few hundred microseconds, and the initiation of the gating period should be delayed as long as possible following the high voltage starting spike.

Another consideration is that the gating period during which the receiver looks at the cold, non-operating, noise source should be as long as possible after the main transmitter pulse (for a unit being used in the transmitter arm through a directional coupler) so that the lapsed time definitely is long compared with the deionization time of the tube.

Finally, use of a noise source for which there is the smallest possible difference between the operating and non-operating match is important when the noise source is the element being viewed as the cold reference for the system.

Variations with tube current — Since a change in current causes a slight change in tube drop, and thereby a slight change in the field in the positive column, there is a small correction to the ENR of a tube as a result of an actual change in the effective electron temperature. Further, there is an additional small change to the available ENR from the tube-in-mount as a result of the changing insertion loss caused by the change in current.

■ **Noise vs. current**

For most noise tubes, there is a decrease in ENR with current of 0.003-0.005 dB/mA.

■ **Tube drop vs. current**

For most noise tubes, the tube drop tends to decrease about 0.13-0.26 V/mA.

■ **Insertion loss vs. current**

Nominal values of operating and non-operating insertion loss for argon noise tubes in specific waveguide mounts are given in Table 1. Also, the tube-to-tube variations of operating insertion loss for typical operating insertion loss values of <20dB, 20-30dB, and >30dB are ±0.2-0.6dB, ±0.4-1.0dB, and ±1-3dB, respectively.

TABLE 1. Cold and Hot Insertion Loss for Argon Noise Sources

Band	Types (TD-)	Mount & Meas't Freq (GHz)	Typical Insertion Loss (dB)					
			I = 0	125	150	175	200	250mA DC
S	12,38	WR-284, 10°E; 3.3	0.12	12.3	13.5	14.0	14.5	15.1
C	10,39	WR-187, 10°E; 5.5	0.11	14.8	16.9	17.3	18.8	20.8
J	10,39	WR-137, 10°E; 7.0	0.16	20.4	22.8	23.8	25.4	28.1
X	40	WR-90, 10°E; 9.0	0.18	18.2	20.8	22.8	24.4	26.0
X	11,72	WR-90, 10°E; 9.0	0.06	23.2	25.7	27.6	29.5	32.2
Ku	18,41	WR-62, 10°E; 16.0	0.07	32.0	37.9	44.1	51.0	54.5
K	13,42	WR-42, 10°E; 24.0	0.10	25.8	31.7	37.8	44.0	57.5

Use of Microwave Noise Sources

APPLICATIONS AND GENERAL OPERATING NOTES

Determination of the noise figure — This is the basic use of noise sources; for either a single component or an entire system. This determination stems from the relation: $(F) = (Nr-1) - (Y-1)$, where (F) is the system noise figure, (Nr-1) is the ENR of the noise generator, and (Y) is the output meter reading; all quantities in parentheses being in dB and $Y = 10^{(Y)/10}$. See the Definitions and Basic Discussion for more detail.

Noise sources are the basic component of noise figure test sets. They are also used as built-in receiver monitors in radar systems directly in the receiver and/or antenna arms as depicted in Figure 8.

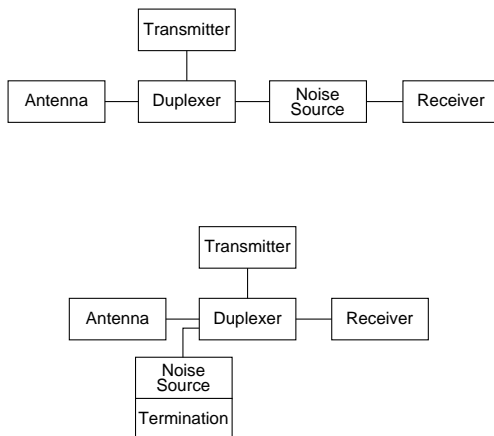

Figure 8. Block diagrams of noise sources in (A) the receiver arm and (B) the antenna arm of a radar system.

Polarity — Since all noise sources are polarized devices, except those specifically designed for AC operation, they should never be operated in reverse. Under conditions of reverse operation, the life will be extremely short with failure due to anode seal breakage as the result of excessive heating.

Ambient temperatures — All rare gas filled noise tubes can be operated over a temperature range of -55°C to $+125^{\circ}\text{C}$. Some noise sources cannot be operated over this entire range because built-in shorting plates or terminations may present temperature-dependent characteristics.

Life — The life of a noise tube depends principally upon the type of cathode, the mode of operation (CW or pulse), and the gas pressure. Under CW conditions, the indirectly heated cathodes exhibit extremely long life because their surface area is such that the current density is ultra-conservative. Similarly, the filamentary cathodes are conservatively rated with respect to current density.

Under pulse conditions, again the indirectly-heated cathodes have very long life for two reasons. The first is the lower starting spike required in a tube with this style cathode and the resulting drastically reduced ion bombardment of the cathode during the starting spike. The second is the conservative design with respect to the current density. The hollow cathodes exhibit good life under pulse conditions because the design of these cathodes causes the cathode coating which is sputtered during the starting spike to be re-deposited on another part of the cathode between pulses. Filamentary cathodes typically last only a few hundred thousand discharges of normal starting spikes. In a typical pulsed noise figure setup operating at a rate of 500 pps, one hundred thousand pulses are achieved in less than one hour. Therefore, this type cathode definitely is not recommended for pulse operation.

The principal mode of failure of gas discharge noise tubes is loss of cathode coating with its consequent increase in tube drop and starting voltage. The second failure mode is gas pressure reduction with its consequent change in tube drop and ENR.

Fortunately, the changes in tube drop and starting voltage occur long before there is any significant change in gas pressure. If the starting voltage increases by 20% or if the tube drop increases by 10%, end-of-life may be considered as having been reached. Within this period of time, negligible change in the ENR will have taken place.

Use of Microwave Noise Sources

For noise tubes with filamentary or indirectly-heated cathodes—For argon-filled noise tubes with indirectly-heated cathodes, the life is in excess of 10,000 hours and may be as long as 50,000 hours when operated DC. The life drops to 3000-7000 hours when pulse operated.

For argon-filled noise tubes with filamentary cathodes, the life is in excess of 8000 hours and may be as long as 20,000 hours when operated DC.

Neon-filled noise tubes with either type of cathode have roughly half the life of similarly constructed and operated argon-filled noise tubes.

For pulse-operated noise tubes with hollow cathodes—For argon-filled noise tubes, the life is typically 2000-5000 hours. For neon-filled noise tubes, the life is typically 1000-2000 hours.

For AC tubes with dual filamentary cathodes—Though usually rated for 100 hours of operation under 60-400Hz conditions, the life is typically on the order of 500-1000 hours with as little as 0.05-0.10dB change in the ENR.

Notes:

¹ A. Von Engel and M. Steenbeck, *Elektrische Gasentladungen*, Springer, Berlin, vol. 2, p. 86; 1939.

² J. S. Wells, et al, "Measurement of effective temperature of microwave noise sources", *IEE Trans on Instr and Meas*, vol. IM-13, No. 1, pp. 17-28; Mar 1964.

³ K. W. Olsen, "Measured noise temperature vs theoretical noise temperature for gas discharge noise sources", *IEEE Trans Micro Th and Tech*, Vol. MTT-16, No. 9; Sept 1968.

⁴ *Ibid.*

⁵ C. K. S. Miller, C. W. Daywit, and M. G. Arthur, "Noise standards, measurements, and receiver noise definitions", *Proc IEEE*, Vol. 55, No. 6, pp. 865-877; Jun 1967.

⁶ W. W. Mumford and E. H. Scheibe, Noise Performance Factors in Communications Systems, Chapters VI-VIII, Horizon House, Dedham, Mass.; 1968.

⁷ R. B. Bartlow, et al, "Increased analytical precision in the hollow cathode discharge source by improved discharge current control", *Anal Chem*, Sept 1991.

⁸ H. Johnson and K. R. deRemer, "Gaseous discharge super high frequency noise sources", *Proc IRE*, vol. 39, pp. 908-917; Aug 1951.

⁹ W. D. White and J. G. Greene, "On the effective noise temperature of gas discharge noise generators", *IRE Corres*, pp. 939, Mar 1956.

¹⁰ *Ibid.*

¹¹ Mumford and Scheibe, *loc. cit.*

AC Current

This specification is the maximum RMS current that a device can conduct for a specified number of AC line cycles without causing permanent degradation.

Actuation Time

The time interval from coil energization or de-energization to the functioning of a specified contact; same as contact actuation time. Subdivided as follows:

Final Actuation Time

The sum of the initial actuation time and the contact bounce intervals following such actuation.

Initial Actuation Time

The time from coil energization or de-energization to the first closing of a previously open contact or the first opening of a previously closed contact. See also operate time and release time.

Air Gap

An unsealed spark gap. Often parallel-connected as a secondary protector (with a higher breakdown voltage than the primary gas tube device) as a secondary means of protection in the event of venting to atmosphere by the primary gas tube device.

Ampere Turns

The number of turns of an electromagnetic coil winding times the current (measured in amperes) passes through the winding.

AT or NI

Arc Voltage

The voltage drop across a gas tube surge arrester conducting in the arc mode. Typical values range from 7 to 20 volts. See V-I Characteristic.

V_{ARC}

Break

The opening of closed contacts to interrupt an electric circuit.

Breakdown Voltage

The voltage at which a crowbar-type surge arrester changes from a high impedance state to a low impedance state. Breakdown voltage may vary with the rate of rise of the applied voltage. This term is meaningful only if dv/dt is specified.

Breakover Current

The principal current at the breakover point.

I_{BO}

Breakover Voltage

The principal voltage at the breakover point. For surge arresters, peak voltage across the device in, or at, the breakdown region measured under specified rate-of-rise voltage (dv/dt) and current.

V_{BO}

Carry Current

The amount of current that can safely be passed through closed switch contacts.

Clamp

A surge protector that limits the voltage of a transient by varying its internal resistance in response to the applied voltage. Clamp-type protectors dissipate the bulk of the transient energy internally. MOVs and avalanche diodes are clamp-type protectors.

Clamping Voltage

The voltage drop across a clamp-type protector while it is conducting. The term is meaningful only if the current through the clamping device is specified.

Coil

An assembly of multiple turns of wire. When current is applied to the coil, a magnetic field is generated, which can be used to close a mechanical or reed switch.

Collector/Emitter Voltage

Voltage measured at the collector terminal of a transistor with respect to the emitter terminal.

V_{CE}

Common Mode

A voltage level as measured between one or more lines and ground (common) or a current flowing between one or more lines and ground (ground). A common-mode surge between neutral and ground in an AC system is the most damaging type of surge for most equipment. It should be noted that this definition of common-mode, as generally used in surge protection literature, differs slightly from the definition used in other electrical disciplines. For example: the IEEE Standard Dictionary of Electrical and Electronic Terms defines a common-mode signal as the instantaneous algebraic average of two signals applied to a balanced circuit, both signals referred to a common reference; FCC Part 68 refers to 1/2 of the vector sum of two signals, an equivalent concept. An explanation of these differences is that the IEEE and FCC definitions are more useful in analyzing overall circuit performance whereas the surge protection definition is more useful in analyzing the behavior and protection requirements of individual conductors. Also referred to as longitudinal mode.

Common Mode Range

The maximum voltage that can appear on the inputs with respect to ground.

Common Mode Rejection Ratio

CMRR

The isolation amplifier's ability to reject identical signals applied to the isolator inputs from appearing at the isolator's outputs. The ratio is expressed in dB.

Contact Bounce

The intermittent opening and closing of contacts occurring during contact transition from one state to another due to mechanical reaction.

Contact Rating

The electrical load—handling capability of relay contacts under specified conditions for a prescribed number of operations.

Contact Resistance

The electrical resistance of closed contacts; measured at their associated contact terminals after stable contact closure.

Continuity Transfer

A contact combination in which one contact closes its connection to another and then opens its prior connection to a third contact. Form D contact.

Continuous Load Current

I_L

Maximum current value that flows continuously across the output terminals of the OPTOMos relay under designated ambient temperature conditions. Represents the peak value for AC current.

Control Voltage

V_{OP}

The input voltage range during which the output of the device will operate.

Critical Rate of Rise

di/dt

The maximum value of the rate-of-on-state current which a surge arrester can withstand without deleterious effect.

Crowbar

A surge protector that limits the energy delivered to the protected circuit by abruptly changing from a high impedance state to a low impedance state in response to an elevated voltage level. A crowbar is usually connected so as to shunt the energy of the transient to ground. Very little energy is dissipated internally by a crowbar-type device. The bulk of the energy from a transient is dissipated by the external wiring and resistive elements. Gas tubes and SCRs are crowbar-type protectors.

Current-Sensing Relay

A relay that functions at a predetermined value of current; an overcurrent or an undercurrent relay, or a combination of both.

Current Transfer Ratio

CTR

With regard to a photocoupler, this is the measure of phototransistor collector current that can be expected for a given LED forward current. It is usually expressed in %. 100% CTR means there is a 1:1 relationship

between LED current (I_{LED}) and the collector current (I_C). The relationship is expressed as $CTR = (I_C/I_{LED}) \times 100\%$.

DC Breakdown Voltage V_{BD}

The voltage at which a crowbar-type surge protector changes from a high impedance state to a low impedance state when subjected to a slowly increasing DC voltage (typically increasing at a rate of 1000 volts per second or less).

DC Current Gain β

With regard to a bipolar transistor, it is expressed as the ratio I_C/I_B where I_C is the collector current and I_B is the base current. For a transistor to be used as an amplifier, $\beta \gg 1$.

Dark Current I_D

The phototransistor leakage current with the LED in the off-state. The dark current is proportional to collector voltage.

Double Throw DT

A contact combination having two positions as in break-make, make-break, etc.

Dielectric Strength V_{ISO}

The maximum allowable voltage that can be applied between two specified test points such as input-output, input-case, and between current-carrying and non-current carrying points.

Double Pole DP

A contact arrangement that includes two separate contact combinations; two single-pole contact assemblies.

Dry Circuit

A contact that carries current but neither opens nor closes while its load circuit is energized. Does not refer to low-level contacts.

Dynamic Breakdown Voltage

See Impulse Breakdown Voltage.

Dynamic Contact Resistance

A change in contact electrical resistance caused by a variation in contact pressure on mechanically closed contacts (see Fig. 1.01 and 1.02); occurs during non-bounce condition.

Electrostatic Shield

Copper alloy material terminated to one pin and located between two or more mutually insulated elements within relay; minimizes electrostatic coupling between coil and reed switch.

Electromagnetic Pulse (EMP)

A high energy field containing both electrical and magnetic components. This term usually refers to the field generated as a result of an atomic explosion. Severe electrical transients, characterized by extremely fast rise times, will be coupled into electrical conductors that are exposed to an EMP.

Energization

The application of power to a relay's coil winding. With respect to an operating coil winding, use of the word commonly assumes enough power to operate the relay fully unless otherwise stated.

Fail-Safe

A back-up mechanism often added to three-electrode gas tube surge arresters. The fail-safe shorts the line electrodes to ground if a Power Cross condition exists with sufficient current to cause excessive device heating and damage to other components.

Follow-On Current

This term is generally used only in reference to the protection of AC power lines. It is the current that flows through a crowbar-type surge protector after the trailing edge of a transient. Follow-on current must be limited to a specified value to ensure that the surge protector returns to a high impedance state at the next zero crossing of the AC waveform.

Form-A

SPST NO or Single Pole Single Throw Normally Open.

Form-B

SPST NC or Single Pole Single Throw Normally Closed.

Form-C

SPDT or Single Pole Double Throw. Normally closed contact breaks before normally open contact makes.

Form-D

SPDT or Single Pole Double Throw. Normally open contact makes before normally closed contact breaks — continuity transfer.

Forward Gain $K2$

The ratio of the output photocurrent to the LED forward current.

Frequency Response $BW (-3dB)$

The frequency at which the output signal decreases -3dB from the input signal.

Gas Tube Surge Arrester

A device intended to limit voltage that contains two or more electrodes in a gas-filled hermetically-sealed chamber. Gas tube surge arresters are crowbar-type devices that are characterized by high surge current ratings and low capacitance. They are used extensively as primary and secondary protectors for telecommunications and AC power lines.

Glow Mode

The conductive mode of a gas tube that exists when the circuit impedance limits the current to a value less than the glow-to-arc transition current. See V-I Characteristic.

Glow Voltage

The voltage drop across a gas tube while it is in the glow mode. The glow voltage is between the arc voltage and the breakdown voltage of the device. Typical values are 60 to 150 volts, dependent on fill gas and electrode material and geometry. See V-I Characteristic.

Hermetically Sealed Relay

A relay contained within an enclosure sealed by fusion or other comparable means to ensure a low rate of gas leakage. (Generally, metal-to-metal or metal-to-glass sealing is used.)

Holding Current I_H

The minimum principal current required to maintain the surge arrester in the on-state.

Holdover Voltage

The maximum DC voltage across the terminals of a gas tube surge arrester under which it may be expected to extinguish and return to a high impedance state after the passage of a surge, under specified circuit conditions.

I/O Capacitance $C_{I/O}$

Capacitance between the input and output terminals.

I/O Isolation Voltage $V_{I/O}$

Critical value before dielectric breakdown occurs, when a high voltage is applied for 1 minute across the same terminals where the I/O isolation resistance was measured.

Impulse

A unipolar transient or test waveform. An impulse is normally specified both in terms of the Open Circuit Voltage (OCV) and Short Circuit Current (SCI). Unless otherwise specified, the waveform is a double exponential with rise and decay times expressed in microseconds. Example: 3kV, 1.2/50ms describes a waveform having a peak open circuit voltage of 3000 volts, a rise time to peak voltage of 1.2ms, and a decay time to 1500 volts of 50ms.

Impulse Breakdown Voltage V_{bd}

The voltage at which a crowbar-type surge protector changes from a high impedance state to a low impedance state when subjected to an impulse (typically increasing at a rate of 100 volts per microsecond or greater). The term is meaningless unless the dv/dt is specified.

Impulse Ratio

The ratio of the impulse breakdown voltage of a device to the DC breakdown voltage of a device (never less than unity).

Input Offset Voltage

Voltage that must be applied between the input terminals through two equal resistances to obtain zero output voltage.

Input to Output Leakage Current

The current that flows from the input common across the isolation barrier to the output common when 240V_{RMS} at 60 Hz is applied across input and output commons.

Input and Output Stage Supply Current

Current required from the power supply to operate the amplifier with no load and the output midway between the supplies.

Input Voltage Drop

Dropout voltage across the input terminals due to forward current.

Insulation Resistance

The minimum allowable DC resistance between all isolated pins.

Insulation Resistance

The effective DC impedance, expressed in ohms, of a gas tube while in the high impedance state. Insulation resistance must be measured at a lower voltage than the DC breakdown voltage of the device and is typically measured at 100 VDC for devices having a DC breakdown voltage of 145 volts or higher and at 50 VDC for devices having a DC breakdown voltage below 145 volts.

Interelectrode Capacitance

The capacitance of a surge protector. Typically less than ten picofarads for gas tube surge arresters.

LED Forward Current

Current that flows across the input terminals when the input diode is forward biased.

LED Turn Off Current

Current when the output switches off (by decreasing the LED current) after operating the relay with a designated supply voltage and load connected across the output terminals.

Latching Relay

A relay that maintains its contacts in the last assumed position without needing to maintain coil energization.

Load Power Factor

The phase angle (cos θ) between load voltage and load current in an electrical circuit caused by the reactive component of the load (Z / R).

Load Voltage

Supply voltage range at the output used to normally operate the OptoMOS relay. Represents the peak value for AC current.

Magnetic Interaction

If relays are mounted in close proximity, the flux produced when the coils are energized affects the pickup and dropout values. This either increases or decreases both pickup and dropout values. The direction of the parameter shift is determined by the whether the stray flux aids or bucks the flux produced by the coil of the relay under consideration. Problems may result from bucking flux raising the pickup voltage close to the coil drive voltage or by aiding the flux of sufficient magnitude that the relay will not drop out when its drive is removed. To calculate the change in pull-in voltage and dropout voltage, multiply the percent change shown by the relay's nominal voltage. For example, if the percent change in pull-in voltage is 14% for a 5V nominal relay, the pull-in voltage will increase by 0.7 volts.

Magnetic shield

A ferromagnetic material used to reduce magnetic coupling.

Nuclear Electromagnetic Pulse (NEMP)

EMP.

Normal Mode

A voltage level as measured between two lines or a current flowing between two lines. Also referred to as line-to-line, transverse mode, or metallic mode.

Normally Closed

A contact combination that is closed when the armature is in its unoperated position. Form B contact.

Normally Open

A contact combination that is open when the armature is in its unoperated position. Form A contact.

Off State Collector/Emitter Leakage

The current I_C that flows from the collector to the emitter with the transistor in the cut-off or off state.

Off-State Leakage Current

(Maximum off-state current). In relays, the current that flows through the load when the relay is in the off state. The parameter is an effective current and is specified at maximum-load voltage.

Off-State Capacitance

The capacitance in the offstate measured at specified frequency, amplitude and DC bias.

On Resistance

Obtained using the equation below from dropout voltage V_{DS} (on) across the output terminals (when a designated LED current is made to flow through the input terminals and the designated load current through the output terminals.) R_{ON} = V_{DS(on)} / I_L

Operate Time

The time interval from coil energization to the functioning of the last contact to function. Where not otherwise stated, the functioning time of the contact in question is taken as its initial actuation time (does not include contact bounce time).

Operate Value

The value at which all relay contacts must restore to their unoperated positions as the current or voltage on an operated relay decreases.

Operating Frequency

The pulse rate of the output signal to be switched.

Operating Temperature

Ambient temperature range in which the OptoMOS relay can operate normally with a designated load current condition.

Output Capacitance

Capacitance between output terminals when LED current does not flow.

Output Offset Voltage

The Voltage which appears at the output of the isolation amplifier with the input grounded.

Peak Blocking Voltage

Maximum voltage at which the device will not exceed the maximum value of the off-state leakage current.

Peak Forward Current

Maximum instantaneous value of the forward current.

Phototransistor Blocking Voltage

Maximum V_{CE} at which the device will not exceed the maximum value of the off-state leakage current.

Power Cross

A telecommunications term referring to the fault condition that occurs when a live AC power line comes in contact with a telephone line. Surge protectors that are intended for telecommunications use are usually rated as to the magnitude and duration of AC power that they can withstand without permanent damage. See AC Current and Fail-Safe.

Power Dissipation - Input

Allowable power dissipation across the input terminals.

Power Dissipation - Output

P_{OUT}
Allowable power dissipation across the output terminals.

Power Supply Rejection Ratio

PSRR
Ratio of the change in input offset voltage to the change in power supply voltages producing it.

Q

The decay rate of a ringing wave. The term indicates the number of cycles that are required to produce an half-cycle peak value less than 5% of the peak value of the initial half cycle.

Radioactive Stabilization

A radioactive isotope added to some gas tube surge protectors inducing a constant level of residual ionization. This background ionization reduces the statistical lag of the avalanche buildup, thus reducing the voltage variations from one breakdown to the next for an individual device and reducing the differences between breakdown in light and darkness. Comgaps with radioactivity use a beta emitter so that no radiation is detectable outside the sealed device.

Reed Relay

A glass-enclosed, magnetically operated contact using thin, flexible magnetic conducting strips as the contact members.

Reference Zener Voltage

V_Z
The voltage the surge arrester decreases to and holds constant after reaching the breakover voltage.

Release Time

The time interval from coil de-energization to the functioning of the last contact to function. Where not otherwise stated, the functioning time of the contact in question is taken as its initial actuation time (does not include contact bounce time).

Release Value

The value at or below which all contacts must function as the current on an unoperated relay increases.

Response Time

The time interval between the instant when the surge arrester breaks down and the establishment of the arc voltage.

Reverse Input Voltage

V_R
Reverse breakdown voltage across the input terminals.

Reverse Leakage Current

I_{LEAK}
Current that flows when a device is reversed biased under the influence of an electrical field.

Ring Wave

A damped oscillatory, usually cosinusoidal, with a steep specified rise. Ring waves are characterized by three terms: rise time, frequency, and Q. They are frequently used to simulate the effects of some types of transients.

Rise Time

For voltage waveforms: 1.67x the time between the points at which the waveform passes through 30% and 90% of the peak value. For current waveforms: 1.25x the time between the points at which the waveform passes through 10% and 90% of the peak value. The purpose of these calculations is to establish the timing characteristics of the corresponding virtual wavefront, an idealized linear ramp. Perfectly linear ramps are not achievable in the real world due to the finite impedances of the ramp generating components.

Saturation Voltage

V_{CESAT}
With the transistor in the on-state, this is the VCE voltage. It is normally around 0.2V for a bipolar transistor.

Servo Gain

K1
The ratio of the servo photocurrent to the LED forward current.

Settling Time

The time between the initiation of the input step function and the time when the output has settled to within a specified error band of the final output voltage.

Single Pole

SP
A term applied to a contact arrangement in which all contacts connect (in one position or another) to a common contact.

Slew Rate

S/R
The rate of change in output voltage with a large amplitude step function applied to the input. Measured in V/time (usually v/s)

Small Signal Bandwidth

The frequency range from DC to a frequency where the amplifier gain rolls off -3dB.

Storage Temperature

T_{STG}
Ambient temperature range in which the OptoMOS relay can be stored without applying voltage.

Surge

A transient wave of voltage, current, or power. It may be either unidirectional or oscillatory.

Surge Current

The current that flows as a result of a transient discharging into a low impedance load. Surge current is generally a double exponential waveform with rise and decay times expressed in microseconds. Example: 500A, 10/1000ms describes a waveform having a peak short circuit current of 500 amperes, a rise time to peak current of 10ms, and a decay time to 250 amperes of 1000ms. This term is meaningless unless the timing characteristics of the waveform are specified.

Surge Life

The maximum number of specified current surge pulses which a surge protector can withstand without causing permanent degradation of its electrical parameters. The term is meaningless unless the failure criteria and repetition rate are specified.

Temperature Coefficient

$\Delta K3/\Delta T$
The transfer gain (K3) deviation with temperature, expressed in %/°C.

Total Harmonic Distortion

THD
The measure of non-linearity expressed in dB. It can be expressed as $20 \text{ Log} [(f_1+f_2+...f_n)^{1/2}/f_0]$, where f_0 is the fundamental frequency amplitude and f_n is the nth harmonic measured.

Total Power Dissipation

P_{TOT}
Allowable power dissipation in the entire circuit between the input and output terminals.

Transfer Gain

K3
The ratio of K2 to K1 ($K3=K2 / K1$).

Transient

Surge.

TVS Diode (Transient Voltage Suppression Diode)

An avalanche diode that has been fabricated with a relatively large junction area. TVS diodes are designed to provide somewhat higher surge current ratings than standard avalanche diodes (zeners). They are characterized in terms of the peak wattage that can be dissipated.

Turn-Off Time

T_{OFF}
Delay time until the output switches off after the input has been driven.

Turn-On Time

T_{ON}
Delay time until the output switches on after the input has been driven.

Zero-Cross Turn-On Voltage

V_{ZCTON}
Voltage above which the device will not operate until the next zero-crossing.

Part Number	Page	Part Number	Page
1.0 x 0.1 Series	451	CUP Series	464
1.0 x 0.15 Series	451	CUP 1 Series	464
922A Series	451	CUPC001A1xx	464
922AxxC1C	451	CUPC001B1xx	464
922AxxC2C	451	CUPC001L1xx	464
922AxxC3C	451	CUPC002A1xx	464
922AxxC4C	451	CUPC002B1xx	464
AC120	528	CUPC003A1xx	464
ATE Series	459	CUPC004A1xx	464
ATE11Axx10	459	CUPC005A1xx	464
ATE21Axx20	459	CUPC1A1B1xx	464
ATE31Cxxxx	459	CUPC2A2B1xx	464
ATE41Axxxx	459	CUPE001A1xx	464
ATE61Axxxx	459	CUPE001B1xx	464
ATE71Axxxx	459	CUPE001L1xx	464
CG110	530	CUPE002A1xx	464
CG110SN	533	CUPE002B1xx	464
CG2-1000	530	CUPE003A1xx	464
CG2-145	530	CUPE004A1xx	464
CG2-145SN	533	CUPE005A1xx	464
CG2-230	530	CUPE1A1B1xx	464
CG2-230SN	533	CUPE2A2B1xx	464
CG2-250	530	CUPP001A1xx	464
CG2-250SN	533	CUPP001B1xx	464
CG2-300	530	CUPP001L1xx	464
CG2-300SN	533	CUPP002A1xx	464
CG2-350	530	CUPP003A1xx	464
CG2-350SN	533	CUPP004A1xx	464
CG2-470	530	CUPP005A1xx	464
CG2-470SN	533	CUPP02B1xx	464
CG2-600	530	CUPP1A1B1xx	464
CG2-800	530	CUPP2A2B1xx	464
CG3-1.0	536	CUPV1000x	464
CG3-1.5	536	CUPV1010x	464
CG3-2.0	536	CUPV1020x	464
CG3-2.5	536	CUPV1030x	464
CG3-3.0	536	CUPV1040x	464
CG3-3.5	536	CYG2000	361
CG3-4.0	536	CYG2001	361
CG3-5.0	536	CYG2010	361
CG3-7.5	536	CYG2011	361
CG3-8.5	536	CYG2017	361
CG5-230	539	CYG2020	361
CG5-350	539	CYG2021	361
CG5-90	539	CYG2030	361
CG75	530	CYG2031	361
CG820	541	CYG2100	366
CG90	530	CYG2110	366
CG90SN	533	CYG2120	366

INDEX BY PART NUMBER

Part Number	Page	Part Number	Page
CYG2217	370	LAA127L	195
CYG2911	374	LBA110	201
DIP 14 Series	476	LBA110L	201
DIP 16 Series	483	LBA120	215
DIP Series	471	LBA120L	215
DIP10001	471	LBA126	224
DIP10002	471	LBA127	230
DIP10015	471	LBA127L	230
DIP10025	471	LBB110	239
DIP10050	471	LBB120	247
DIP10100	471	LBB126	251
DIP31Cxxx	471	LBB127	255
DIP41Axxxx	471	LCA100	92
DIP61Axxxx	471	LCA100L	92
Dry Reed Switches	516	LCA110	98
DSS41Axxx	498	LCA110L	98
DSS41Bxxx	498	LCA120	108
DSS71Axxx	476	LCA120L	108
DYAD®	516	LCA125	114
Electromechanical Relays	512	LCA125L	114
EMIT101	60	LCA126	120
EMIT600	62	LCA127	124
EMIT1200	64	LCA127L	124
EMIT2001	66	LCA710	130
EMIT2020	68	LCB110	134
EMIT3020	70	LCB120	138
ESMIT100	82	LCB126	142
ESMIT300	84	LCB127	146
EMR Series	512	LCC110	259
FDA215	394	LCC120	264
FR2xxxxx-xxxx	516	LDA100	378
IAA110P	325	LDA101	378
IAA170P	338	LDA110	378
IAB110P	325	LDA111	378
IAD110P	325	LDA200	381
IAD112N	325	LDA201	381
IAD170P	338	LDA210	381
IBB110P	325	LDA211	381
ITC117P	317	LIA100	356
ITC135P	317	LIA101	356
ITC137P	317	LM44xxx	512
LAA110	169	LOC110	350
LAA110L	169	LOC111	350
LAA120	179	LOC112	350
LAA120L	179	LOC210	353
LAA125	185	LOC211	353
LAA125L	185	LQ52xxxx	512
LAA126	191	LSR2Cxxx	483
LAA127	195	LX200xxx	512

Part Number	Page	Part Number	Page
Mini-DYAD™	516	MRF41A05xx	494
MIT101	32	MRF81A05xx	494
MIT101V	34	OAA160	269
MIT115	36	OMA160	150
MIT115V	38	PAA110	273
MIT125	40	PAA110L	273
MIT131	42	PAA140	279
MIT139	44	PD1201	385
MIT179	46	PD2401	385
MIT205	48	PD2601	385
MIT262	50	PLA110	154
MIT372	52	PLA110L	154
MIT538	54	PLA140	160
MIT600	56	PLA160	164
MIT3262	58	PLCA110	345
MLR Series	486	PM1204	391
MLR 10001	486	PM1205	391
MLR 10002	486	PM1206	391
MLR 10003	486	PMT(275)350	549
MLR 10004	486	PMT(275)400	549
MLR 10005	486	PMT(275)450	549
MLR31Cxxxx	486	PMT(275)500	549
MLR41Axxxx	486	PMT(301)1.0	552
MLR61Axxxx	486	PMT(301)1.5	552
MN1xxxx-xxxx	516	PMT(301)2.0	552
MRB Series	451	PMT(301)2.5	552
MRB1Axxxx	451	PMT(301)3.0	552
MRB1Bxxxx	451	PMT(301)3.5	552
MRB1Lxxxx	451	PMT(301)350	552
MRB1Nxxxx	451	PMT(301)400	552
MRB2Axxxx	451	PMT(301)500	552
MRB2Bxxxx	451	PMT(301)550	552
MRB2Lxxxx	451	PMT(301)600	552
MRB2Nxxxx	451	PMT(301)800	552
MRB3Axxxx	451	PMT3(310)-150	543
MRB4Axxxx	451	PMT3(310)-230	543
MRB5Axxxx	451	PMT3(310)-250	543
MRB6Axxxx	451	PMT3(310)-350	543
MRBS Series	491	PMT3(310)-400	543
MRBS001Axxx	491	PMT3(310)-500	543
MRBS20001	491	PMT8-90	546
MRBS20002	491	PMT8-230	546
MRBS20003	491	PMT8-350	546
MRBS20010	491	PRMA10037	476
MRBS20012	491	PRMA10038	476
MRBS20031	491	PRMA10039	476
MRBS20043	491	PRMA1Axxx	476
MRBS20046	491	PRMA1Bxxx	476
MRF Series	494	PRMA1Cxxx	476

INDEX BY PART NUMBER

Part Number	Page	Part Number	Page
PRMA2Axxx	476	TFT Series	507
PRME1500x	476	TFT31Cxxxx	507
PRME2500x	476	TFT41Axxxx	507
PS1201	388	TFT61Axxxx	507
PS2401	388	TFT71Axxxx	507
PS2601	388	TFT91Axxxx	507
Reed Switches	515	TG Legacy Series	564
SB-1.0	555	TG Series	564
SB-1.5	555	TN Series	571
SB-2.0	555	TS112	284
SB-3.0	555	TS117	288
SB-4.0	555	TS117L	288
SB-400	555	TS118	298
SB-5.0	555	TS120	302
SB-600	555	TS122	306
SB-800	555	TS190	310
SG-10.0	555	TS190L	310
SG-15.0	555	UBD-1.0	561
SG-2.0	555	UBD-1.2	561
SG-20.0	555	UBD-1.5	561
SG-25.0	555	UBD-2.0	561
SG-30.0	555	UBD-2.5	561
SG-35.0	555	UBD-3.0	561
SG-40.0	555	UBD-4.0	561
SG-5.0	555	UBD-550	561
SIL41Axxx	498	UBD-600	561
SIL41Bxxx	498	UBD-650	561
SIP Series	498	UBD-750	561
SMIT204	72	UBD-850	561
SMIT2412	80	UBT-10.0	561
SMIT304	74	UBT-12.0	561
SMIT314	76	UBT-15.0	561
SMIT2393	78	UBT-20.0	561
SMR Series	504	UBT-4.0	561
SMR41A05xx	504	UBT-5.0	561
SMR61A05xx	504	UBT-6.0	561
TA-1.0	558	UBT-7.5	561
TA-10.0	558	UGT-10.0	561
TA-15.0	558	UGT-12.0	561
TA-2.0	558	UGT-15.0	561
TA-5.0	558	UGT-20.0	561
TA-7.0	558	UGT-4.0	561
TB-10.0	558	UGT-5.0	561
TB-15.0	558	UGT-6.0	561
TB-2.5	558	UGT-7.5	561
TB-20.0	558	UMT(275)1.0	549
TB-25.0	558	UMT(275)1.5	549
TB-5.0	558	UMT(275)2.0	549
TD Series	571	UMT(275)2.5	549

Part Number	Page	Part Number	Page
UMT(275)550	549		
UMT(275)600	549		
UMT(275)650	549		
UMT(275)750	549		
UMT(275)800	549		
UMT(275)850	549		
XAA170	175		
XBA170	210		
XBB170	243		
XCA170	104		
XS170	294		



Copyright ©1998 CP Clare Corporation, 78 Cherry Hill Drive, Beverly, Massachusetts 01915, USA. All rights reserved. The copyright in this document is owned by CP Clare Corporation. Any person is hereby authorized to view, copy, print and distribute this document subject to the following conditions:

- The document may be used for informational purposes only.
- The document may only be used for non-commercial purposes.
- Any copy of this document or portion thereof must include this copyright notice.

TRADEMARKS:

CP CLARE, DYAD, POWERDIP, OPTOMOS, DATALINK are registered trademarks of CP Clare Corporation and Mini-DYAD, CYBERGATE are trademarks of CP Clare Corporation.

Any product, process or technology in this document may be the subject of other intellectual property rights reserved by CP Clare Corporation or its subsidiaries, and may not be licensed hereunder.

All other product names, trademarks, registered trademarks, service marks or registered service marks, mentioned throughout any part of this publication belong to their respective owners.

DISCLAIMERS:

THIS PUBLICATION IS PROVIDED "AS IS" WITHOUT WARRANTY OF ANY KIND, EITHER EXPRESS OR IMPLIED, INCLUDING, BUT NOT LIMITED TO, THE IMPLIED WARRANTIES OF MERCHANTABILITY, FITNESS FOR A PARTICULAR PURPOSE, NON-INFRINGEMENT OR ARISING FROM A COURSE OF DEALING, USAGE TRADE OR PRACTICE.

THIS PUBLICATION COULD CONTAIN TECHNICAL INACCURACIES OR TYPOGRAPHICAL ERRORS. CHANGES ARE PERIODICALLY MADE TO THE INFORMATION HEREIN; THESE CHANGES WILL BE INCORPORATED IN FUTURE REVISIONS OF THIS PUBLICATION. CP CLARE CORPORATION MAY MAKE IMPROVEMENTS AND/OR CHANGES IN THE PRODUCT (S), TECHNICAL SPECIFICATIONS, AND PRODUCT PROMOTIONS DESCRIBED IN THIS PUBLICATION AT ANY TIME WITHOUT NOTICE.

IN NO EVENT SHALL CP CLARE CORPORATION BE LIABLE FOR ANY INCIDENTAL OR CONSEQUENTIAL DAMAGES, LOST PROFITS OR LOST DATA OR ANY INDIRECT DAMAGES EVEN IF CP CLARE CORPORATION HAS BEEN INFORMED OF THE POSSIBILITY THEREOF. CP CLARE CORPORATION MAKES NO ASSERTION OR WARRANTY THAT THE CIRCUITRY AND THE USES THEREOF DISCLOSED HEREIN ARE NON-INFRINGEMENT ON ANY VALID US OR FOREIGN PATENTS. CP CLARE CORPORATION DOES NOT AUTHORIZE OR WARRANT ANY CP CLARE CORPORATION DEVICE FOR USE IN LIFE SUPPORT DEVICES AND/OR SYSTEMS.