

# PML50 Series

## 0.688" (17.5mm) Waterproof LED FlexVolt™ Panel Mount Indicator

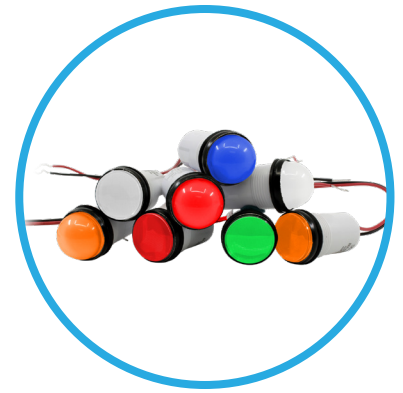

PML50 Series with built-in LED FlexVolt™ technology offers daytime visibility, easy installation in harsh environments

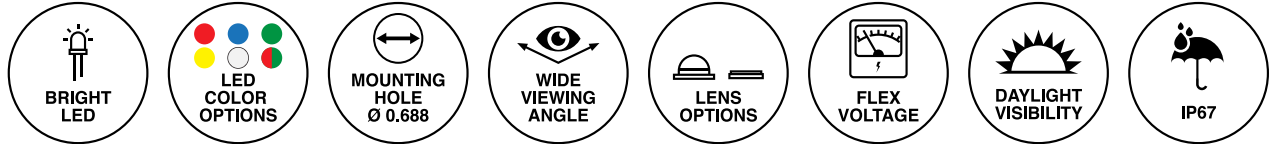

### Application

- Industrial
- Transportation
- People Movers
- Maritime, Oil and Gas Industry
- Automation and Control
- Slot, Gaming and Vending Machines
- Safety and Emergency
- Pilot Instrumentation
- Outdoor Applications

### Key Features

- For panel hole diameter: 0.688" (17.5mm)
- Low profile flat and semi dome lens options for uniform illumination
- Flat lens with a clear diffused lens for increased contrast visibility between on and off
- Semi dome lens with a white diffused lens for optimal side distance viewing
- Designed for extreme, harsh and outdoor environments
- Available in five single colors: red, green, white, blue or yellow and in bi/color: red/green
- Offered with two lens options: Low Profile Flat and Semi Dome
- Resistant to shock and vibration
- Flex voltage (5 VDC to 28 VDC) designed for application flexibility: one solution for several required input voltages
- Wide viewing angle
- Mounting hardware provided: lock washer and hex nut
- Maximum installation torque: 15in/lb
- "Double D" mounting hole prevents any rotation of the indicator while the nut is being installed
- IP67 specification rating protects front panels against entry of dust, rain and moisture
- InGaN and AlInGaP Technology
- Visible LED in direct sunlight with UV resistance lens
- Long lifetime, up to 100k hours
- For custom cable length, connectors or colors contact VCC
- RoHS and REACH Compliant

## Ordering Data

The PML50 Series is available in a range of standard features and options. To specify your Panel Mount Indicator, select one option from each column.

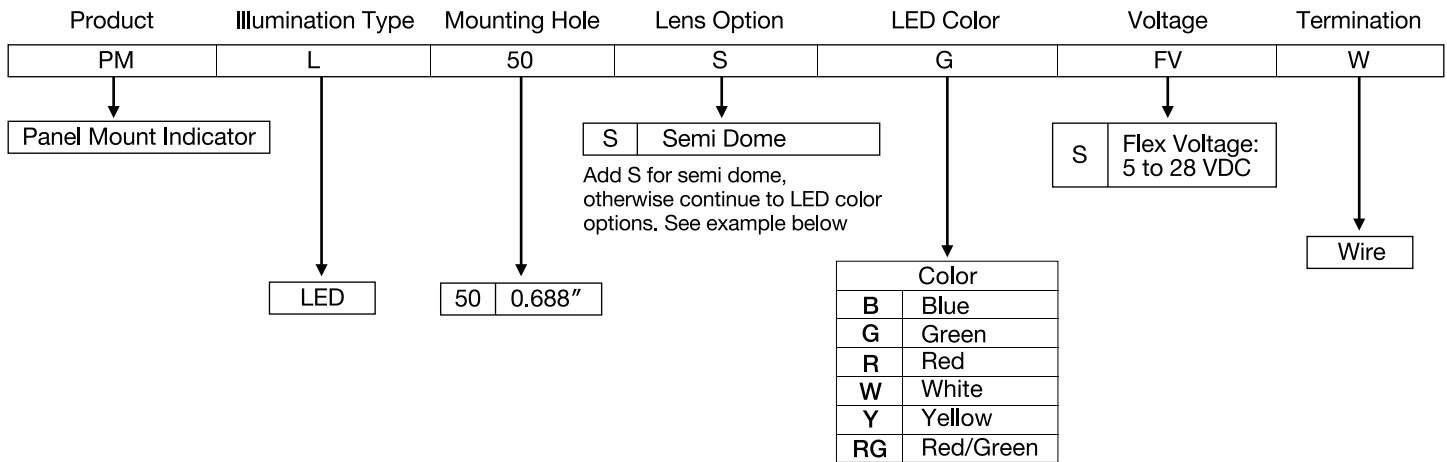

Part Numbers	Color	Lens Option
PML50RFVW	Red	Flat
PML50WFVW	White	Flat
PML50GFVW	Green	Flat
PML50BFVW	Blue	Flat
PML50YFVW	Yellow	Flat
PML50RGFVW	Red/Green	Flat
PML50SRFVW	Red	Semi Dome
PML50SWFVW	White	Semi Dome
PML50SGFVW	Green	Semi Dome
PML50SBFVW	Blue	Semi Dome
PML50SYFVW	Yellow	Semi Dome
PML50SRGFVW	Red/Green	Semi Dome

### Example:

#### PML50SGFVW

PML50 Semi Dome, Green, Flex Voltage, Wire



#### PML50RFVW

PML50 Flat, Red, Flex Voltage, Wire



# Product Dimensions

## Semi Dome Lens

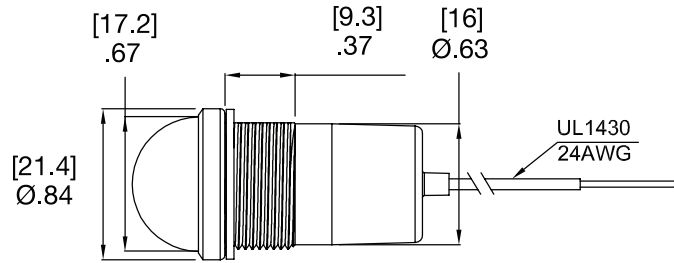
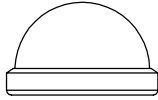

## Flat Lens

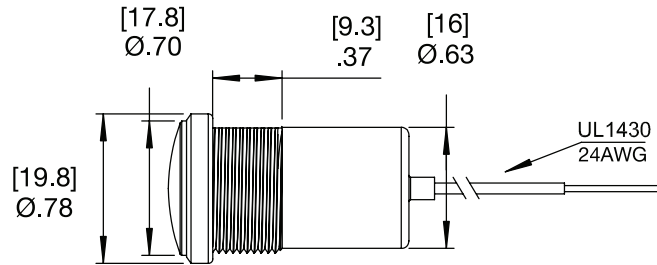

## Recommended Mounting Hole

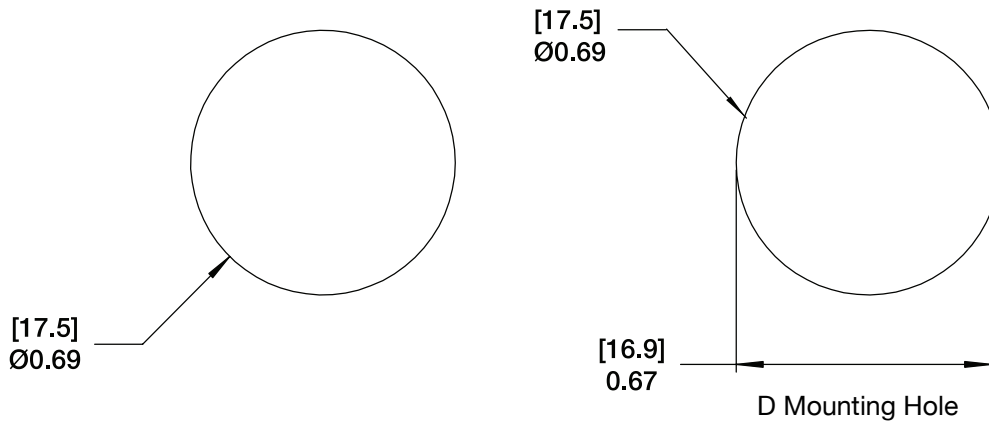

### Notes:

1. All dimensions are in inches [millimeters]
2. Tolerance is  $\pm[0.25]$   $0.01$  unless otherwise noted.
3. The specifications, characteristics and technical data described in the datasheet are subject to change without prior notice.

# Product Dimensions

## Semi Dome Lens

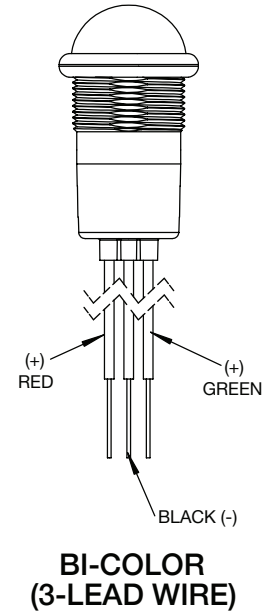
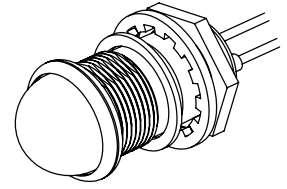
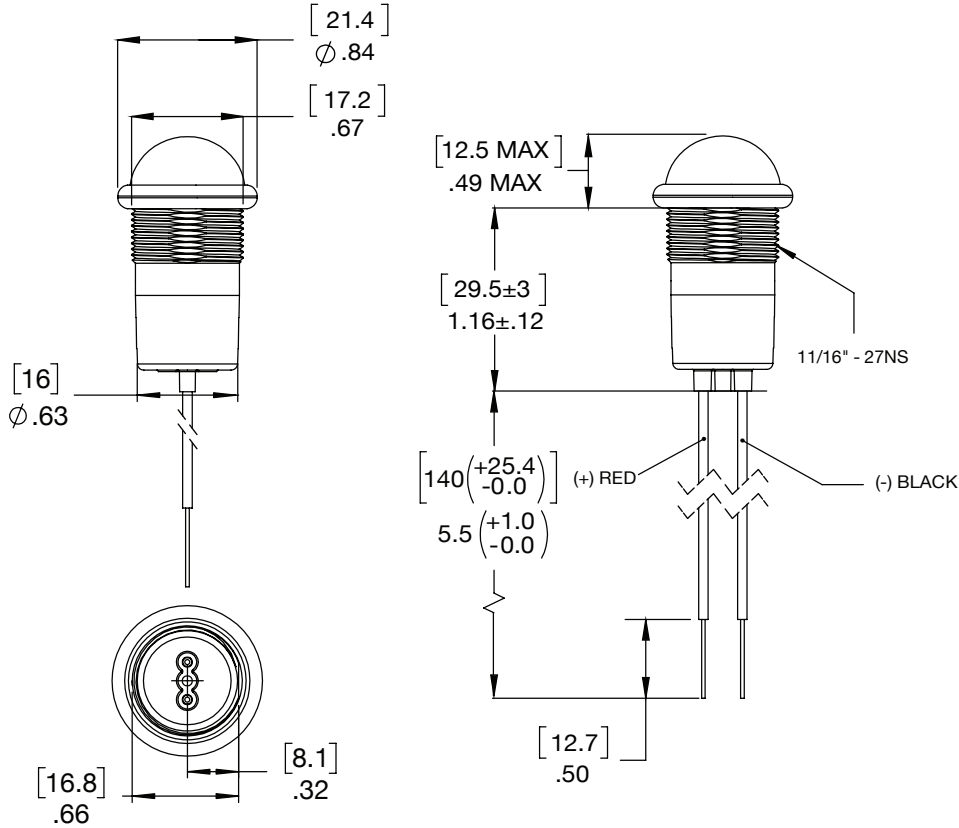

**Notes:**

1. All dimensions are in inches [millimeters]
2. Tolerance is  $\pm[0.25] 0.01$  unless otherwise noted.
3. The specifications, characteristics and technical data described in the datasheet are subject to change without prior notice.

# Product Dimensions

## Flat Lens

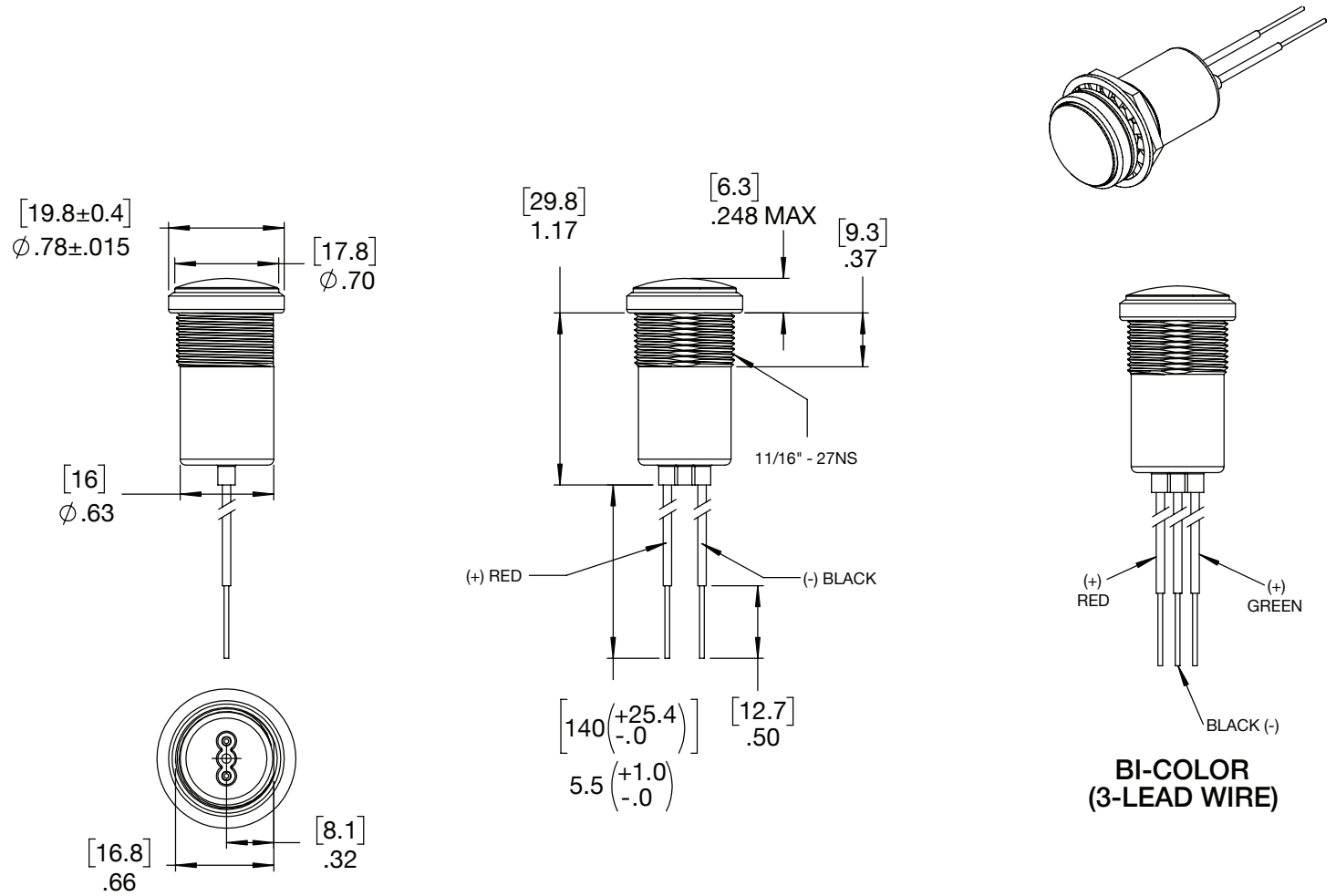

## Mounting Hardware (Included for flat and semi dome lenses)

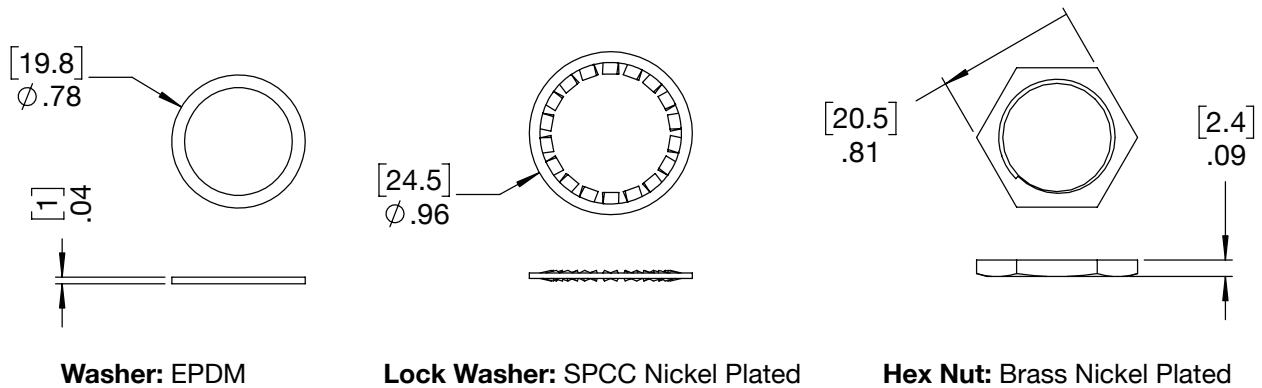

### Notes:

1. All dimensions are in inches [millimeters]
2. Tolerance is  $\pm[0.25]$   $0.01$  unless otherwise noted.
3. The specifications, characteristics and technical data described in the datasheet are subject to change without prior notice.

## Product Specifications

Materials	
Housing	White Polycarbonate UL 94 V-0
Lens	Transparent Polycarbonate UL 94 V-0
	UV Material: Polycarbonate Resin (Semi dome lens only)
Bezel	Plated, Black Color Finish
Wire Leads	Tinned Copper Conductor PVC Insulation
Washer (installed)	EPDM rubber
Lock Washer	SPCC, Nickel Plated
Hex Nut	Brass, Nickel Plated

Installation Specifications	
Mounting Hole ("D" Shape)	11/16" or 0.688" (17.46 mm)
Panel Thickness (max.)	0.156" (3.96 mm)
Wire Leads	24 AWG - UL1430 rated, 5.5" (140 mm) long, stripped .5" Anode (+): Red lead (Single Color) and Green and Red leads (Bicolor)
Mounting Torque	15 in-lbs (17.28 kg-cm)

Electrical Specifications	
Operating Voltage	110-125VAC 120VAC
Operating Current	2mA (max.)

Temperature Specifications	
Operating Temperature	-25°C to +80°C -13°F to +176°F
Storage Temperature	-30°C to +100°C -22°F to +212°F

### Optical Ratings\*

Part Number	Color	Luminance (mcd)
PML50RFVW	Red	950
PML50WFVW	White	2980
PML50GFVW	Green	3640
PML50BFVW	Blue	270
PML50YFVW	Yellow	2020
PML50RGFVW	Red/Green	1130/2380

Part Number	Color	Luminance (mcd)
PML50SRFVW	Red	780
PML50SWFVW	White	1090
PML50SGFVW	Green	1770
PML50SBFVW	Blue	200
PML50SYFVW	Yellow	970
PML50SRGFVW	Red/Green	520/1370

\*Test Parameters: Voltage at 24VDC and Temperature at 25°C or 77°F

## Compliances and Approvals

