

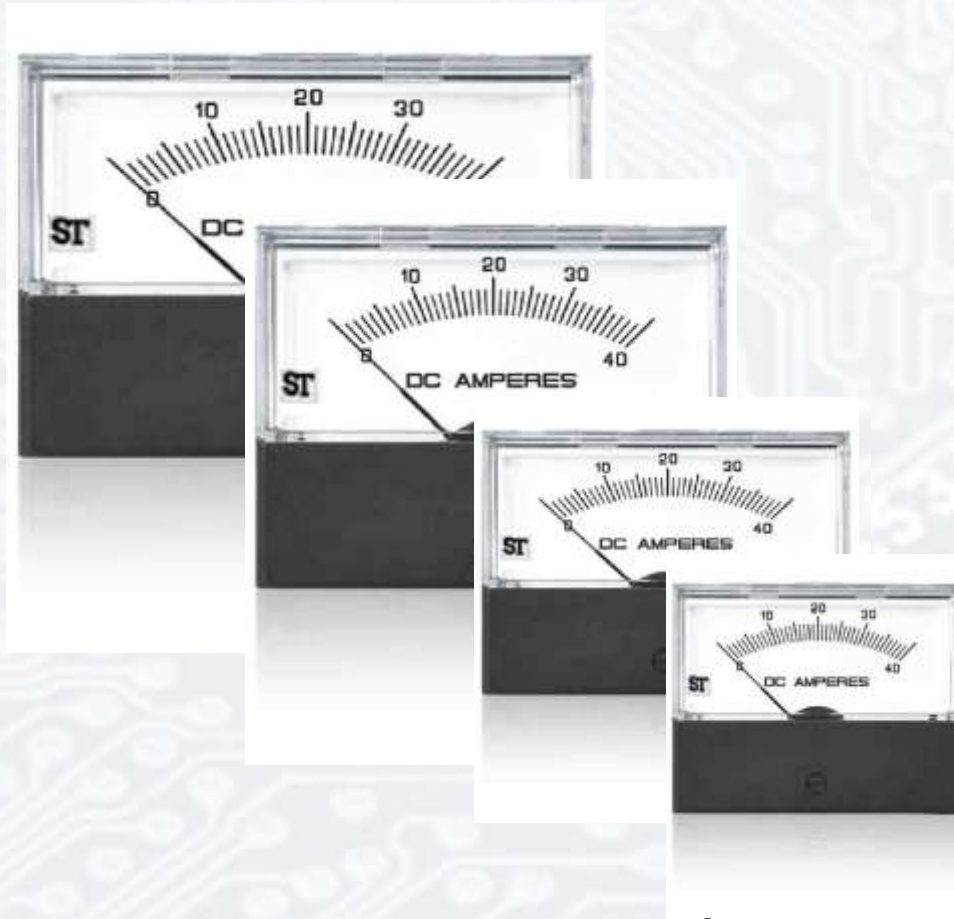

# Technical Data Sheet

## Contender Series meter



The moving iron & moving coil panel meters, sizes 1<sup>000</sup>, 2<sup>000</sup>, 3<sup>000</sup>, 4<sup>000</sup> are housed in a moulded polycarbonate cases which are suitable for the measurement of AC & DC ammeters, voltmeter & frequency meters utilizing a high torque pivot and jewel movement.

### Special Features

- Surface or window mounting.
- Near linear scale.
- Glass filled polycarbonate housing (UL 94 V-0).
- Knife edge pointer.

## Application

The contender range of analog panel meters offers accurate measurement and indication of most electrical & electronics parameters in industry standard 1<sup>000</sup>, 2<sup>000</sup>, 3<sup>000</sup>, 4<sup>000</sup> case sizes. This innovative design features a detachable lower fascia plate which allows the flexibility of either surface or window mounting. The fascia is simply unclipped to achieve the completely flush panel appearance of panel window mounting.

The range offers AC & DC ammeters, voltmeters and frequency meters utilizing a high torque pivot and jewel movement. AC moving coil rectified meters provide 1.5% accuracy of full scale value and features a rear zero adjuster screw for tamper proof installation. AC moving iron meters also provide 1.5% high accuracy and true RMS measurement.

## Functional Areas

- Marine
- Switchgear
- Distribution systems
- Control panels
- Embedded generation
- Energy management
- Building management
- Utility power management
- Process control
- Motor monitoring

## Features

- Measuring and indication of AC amps, volts, frequency and DC signals.
- Surface or window mounting.
- Rear zero adjuster on moving coil meters.
- High torque pivot and jewel movement.
- True RMS measurement meters.
- AC and DC inputs.
- Up to 40A DC direct connected.
- Up to 50A AC direct connected.

(Not applicable for model 112)

## Benefits

- AC moving iron and moving coil mechanisms.
- ANSI standard case sizes.
- Detachable lower fascia plate.
- Easy to modify for distributions.

## Operation

### Moving Coil Meter

These meters offers a centre cored, self shielding moving coil movements using pivots, hairspring and spring jewels. Variations in movement are limited by design. All DC voltmeters are 1000 ohms per volt, moving coil rectified products run at 900 ohms per volt. Milivolt meter use the 5 miliamps/50mV resistance.

### Moving Iron Meter

This clapper type repulsion design utilizes a pivot, hairspring and jewel movement. The bottom jewel is oil filled to provide damping while the top is spring for resilience. All voltmeters are manufactured with internal voltage dropper resistor.

### Frequency Meter

Frequency meters use a 1 mA/350ohm movement driven by an EMC hard frequency conversion circuit.

### Dials, Pointers and Scales

Standard dials are matt white black printed scales and a tubular knife-edge black are balanced within 1% of scale length and feature a highly repeatable flattened arc scale shape, ensuring consistently accurate measurement reading. Dials are interchangeable between the contender range of products using the same input within the published specification of the meter. Options for non standard customer specific dials are available upon request.

## Technical Specifications

### Applicable Standards

<b>Terminal bolts/leads</b>	DIN 46210/46282
<b>Safety requirements and protective measures for Electrical indicating instruments and their accessories</b>	IEC 529, IEC 61010-1
<b>Performance specifications for direct acting indicating analogue electrical measuring instruments and their accessories</b>	IS 1248 IEC 51 ANSI C39.1 1981
<b>UL Compatibility</b>	UL 94 V-0

### Comply with following European directives

2004 / 108 / EC (EMC directive), 2006 / 95/EC ( low voltage directive ) & amendment 93/68/EEC, For CE Marking.

### Scale and Pointer

<b>Pointer</b>	Tube knife - edge pointer			
<b>Pointer deflection</b>	90°			
<b>Scale characteristics</b>	(A) Near Linear above 10% of nominal full Scale value for moving iron  (B) Linear scale for moving coil, frequency, moving coil with rectifier			
<b>Scale division</b>	Coarse - fine			
<b>Scale length</b>	112	212	312	412
	32.56 mm	49.03 mm	57.22mm	90.14 mm

## Nominal Range of use

<b>Ambient Temperature</b>	0 ...40 °C
<b>Position of use</b>	Vertical ± 5°
<b>Frequency</b>	FN ± 10%
<b>External Magnetic Field</b>	At 0.4 kA/m

## Mechanical Data

<b>Case details</b>	Moulded case suitable for mounting in Control / switchgear panels Machinery consoles.
<b>Case material</b>	Polycarbonate, flame retardant and drip proof as per UL 94 V-0.
<b>Front window</b>	Polycarbonate (Shatter proof & transparent)
<b>Colour of front cover</b>	Black
<b>Position of use</b>	Vertical
<b>Panel fixing</b>	Fixing Stud
<b>Panel thickness</b>	≤ 10 mm

### Terminals

<b>Voltmeters and Ammeters &amp; Frequency meters</b>	Terminal 10-32 UNF, Washer 10-32 UNF
<b>Fixing</b>	Surface mounting: 4 corner studs, 4-40 UNC  Rear of panel mounting: 2 through hole mounts (Except Model 112)

## Reference Conditions

<b>Accuracy</b>	According to IEC 51/DIN EN 60051
<b>DC Ammeters &amp; Voltmeters</b>	1.5% 0 to 100% of full scale deflection
<b>AC Ammeters &amp; Voltmeters</b>	Moving iron: 1.5% 10 to 100% of full scale deflection Moving coil: 1.5% 0 to 100% of full scale deflection
<b>Frequency Meters</b>	0.5% of end scale value
<b>Ambient temperature</b>	23 °C ± 2°C
<b>Position of use</b>	Nominal position ±1°
<b>Input Waveform</b>	Rated value of measured quantity sine wave, distortion factor ≤ 5%
<b>Frequency</b>	45 - 65Hz
<b>Other Conditions</b>	IEC 51/DIN EN 60051



## Electrical Data

DC moving coil Ammeters	50 mA to 40 A
DC moving coil Voltmeters	50 mV to 600 V
AC moving coil Ammeters (VQ)	1 mA to 100 mA
AC moving coil Voltmeters (VQ)	6 V to 600 V
AC moving iron Ammeters (EQ)	100 mA to 50 A
AC moving coil Voltmeters (EQ)	6 V to 600 V
Frequency Meters	45-50-55Hz, 55-60-65Hz, 45-55-65Hz, 360-440Hz
Overload	Continuous 1.2

## Environmental Conditions

Climatic Suitability	Climate category II as per IEC 60051 (climatic class 3 according to VDE/VDI 3540)
Operating Temperature	0°C... +40°C
Storage temperature	-20°C ...+55°C
Relative humidity	25% to 80% nominal range of use
Shock resistance	15 g, for pulse duration 11ms
Vibration resistance	ANSI C39.1 cl. 5. 13

## Options

Case	
Front Window	Shatter Proof Polycarbonate (Transparent)
Color of Front cover	Black
Dial	
Blank dial	With initial and end values marked
Special markings	Numbering/ Lettering
Division dials	Basic divisions without numbering
Color markings/bands	Red or green
Over rang (Moving Iron Ammeter)	Two, three and five times over range

## Standard Measuring Ranges

DC moving coil Ammeters	50 mA to 40 A
DC moving coil Voltmeters	50 mV to 600 V
AC moving coil Ammeters (VQ)	1 mA to 100 mA
AC moving coil Voltmeters (VQ)	6 V to 600 V
□ AC moving iron Ammeters (EQ)	100 mA to 50 A
□ AC moving coil Voltmeters (EQ)	6 V to 600 V
Frequency Meters	45-50-55Hz, 55-60-65Hz, 45-55-65Hz, 360-440Hz

□ 112 size not applicable

## Accessories

### Safety Precautions

- 1) Instruments with damaged window or glasses must be disconnected from the mains.
- 2) Adequate safety clearance must be maintained to control panel fasteners and to sheet metal housing. If non - insulated connector wires are used.
- 3) Instruments to be used in grounded panel.

Electrical Connections

DC Amps - Self Contained

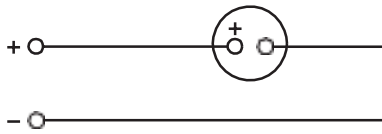

DC Amps - For use with external shunt

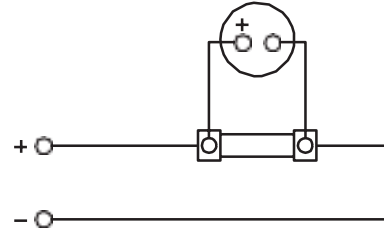

DC Volts

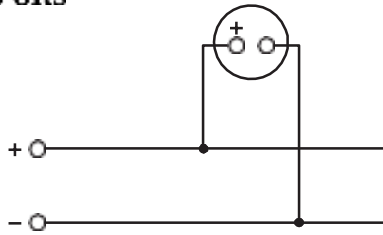

AC Amps - Self Contained

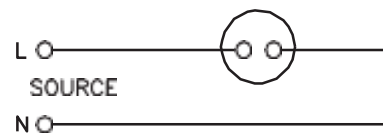

AC Amps - For use with Current Transformer

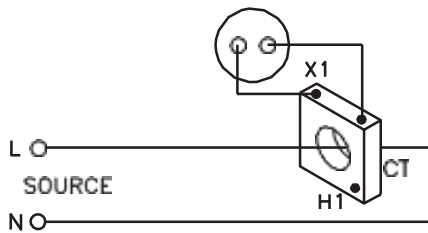

AC Volts

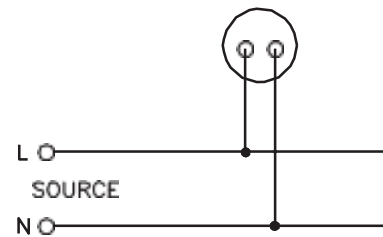

Frequency Meter

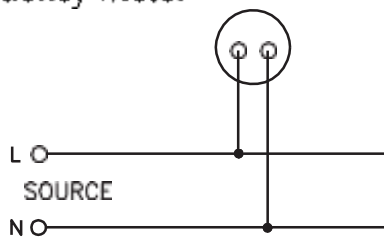

Dimensions

Surface Mount Cut Out

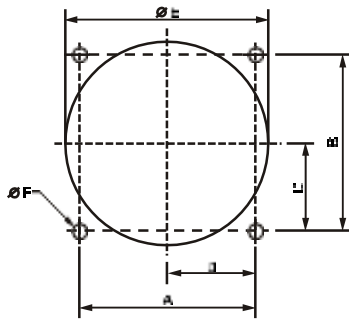

Surface Mount Cut Out

	A	B	C	D	E	F
112 (inch)	1.31	1.31	0.66	0.66	1.56	0.14
112 (mm)	33.27	33.27	16.76	16.76	39.62	3.56
212 (inch)	1.88	1.88	0.94	0.94	2.16	0.14
212 (mm)	47.75	47.75	23.88	23.88	54.86	3.56
312 (inch)	2.25	2.25	0.92	1.12	2.16	0.14
312 (mm)	57.15	57.15	23.37	28.45	54.85	3.56
412 (inch)	4	3.56	1.54	2	2.69	0.14
412 (mm)	101.6	90.42	39.12	50.8	68.33	3.56

Window Mounting Cut Out

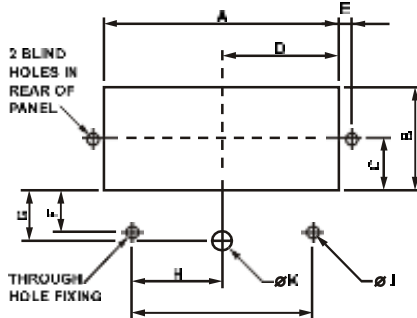

Window Mounting Cut Out

	A	B	C	D	E	F	G	H	I	J	K
112 (inch)	2.17	0.94	0.47	1.08	0.16	-	0.47	-	-	-	0.23
112 (mm)	55.12	23.88	11.94	27.43	4.06	-	11.94	-	-	-	5.84
212 (inch)	2.92	1.28	0.63	1.46	0.16	0.64	0.81	1.13	2.26	0.14	0.23
212 (mm)	74.17	32.51	16.0	37.08	4.06	16.26	20.57	28.70	57.40	3.56	5.84
312 (inch)	3.63	1.61	0.8	1.82	0.16	0.67	0.8	1.48	2.96	0.14	0.23
312 (mm)	92.20	40.89	20.32	46.23	4.06	17.20	20.35	37.59	75.18	3.56	5.84
412 (inch)	5.05	2.36	1.18	2.52	0.19	0.85	1.07	2.11	4.22	0.14	0.23
412 (mm)	128.27	59.94	29.97	64.01	4.83	21.59	21.9	53.59	107.19	3.56	5.84

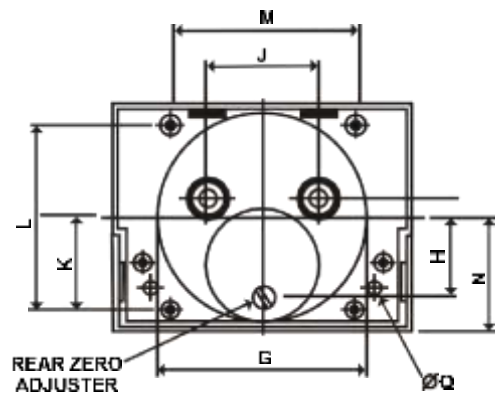
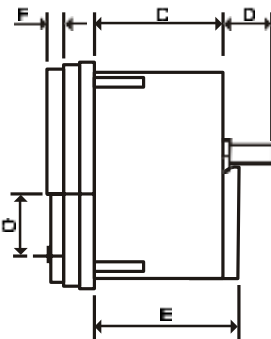
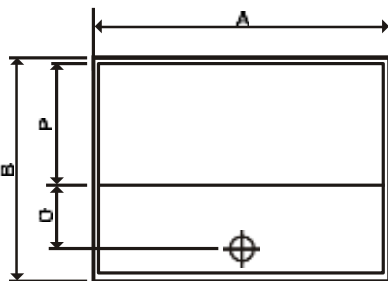

Model

	A	B	C	D	E	F	G	H	I	J	K	L	M	N	O	P	Q
112 (inch)	2.26	1.75	1.3	0.5	-	0.13	1.50	0.57	0.15	0.95	0.65	1.30	1.30	0.85	0.53	0.9	0.14
112 (mm)	57.4	44.45	33.0	12.7	-	3.55	38.1	14.48	3.81	24.13	16.60	33.02	33.02	21.60	13.46	22.86	3.56
212 (inch)	3.0	2.30	1.3	0.5	1.46	0.15	2.12	0.81	0.2	1.12	0.94	1.88	1.88	1.16	0.63	1.27	0.156
212 (mm)	76.2	73.9	33.0	12.7	37.08	3.81	53.8	20.57	5.08	28.4	23.88	47.75	47.75	29.46	16	32.26	4
312 (inch)	3.75	2.91	1.3	0.5	1.46	0.16	2.12	0.81	0.2	1.12	0.92	2.25	2.25	1.25	0.81	1.42	0.23
312 (mm)	95.25	73.91	33.0	12.7	37.08	4.06	53.8	20.57	5.08	28.45	23.37	57.15	57.15	31.75	20.57	36.07	5.84
412 (inch)	5.10	4	1.3	0.5	1.46	0.51	2.65	1.02	-	1.12	1.53	3.55	4	2	0.96	2.30	0.23
412 (mm)	129.54	101.6	33.0	12.7	37.08	12.95	67.31	25.91	-	28.45	38.86	90.17	101.6	45.5	21.9	58.42	5.84

# Smartlook/Contender/Anush Series Coding

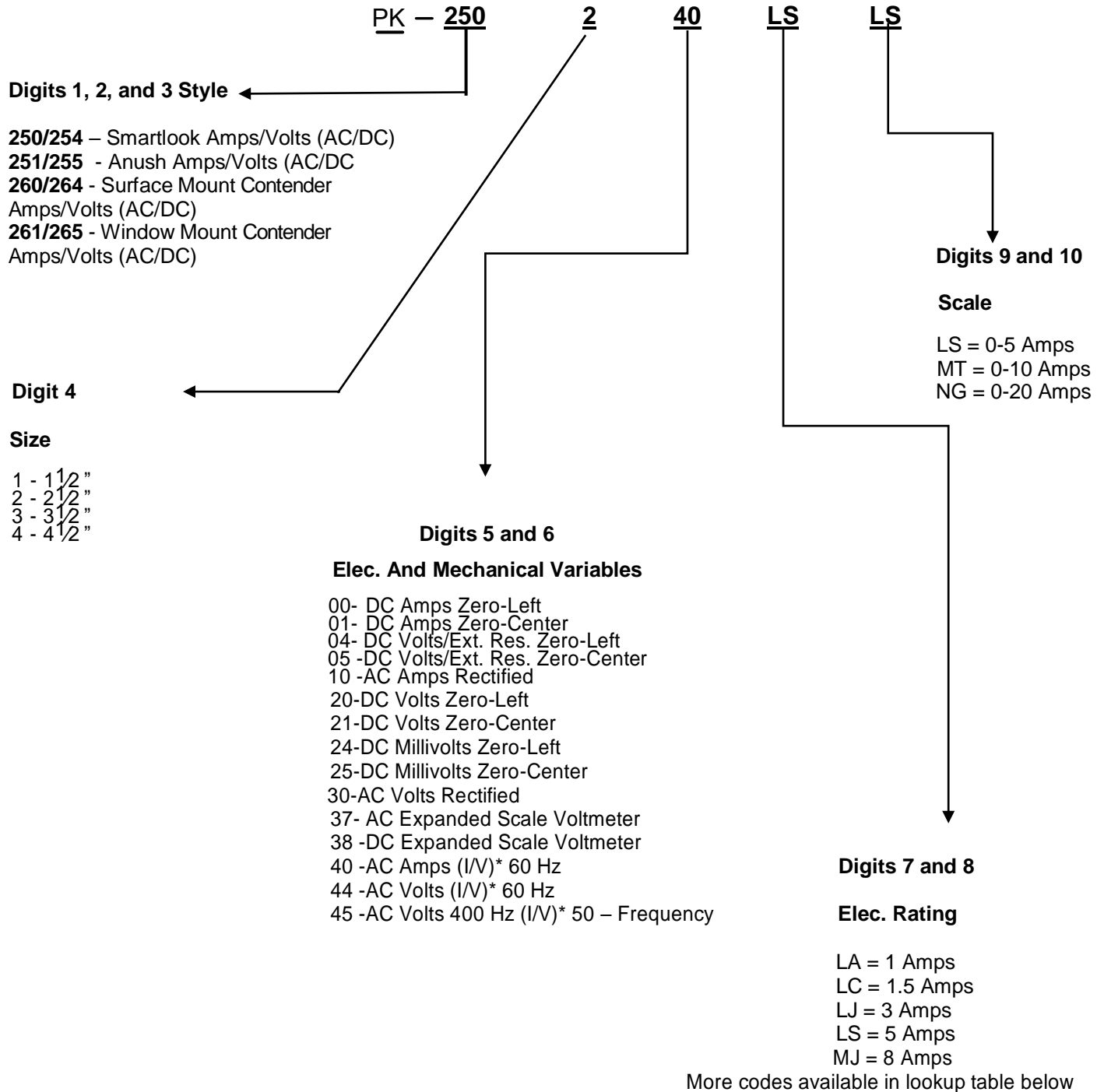

**Note:** Smartlook available in 2.5" and 3.5"; Anush available in 1.5" and 2.5" and Contender available in all four sizes (1.5", 2.5", 3.5" and 4.5")

### Lookup Table for Codes (Digits 7 and 8 and Digits 9 and 10)

Code	Range	Code	Range	Code	Range	Code	Range	Code	Range	Code	Range
CF	0-20 $\mu$	CY	0-50 $\mu$								
DR	0-100 $\mu$										
EA	0-200 $\mu$	EM	0-500 $\mu$	EW	0-800 $\mu$						
FA	0-1 m	FD	0-1.5 m	FG	0-2 m	FN	0-3 m	FX	0-5 m		
GZ	0-10 m										
HC	0-15 m	HF	0-20 m	HJ	0-25 m	HM	0-30 m	HY	0-50 m		
JJ	0-80 m	JR	0-100 m	JX	0-150 m						
KA	0-200 m	KD	0-250 m	KG	0-300 m	KM	0-500 m	KU	0-750 m	KW	0-800 m
LA	0-1	LC	0-1.5	LJ	0-3	LS	0-5				
MJ	0-8	MT	0-10								
ND	0-15	NG	0-20	NL	0-30	NP	0-40	NT	0-50	NW	0-60
PB	0-75	PD	0-80	PK	0-100	PZ	0-150				
RL	0-200	RS	0-250	RX	0-300						
SC	0-400	SF	0-500	SJ	0-600	SM	0-750	SN	0-800	SS	0-1000
TC	0-1500	TM	0-2000								
VA	0-1 kilo	VB	0-1.2 kilo	VC	0-1.5 kilo	VE	0-2 kilo	VJ	0-3 kilo		



For more details and product codes, please contact our local office



**sifam tinsley**  
PRECISION INSTRUMENTATION

**Sifam Tinsley Instrumentation Inc.**  
3105, Creekside Village Drive,  
Suite No. 801, Kennesaw,  
Georgia 30144 (USA)  
E-mail Id : [psk@sifamtinsley.com](mailto:psk@sifamtinsley.com)  
Web : [www.sifamtinsley.com](http://www.sifamtinsley.com)  
Contact No. : +1 404 736 4903

**Sifam Tinsley Instrumentation Ltd**  
Unit 1 Warner Drive,  
Springwood Industrial Estate  
Braintree, Essex, UK, CM72YW  
E-mail: [salcs@sifamtinsley.com](mailto:salcs@sifamtinsley.com)  
Web: [www.sifamtinsley.com/uk](http://www.sifamtinsley.com/uk)  
Contact: +44(0)1803615139