

PDTA124X series

PNP resistor-equipped transistors; R1 = 22 k Ω , R2 = 47 k Ω

Rev. 08 — 3 September 2009

Product data sheet

1. Product profile

1.1 General description

PNP Resistor-Equipped Transistors (RET) family.

Table 1. Product overview

Type number	Package			NPN complement
	NXP	JEITA	JEDEC	
PDTA124XE	SOT416	SC-75	-	PDTC124XE
PDTA124XEF	SOT490	SC-89	-	PDTC124XEF
PDTA124XK	SOT346	SC-59A	TO-236	PDTC124XK
PDTA124XM	SOT883	SC-101	-	PDTC124XM
PDTA124XS ^[1]	SOT54	SC-43A	TO-92	PDTC124XS
PDTA124XT	SOT23	-	TO-236AB	PDTC124XT
PDTA124XU	SOT323	SC-70	-	PDTC124XU

[1] Also available in SOT54A and SOT54 variant packages (see [Section 2](#))

1.2 Features

- Built-in bias resistors
- Simplifies circuit design
- 100 mA output current capability
- Reduces component count
- Reduces pick and place costs

1.3 Applications

- Digital applications
- Controlling IC inputs
- Cost-saving alternative for BC857 series in digital applications
- Switching loads

1.4 Quick reference data

Table 2. Quick reference data

Symbol	Parameter	Conditions	Min	Typ	Max	Unit
V _{CEO}	collector-emitter voltage	open base	-	-	-50	V
I _O	output current (DC)		-	-	-100	mA
R1	bias resistor 1 (input)		15.4	22	28.6	k Ω
R2/R1	bias resistor ratio		1.7	2.1	2.6	

2. Pinning information

Table 3. Pinning

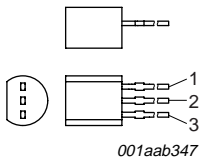
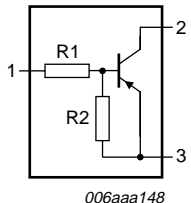
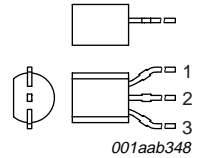
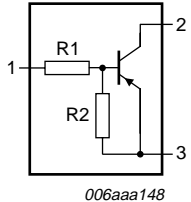
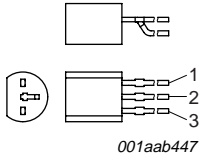
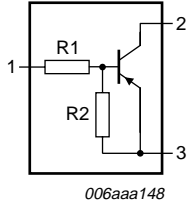
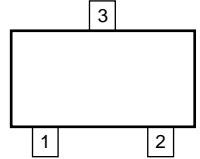
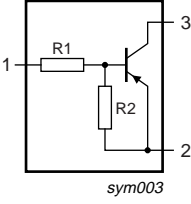
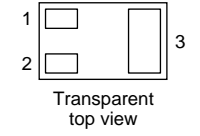
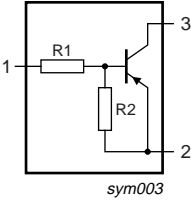
Pin	Description	Simplified outline	Symbol
SOT54			
1	input (base)	 <p>001aab347</p>	 <p>006aaa148</p>
2	output (collector)		
3	GND (emitter)		
SOT54A			
1	input (base)	 <p>001aab348</p>	 <p>006aaa148</p>
2	output (collector)		
3	GND (emitter)		
SOT54 variant			
1	input (base)	 <p>001aab447</p>	 <p>006aaa148</p>
2	output (collector)		
3	GND (emitter)		
SOT23; SOT323; SOT346; SOT416; SOT490			
1	input (base)	 <p>006aaa144</p>	 <p>sym003</p>
2	GND (emitter)		
3	output (collector)		
SOT883			
1	input (base)	 <p>Transparent top view</p>	 <p>sym003</p>
2	GND (emitter)		
3	output (collector)		

3. Ordering information

Table 4. Ordering information

Type number	Package		
	Name	Description	Version
PDTA124XE	SC-75	plastic surface mounted package; 3 leads	SOT416
PDTA124XEF	SC-89	plastic surface mounted package; 3 leads	SOT490
PDTA124XK	SC-59A	plastic surface mounted package; 3 leads	SOT346
PDTA124XM	SC-101	leadless ultra small plastic package; 3 solder lands; body 1.0 × 0.6 × 0.5 mm	SOT883
PDTA124XS ^[1]	SC-43A	plastic single-ended leaded (through hole) package; 3 leads	SOT54
PDTA124XT	-	plastic surface mounted package; 3 leads	SOT23
PDTA124XU	SC-70	plastic surface mounted package; 3 leads	SOT323

[1] Also available in SOT54A and SOT54 variant packages (see [Section 2](#) and [Section 9](#))

4. Marking

Table 5. Marking codes

Type number	Marking code ^[1]
PDTA124XE	31
PDTA124XEF	31
PDTA124XK	44
PDTA124XM	DK
PDTA124XS	TA124X
PDTA124XT	*47
PDTA124XU	*44

[1] * = -: made in Hong Kong
 * = p: made in Hong Kong
 * = t: made in Malaysia
 * = W: made in China

5. Limiting values

Table 6. Limiting values

In accordance with the Absolute Maximum Rating System (IEC 60134).

Symbol	Parameter	Conditions	Min	Max	Unit	
V _{CBO}	collector-base voltage	open emitter	-	-50	V	
V _{CEO}	collector-emitter voltage	open base	-	-50	V	
V _{EBO}	emitter-base voltage	open collector	-	-7	V	
V _I	input voltage					
	positive		-	+7	V	
	negative		-	-40	V	
I _O	output current (DC)		-	-100	mA	
I _{CM}	peak collector current		-	-100	mA	
P _{tot}	total power dissipation	T _{amb} ≤ 25 °C				
	SOT416		[1]	-	150	mW
	SOT490		[1][2]	-	250	mW
	SOT346		[1]	-	250	mW
	SOT883		[2][3]	-	250	mW
	SOT54		[1]	-	500	mW
	SOT23		[1]	-	250	mW
	SOT323		[1]	-	200	mW
	T _{stg}	storage temperature		-65	+150	°C
T _j	junction temperature		-	150	°C	
T _{amb}	ambient temperature		-65	+150	°C	

[1] Device mounted on an FR4 Printed-Circuit Board (PCB), single-sided copper, tin-plated and standard footprint.

[2] Reflow soldering is the only recommended soldering method.

[3] Device mounted on an FR4 PCB with 60 μ m copper strip line, standard footprint.

6. Thermal characteristics

Table 7. Thermal characteristics

Symbol	Parameter	Conditions	Min	Typ	Max	Unit
$R_{th(j-a)}$	thermal resistance from junction to ambient	in free air				
	SOT416		[1]	-	833	K/W
	SOT490		[1][2]	-	500	K/W
	SOT346		[1]	-	500	K/W
	SOT883		[2][3]	-	500	K/W
	SOT54		[1]	-	250	K/W
	SOT23		[1]	-	500	K/W
	SOT323		[1]	-	625	K/W

[1] Device mounted on an FR4 PCB, single-sided copper, tin-plated and standard footprint.

[2] Reflow soldering is the only recommended soldering method.

[3] Device mounted on an FR4 PCB with 60 μm copper strip line, standard footprint.

7. Characteristics

Table 8. Characteristics

$T_{amb} = 25\text{ °C}$ unless otherwise specified

Symbol	Parameter	Conditions	Min	Typ	Max	Unit
I_{CBO}	collector-base cut-off current	$V_{CB} = -50\text{ V}; I_E = 0\text{ A}$	-	-	-100	nA
I_{CEO}	collector-emitter cut-off current	$V_{CE} = -30\text{ V}; I_B = 0\text{ A}$	-	-	-1	μA
		$V_{CE} = -30\text{ V}; I_B = 0\text{ A}; T_j = 150\text{ °C}$	-	-	-50	μA
I_{EBO}	emitter-base cut-off current	$V_{EB} = -5\text{ V}; I_C = 0\text{ A}$	-	-	-120	μA
h_{FE}	DC current gain	$V_{CE} = -5\text{ V}; I_C = -5\text{ mA}$	80	-	-	
V_{CEsat}	collector-emitter saturation voltage	$I_C = -10\text{ mA}; I_B = -0.5\text{ mA}$	-	-	-150	mV
$V_{I(off)}$	off-state input voltage	$V_{CE} = -5\text{ V}; I_C = -100\text{ μA}$	-	-0.8	-0.5	V
$V_{I(on)}$	on-state input voltage	$V_{CE} = -0.3\text{ V}; I_C = -2\text{ mA}$	-2	-1.1	-	V
R1	bias resistor 1 (input)		15.4	22	28.6	kΩ
R2/R1	bias resistor ratio		1.7	2.1	2.6	
C_c	collector capacitance	$V_{CB} = -10\text{ V}; I_E = i_e = 0\text{ A}; f = 1\text{ MHz}$	-	-	3	pF

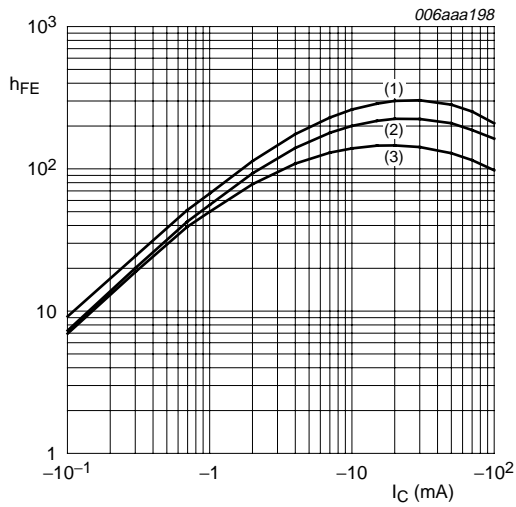

$V_{CE} = -5\text{ V}$
 (1) $T_{amb} = 100\text{ }^{\circ}\text{C}$
 (2) $T_{amb} = 25\text{ }^{\circ}\text{C}$
 (3) $T_{amb} = -40\text{ }^{\circ}\text{C}$

Fig 1. DC current gain as a function of collector current; typical values

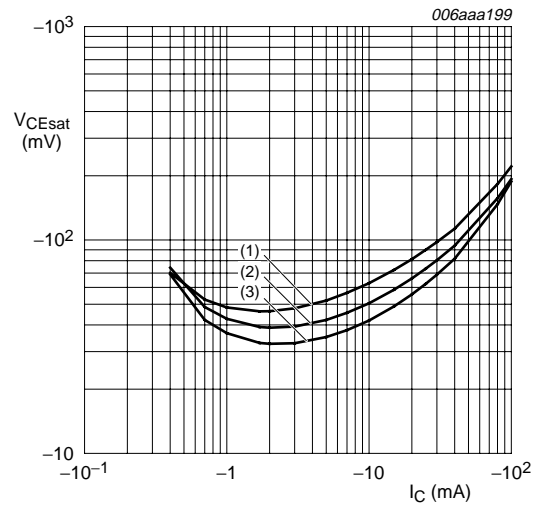

$I_C/I_B = 20$
 (1) $T_{amb} = 100\text{ }^{\circ}\text{C}$
 (2) $T_{amb} = 25\text{ }^{\circ}\text{C}$
 (3) $T_{amb} = -40\text{ }^{\circ}\text{C}$

Fig 2. Collector-emitter saturation voltage as a function of collector current; typical values

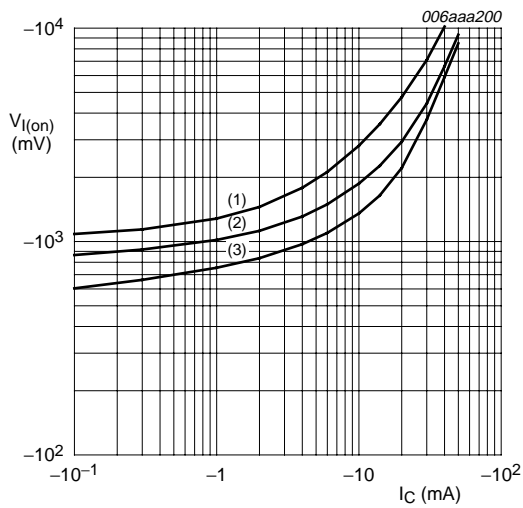

$V_{CE} = -0.3\text{ V}$
 (1) $T_{amb} = -40\text{ }^{\circ}\text{C}$
 (2) $T_{amb} = 25\text{ }^{\circ}\text{C}$
 (3) $T_{amb} = 100\text{ }^{\circ}\text{C}$

Fig 3. On-state input voltage as a function of collector current; typical values

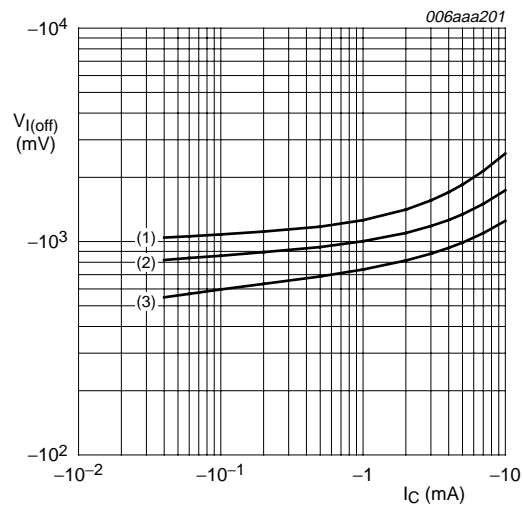

$V_{CE} = -5\text{ V}$
 (1) $T_{amb} = -40\text{ }^{\circ}\text{C}$
 (2) $T_{amb} = 25\text{ }^{\circ}\text{C}$
 (3) $T_{amb} = 100\text{ }^{\circ}\text{C}$

Fig 4. Off-state input voltage as a function of collector current; typical values

8. Package outline

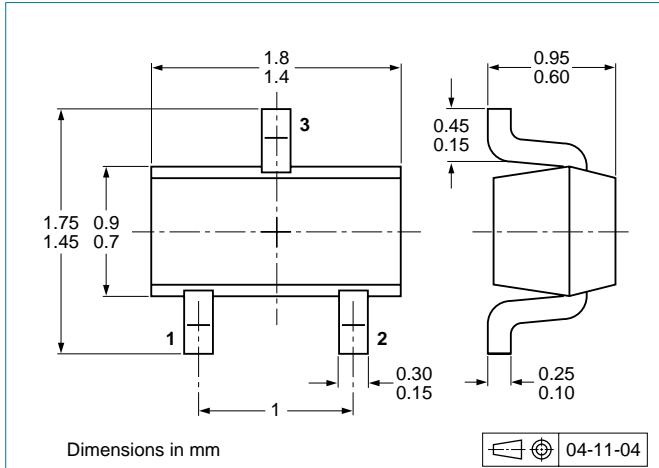

Fig 5. Package outline SOT416 (SC-75)

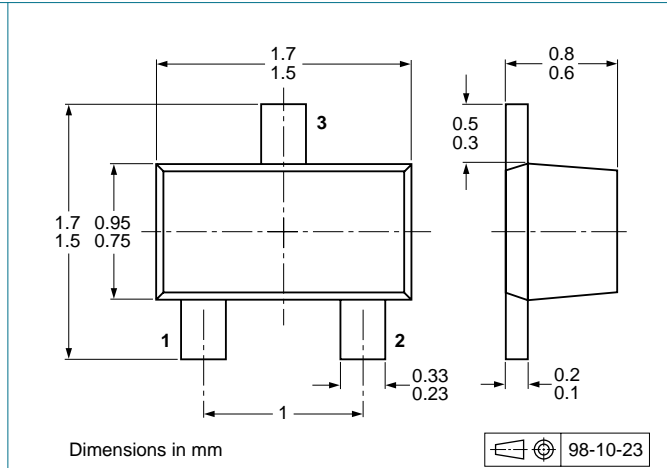

Fig 6. Package outline SOT490 (SC-89)

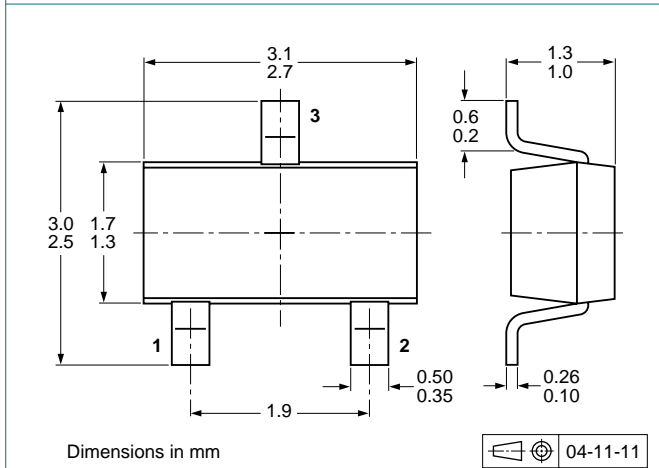

Fig 7. Package outline SOT346 (SC-59A/TO-236)

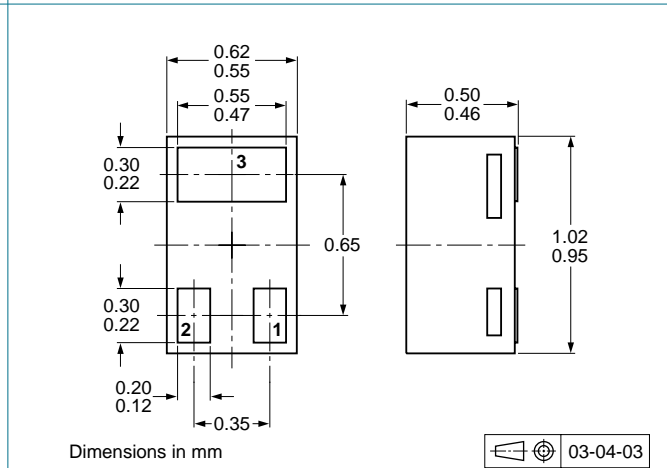

Fig 8. Package outline SOT883 (SC-101)

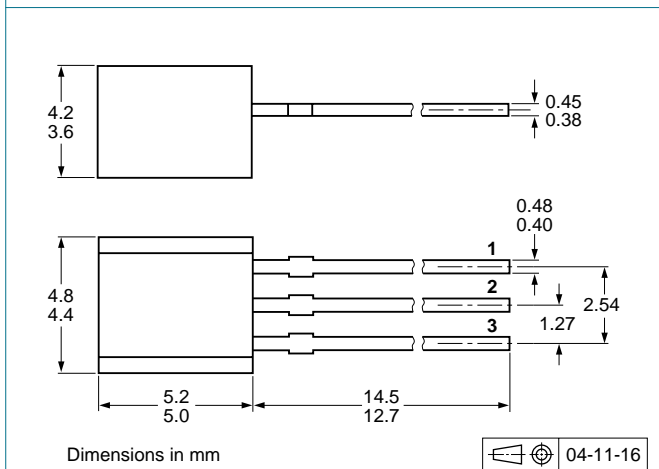

Fig 9. Package outline SOT54 (SC-43A/TO-92)

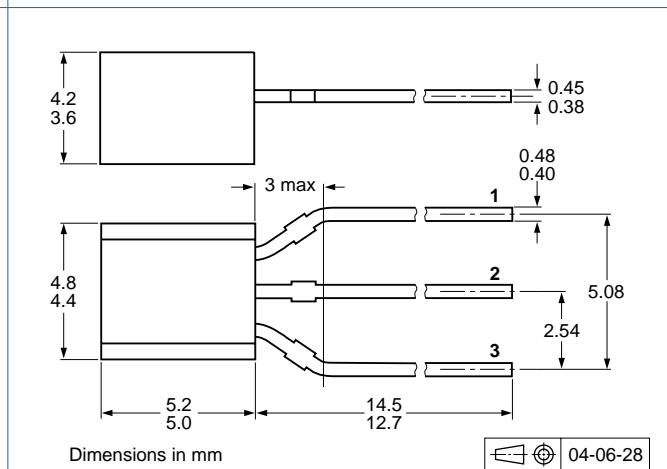

Fig 10. Package outline SOT54A

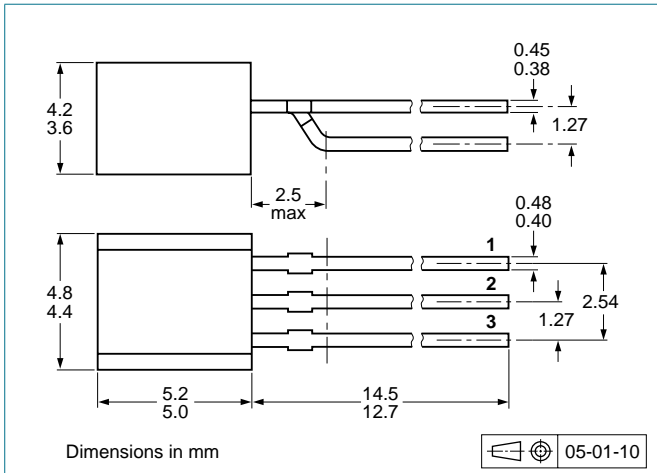

Fig 11. Package outline SOT54 variant

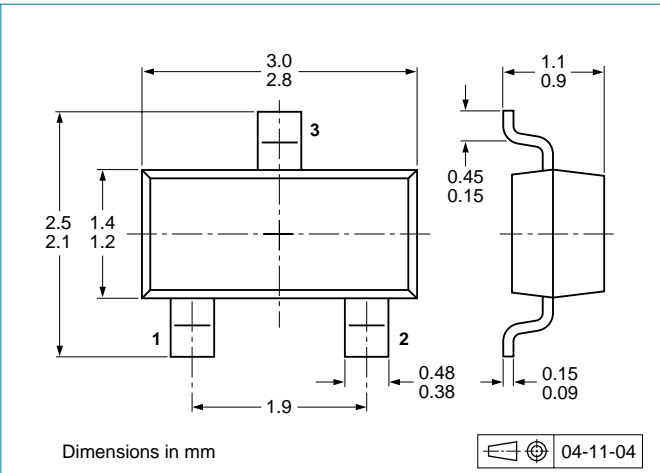

Fig 12. Package outline SOT23 (TO-236AB)

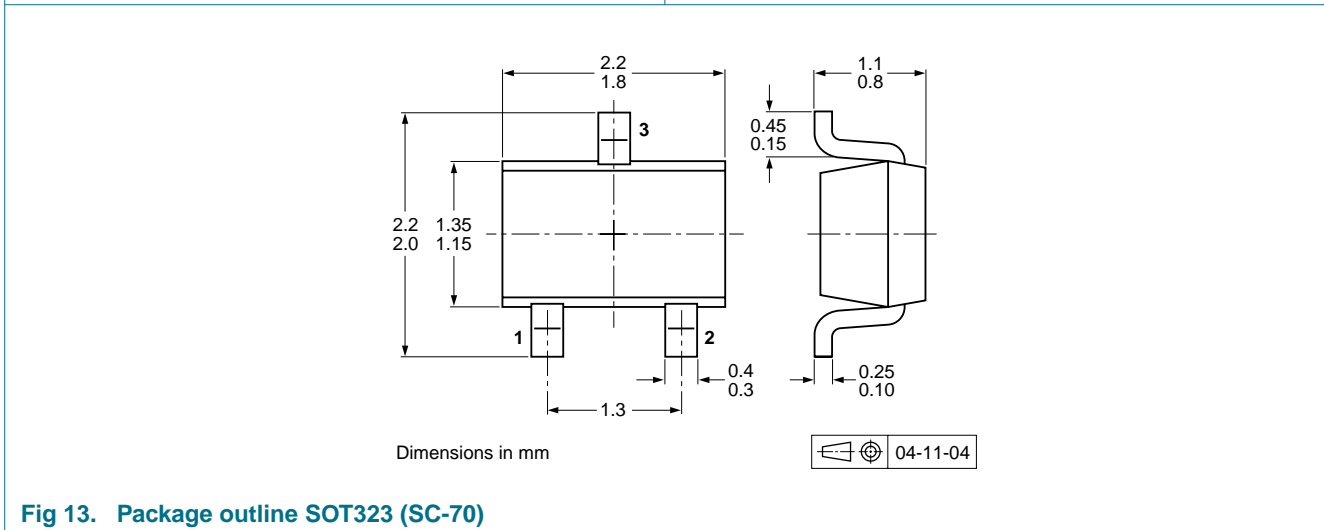

Fig 13. Package outline SOT323 (SC-70)

9. Packing information

Table 9. Packing methods

The indicated -xxx are the last three digits of the 12NC ordering code.^[1]

Type number	Package	Description	Packing quantity			
			3000	4000	5000	10000
PDTA124XE	SOT416	4 mm pitch, 8 mm tape and reel	-115	-	-	-135
PDTA124XEF	SOT490	4 mm pitch, 8 mm tape and reel	-	-115	-	-
PDTA124XK	SOT346	4 mm pitch, 8 mm tape and reel	-115	-	-	-135
PDTA124XM	SOT883	2 mm pitch, 8 mm tape and reel	-	-	-	-315
PDTA124XS	SOT54	bulk, straight leads	-	-	-412	-
	SOT54A	tape and reel, wide pitch	-	-	-	-116
		tape ammpack, wide pitch	-	-	-	-126
	SOT54 variant	bulk, delta pinning	-	-	-112	-
PDTA124XT	SOT23	4 mm pitch, 8 mm tape and reel	-215	-	-	-235
PDTA124XU	SOT323	4 mm pitch, 8 mm tape and reel	-115	-	-	-135

[1] For further information and the availability of packing methods, see [Section 12](#).

10. Revision history

Table 10. Revision history

Document ID	Release date	Data sheet status	Change notice	Supersedes
PDTA124X_SER_8	20090903	Product data sheet	-	PDTA124X_SER_7
Modifications:	<ul style="list-style-type: none"> This data sheet was changed to reflect the new company name NXP Semiconductors, including new legal definitions and disclaimers. No changes were made to the technical content 			
PDTA124X_SER_7	20050811	Product data sheet	-	PDTA124X_SERIES_6
PDTA124X_SERIES_6	20040804	Product specification	-	PDTA124X_SERIES_5
PDTA124X_SERIES_5	20040407	Product specification	-	PDTA124X_SERIES_4
PDTA124X_SERIES_4	20030414	Product specification	-	PDTA124XE_3 PDTA124XEF_2
PDTA124XE_3	19990521	Product specification	-	PDTA124XE_2
PDTA124XE_2	19981125	Product specification	-	PDTA124XE_1
PDTA124XE_1	19971215	Product specification	-	-
PDTA124XEF_2	19990525	Preliminary specification	-	PDTA124XEF_1
PDTA124XEF_1	19981116	Preliminary specification	-	-

11. Legal information

11.1 Data sheet status

Document status ^{[1][2]}	Product status ^[3]	Definition
Objective [short] data sheet	Development	This document contains data from the objective specification for product development.
Preliminary [short] data sheet	Qualification	This document contains data from the preliminary specification.
Product [short] data sheet	Production	This document contains the product specification.

[1] Please consult the most recently issued document before initiating or completing a design.

[2] The term 'short data sheet' is explained in section "Definitions".

[3] The product status of device(s) described in this document may have changed since this document was published and may differ in case of multiple devices. The latest product status information is available on the Internet at URL <http://www.nxp.com>.

11.2 Definitions

Draft — The document is a draft version only. The content is still under internal review and subject to formal approval, which may result in modifications or additions. NXP Semiconductors does not give any representations or warranties as to the accuracy or completeness of information included herein and shall have no liability for the consequences of use of such information.

Short data sheet — A short data sheet is an extract from a full data sheet with the same product type number(s) and title. A short data sheet is intended for quick reference only and should not be relied upon to contain detailed and full information. For detailed and full information see the relevant full data sheet, which is available on request via the local NXP Semiconductors sales office. In case of any inconsistency or conflict with the short data sheet, the full data sheet shall prevail.

11.3 Disclaimers

General — Information in this document is believed to be accurate and reliable. However, NXP Semiconductors does not give any representations or warranties, expressed or implied, as to the accuracy or completeness of such information and shall have no liability for the consequences of use of such information.

Right to make changes — NXP Semiconductors reserves the right to make changes to information published in this document, including without limitation specifications and product descriptions, at any time and without notice. This document supersedes and replaces all information supplied prior to the publication hereof.

Suitability for use — NXP Semiconductors products are not designed, authorized or warranted to be suitable for use in medical, military, aircraft, space or life support equipment, nor in applications where failure or malfunction of an NXP Semiconductors product can reasonably be expected to result in personal injury, death or severe property or environmental

damage. NXP Semiconductors accepts no liability for inclusion and/or use of NXP Semiconductors products in such equipment or applications and therefore such inclusion and/or use is at the customer's own risk.

Applications — Applications that are described herein for any of these products are for illustrative purposes only. NXP Semiconductors makes no representation or warranty that such applications will be suitable for the specified use without further testing or modification.

Limiting values — Stress above one or more limiting values (as defined in the Absolute Maximum Ratings System of IEC 60134) may cause permanent damage to the device. Limiting values are stress ratings only and operation of the device at these or any other conditions above those given in the Characteristics sections of this document is not implied. Exposure to limiting values for extended periods may affect device reliability.

Terms and conditions of sale — NXP Semiconductors products are sold subject to the general terms and conditions of commercial sale, as published at <http://www.nxp.com/profile/terms>, including those pertaining to warranty, intellectual property rights infringement and limitation of liability, unless explicitly otherwise agreed to in writing by NXP Semiconductors. In case of any inconsistency or conflict between information in this document and such terms and conditions, the latter will prevail.

No offer to sell or license — Nothing in this document may be interpreted or construed as an offer to sell products that is open for acceptance or the grant, conveyance or implication of any license under any copyrights, patents or other industrial or intellectual property rights.

Export control — This document as well as the item(s) described herein may be subject to export control regulations. Export might require a prior authorization from national authorities.

Quick reference data — The Quick reference data is an extract of the product data given in the Limiting values and Characteristics sections of this document, and as such is not complete, exhaustive or legally binding.

11.4 Trademarks

Notice: All referenced brands, product names, service names and trademarks are the property of their respective owners.

12. Contact information

For more information, please visit: <http://www.nxp.com>

For sales office addresses, please send an email to: salesaddresses@nxp.com

13. Contents

1 Product profile 1

1.1 General description 1

1.2 Features 1

1.3 Applications 1

1.4 Quick reference data 1

2 Pinning information 2

3 Ordering information 3

4 Marking 3

5 Limiting values 4

6 Thermal characteristics 5

7 Characteristics 5

8 Package outline 7

9 Packing information 9

10 Revision history 10

11 Legal information 11

11.1 Data sheet status 11

11.2 Definitions 11

11.3 Disclaimers 11

11.4 Trademarks 11

12 Contact information 11

13 Contents 12

Please be aware that important notices concerning this document and the product(s) described herein, have been included in section 'Legal information'.



© NXP B.V. 2009.

All rights reserved.

For more information, please visit: <http://www.nxp.com>

For sales office addresses, please send an email to: salesaddresses@nxp.com

Date of release: 3 September 2009

Document identifier: PDTA124X_SER_8