



PCL/PCLH series

3A, 5A, 10A, 15A General Purpose Miniature Relay

Factory Automation, Process Controls,
Electrical Panels, etc.

UL File No. E58304

CSA File No. LR48471

Users should thoroughly review the technical data before selecting a product part number. It is recommended that user also seek out the pertinent approvals files of the agencies/laboratories and review them to ensure the product meets the requirements for a given application.

Features

- Small size, 3A, 5A, 10A and 15A switching capacity.
- Meets UL and CSA requirements.
- 1 pole, 2 poles and 4 poles contact arrangements.
- AC and DC coils with UL Class F (155°C) coil insulation system standard.
- Optional flange mount case.
- Plug-in terminals or PCB terminals.

Contact Data @ 20°C

Arrangements: 1 Form A (SPST-NO), 1 Form C (SPDT),
2 Form A (DPST-NO), 2 Form C (DPDT),
4 Form A (4PST-NO), 4 Form C (4PDT).

Material: Ag, Ag Alloy.

Max. Switching Rate: 300ops./min. (Mechanical).
30ops./min. (Electrical).

Expected Mechanical Life: 100 million operations (no load).

Expected Electrical Life: 100,000 operations (rated load).

Minimum Load: 100mA @ 5VDC.

Initial Contact Resistance: 50milliohms @ DC6V,1A.

Contact Ratings

Ratings: PCL-4 3A @ AC250V/DC24V resistive.
PCL-2 5A @ AC250V/DC24V resistive.
PCLH-2 15A @ AC120V resistive.
10A @ AC250V/DC24V resistive.
PCLH-1 15A @ AC250V/DC24V resistive.

Max. Switched Current: PCL-4 3A.
PCL-2 5A.
PCLH-2 15A.
PCLH-1 15A.

Max. Switched Power: PCL-4 660VA, 72W.
PCL-2 1,100VA, 120W.
PCLH-2 3,168VA, 240W.
PCLH-1 3,300VA, 360W.

Initial Dielectric Strength

Between Open Contacts: 1,000VAC 1minute.

Between Adjacent Contact Terminals: 1,500VAC 1minute.

Between Contacts and Coil: 2,000VAC 1minute.

Surge Voltage (Coil-Contact): 3,000V(1.2/50µs).

Initial Insulation Resistance

Between Open Contacts: 1,000Mohms @ 500VDC.

Between Adjacent Contact Terminals: 1,000Mohms @ 500VDC.

Between Contacts and Coil: 1,000Mohms @ 500VDC.

Coil Data

Voltage: AC 6 - 240V.
DC 6 - 110V.

Nominal Power: AC abt. 1.4VA/1.2VA (50Hz/60Hz).
DC abt. 0.9W.

Coil Temperature Rise: AC 60°C max.
DC 50°C max.

Max. Coil Power: 110% of nominal voltage.

Coil Data @ 20°C

PCL AC Coil				
Rated Coil Voltage (VAC)	Coil Resistance (ohms)±10%	Must Operate Voltage (VAC)	Must Release Voltage (VAC)	Nominal Coil Power (VA)
6	10	80% max.	30% min.	abt. 1.4
12	40			
24	160			
48	600			
100	2,800			
110/120	3,400			
200	11,000			
220/240	13,600			
PCL DC Coil				
Rated Coil Voltage (VDC)	Coil Resistance (ohms)±10%	Must Operate Voltage (VDC)	Must Release Voltage (VDC)	Nominal Coil Power (W)
6	40	80% max.	10% min.	abt. 0.9
12	160			
24	650			
48	2,600			
100/110	11,000			abt. 1.1

Operate Data @ 20°C

Must Operate Voltage: AC 80% of nominal voltage or less.
DC 80% of nominal voltage or less.

Must Release Voltage: AC 30% of nominal voltage or more.
DC 10% of nominal voltage or more.

Operate Time: AC 20ms max.
DC 15ms max.

Release Time: AC 20ms max.
DC 8ms max.

Environmental Data

Temperature Range:

Operating: -10°C to +55°C.

Humidity: 45 to 85%. (Non-condensing).

Vibration, Operational: 10 to 55Hz 1.0mm double amplitude.

Mechanical: 10 to 55Hz 1.0mm double amplitude.

Shock, Operational: 100m/s² (abt. 10G).

Mechanical: 1,000m/s² (abt. 100G).

Mechanical Data

Termination: Plug-in, PCB.

Enclosure: Snap-on cover.

Weight: 1.26 oz (32g) approximately.

Ordering Information

		Typical Part Number		PCL	-2	02A	1	S	,000
1. Basic Series:									
PCL = 3A, 5A type		PCLH = 10A,15A type							
2. Number of Poles:									
1 = 1 pole (PCLH only)		2 = 2 pole		4 = 4 pole (PCL only)					
3. Coil Voltage:									
01A=6VAC	02A=12VAC	03A=24VAC	04A=48VAC						
05A=100VAC	06A=110/120VAC	07A=200VAC	08A=220/240VAC						
01D=6VDC	02D=12VDC	03D=24VDC	04D=48VDC	05D=100/110VDC					
4. Contact Material:									
Blank = Ag (only available on 4 pole model)				1 = Ag Alloy (available with all versions)					
5. Contact Arrangement:									
Blank = Form C		M = Form A							
6. Case Type:									
S = Standard (Smoke color)		F = Flange mount (Smoke color)							
7. Terminal Type:									
Blank = Plug-in		P = PCB							
8. Indicator Lamp:									
Blank = None		L = Indicator Lamp							
9. Option:									
,000 = Standard model		Other suffix = Custom model.							

Our authorized distributors are more likely to stock the following items for immediate delivery.

- PCLH-202A1S,000
- PCLH-203A1S,000
- PCLH-206A1S,000
- PCLH-208A1S,000
- PCLH-202D1S,000
- PCLH-203D1S,000
- PCLH-204D1S,000
- PCLH-205D1S,000
- PCLH-206A1SP,000
- PCLH-202D1SP,000
- PCLH-203D1SP,000
- PCLH-205D1SP,000

Outline Dimensions

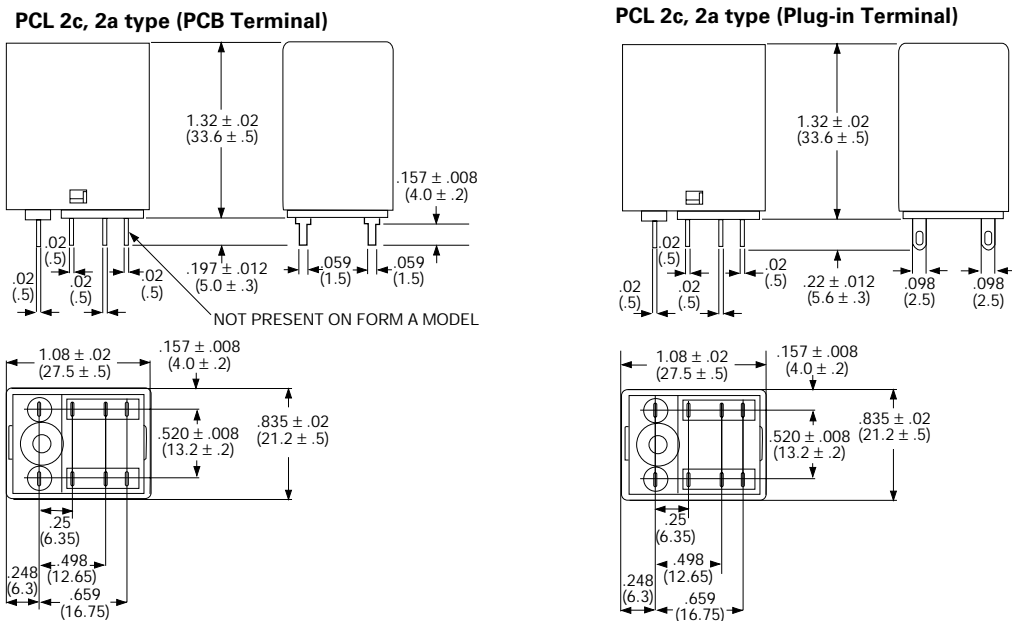

Outline Dimensions (continued)

PCL 4c, 4a type (PCB Terminal)

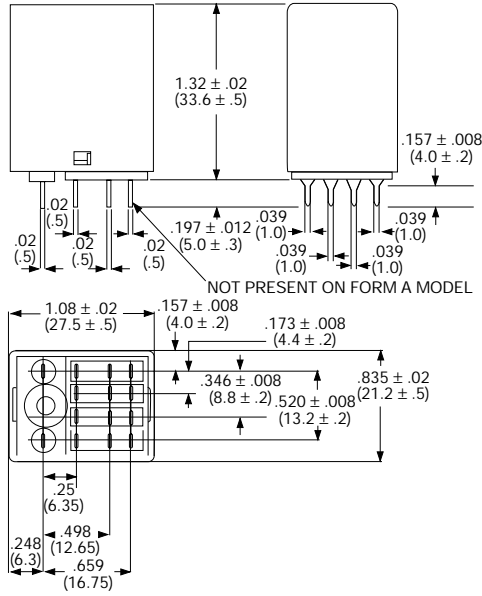

PCL 4c, 4a type (Plug-in Terminal)

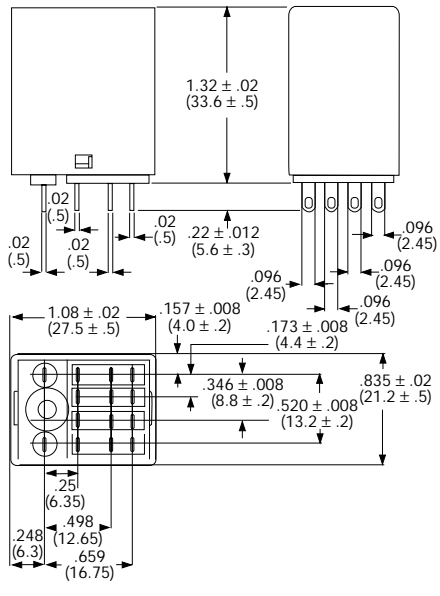

PCLH type (PCB Terminal)

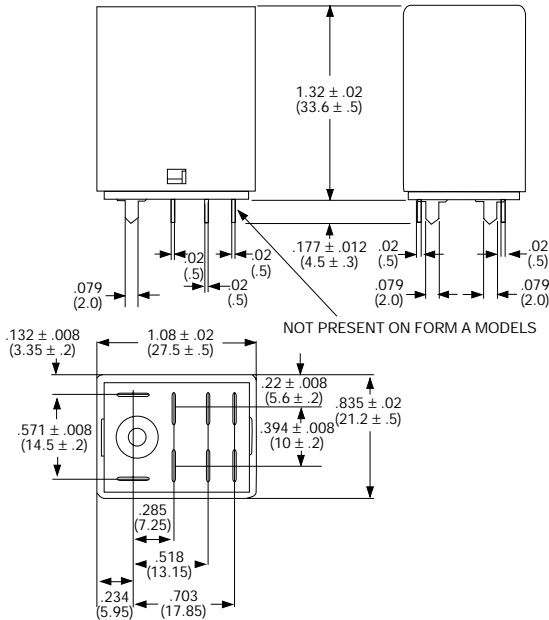

PCLH type (Plug-in Terminal)

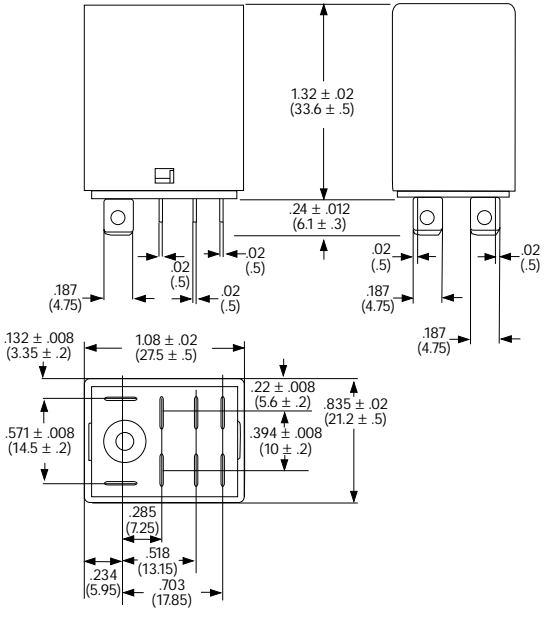

PCLH type (Flange Mount Case)

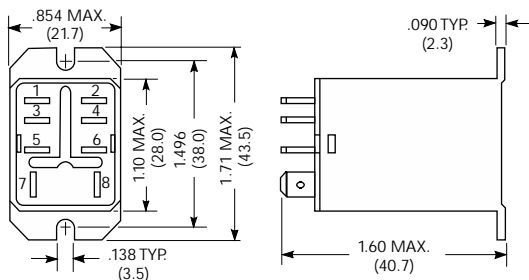

Dimensions are shown for reference purposes only.

Dimensions are in inches over (millimeters) unless otherwise specified.

Specifications and availability subject to change.

www.tycoelectronics.com
Technical support:
Refer to inside back cover.

Wiring Diagrams (Bottom Views)

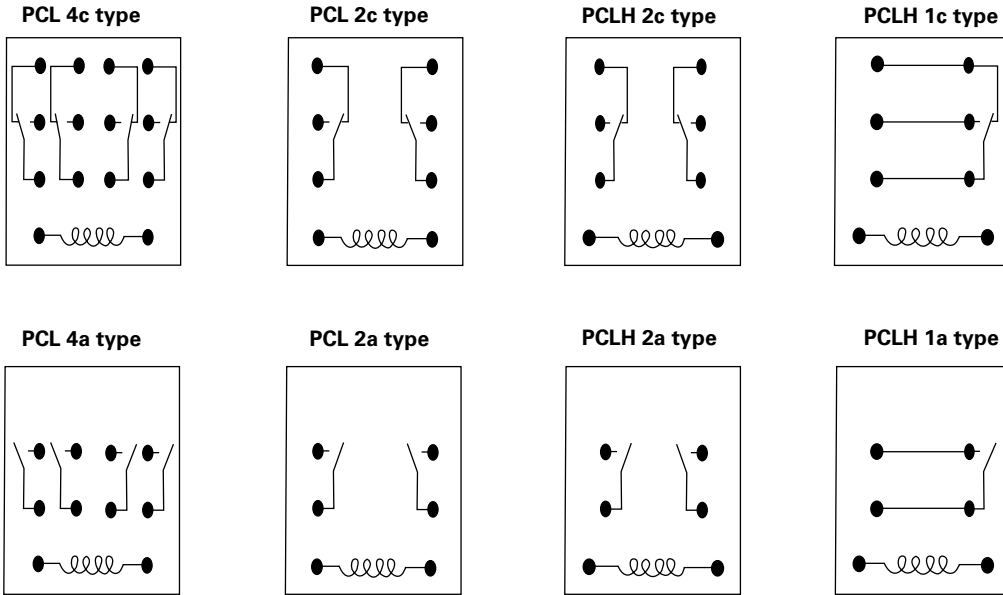

PC Board Layouts (Bottom Views)

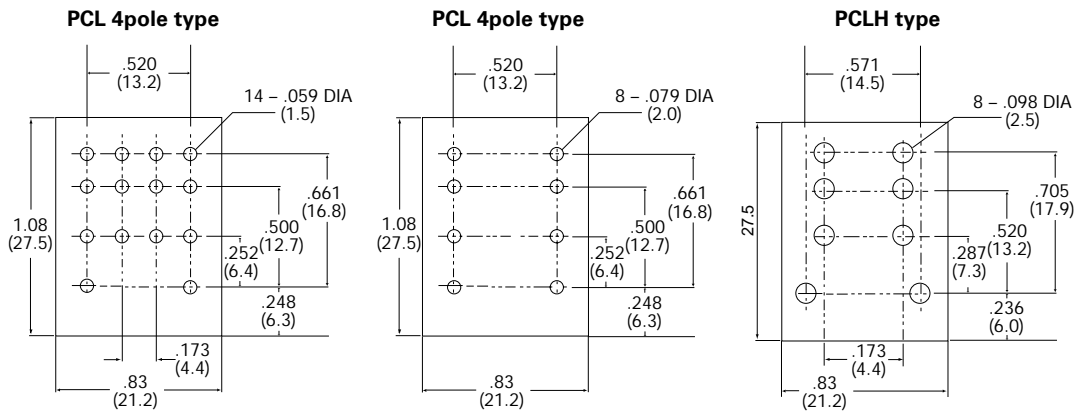

Reference Data

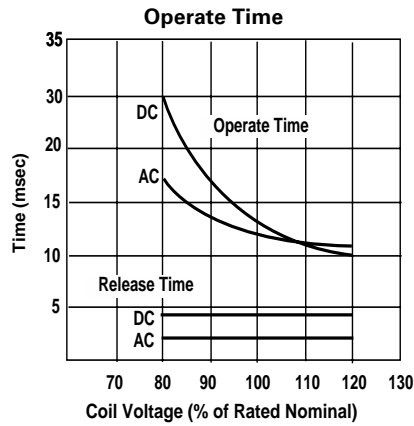
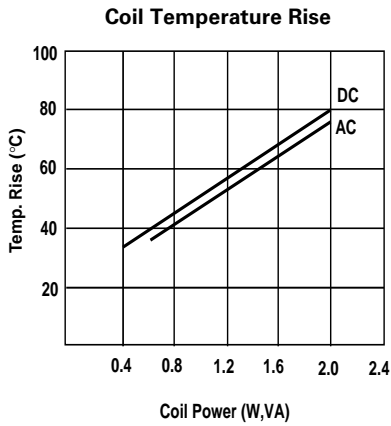

Sockets

For PCL socket information refer to KH series sockets (page 712).
For PCLH socket information refer to K10 series sockets (page 722).