

Non-fusible & fusible disconnect switch Accessories

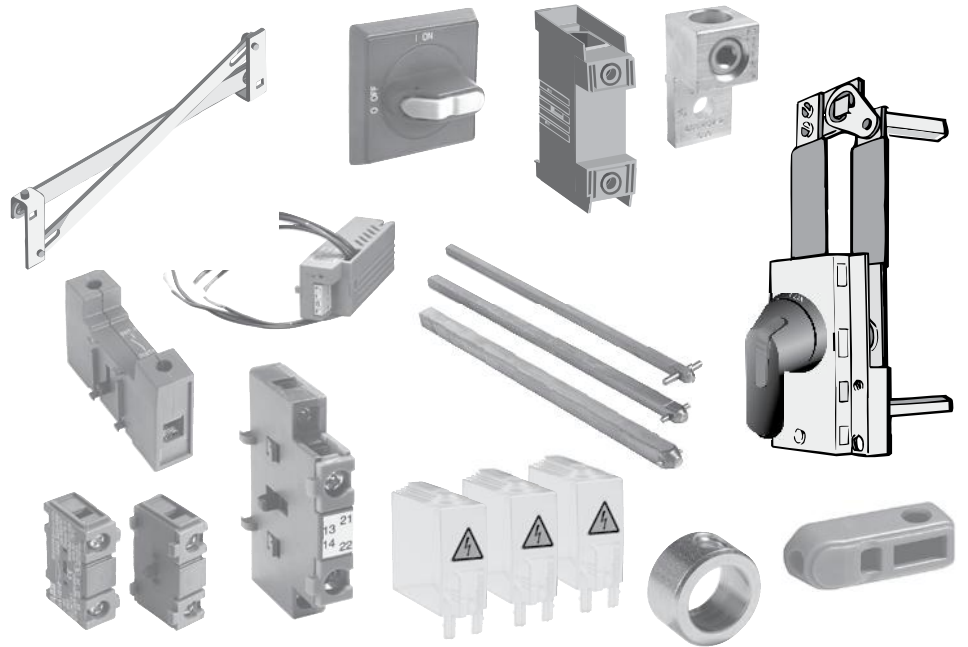

Disconnect switch accessories
Non-fusible & fusible



Standard handles & shafts ① ②



OHBS2AJ1



OHB_J6



OHY_J6



YASDA-8

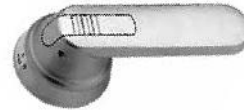

OHM125L12



OHB4

Recommended handles & shafts

Amperes	Shaft diameter	Recommended standard pistol handle length	Maximum recommended shaft length
16 - 100	6x6 mm - .24 x .24"	45 - 65 mm	290 mm
200	6x6 mm - .24 x .24"	65 - 80 mm	290 mm
400 - 1200	12x12 mm - .47 x .47"	125 - 274 mm	595 mm
1600 - 3150	12x12 mm - .47 x .47"	175 - 330 mm	595 mm

Selector handles — for use with .24 x .24" (6mm) OXS6X shafts

UL/NEMA Type	IEC type	Color	Marking	Defeatable	Padlockable	Weight (lbs)	Catalog number
1	IP54	Black	O/I & Off/On	—	—	0.09	OHBS1AH1 ③
				—	Yes	0.12	OHBS3AH1 ③
1, 3R, 12	IP65	Black	O/I & Off/On	—	Yes	0.16	OHBS2AJ1 ③
				Yes	Yes	0.16	OHBS2AJ ③

Pistol handles — for use with .24 x .24" (6mm) OXP6X shafts

UL/NEMA Type	IEC type	Color	Marking	Length in/mm	Defeatable	Padlockable	Weight (lbs)	Catalog number
1, 3R, 12	IP65	Black	O/I & Off/On	2.6/65	Yes	Yes	0.29	OHB65J6
			Off/On/Test	2.6/65	Yes	Yes	0.29	OHB65J6T ④
			O/I & Off/On	3.1/80	Yes	Yes	0.30	OHB80J6
1, 3R, 12, 4, 4X	IP66	Black	O/I & Off/On	2.6/65	Yes	Yes	0.29	OHB65L6
				3.1/80	Yes	Yes	0.30	OHB80L6
1, 3R, 12, 4, 4X	IP66	316L Stainless steel	O/I & Off/On	2.6/65	Yes	Yes	1.60	OHM65L6
1, 3R, 12	IP65	Black w/ 316 stainless hasp	O/I & Off/On	2.6/65	Yes	Yes	0.31	OHB65J6EH
1, 3R, 12, 4, 4X	IP66	Black w/ 316 stainless hasp	O/I & Off/On	2.6/65	Yes	Yes	0.31	OHB65L6EH

Pistol handles — for use with .47 x .47" (12mm) OXP12X shafts

UL/NEMA Type	IEC type	Color	Marking	Length in/mm	Defeatable	Padlockable	Weight (lbs)	Catalog number
1, 3R, 12	IP65	Black	O/I & Off/On	4.9/125	Yes	Yes	0.39	OHB125J12
				5.7/145	Yes	Yes	0.39	OHB145J12
				6.9/175	Yes	Yes	0.41	OHB175J12
				7.9/200	Yes	Yes	0.88	OHB200J12P
				10.8/274	Yes	Yes	1.19	OHB274J12
				13/330	Yes	Yes	1.28	OHB330J12
1, 3R, 12, 4, 4X	IP66	Black	O/I & Off/On	5.7/145	Yes	Yes	0.39	OHB145L12
				6.9/175	Yes	Yes	0.41	OHB175L12
				7.9/200	Yes	Yes	0.88	OHB200L12P
				10.8/274	Yes	Yes	1.19	OHB274L12
				13/330	Yes	Yes	1.28	OHB330L12
				1, 3R, 12, 4, 4X	IP65	Metal	Off/On	8.7/220
1, 3R, 12, 4, 4X	IP66	316L Stainless Steel	O/I & Off/On	4.9/125	Yes	Yes	1.7	OHM125L12
				6.9/175	Yes	Yes	1.8	OHM175L12
				10.8/275	Yes	Yes	2.1	OHM275L12
				7.9/200	Yes	Yes	0.88	OHM200L12P
1, 3R, 12	IP65	Black w/ 316 stainless hasp	O/I & Off/On	4.9/125	Yes	Yes	0.44	OHB125J12EH
				6.9/175	Yes	Yes	0.76	OHB175J12EH
1, 3R, 12, 4, 4X	IP66	Black w/ 316 stainless hasp	O/I & Off/On	4.9/125	Yes	Yes	0.44	OHB125L12EH
				6.9/175	Yes	Yes	0.76	OHB175L12EH

① Red/Yellow handles are available by substituting the OHB prefix with OHY.

② All handles are plastic unless otherwise noted as metal or stainless steel.

③ Not recommended for use on OT30/60/100.

④ The OS30 switch has a TEST position, accessed by rotating the mechanism 45 degrees counterclockwise from the OFF position. In the TEST position, optional auxiliary contacts, OA4B1C, are actuated but the main switch contacts are not.

Standard handles & shafts ②

Disconnect
switches
Accessories

Direct mount handle for non-fusible switches

Description	For use on	Color	Padlockable	Shaft through handle	Weight	Shaft catalog number	Switch catalog number
Mounts directly on switch. No shaft necessary	OT16-40	Black	Yes	Yes	0.05		OHBS12 ③ CXBY68998
	OT63-80	Black	Yes	Yes	0.05		OHBS2③ CXBY68998
	OT30/60/100		No Yes				
Up to 3 padlocks in OFF-position, includes shaft and mechanism	OT200	Black	Yes	No	0.22		OTV250EK
	OT400	Black	Yes	Yes	0.44		OTV400EK
	OT600	Black	Yes	Yes	0.66		OTV800EK
	OT800	Black	Yes	Yes	0.30		OTV1000EK
	OT1200	Black	Yes	Yes	0.30		OTV1000EK
Mounts on shaft	OETL-NF1600-OETL-NF3150	Metal	No	Yes	0.80		YASDA-34

Direct mount handle for fusible switches

For use on	Description	Marking	Color	Padlockable	Weight	Catalog number
OS30	No shaft required	O/I/Test	Black	Yes	0.10	OHBS5
OS60 - OS200	No shaft required	O/I	Black	Yes	0.30	OSV200BK
OS400	No shaft required	O/I	Black	Yes	0.30	OSV400BK
OS600	No shaft required	O/I	Black	Yes	0.30	OSV800BK
OS400-600, OES800	Mounts on 12mm shaft	—	Metal	No	0.78	YASDA-33

3 Position selector handles for double throw switches

UL/NEMA Type	IEC Type	Markings	Color	Defeatable	Padlockable	Weight (Lbs.)	Catalog number
1, 3R, 12	IP65	I/O/II, ON/OFF/ON	Black	Yes	Yes	0.16	OHBS2AJE011

3 Position pistol handles for double throw switches

UL/NEMA Type	IEC Type	Markings	Color	Defeatable	Padlockable	Weight (Lbs.)	Catalog number	Catalog number
1, 3R, 12	IP65	I/O/II, ON/OFF/ON	Black	Yes	Yes	0.29	OHB65J6E011	OHB145J12E011
1, 3R, 12, 4, 4X	IP66		Black	Yes	Yes	0.29	OHB65L6E011	OHB145L12E011
1, 3R, 12	IP65	I/O/II, ON/OFF/ON	Black	Yes	Yes	0.3	OHB80J6E011	OHB175J12E011
1, 3R, 12, 4, 4X	IP66		Black	Yes	Yes	0.3	OHB80L6E011	OHB175L12E011

Selector handles for door mounted switches ①

UL/NEMA Type	IEC Type	Color	Defeatable	Padlockable	Weight (lbs)	Catalog number
Snap-on mounting - for use on OT16FT3 - OT40FT3						
1	IP54	Black	—	—	0.10	OHBS1PH
1	IP54	Black	—	Yes	0.13	OHBS3PH
1, 3R, 12	IP65	Black	—	Yes	0.17	OHBS2PJ
Screw mounting - for use on OT16FT3 - OT100FT3. For OT30, OT60, and OT100 use OH_ _2_ only						
1	IP54	Black	—	—	0.11	OHBS1RH
1	IP54	Black	—	Yes	0.14	OHBS3RH
1, 3R, 12	IP65	Black	—	Yes	0.18	OHBS2RJ

- ① Red/Yellow handles are available by substituting the OHB prefix with OHY.
- ② All handles are plastic unless otherwise noted as metal or stainless steel.
- ③ Suitable for 3 & 4 pole versions only. Not for use with 6 or 8 pole or double throw configurations.

Standard handles & shafts

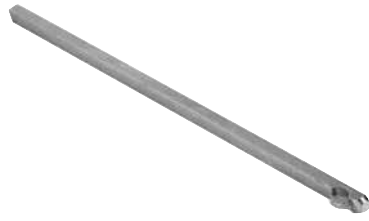

OXS6X_



OXP6X
OXP12X_

Shafts for use with selector handles – .24 x .24" (6x6 mm)

Shaft length (in/mm)	Maximum Mounting Depth (inches) ①					Weight	Catalog number
	OT16F3, OT25F3, OT40F3		OT63F3, OT80F3		OS30 ②		
	OH_1_ & OH_3_	OH_2_	OH_1_ & OH_3_	OH_2_			
3.3/85	5.0	4.3	5.6	5.0	–	0.07	OXS6X85
4.1/105	5.8	5.1	6.4	5.8	–	0.07	OXS6X105
4.7/120	6.4	5.8	7.0	6.4	–	0.08	OXS6X120
5.1/130	6.7	6.1	7.4	6.8	5.6	0.08	OXS6X130
7.1/180	8.7	8.1	9.4	8.7	6.1	0.11	OXS6X180
9.8/250	11.5	10.8	12.1	11.5	10.3	0.13	OXS6X250
13/330	14.6	14.0	15.3	14.7	13.4	0.17	OXS6X330

Shafts for use with pistol handles – .24 x .24" (6x6 mm)

Shaft length (in/mm)	Maximum Mounting Depth (inches)								Weight	Catalog number
	OT16F3 - OT40F3	OT63F3 - OT80F3	OT30F3/60F3/100F3	OT200	OS30	OS60	OS100	OS200		
5.2/130	5.9	6.4	6.7	6.5	–	–	–	–	0.08	OXP6X130
5.9/150	6.7	7.4	7.0	7.2	8.9	9.7	9.8	9.9	0.09	OXP6X150
8.3/210	9.1	9.7	9.8	9.6	9.7	12.1	12.2	13.0	0.13	OXP6X210
11.4/290	12.2	12.8	12.9	12.7	13.4	15.2	15.3	–	0.18	OXP6X290
14.2/360	14.9	13.8	15.6	15.5	18.7	12.9	18.0	–	0.23	OXP6X360
16.9/430	17.6	18.3	18.3	18.2	22.6	20.6	20.7	–	0.27	OXP6X430

Shafts for use with pistol handles – .47 x .47" (12x12 mm)

Shaft length (in/mm)	Maximum Mounting Depth (inches)						Weight	Catalog number
	OT400	OT600	OT800 - OT1200	OETL-NF1600 - OETL-NF3150	OS400	OS600 - OS1200		
11.0/280	13.3	14.6	14.5	–	13.8	14.9	0.77	OXP12X280
12.8/325	15.0	16.4	16.3	20.9	15.6	16.7	0.90	OXP12X325
15.6/395	20.5	19.1	19.1	23.6	18.3	19.4	1.10	OXP12X395
18.3/465	21.9	21.8	21.9	26.3	21.0	22.1	1.32	OXP12X465
21.1/535	22.8	24.6	24.6	29.1	23.8	24.8	1.54	OXP12X535

① Mounting depth is distance from the outside of the door to the disconnect switch mounting plate. Shaft can be cut to desired length.
② Selector handles and shafts are not recommended for use with fusible switches over 30A.

Auxiliary contacts

Disconnect switches
Accessories

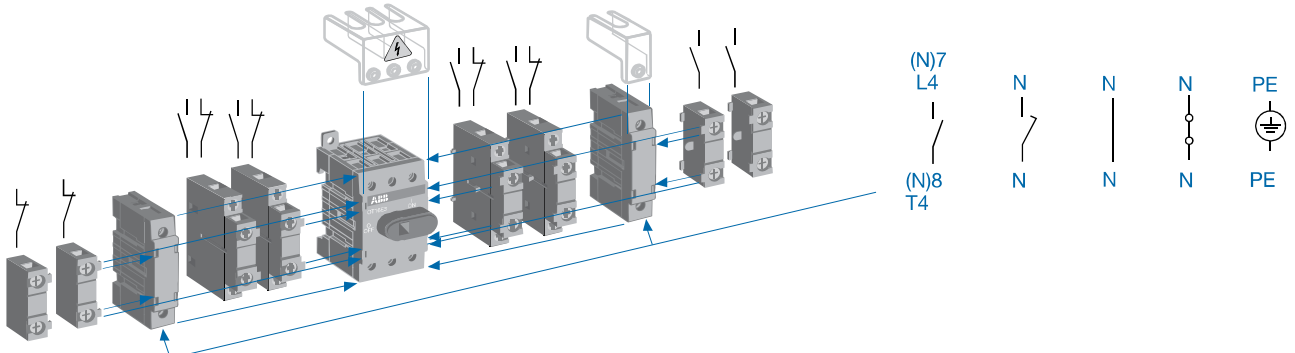

Auxiliary contacts — snap-on mounting ①

Description	For Use On	Weight	AC Thermal amp rating	AC rated voltage	Catalog number
Form C 1 N.O. & 1 N.C.	OS30 ②	0.04	6	250	OA4B1C
1 N.O.	OT16-100, OT200-1200 OS30-OS1200	0.07	10	600	OA1G10
1 N.C.	OT16-100	0.07	10	600	OA1G01
	OT200-1200 OS30-OS1200	0.07	10	600	OA3G01
1 N.O. & 1 N.C.	OT16-100	0.07	10	600	OA2G11
Module for auxiliary contacts	OS30	0.09	—	—	OSZA
	OT200-1200 OS200-OS1200	0.1	—	—	OEA28 ③



OEA28

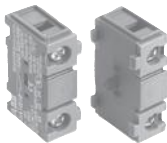

OA1G_



OA2G11

Auxiliary contacts — front mounting ③

Description	For Use On	Weight	AC Thermal amp rating	AC rated voltage	Catalog number
1 N.O. + 1 N.C.	OETL-NF1600 through	0.2	10	600	OZXK-1
2 N.O. + 2 N.C.		0.26	10	600	OZXK-2
4 N.O. + 4 N.C.		0.4	10	600	OZXK-3
2 N.O.	OETL-NF3150	0.18	10	600	OZXK-4
4 N.O.		0.25	10	600	OZXK-5
8 N.O.		0.4	10	600	OZXK-6

Auxiliary contacts — snap-on mounting for double throw

Description	For Use On	Weight (Lbs.)	AC Thermal amp rating	AC rated voltage	Catalog number
1 N.O.	OT16-100_C	0.7	10	600	OA7G10
1 N.C.	OT16-800_C	0.7	10	600	OA3G01
1 N.O.	OT200-800_C	0.7	10	600	OA1G10

Mounting & installation considerations

Non-Fusible

OT16-100	OA1G10 (1 N.O.) mounts on right side of switch only OA1G01 (1 N.C.) mounts on left side of switch only OA2G11 (1 N.O. & 1 N.C.) mounts on left of right side of switch Maximum two contacts on each side of switch
OT200-1200	Maximum 8 auxiliary contact blocks with the OEA28 module Maximum 4 auxiliary contact blocks mounting under the mechanisms

Fusible

OS30	Form C contacts mount directly to switch Maximum two Form C contacts OA1G10 (1 N.O.) + OA3G01 (1 N.C.) require mounting base Maximum 6 OA1G10 + OA3G01 contacts with mounting base OSZA
OS60-1200	Mounting to left side of switch with OEA28 module: Maximum 8 contact blocks Mounting under mechanism cover: Maximum 4 contact blocks

① UL file #E83510

② Not suitable for use on cable operated flange version of OS100

③ UL File #E5707

④ Maximum 8 contact blocks (N.O. or N.C.) with the OEA28 module.

Terminal lugs

Terminal lugs ①

For Use On	Wire Size	Wire Type	Lugs/Kit	Weight (lbs)	Catalog number
OS100	#14-2/0	Cu/Al	6	0.50	OZXA-24 ②
OT200/OS200	#4 - 300 kcmil	Cu/Al	6	0.50	OZXA-200
	#4 - 300 kcmil		3	0.25	OZXA-200/3
	(6) 14-6 AWG		3	0.25	OZXA-206T ④
	(6) 14-6 AWG		3	0.25	OZXA-206S ④
OT/OS400	#2 - 600 kcmil	Cu/Al	6	0.50	OZXA-400
			3	0.25	OZXA-400/3P
			6	0.50	OZXA-402
			3	0.50	OZXA-406
OT600 , OS600 - OS800	(2) #2 - 600 kcmil	Cu/Al	6	0.50	OZXA-800
	(2) #2 - 600 kcmil		3	0.50	OZXA-800/3
OT800, OT1200 & OS1200	(4) #2 - 600 kcmil	Cu/Al	6	6.90	OZXA-1200
	(4) #2 - 600 kcmil		3	3.45	OZXA-1200/3
OETL-NF1600	(4) #2 - 600 kcmil	Cu/Al	6	10.44	OZXA-28
	(4) #2 - 600 kcmil		3	5.22	OZXA-28/3
	(8) 2/0 + (2) #2 - 600 kcmil ③		3	10.44	OZXA-32
OETL-NF2000-3150	(8) #2 - 600 kcmil	Cu/Al	12	20.88	OZXA-28/2

Terminal lug kits for double throw switches

For Use On	Wire Size	Wire Type	Lugs/Kit	Weight (Lbs)	Catalog number
OT200_C	#4 - 300kcmil #4 - 300kcmil	Cu/Al	9	0.5	OZXA-200/9
			12	0.25	OZXA-200/12
OT400_C	#2 - 600kcmil #2 - 600kcmil	Cu/Al	9	0.5	OZXA-400/9
			12	0.25	OZXA-400/12
OT600_C	(2) #2 - 600kcmil (2) #2 - 600kcmil	Cu/Al	9	0.5	OZXA-800/9
			12	0.5	OZXA-800/12
OT800_C	(4) #2 - 600 kcmil (2) #2 - 600 kcmil Cu/Al	Cu/Al	9	0.5	OZXA-1200/9
			12	0.5	OZXA-1200/12



OZXA-400



OZXA-27



OZXA-30



OZXA-32



OZXA-175/400



OZXA-24



OZXA-27

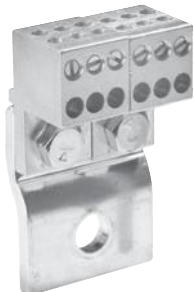

OZXA-175/400

① Lugs are integral to the switch for 16-125A. No separate lug kit accessory is required.
 ② Not suitable for use on cable operated flange version OS100.
 ③ A load side distribution lug eliminates the need to purchase, install and wire a separate distribution block.
 ④ Comes with OZXA-175 terminal lugs and shrouds.

Terminal shrouds



OTS250G1L/3

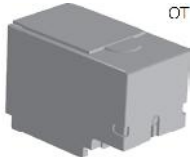

OTS250G1S/3

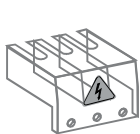

OTS40T3
OTS80T3
OTS125T3

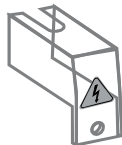

OTS40T1
OTS80T1
OTS125T1



OSS160T3



OSS200G1S/3



OSS200G1L/3

Terminal shrouds for non-fusible

Description	For Use On	Weight	Catalog number
3 pole includes one shroud for line or load side	OT16-OT40 ②	0.02	OTS40T3
	OT63-OT80 ②	0.02	OTS63T3
	OT30-OT100 ②	0.02	OTS125T3
4th pole includes one shroud for line or load side	OTPS40FPN1 ②	0.03	OTS40T1
	OTPS80FP ②	0.03	OTS80T1
	OTPS125FP ②	0.03	OTS125T1
3 pole long type shrouds	OT200	0.12	OTS250G1L/3
3 pole short type shrouds		0.13	OTS250G1S/3
4 pole long type shrouds		0.26	OTS250G1L/4
4 pole short type shrouds		3.18	OTS250G1S/4
3 pole includes one shroud for line or load side ①	OT400	0.33	OTS403
	OT600	0.33	OTS603
3 pole includes one shroud for line or load side ①	OT800	0.88	OTS803
	OT1200	1.2	OTS1203

Terminal shrouds for fusible

Description	For Use On	Weight (Lbs.)	Catalog number
Terminal shroud for one pole	OS100	0.04	OSS160GG1L/3
Terminal shroud for 3 poles	OS100	0.04	OSS160GG1S/3
3 pole long type shrouds	OS200	0.20	OSS200G1L/3
3 pole short type shrouds	OS200	0.13	OSS200G1S/3
4 Pole long type shrouds	OS200	0.26	OSS200G1L/4
4 pole Short type shrouds	OS200	0.18	OSS200G1S/4
3 Pole includes one shroud for line or load side ①	OS400	0.13	OSS403
	OS600	0.11	OSS603
3 pole short type shrouds	OS800	0.47	OSS800G1S/3
3 pole long type shrouds		1.54	OSS800G1L/3
4 pole short type shrouds		0.62	OSS800G1S/4
4 pole long type shrouds		1.54	OSS800G1L/4
3 pole short type shrouds	OS1200	0.88	OSS1250G1S/3
3 pole long type shrouds		2.12	OSS1250G1L/3
4 pole short type shrouds		1.15	OSS1250G1S/4
4 pole long type shrouds		2.2	OSS1250G1L/4

① For 4 pole shrouds, please consult factory.

② ABB OT16 - OT100 switches are IP20 touchsafe as standard. Terminal shrouds provide an extra degree of protection.

Additional poles

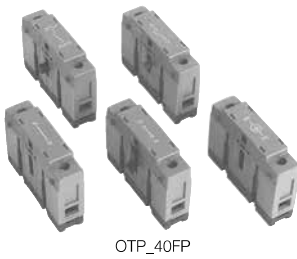

OTP_40FP

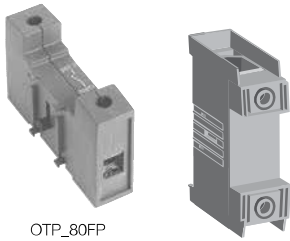

OTP_80FP

OTP_125FP

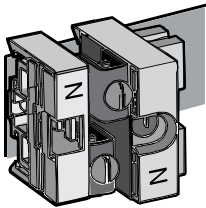

OESA-ZX171

Additional poles for non-fusible ①

Power poles - Only one power pole per switch: mounts on left or right side of switch. (OTPS40FPN1 mounts to left side only)

Description	For use on	Weight	AC Thermal amp rating	AC rated voltage	Catalog number
 Fourth Pole	OT16-OT40	0.07	40	600	OTPS40FPN1 OTPS60FP OTPS80FP OTPS125FP
	OT30-OT60	0.13	60		
	OT63-OT80	0.13	80		
	OT100	0.31	100		
 Late-break/ early-make	OT16-OT40	0.07	40	600	OTPL40FP OTPL60FP OTPL80FP OTPL125FP
	OT30-OT60	0.13	60		
	OT63-OT80	0.13	80		
	OT100	0.31	100		

Terminal poles - Switch accepts one terminal pole per side: mounts on left or right side of switch

Description	For use on	Weight	AC Thermal amp rating	AC rated voltage	Catalog number
 Solid neutral	OT16-OT40	0.07	40	600	OTPN40FP OTPN60FD OTPN80FP OTPN125FP
	OT30-OT60	0.13	60		
	OT63-OT80	0.13	80		
	OT30-OT100	0.31	100		
 Detachable Neutral	OT16-OT40	0.07	40	600	OTPD40FP OTPD60FP OTPD80FP OTPD125FP
	OT30-OT60	0.13	60		
	OT63-OT80	0.13	80		
	OT100	0.31	60		
 Ground Terminal	OT16-OT40	0.07	40	600	OTPE40FP OTPE60FP OTPE80FP OTPE125FP
	OT30-OT60	0.13	60		
	OT63-OT80	0.13	80		
	OT100	0.31	100		

Additional poles for fusible

Description	For use on	Weight (Lbs.)	AC Thermal amp rating	AC rated voltage	Catalog number
Detachable neutral mounts on side of switch or DIN rail	OS30	0.45	30	600	OESA-ZX171
	OS60	0.13	63	600	OSZ1
	OS100	0.31	125	600	OSZ2

① Switches accept only one power pole or one terminal pole per side. Only one power pole per switch.

Fuse monitors & carriers



OFM_



OSC60J_



CXBY68362

Fuse monitors

Blown fuse indicators/monitors

For Use With	Rated Voltage	Weight (lbs)	Catalog number
OS30-1200	100-240 380-600	0.31 0.31	OFM240 OFM600

Suitable for 1 or 3 phase circuits. Includes 1 N.O. and 1 N.C. auxiliary contacts and red & green LED lights for indication.

Fuse Monitor Mounting Accessories

For Use With	Crimp Terminal size (mm)	Catalog number
OS30-200	2.8-0.8	OFMZK2
OS400-1200 Includes 6 crimp terminals	6.3-0.8	OFMZK4

Fuse carriers/covers

Description	For Use on	Catalog number
CC fuse carrier (Qty. 1)	OS30AFCC_	OESAZD48
J fuse carrier (Qty. 1)	OS30AFJ_	OESAZD28
Solid link carrier (Qty. 1)	OS30_	OESAZD55

Shorting bars for fusible switches

Description	For Use On	AC thermal amp rating	AC rated voltage	Catalog number
Dummy Fuse	OS60	60	600	OESA-ZD54
Solid links: metal strap	OS100	100	600	OESA-ZS36
	OS200	400	600	OESA-ZK98

Miscellaneous accessories Replacement parts

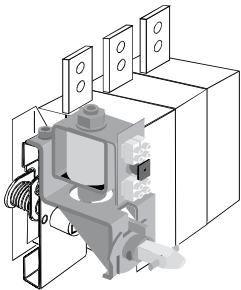

OETL-ZT80_

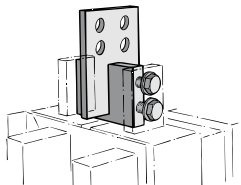

OETL-ZX115

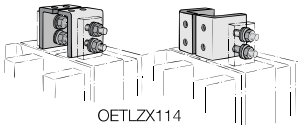

OETLZX114



OTZS2

Miscellaneous accessories

Shaft accessories

Accessory Type	Description	For Use On	Weight	Catalog number
Shaft Adapter	Adapts one end of a 6mm shaft to 12mm (use with shaft extension coupler)	6mm shafts	0.20	OETL-ZK19
Shaft Extension Coupler	Joins two shafts together for applications where extended length is required	6mm shafts 12mm shafts	0.26 0.26	OESA-ZX167 OETL-ZX95
Shaft Guide	Fits all pistol grip handles, mounts on the inside of the enclosure door with provided hardware	pistol handles	-	OHZX10

Busbar connections

Accessory Type	Description	For Use On	Weight	Catalog number
Busbar Connections	Vertical, back or edgewise mounting $\text{\textcircled{D}}$	OETL-NF1600 - 3150	46.2 31.0	OETL-ZX115 OETL-ZX114

Locking accessories

Accessory Type	Description	For Use On	Weight	Catalog number
Cam Attachment	For Kirk Key, Castell, Low & Fletcher and Ronis interlock. For adapting to the interlock system. The interlock is not included.	OS60-OS200	0.25	OETL-ZW16
		OS400-OS1200	0.29	OETL-ZW5
Electrical Interlock	Closed circuit principle for interlocking the switch movement. When the coil circuit is dead, A-types cannot be operated to O-position and L-types cannot be operated to ON- or OFF-position. Coil voltages 110VAC, 220 VAC, 24VDC, 48VDC, 60VDC, 110VDC, 220VDC, P - 15W U = 0.7 - 1.1 Un (U = coil voltage, Un = nominal voltage)	OETL-NF800 - 3150A, OES800	2.42	OETL-ZT80 Δ OETL-ZT80L Δ

Δ = Coil Voltage

Replacement parts

Accessory Type	Description	For Use On	Catalog number
Non-fusible			
Metal collar	Replaces original black knob for locking shaft in place	OT16-200, OS30-200	OTZS2
Set screw	Set screw for use with knob or collar	OT16-200 OS30-200	FLSWM5X8AX
Shaft set screw	Shaft set screw, bag of 10	OT400-1200	OZX1
Fusible			
Terminal cover	Covers terminal below fuse carrier	OS30	CXBY67121
Phase barrier	-	OS200	CXBY68794
Shaft Set Screw	-	OS30_	FLSWM5X8AX
	Bag of 10	OS400-1200	OZX1
Fuse covers	-	OS100GJ_	CXBY69058 CXBY69072

$\text{\textcircled{D}}$ Vertical busbar is provided as standard on OETL-NF1600 through OETL-NF3150 switches.

Conversion, transfer & bypass mechanisms

Mechanical interlocks

Disconnect
switches
Accessories

Conversion mechanisms

Mechanism Type	For use on	Weight	UL/Nema Type	Catalog number
6 or 8 pole mechanisms	OT16-100	0.33	-	OTZW8
	OT160	1.52	-	OETL-ZK19
	OS30-200, OT200	1.52	-	OESA-ZW2
	OT400 – OETL-NF1200	2.42	-	OETL-ZW9
Double throw mechanisms	OT16 - 160	2.20	1, 3R, 12 1, 3R, 12, 4, 4X	OESA-ZW1 OESA-ZW1X
	OT200 OS30-200	2.20	1, 3R, 12 1, 3R, 12, 4, 4X	OTZW25 OTZW25X
	OT400 – OETL-NF1200	10.10	1, 3R, 12, 4, 4X	OETL-ZW12
Bypass mechanisms	OT16-OT100	1.54	1, 3R, 12 1, 3R, 12, 4, 4X	OTZW17 OTZW17X
	OT200, OS30-200	7.28	1, 3R, 12	OTZW26
	OT400 – OETL-NF1200	8.81	1, 3R, 12, 4, 4X	OETL-ZW13
Mechanical interlock mechanisms	OT16-OT100	0.33	-	OTZW24
	OT160-200, OS30-200	0.55	-	OTZW10
	OT400 – OETL-NF800	1.26	-	OETL-ZW3
	OETL-NF1200 – OETL-NF3150	2.64	-	OETL-ZW15

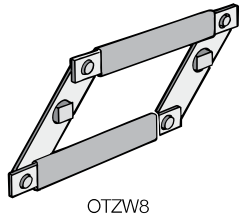

OTZW8

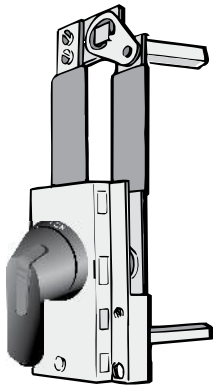

OTZW6

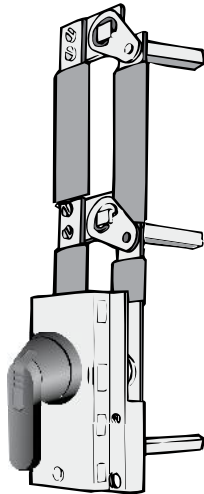

OTZW17



OETL-ZW24

6 or 8 pole

6 (8) pole mechanism allows two switches controlled by one handle to open or close simultaneously.

Equipment required for a complete installation:

- One conversion mechanism
- Two disconnect switches (see page 19.11)
- One handle[Ⓟ] (see page 19.30)
- Two shafts (see page 19.32)

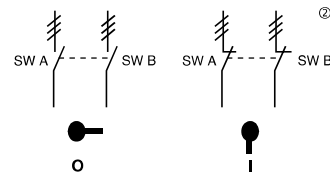

	POS. O	POS. I
SW. A	O	X
SW. B	O	X

X = Closed
O = Open

Transfer

Transfer mechanism manually transfers between two power sources using two switches and a center OFF position. A 3-position handle is included.

Shafts included. Equipment required for a complete installation:

- One conversion mechanism
- Two disconnect switches (see page 19.11.)

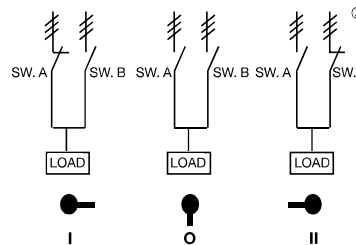

	POS. I	POS. O	POS. II
SW. A	X	O	O
SW. B	O	O	X

X = Closed
O = Open

Bypass

Bypass mechanism operates three switches: Two switches in series and one changeover switch to allow power bypass.

A 3-position handle is included. Shafts included. Equipment required for a complete installation:

- One conversion mechanism
- Three disconnect switches (see page 19.11.)

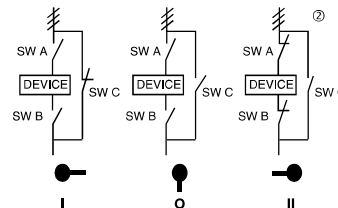

	POS. I	POS. O	POS. II
SW. A	O	O	X
SW. B	O	O	X
SW. C	X	O	O

X = Closed
O = Open

Mechanical interlock

Mechanical interlock mechanism prevents both switches from being in the ON position at the same time.

Equipment required for a complete installation:

- One conversion mechanism
- Two disconnect switches (see page 19.11)
- Two handles (see page 19.30)
- Two shafts (see page 19.32)

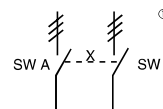

	SW. A POS. I	SW. B POS. I
SW. A	X	O
SW. B	O	X

X = Closed
O = Open

Ⓟ OT16E3 – OT32E3 can use a selector or pistol handle. All other sizes must use a pistol handle.

Ⓜ = Three poles