

OA109 Series

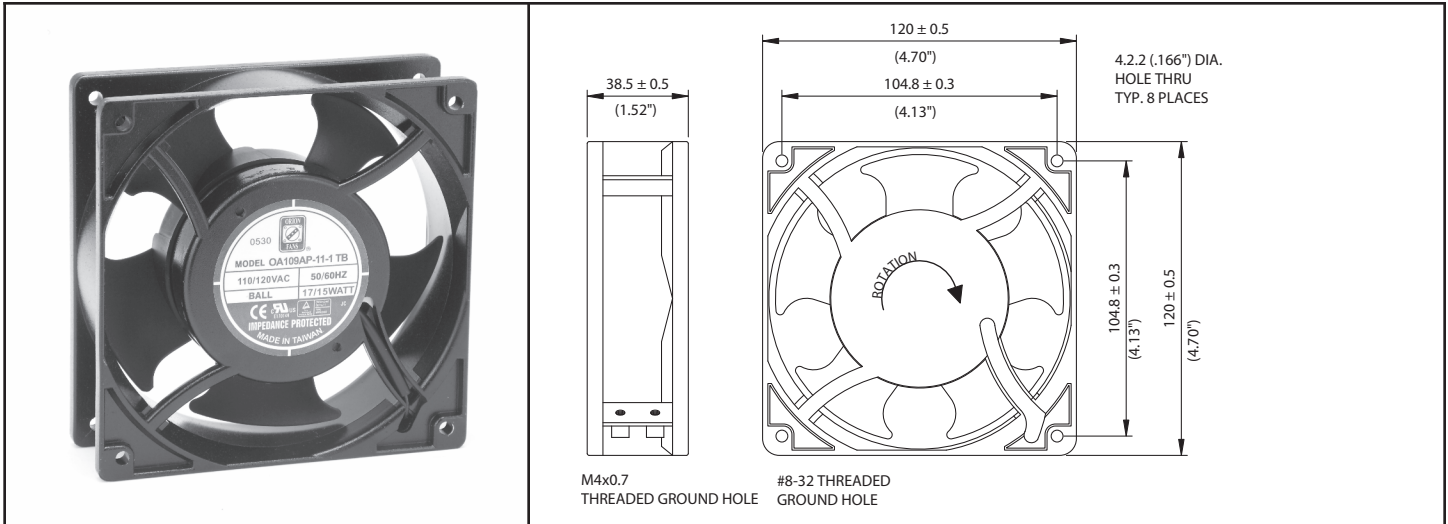

AC Fan - 115V, 230V
120x38mm (4.7"x 1.5")



Frame	Diecast Aluminum	<p>Operating Temperature Ball Bearing -20C ~ +80C Sleeve Bearing -10C ~ +50C Storage Temp -40C ~ +100C</p> <p>Life Expectancy Ball Bearing 60,000 hours (L10 at 40C) Sleeve Bearing 30,000 hours (L10 at 40C)</p> <p>Weight: ~ 1.12 lbs.</p> <p>m0</p>	
Impeller	PBT, UL94V-0 plastic		
Connection	2x 300mm Lead wires (22AWG) or terminals		
Motor	AC shaded pole, impedance protected		
Bearing System	Dual ball or Sleeve		
Insulation Resistance	>100M ohm between lead-wire and frame (500VDC)		
Dielectric Strength	1 min at 1500 VAC, 50/60Hz		

Model Number	Speed (RPM)	Airflow (CFM)	Noise (dB)	Volts AC	Voltage Range	Watts	Max. Static Pressure (H ₂ O)
OA109AP-11-1 *	3000	110	42	115	80~130	15	.28
OA109AP-11-2 *	2300	71	35	115	80~130	11	.24
OA109AP-11-3 *	1600	51	25	115	80~130	8	.15
OA109AP-22-1 *	3000	110	42	230	160~260	15	.28
OA109AP-22-2 *	2300	71	35	230	160~260	11	.24
OA109AP-22-3 *	1600	51	26	230	160~260	8	.15

* Indicate "TB" (Terminal Ball Bearing), "WB" (12" Wire Leads, Ball Bearing), "TS" (Terminal, Sleeve Bearing), "WS" (12" Wire Leads, Sleeve Bearing)