

MOSFET - Power, Single N-Channel, D²PAK7

60 V, 2.5 mΩ, 169 A



ON Semiconductor®

www.onsemi.com

NTBGS2D5N06C

Features

- Low R_{DS(on)} to Minimize Conduction Losses
- Low Q_G and Capacitance to Minimize Driver Losses
- Lowers Switching Noise/EMI
- These Devices are Pb-Free, Halogen Free/BFR Free and are RoHS Compliant

Typical Applications

- Power Tools, Battery Operated Vacuums
- UAV/Drones, Material Handling
- BMS/Storage, Home Automation

MAXIMUM RATINGS (T_J = 25°C unless otherwise noted)

Parameter		Symbol	Value	Unit	
Drain-to-Source Voltage		V _{DSS}	60	V	
Gate-to-Source Voltage		V _{GS}	±20	V	
Continuous Drain Current R _{θJC} (Note 2)	Steady State	T _C = 25°C	I _D	169	A
			P _D	136	W
Power Dissipation R _{θJC} (Note 2)	Steady State	T _A = 25°C	I _D	27	A
			P _D	3.7	W
Continuous Drain Current R _{θJA} (Notes 1, 2)	Steady State	T _A = 25°C	I _D	27	A
Power Dissipation R _{θJA} (Notes 1, 2)	Steady State	T _A = 25°C	P _D	3.7	W
Pulsed Drain Current	T _A = 25°C, t _p = 100 μs	I _{DM}	680	A	
Operating Junction and Storage Temperature Range		T _J , T _{stg}	-55 to +175	°C	
Source Current (Body Diode)		I _S	113	A	
Single Pulse Drain-to-Source Avalanche Energy (I _L = 23.1 A _{pk} , L = 1 mH)		E _{AS}	266	mJ	
Lead Temperature for Soldering Purposes (1/8" from case for 10 s)		T _L	260	°C	

Stresses exceeding those listed in the Maximum Ratings table may damage the device. If any of these limits are exceeded, device functionality should not be assumed, damage may occur and reliability may be affected.

1. Surface-mounted on FR4 board using a 1 in², 1 oz. Cu pad.
2. The entire application environment impacts the thermal resistance values shown, they are not constants and are only valid for the particular conditions noted.

V _{(BR)DSS}	R _{DS(ON)} MAX	I _D MAX
60 V	2.5 mΩ @ 12 V	169 A
	2.65 mΩ @ 10 V	

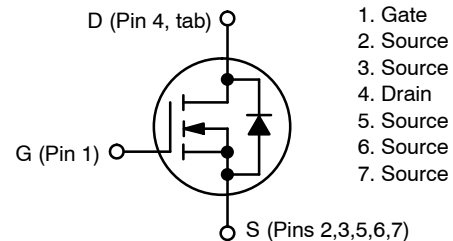

N-CHANNEL MOSFET

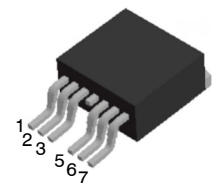

D²PAK7
CASE 221BP

MARKING DIAGRAM

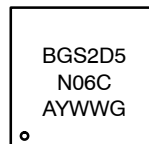

BGS2D5N06C = Specific Device Code
A = Assembly Location
Y = Year
WW = Work Week
G = Pb-Free Package

ORDERING INFORMATION

Device	Package	Shipping†
NTBGS2D5N06C	D ² PAK7 (Pb-Free)	800 / Tape & Reel

†For information on tape and reel specifications, including part orientation and tape sizes, please refer to our Tape and Reel Packaging Specifications Brochure, BRD8011/D.

NTBGS2D5N06C

THERMAL RESISTANCE MAXIMUM RATINGS

Parameter	Symbol	Value	Unit
Junction-to-Case – Steady State (Note 2)	$R_{\theta JC}$	1.1	°C/W
Junction-to-Ambient – Steady State (Note 1)	$R_{\theta JA}$	40	

ELECTRICAL CHARACTERISTICS ($T_J = 25^\circ\text{C}$ unless otherwise specified)

Parameter	Symbol	Test Condition	Min	Typ	Max	Unit
-----------	--------	----------------	-----	-----	-----	------

OFF CHARACTERISTICS

Drain-to-Source Breakdown Voltage	$V_{(BR)DSS}$	$V_{GS} = 0\text{ V}, I_D = 250\ \mu\text{A}$	60			V
Drain-to-Source Breakdown Voltage Temperature Coefficient	$V_{(BR)DSS}/T_J$	$I_D = 175\ \mu\text{A}$, ref to 25°C		18.4		mV/°C
Zero Gate Voltage Drain Current	I_{DSS}	$V_{GS} = 0\text{ V}, V_{DS} = 60\text{ V}$	$T_J = 25^\circ\text{C}$		10	μA
			$T_J = 125^\circ\text{C}$		100	μA
Gate-to-Source Leakage Current	I_{GSS}	$V_{DS} = 0\text{ V}, V_{GS} = 20\text{ V}$			100	nA

ON CHARACTERISTICS (Note 3)

Gate Threshold Voltage	$V_{GS(TH)}$	$V_{GS} = V_{DS}, I_D = 175\ \mu\text{A}$	2.0	3.0	4.0	V
Negative Threshold Temperature Coefficient	$V_{GS(TH)}/T_J$	$I_D = 175\ \mu\text{A}$, ref to 25°C		-8		mV/°C
Drain-to-Source On Resistance	$R_{DS(on)}$	$V_{GS} = 12\text{ V}, I_D = 35\text{ A}$		2.0	2.5	m Ω
		$V_{GS} = 10\text{ V}, I_D = 17\text{ A}$		2.2	2.65	
Gate-Resistance	R_G	$T_A = 25^\circ\text{C}$		1.1		Ω

CHARGES, CAPACITANCES & GATE RESISTANCE

Input Capacitance	C_{ISS}	$V_{GS} = 0\text{ V}, V_{DS} = 30\text{ V}, f = 1\text{ MHz}$		3510		pF
Output Capacitance	C_{OSS}			1950		
Reverse Transfer Capacitance	C_{RSS}			35		
Total Gate Charge	$Q_{G(TOT)}$	$V_{GS} = 10\text{ V}, V_{DS} = 30\text{ V}; I_D = 35\text{ A}$		45.4		nC
Threshold Gate Charge	$Q_{G(TH)}$			9		
Gate-to-Source Charge	Q_{GS}			14.7		
Gate-to-Drain Charge	Q_{GD}			6.8		
Output Charge	Q_{OSS}	$V_{GS} = 0\text{ V}, V_{DS} = 50\text{ V}$		90		

SWITCHING CHARACTERISTICS (Note 4)

Turn-On Delay Time	$t_{d(ON)}$	$V_{GS} = 10\text{ V}, V_{DS} = 30\text{ V}, I_D = 35\text{ A}, R_G = 6\ \Omega$		17.9		ns
Rise Time	t_r			9.3		
Turn-Off Delay Time	$t_{d(OFF)}$			26.9		
Fall Time	t_f			13.6		

DRAIN-SOURCE DIODE CHARACTERISTICS

Forward Diode Voltage	V_{SD}	$V_{GS} = 0\text{ V}, I_S = 35\text{ A}$	$T_J = 25^\circ\text{C}$		0.82	1.2	V
			$T_J = 125^\circ\text{C}$		0.7		
Reverse Recovery Time	t_{RR}	$V_{GS} = 0\text{ V}, di_S/dt = 100\text{ A}/\mu\text{s}, I_S = 17\text{ A}$			66		ns
Reverse Recovery Charge	Q_{RR}				77.5		nC

Product parametric performance is indicated in the Electrical Characteristics for the listed test conditions, unless otherwise noted. Product performance may not be indicated by the Electrical Characteristics if operated under different conditions.

3. Pulse Test: pulse width $\leq 300\ \mu\text{s}$, duty cycle $\leq 2\%$.

4. Switching characteristics are independent of operating junction temperatures.

NTBGS2D5N06C

TYPICAL CHARACTERISTICS

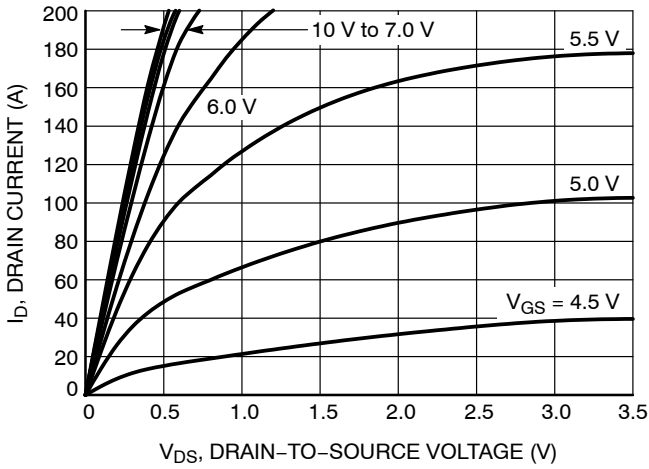

Figure 1. On-Region Characteristics

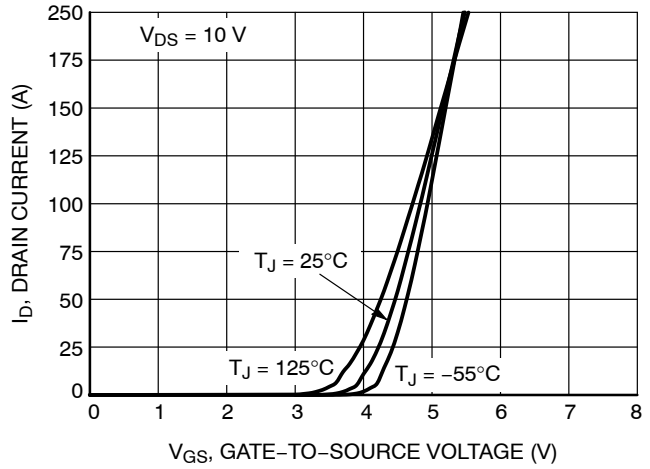

Figure 2. Transfer Characteristics

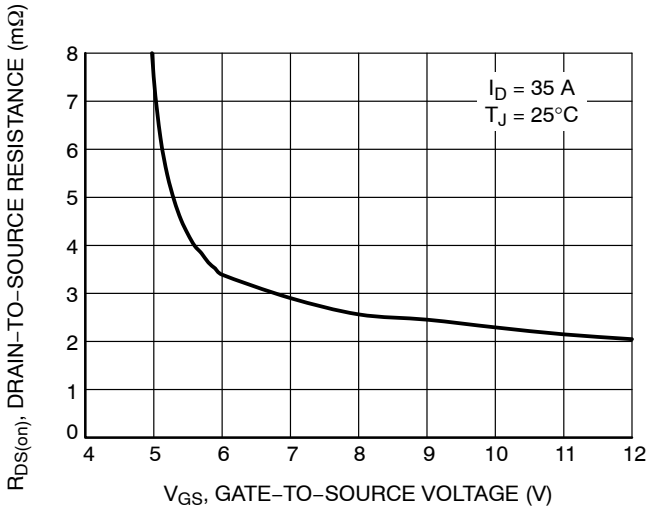

Figure 3. On-Resistance vs. Gate-to-Source Voltage

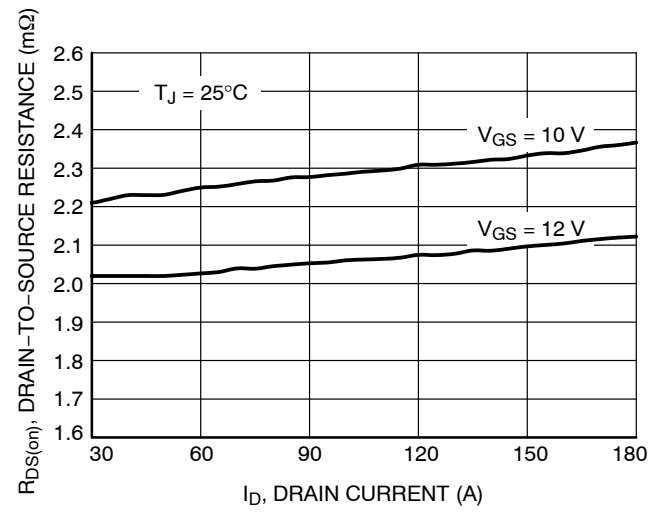

Figure 4. On-Resistance vs. Drain Current and Gate Voltage

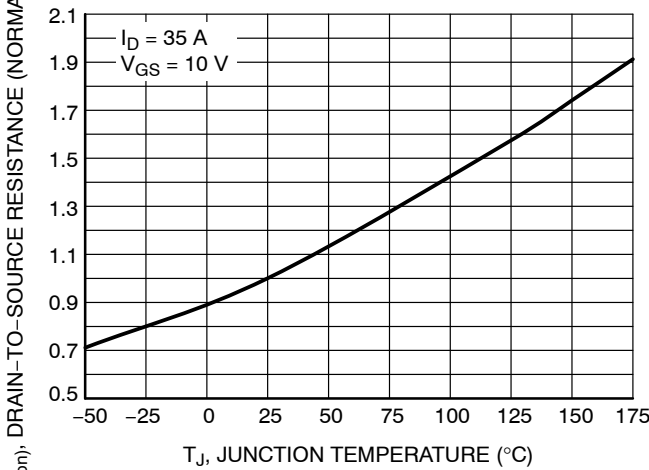

Figure 5. On-Resistance Variation with Temperature

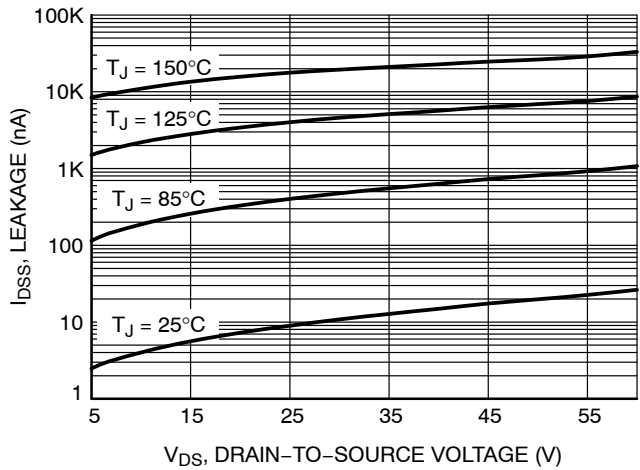

Figure 6. Drain-to-Source Leakage Current vs. Voltage

NTBGS2D5N06C

TYPICAL CHARACTERISTICS

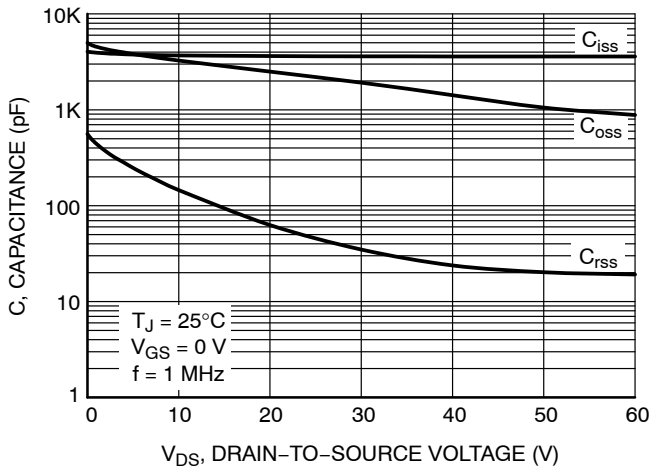

Figure 7. Capacitance Variation

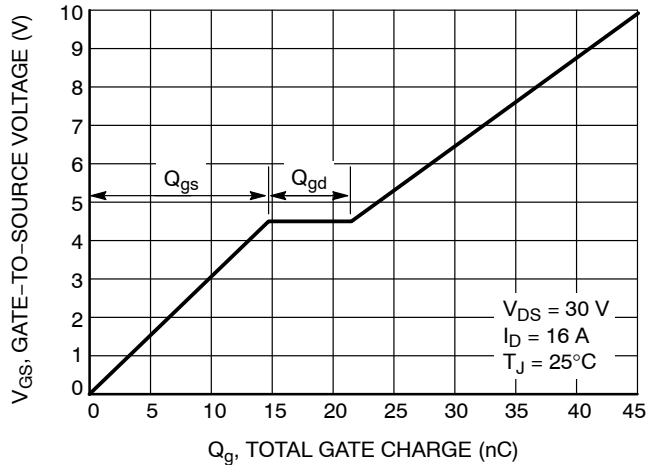

Figure 8. Gate-to-Source vs. Total Charge

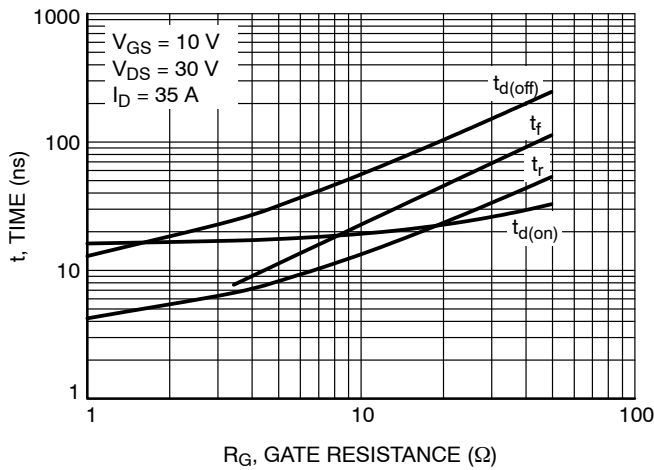

Figure 9. Resistive Switching Time Variation vs. Gate Resistance

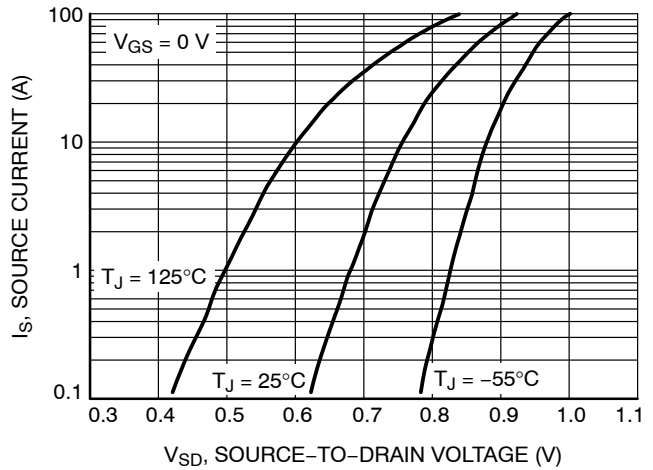

Figure 10. Diode Forward Voltage vs. Current

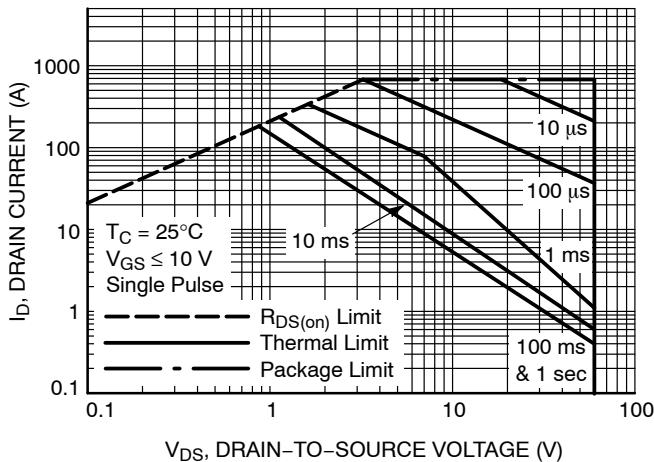

Figure 11. Maximum Rated Forward Biased Safe Operating Area

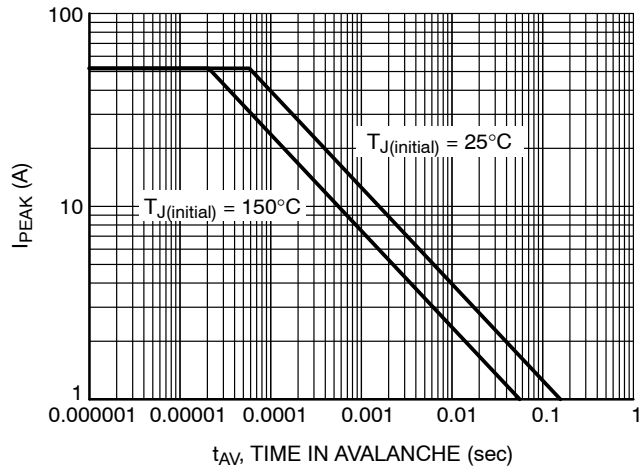

Figure 12. Maximum Drain Current vs. Time in Avalanche

NTBGS2D5N06C

TYPICAL CHARACTERISTICS

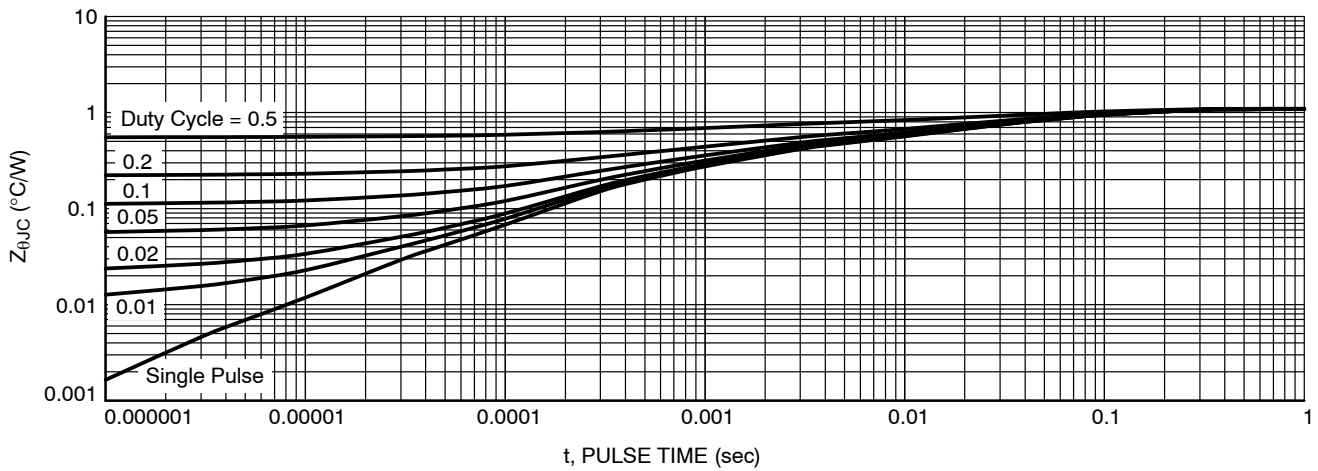
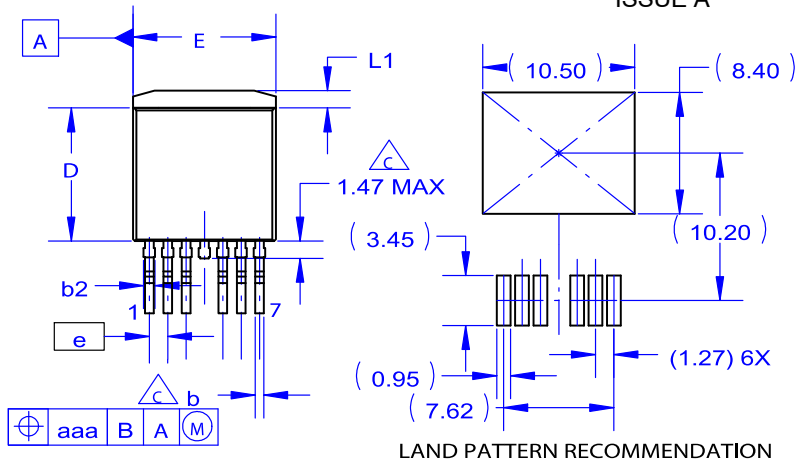

Figure 13. Transient Thermal Impedance

NTBGS2D5N06C

PACKAGE DIMENSIONS

D2PAK7 (TO-263-7LD) 15.4x9.9x4.5
 CASE 221BP
 ISSUE A



NOTES:

- A. PACKAGE CONFORMS TO JEDEC TO-263 VARIATION CB EXCEPT WHERE NOTED.
- B. ALL DIMENSIONS ARE IN MILLIMETERS.
- △ OUT OF JEDEC STANDARD VALUE.
- D. DIMENSION AND TOLERANCE AS PER ASME Y14.5-2009.
- E. DIMENSIONS ARE EXCLUSIVE OF BURRS, MOLD FLASH AND TIE BAR PROTRUSIONS.
- F. LAND PATTERN RECOMMENDATION PER IPC. TO127P1524X465-8N.

DIM	MILLIMETERS		
	MIN	NOM	MAX
A	4.30	4.50	4.70
A1	0.00	0.10	0.20
b2	0.60	0.70	0.80
b	0.50	0.60	0.70
c	0.40	0.50	0.60
c2	1.20	1.30	1.40
D	9.00	9.20	9.40
D1	7.30	7.80	8.20
E	9.70	9.90	10.20
E1	7.15	8.05	8.55
e	~	1.27	~
H	15.10	15.40	15.70
L	2.44	2.64	2.84
L1	1.00	1.20	1.40
L3	~	0.25	~
aaa	~	~	0.25

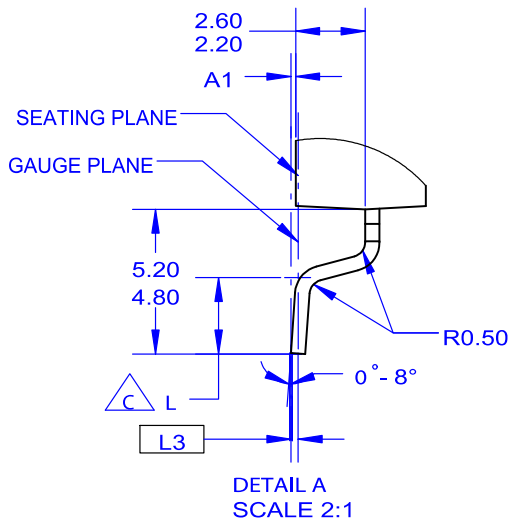
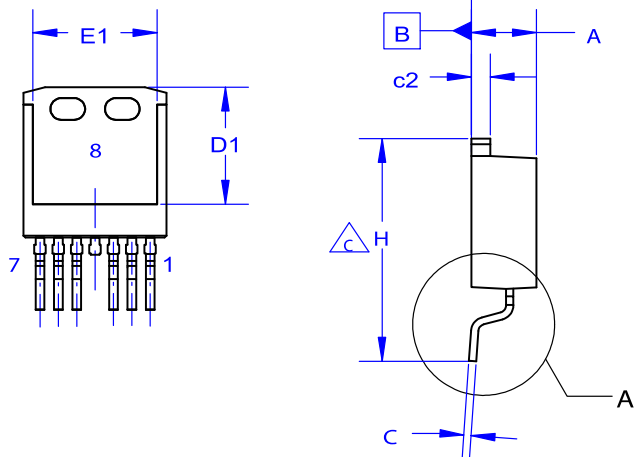

NTBGS2D5N06C

ON Semiconductor and  are trademarks of Semiconductor Components Industries, LLC dba ON Semiconductor or its subsidiaries in the United States and/or other countries. ON Semiconductor owns the rights to a number of patents, trademarks, copyrights, trade secrets, and other intellectual property. A listing of ON Semiconductor's product/patent coverage may be accessed at www.onsemi.com/site/pdf/Patent-Marking.pdf. ON Semiconductor reserves the right to make changes without further notice to any products herein. ON Semiconductor makes no warranty, representation or guarantee regarding the suitability of its products for any particular purpose, nor does ON Semiconductor assume any liability arising out of the application or use of any product or circuit, and specifically disclaims any and all liability, including without limitation special, consequential or incidental damages. Buyer is responsible for its products and applications using ON Semiconductor products, including compliance with all laws, regulations and safety requirements or standards, regardless of any support or applications information provided by ON Semiconductor. "Typical" parameters which may be provided in ON Semiconductor data sheets and/or specifications can and do vary in different applications and actual performance may vary over time. All operating parameters, including "Typicals" must be validated for each customer application by customer's technical experts. ON Semiconductor does not convey any license under its patent rights nor the rights of others. ON Semiconductor products are not designed, intended, or authorized for use as a critical component in life support systems or any FDA Class 3 medical devices or medical devices with a same or similar classification in a foreign jurisdiction or any devices intended for implantation in the human body. Should Buyer purchase or use ON Semiconductor products for any such unintended or unauthorized application, Buyer shall indemnify and hold ON Semiconductor and its officers, employees, subsidiaries, affiliates, and distributors harmless against all claims, costs, damages, and expenses, and reasonable attorney fees arising out of, directly or indirectly, any claim of personal injury or death associated with such unintended or unauthorized use, even if such claim alleges that ON Semiconductor was negligent regarding the design or manufacture of the part. ON Semiconductor is an Equal Opportunity/Affirmative Action Employer. This literature is subject to all applicable copyright laws and is not for resale in any manner.

PUBLICATION ORDERING INFORMATION

LITERATURE FULFILLMENT:

Email Requests to: orderlit@onsemi.com

ON Semiconductor Website: www.onsemi.com

TECHNICAL SUPPORT

North American Technical Support:
Voice Mail: 1 800-282-9855 Toll Free USA/Canada
Phone: 011 421 33 790 2910

Europe, Middle East and Africa Technical Support:

Phone: 00421 33 790 2910

For additional information, please contact your local Sales Representative