

NRA Series



NRAS



NRAN



NRAR
Rocker



NRAR
Illuminated Rocker
(neon lamp)

Key features of the NRA series include:

- Available in 4 different styles
- Excellent overload and short circuit protection
- Small size and high-efficiency
- Life expectancy of over 10,000 operations
- UL1077 recognized "Supplementary Protectors"
- VDE certified to EN60934



File No. E68029



license #116381

Specifications	Protection Method	Electromagnetic tripping
	Internal Circuit	Series current trip
	Number of Poles	NRAS and NRAN: 1, 2, 3 NRAR: 1
	Rated Voltage	250V AC, 50/60Hz, 65V DC
	Rated Tripping Currents	0.3A, 0.5A, 0.75A 1A, 2A, 3A, 5A, 7.5A, 10A, 15A, 20A, 25A, 30A
	Rated Interrupting Capacity	250V AC, 50/60Hz, 1,000A 65V DC, 1,000A
	Auxiliary Contact	SPDT microswitch 250V AC, 5A (resistive load)
	Alarm Contact	50V DC, 1A (resistive load)
	Reference Temperature	25°C
	Operating Temperature	-40 to +85°C (avoid freezing)
	Insulation Resistance	100MΩ minute (measured with 500V megger)
	Dielectric Strength	Between main circuit terminals: 2,000V AC, 1 minute Between main circuit and auxiliary contact: 2,000V AC, 1 minute
	Vibration Resistance	100N (approximately 10G) (10 to 100Hz)
	Shock Resistance	1,000N (approximately 100G)
Life Expectancy	Minimum 10,000 cycles (at 6 operations per minute)	
Termination	Main terminal: Quick-connect receptacle 0.250" (accepts M3.5 screw terminal adapter) Auxiliary contact, alarm contact: Quick-connect receptacle 0.080"	
Illumination Voltage (NRAR illuminated units)	Neon: 120, 240V AC, 50/60Hz	



Not suitable for branch circuit protection.

Part Numbering Guide

NRA series part numbers are composed of up to 8 part number codes. When ordering an NRA series part, select one code from each category.
 Example: NRAR 1 1 11 -F - 30A -AA -31

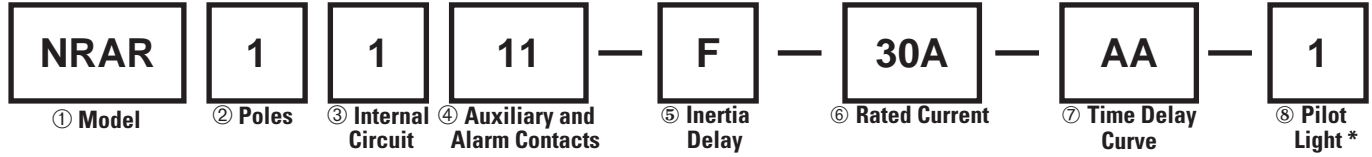

Part Number Codes: NRA Series

	Description	Part Number Code	Remarks
① Model	Toggle (round cutout)	NRAS	
	Toggle (rectangular cutout)	NRAN	
	Rocker	NRAR	
② No. of Poles	1-pole	1	NRAR available in 1-pole only. All multi-pole circuit breakers are simultaneous throw/simultaneous break. All levers are mechanically interlocked.
	2-pole	2	
	3-pole	3	
③ Internal Circuit	Series current trip	1	
④ Auxiliary and Alarm Contacts	Without	00	
	With auxiliary contact	11	Auxiliary contact switches change state with lever and/or overload condition
	With alarm contact	21	Alarm contact switches change state only with overload condition
⑤ Inertia Delay	Without inertia delay	Blank	
	With inertia delay	F	
⑥ Rated Current	Rated current (current trip)	0.3A, 0.5A, 0.75A, 1A, 2A, 3A, 5A, 7.5A, 10A, 15A, 20A, 25A, 30A	All current ratings must be listed in amps (A). Example conversion: 300mA = 0.30A.
⑦ Time Delay Curve	DC curves	AD, MD	For time delay curves, see page N-7.
	AC curves	AA, BA,MA	
⑧ Pilot Light*	With neon light 120V AC (50/60Hz)	1	* Applicable to illuminated NRAR only.
	With neon light 240V AC (50/60Hz)	2	



1. For NRA series accessories, see page N-6.
2. For NRA series time delay curves, see page N-7.
3. For NRA series dimensions, see page N-10.
4. Not suitable for branch circuit protection.
5. UL recognized, applicable standard: UL1077, "Supplementary Protectors."



Information About Circuit Breakers

Time Delay Curve Descriptions

Time Delay Curve	NRA Application
AD, AA	Common curves used in molded-case circuit breakers.
BA	Response to overcurrent is quite fast. Suited for protection of semiconductor circuits with very little overload tolerance. If overcurrents are expected to flow, fuses may be required according to the circuit characteristics.
MD, MA	Suited for motor loads that draw high inrush currents lasting a considerable length of time.
With Inertia Delay (F)	Designed not to trip on 20 times the rated current (peak value) for a duration of 8ms. Suited for transformer and lamp loads that draw steep inrush currents.

Inertia Delay Descriptions

Circuit breakers equipped with inertia delay do not respond to high inrush currents such as those produced by transformer, lamp, or motor loads, but perform the specified interruption on the rated overcurrents.

Specify inertia delay by inserting an "F" in the part number as shown in Part Number Guide on previous page.

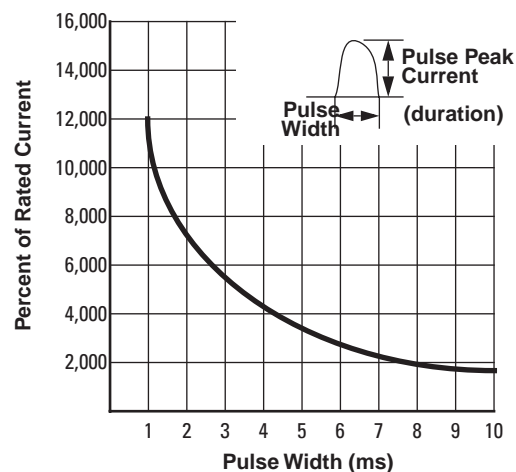

$$1. \text{ Percent of Rated Current} = \frac{\text{Pulse Peak Current}}{\text{Protector Rated Current}} \times 100\%$$

2. Based on sinusoidal or parabolic pulse profile.

Notes

Multi-Pole

Multi-pole types such as 2- or 3-pole should be assembled by IDEC.

Because of their characteristics, 1-pole breakers cannot be combined to provide multi-pole units.

Auxiliary and Alarm Contacts



Multi-pole units can incorporate auxiliary and alarm contacts.

Auxiliary and alarm contacts will not work with IDEC's DIN rail adapters.

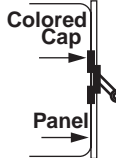

Accessories

Part Numbers: NRA Series Accessories

Description	Appearance	Part No.	Remarks
Color Caps (NRAS only)	Red	NR5R	 <p>Colored caps fit onto NRAS circuit breakers for color coding circuits and improving the appearance of the panel.</p>
	Blue	NR5S	
	Yellow	NR5Y	
	White	NR5H	
Screw Terminal Adapter (1 pair)		NRT	For use on main terminals only. Includes M3.5 clamp screw. For dimensions see page N-10.

Part Numbers: NRA Mounting Accessories

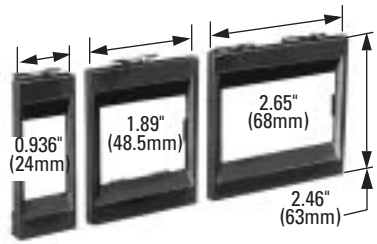
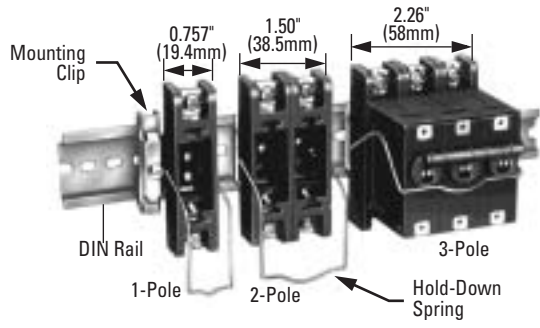
Description	Appearance	For Model	No. of Poles	Part No.	Remarks
Panel Mount Flush Plate		NRAN NRAR	1-pole	NR31	Use of a flush plate makes snap-in mount possible for NRAN, and NRAR circuit breakers (tightening screws not necessary). Multiple units can mount in a single panel cut-out.
		NRAN	2-pole	NR32	
		NRAN	3-pole	NR33	
DIN Rail Plug-in Base		NRAS NRAN	1-pole	NR21	<ol style="list-style-type: none"> Furnished with a hold-down spring. Applicable only for series trip units up to 20 amps. Not applicable for NRAR lighted series. Not for use with circuit breakers incorporating auxiliary or alarm contacts.
		NRAS NRAN	2-pole	NR22	
		NRAS NRAN	3-pole	NR23	
		NRAR	1-pole	NR211	
Surface Mount Plug-in Base		NRAS NRAN	1-pole	NUS1	
		NRAS NRAN	2-pole	NUS2	
		NRAS NRAN	3-pole	NUS3	
		NRAR	1-pole	NUS11	



For dimensions of NRA series accessories and panel cut-out layouts, see drawings starting on page N-10.

Internal Circuits and Terminal Arrangements: NRAS and NRAM Series

Series Current Trip

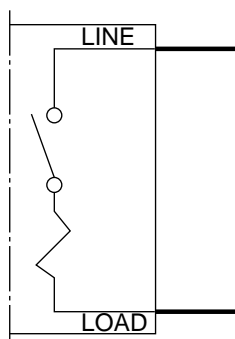

Series Current Trip with Auxiliary Contacts

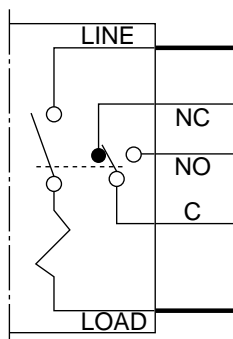

Series Current Trip with Alarm Contacts

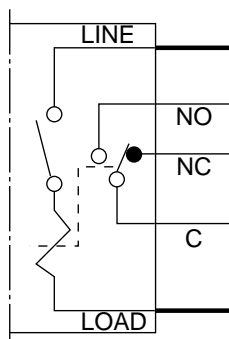

Internal Circuits and Terminal Arrangements: NRAR Series

Series Current Trip

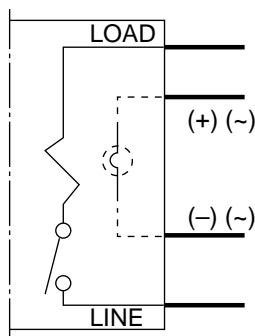

Series Current Trip with Auxiliary Contacts

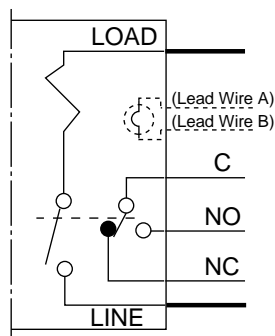

Series Current Trip with Alarm Contacts

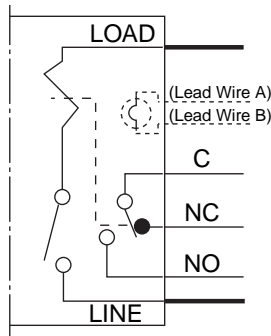

Pilot Lights (NRAR only)

Pilot Light	Lead Wire	
	A	B
Neon (120V AC)	White	White
Neon (240V AC)	Black	Black



Dashed lines represent NRAR illuminated rocker units. Lead wires for neon pilot light as shown above.

Time Delay Curves (numerical equivalent)

Overcurrent — Time Delay Characteristics in Seconds (at 25°C)

		Percent of Rated Current								
		Curve	100%	125%	150%	200%	400%	600%	800%	1000%
DC	AD	No trip	10 – 130	6 – 55	2.6 – 20	0.5 – 3.5	0.12 – 1.4	0.008 – 0.1	0.005 – 0.05	
	MD	No trip	35 – 400	20 – 200	7 – 60	1.3 – 8	0.2 – 3	0.01 – 0.25	0.006 – 0.08	
AC (50/60Hz)	AA	No trip	10 – 120	6 – 45	2.2 – 15	0.3 – 2	0.05 – 0.55	0.007 – 0.13	0.005 – 0.04	
	BA	No trip	0.75 – 10	0.45 – 3.5	0.22 – 1.3	0.045 – 0.22	0.012 – 0.12	0.005 – 0.06	0.004 – 0.03	
	MA	No trip	60 – 900	30 – 260	9 – 70	1.5 – 8	0.18 – 2.5	0.009 – 0.25	0.006 – 0.08	



- All values above are in seconds.
- Data in this table is equivalent to information presented in following time delay curves.

DC Time Delay Curves

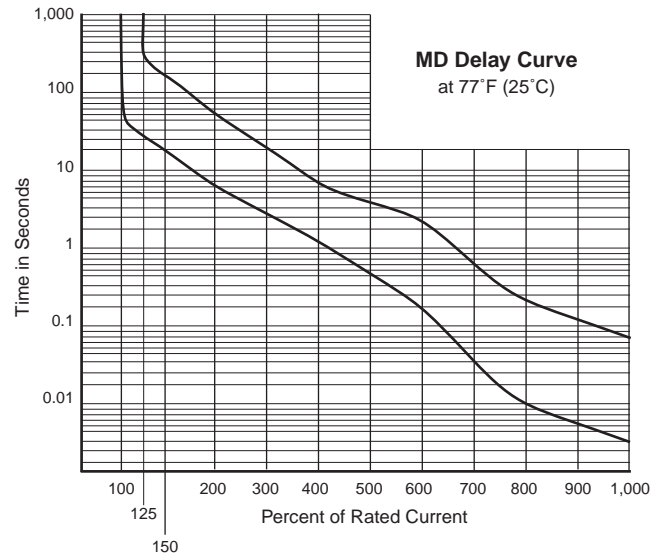
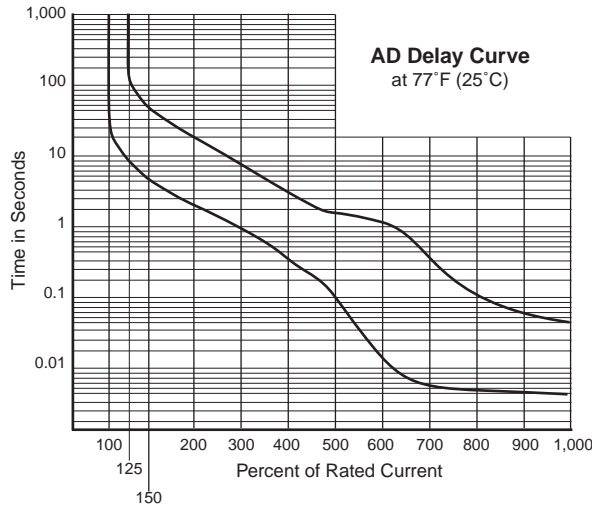

AC (50/60Hz) Time Delay Curves

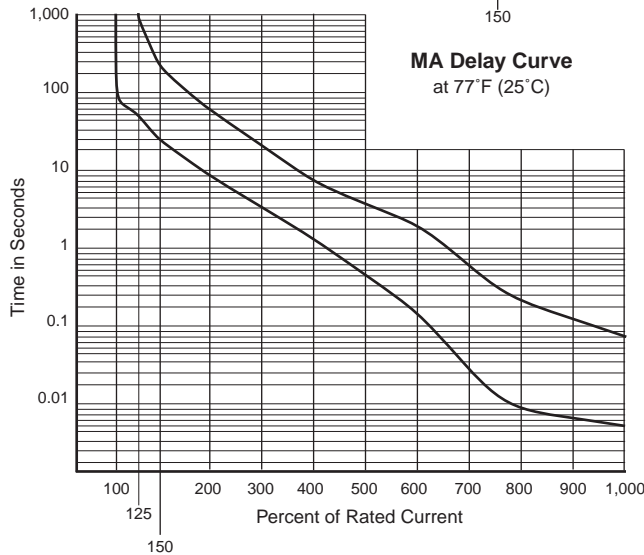
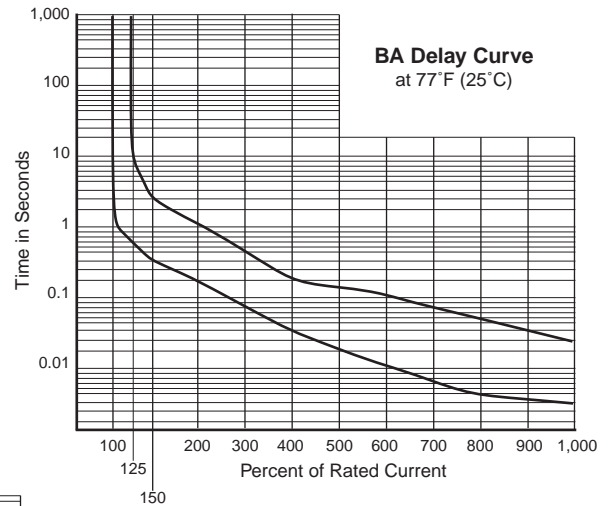
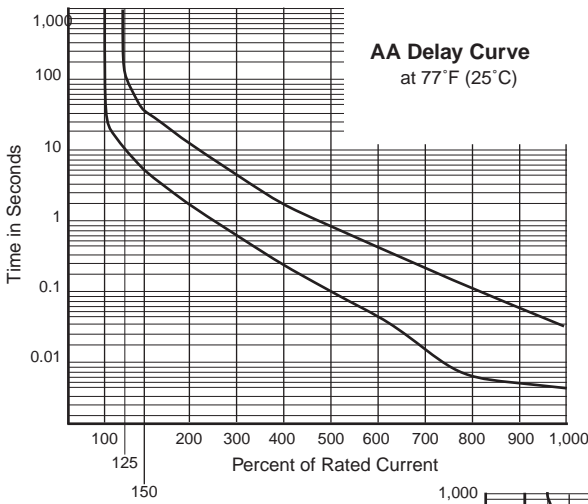

Resistance and Impedance Characteristics

Coil Data for Series Current Trip at 25°C

Rated Current	DC Resistance	AC Impedance (50/60Hz)
	Curves AD, MD	Curves AA, BA, MA
0.3A	9.67Ω	9.82Ω
0.5A	3.24Ω	3.36Ω
0.75A	1.45Ω	1.49Ω
1A	0.90Ω	0.92Ω
2A	0.21Ω	0.21Ω
3A	0.09Ω	0.092Ω
5A	0.036Ω	0.036Ω
7.5A	0.017Ω	0.018Ω
10A	0.012Ω	0.012Ω
15A	0.0066Ω	0.0068Ω
20A	0.0048Ω	0.0048Ω
25A	0.0043Ω	0.0043Ω
30A	0.0036Ω	0.0041Ω



Tolerance ±25% (up to 20A), ±50% (25A and over).

Voltage Drop Due to Resistance or Impedance

The internal resistance or impedance of a circuit breaker tends to be larger for a smaller rated current. Therefore, when circuit breakers with a small rated current are used, voltage drop should be taken into consideration. Internal resistance also varies with time delay curves, even at the same rated current. This should also be considered during installation.

Time Delay Curve and Ambient Temperature

Since NRA series circuit breakers employ an electromagnetic tripping system, the rated current (trip current) is not affected by the ambient temperature, but the time delay varies with the oil viscosity in the tube. Lower oil viscosity at higher temperatures results in shorter delay; whereas at lower temperatures, the delay will be prolonged. The time delay curves, shown starting on page N-7, are at 25°C. Time delay curves can be corrected.

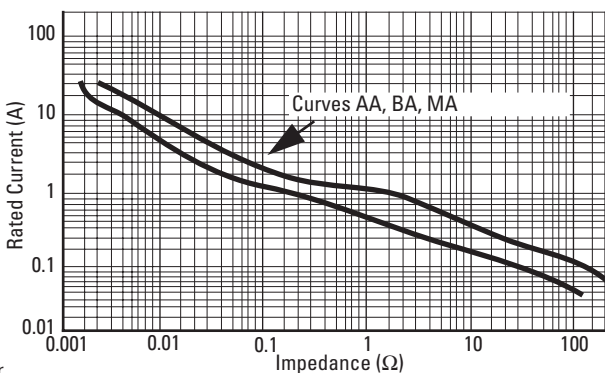
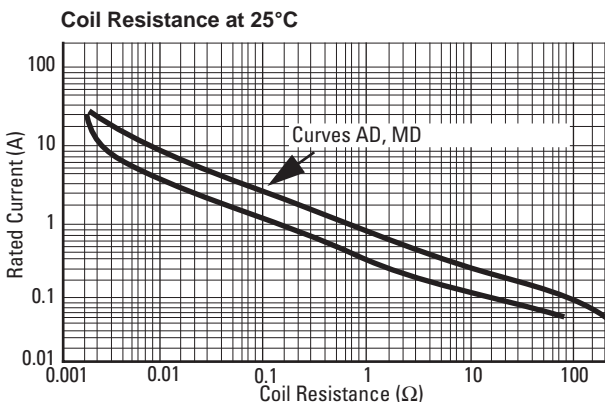

Temperature Correction Curves

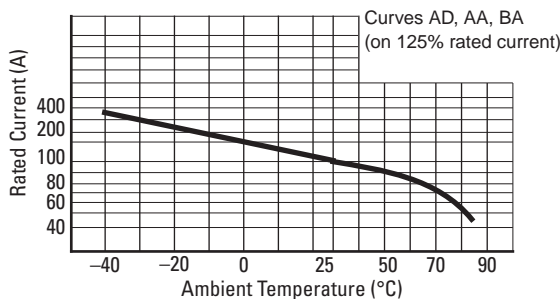

Dimensions

NRAS

1-pole

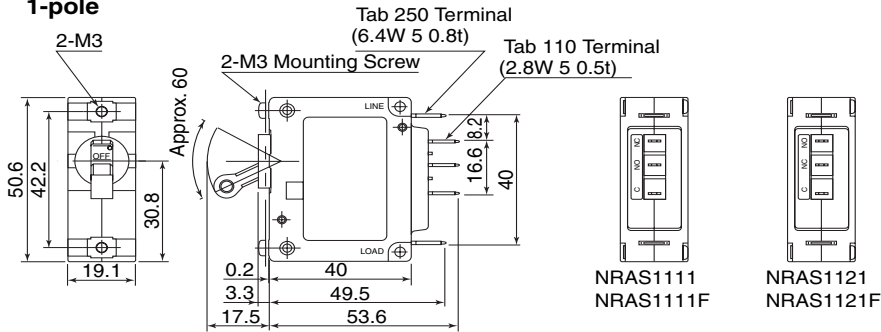

2-pole

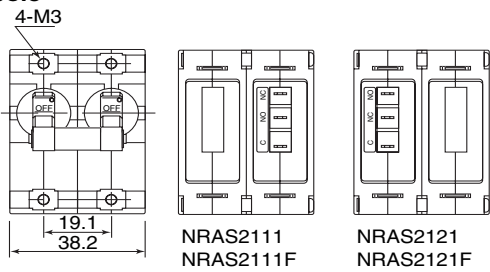

3-pole

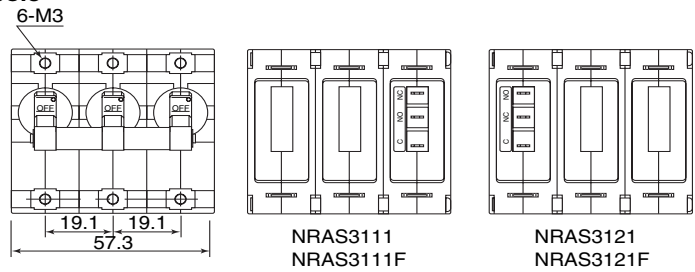

NRRAN

1-pole

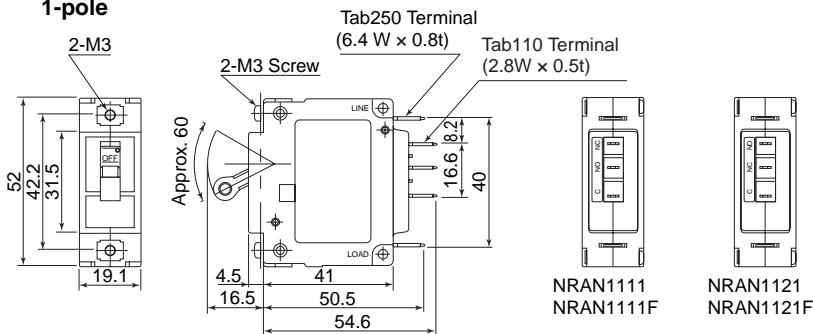

2-pole

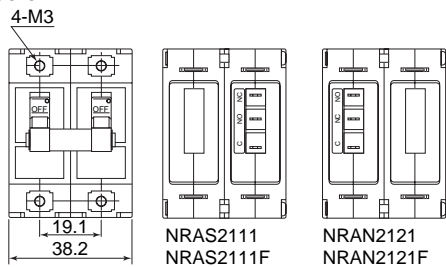

3-pole

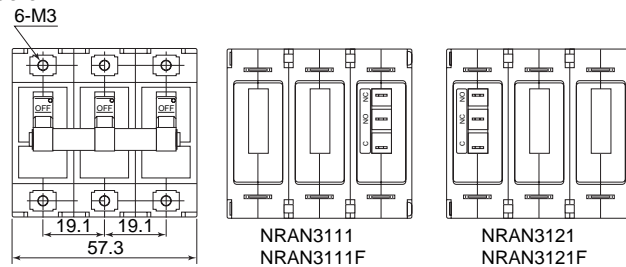

NRRAR

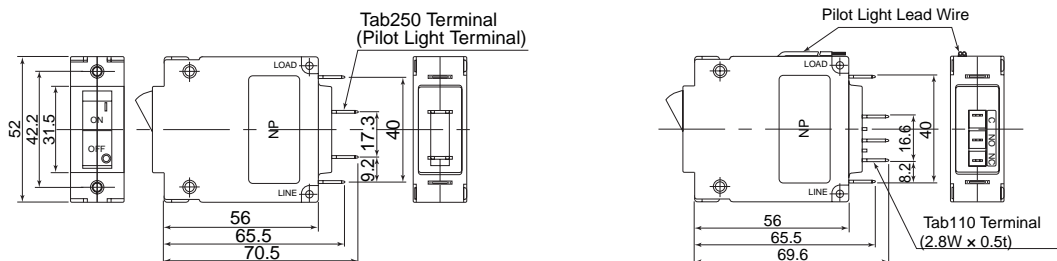

Circuit Breakers

Panel Cut-Outs



Installation Angle: Circuit breakers are designed to operate on a vertical surface. The mounting angle should not exceed a vertical plane by more than 10°.

NRA Series

NRAS

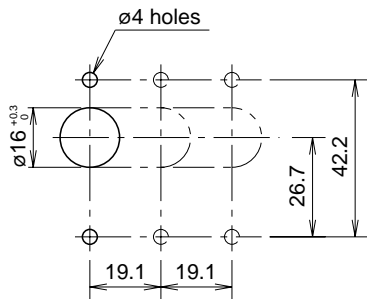

NRAR, NRAN

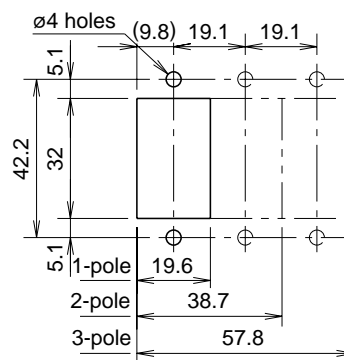

NR31, NR32, NR33 — Panel Mount Flush Plate

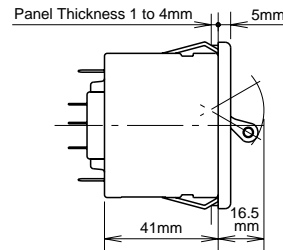
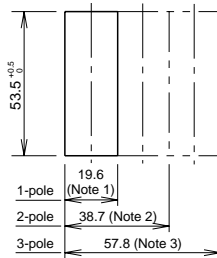

Panel cut-out when two or more units are mounted closely (n = number of units).

Note 1: 24.3n - 5
 Note 2: 48.8n - 10
 Note 3: 69.3n - 10

Model	Maximum Mounting Distance	
	A	B
NRAS	3.02" (77.5mm)	3.57" (91.5mm)
NRAN	3.02" (77.5mm)	3.57" (91.5mm)
NRAR	3.38" (86.7mm)	3.93" (100.7mm)

Schematics in mm

Mounting to Panel Surface

When mounted on a panel

Mounting to DIN Rail

When mounted on a DIN Rail

Accessory Dimensions

NRT: Screw Terminal Adapter (for use with NRA Series)

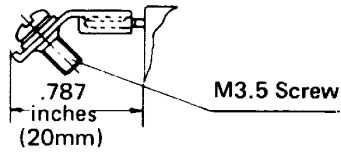

- 1. For use on main terminals only.
- 2. Includes M3.5 clamp screw.

BNDN1000 Aluminum DIN Rail

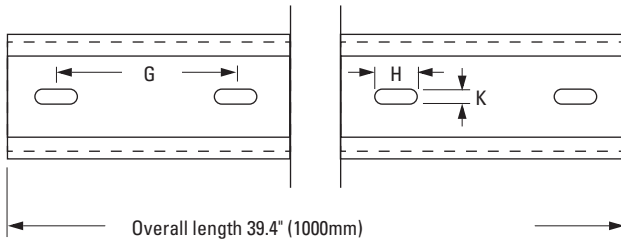

	Length in Inches (mm)
A	1.4" (35mm)
B	1.14" (29mm)
C	0.78" (23mm)
D	1.2" (31mm)
E	0.41" (10.5mm)
F	0.11" (3mm)
G	2" (51mm)
H	0.47" (12mm)
K	0.16" (4mm)



Instructions: All Series

General

IDEC's circuit breakers have been developed for the protection of electrical circuits and small-sized electrical equipment and provide excellent protection against overloads and short-circuits.

Additionally, IDEC's circuit breakers are designed to suit specific needs. Each series offers unique circuit protection characteristics and a choice of actuator styles.

IDEC's Circuit Breaker Features

- Various models are available with different internal circuits, tripping characteristics, and rated currents
- 1- to 3- multi-pole
- Inertia delay
- Auxiliary contacts and alarm contacts
- The electromagnetic tripping system is not affected by ambient temperature
- Safe trip-free mechanism
- Vibration- and impact-resistant design
- When using accessories such as plug-in bases, flush plates, and colored caps, a variety of mounting styles is possible — such as DIN rail mounting, snap mounting into panel cut-outs, and color-coded arrangement on the panel

Mounting Instructions: Installation Angle

Designed to be mounted on a vertical surface, the circuit breakers should be mounted on a surface within 10° of the vertical plane. If the circuit breaker is mounted on a horizontal surface or at any angle other than the specified angle, its characteristics will be changed.

Multi-Pole Assemble

Multi-pole types such as 2- or 3-pole should be assembled by IDEC. **Because of their characteristics, 1-pole breakers cannot be combined to produce multi-pole units.**

Applications

The IDEC NRA circuit breaker series features superior overload and short-circuit protection. Many combinations of protection mechanisms and internal circuit connections enable wide applications.

- **Precision measuring instruments:** electronic counters, projection instruments, oscilloscopes, industrial instrumentation, and analytic devices
- **Electronic communication devices:** facsimile machines, computers, recorders
- **Industrial machinery:** printers, elevators, cranes
- **Chemical and food industry machines:** vacuum devices, wrappers, centrifuges, agitators
- **Machine tools:** mill grinders, drills, presses
- **Business machines:** automatic vendors, medical equipment, beauty salon equipment, entertainment games
- **Other:** office equipment, air-conditioners, conveyor belts, and many more

How the Breaker Operates

IDEC's hydraulic magnetic circuit breakers operate like a solenoid coil. The coil unit consists of an oil-filled tube with a metal core at one end and a pole piece and armature at the opposite end with a spring in between.

When a current load passes through the coil winding, it creates a magnetic field. As long as the current load is either at or below the nominal rating of the breaker, the metal core will remain stationary.

If the current load increases beyond the nominal rating, the strength of the magnetic field causes the core to move toward the pole-end of the tube. The oil viscosity regulates the core's movement through the tube, thereby regulating the time delay. As the percentage of current load increases, the required trip time of the breaker decreases and vice versa.

When the current reaches the overload rating, the metal core will meet the pole piece at the opposite end of the tube. At this point, the armature is attracted to the same pole piece, tripping the breaker.

In case of sudden short circuit, the magnetic field created will instantly trip the breaker.

Internal Circuits Overview

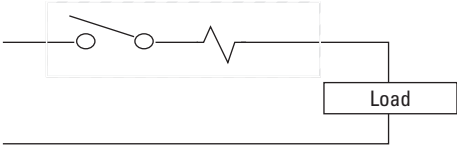
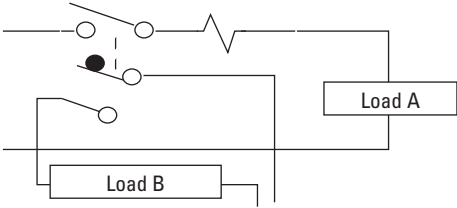
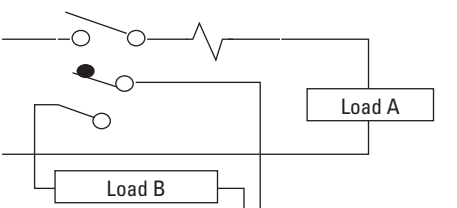
Description	Circuit Example
	<p>Series Trip This is the most common circuit breaker, providing excellent overload and short circuit protection. It can also be used as an ON/OFF switch.</p>
	<p>Series Trip with Auxiliary Contact Since the auxiliary contact operation is interlocked with the ON/OFF of the main contactor, circuit breaker operation can be monitored by a lamp or buzzer. This circuit breaker can also be used to control auxiliary circuits up to 250V AC/5A (resistive load).</p>
	<p>Series Trip with Alarm Contact Since the alarm contact is electrically independent of the main contactor, but actuates when the protective element operates. The alarm can be used with a lamp or buzzer to monitor trip operations, and can also be used for controlling alarm circuits. The contact rating is 250V AC/5A (resistive load).</p>