

FEATURES

- CLASS II DIELECTRIC, TEMPERATURE STABLE
- EXCELLENT FREQUENCY CHARACTERISTICS, NON-LINEAR CAPACITANCE CHANGE
- NICKEL BARRIER TERMINATIONS AND EXCELLENT MECHANICAL STRENGTH

**Expanded
01005
Case Size**

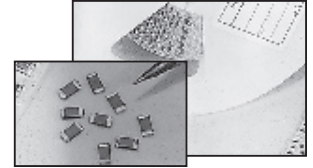

SPECIFICATIONS

Capacitance Range	100pF ~ 0.82μF (see high CV datasheet for higher capacitance values)
Capacitance Tolerance	±10% (K), ±20% (M)
Operating Temperature Range	-55°C ~ +85°C
Temperature Characteristics	±15%Δ max. over temperature range (with 0 Vdc applied)
Rated Voltages	6.3Vdc, 10Vdc, 16Vdc, 25Vdc, 35Vdc & 50Vdc (see NMC-H Series for higher voltages, NMC High Cap for higher capacitance)
Dissipation Factor	See Available Values Tables (1KHz @ +25°C)
Insulation Resistance	10,000Megohms min. or 500Megohm/μF min. whichever is less @ +25°C Except: 01005 0.1μF/6.3V 100MΩ, 0.1μF/10V = 500MΩ
Dielectric Withstanding Voltage	250% of Rated Voltage for 1 ~ 5 seconds, 50mA maximum current
Test Conditions (EIA-198-2E)	1KHz, 1.0V ±0.2Vrms

Note: Reflow soldering allowed for all case sizes. Contact NIC for wave soldering restrictions.

Typical X5R Temperature Coefficient

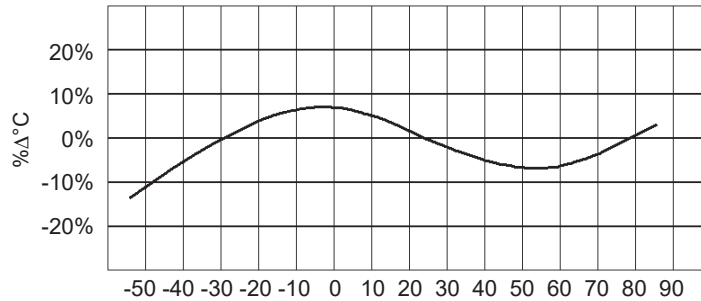

Insulation Resistance vs. Temperature

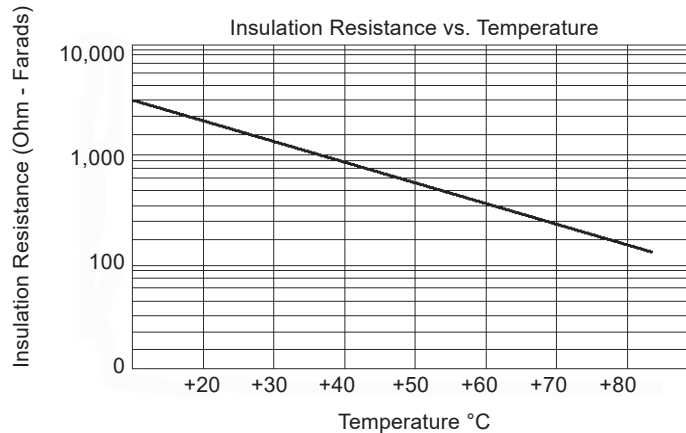

PART NUMBER SYSTEM

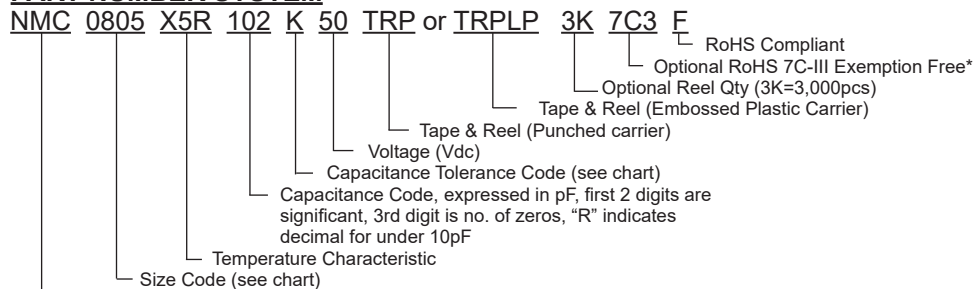

* - Part Number Level Identification of X5R MLCCs that do not take RoHS exemption 7C-III



01005 Case Size Available Values

EIA Case Size	01005	
Length (L)	0.4±0.02	
Width (W)	0.2±0.02	
Thickness max. (T)	0.22	
Termination Width (P)	0.1±0.03	
Capacitance	Working Voltage (Vdc)	
	6.3	10
100pF		7.5%
150pF		7.5%
220pF		7.5%
330pF		7.5%
470pF		7.5%
680pF		7.5%
1,000pF		7.5%
1,500pF	10%	
2,200pF	10%	
3,300pF	10%	
4,700pF	10%	
6,800pF	10%	
10,000pF	10%	10%
100,000pF	12.5%	10%

Percentage shown represent dissipation factor

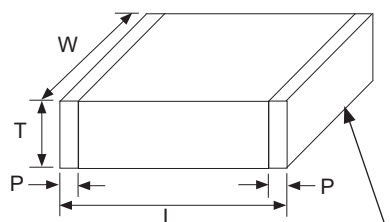

100% Sn over Ni barrier

(CONSULT FACTORY FOR CAPACITANCE VALUES NOT LISTED)

0201, 0402 & 0603 Case Size Available Values

EIA Case Size	0201			0402				0603					
Length (L)	0.6 ± 0.05			1.0±0.05				1.6±0.15					
Width (W)	0.3 ± 0.05			0.5±0.05				0.8±0.15					
Thickness max. (T)	0.33			0.6				1.0					
Termination Width (P)	0.10 ~ 0.20			0.2±0.1				0.12 ~ 0.51					
Capacitance	Working Voltage (Vdc)												
	6.3	10	6.3	10	16	25	35	6.3	10	16	25	35	50
0.0012µF	10%	7.5%											
0.0015µF	10%	7.5%											
0.0018µF	10%	7.5%											
0.0022µF	10%	7.5%											
0.0027µF	10%	7.5%											
0.0033µF	10%	7.5%											
0.0039µF	10%	7.5%											
0.0047µF	10%	7.5%	10%	7.5%	5%								
0.0056µF	10%	7.5%	10%	7.5%	5%								
0.0068µF	10%	7.5%	10%	7.5%	5%								
0.0075µF	10%	7.5%	10%	7.5%	5%								
0.0082µF	10%	7.5%	10%	7.5%	5%								
0.01µF	10%	7.5%	10%	7.5%	5%								
0.015µF	10%		10%	7.5%	5%								
0.018µF	10%		10%	7.5%	5%								
0.022µF	10%		10%	7.5%	5%								
0.027µF	10%		10%	7.5%	5%								
0.033µF	10%		10%	7.5%	5%								
0.036µF	10%		10%	7.5%	5%								
0.039µF	10%		10%	7.5%	5%								
0.047µF	10%		10%	7.5%	5%								
0.056µF	10%		10%	7.5%	5%								
0.068µF	10%		10%	7.5%	5%								
0.075µF	10%		10%	7.5%	5%								
0.082µF	10%		10%	7.5%	5%								
0.1µF	10%	10%	10%	7.5%	5%							5%	
0.15µF			10%									5%	
0.18µF			10%									5%	
0.22µF	10%		10%	7.5%	5%	10%		10%	7.5%		5%	5%	5%
0.27µF								10%	7.5%		5%		
0.33µF			10%	7.5%	5%	10%	10%	10%	7.5%	5%	5%	5%	5%
0.36µF								10%	7.5%	5%	5%		
0.39µF								10%	7.5%	5%	5%		
0.47µF			10%	10%	10%	10%	10%	10%	7.5%	5%	5%	5%	5%
0.68µF			10%			10%	10%	10%	7.5%	5%	5%	7.5%	7.5%
0.82µF								10%	7.5%	5%			

Percentage shown represent dissipation factor

See NMC High Capacitance datasheet for higher capacitance values
or NMC-H High Voltage datasheet for higher voltage ratings



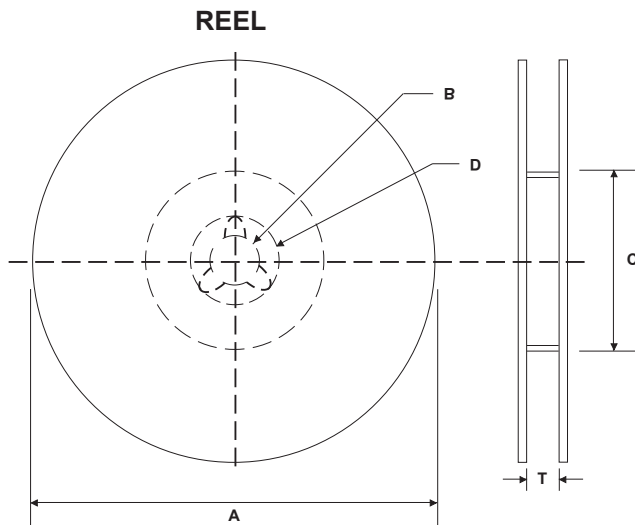

REEL DIMENSIONS (mm)

Reel Diameter (A)	B	C	D	T max.
7" (178 ± 2.0)	13 ± 0.5	50 min.	21 ± 1.0	8.4 +1.0/-0 (1812 case size 12.4 +2.0/-0)
10" (250 ± 2.0)		100 ± 1.0		
13" (330 ± 2.0)		100 ± 1.0		

7 INCH REEL QUANTITIES*

Size	01005	0201	0402	0603	0805	1206	1210	1812
Tape Size	8mm	8mm	8mm	8mm	8mm	8mm	8mm	12mm
Min. Qty Per Reel	20,000	20,000	10,000	4,000	4,000	4,000	2,000	1,000
Max. Qty Per Reel	20,000	20,000	10,000	4,000	5,000	5,000	5,000	2,000

*Quantity dependent on chip thickness. Contact NIC for reel quantities on larger diameter reels.

CARRIER TAPE MATERIAL

Parts with a thickness of $\geq 1\text{mm}$ will be taped on embossed plastic carrier. Parts with a thickness of less than 1mm will be taped on paper carrier

EMBOSSED PLASTIC CARRIER TAPE DIMENSIONS (mm)

Tape Size	W	F	E	P ₀	P ₂	D	K max.	T max.	P
8mm	8.0 ± 0.2	3.5 ± 0.05	1.75 ± 0.10	4.0 ± 0.1	2.0 ± 0.5	1.5 ^{+0.1} _{-0.0}	3.0	2.0	4.0 ± 0.1
12mm	12 ± 0.2	5.5 ± 0.05						4.5	8.0 ± 0.1

Notes:

- Specifications are in compliance with EIA RS481-1-A "Taping of surface Mount Components for Automatic Placement"
- Dimensions A₀ (max.) equals component width dimension plus 0.5mm
- Dimension B₀ (max.) equals component length dimension plus 0.5mm

EMBOSSED PLASTIC CARRIER TAPE

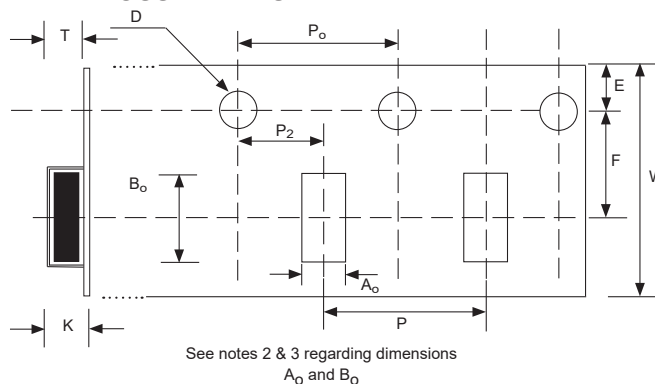

PUNCHED CARRIER TAPE DIMENSIONS (mm)

Type	A ₀	B ₀	W	F	E	P1	P0	D0	T1 max.	T2 max.	Mounting Hole
01005	0.25 ± 0.04	0.45 ± 0.04	8.0 ± 0.3	3.5 ± 0.05	1.75 ± 0.1	2.0 ± 0.05	4.0 ± 0.1	1.5 ^{+0.1} _{-0.0}	0.27	0.36	Angular Punch Hole
0201	0.37 ± 0.03	0.67 ± 0.05							0.45	0.80	
0402	0.65 ± 0.05	1.15 ± 0.05				4.0 ± 0.10			1.1	1.4	
0603	1.1 ± 0.2	1.9 ± 0.2									
0805	1.65 ± 0.2	2.4 ± 0.2									
1206	2.0 ± 0.2	3.6 ± 0.2									

PUNCHED CARRIER TAPE

