

## QUAD OPERATIONAL AMPLIFIER

### ■ GENERAL DESCRIPTION

NJM2112 is low operating voltage (  $\pm 1.0V$  min. ) and low saturation output voltage (  $\pm 2.0V_{P-P}$  at operating voltage  $\pm 2.5V$  ) operational amplifier. It is applicable to HANDY TYPE CD, RADIO CASSETTE CD, and PORTABLE DAT, that are digital audio apparatus which require the 5V single supply operation and high output voltage. The NJM2112 is quad operational amplifier. Each amplifier of the NJM2112 has the same electrical characteristic of the NJM2115.

### ■ PACKAGE OUTLINE

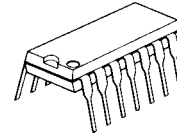

NJM2112D

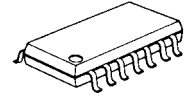

NJM2112M



NJM2112V

### ■ FEATURES

- Operating Voltage (  $\pm 1.0V \sim \pm 7.0V$  )
- Low Saturation Output Voltage (  $\pm 2.0V_{P-P}$  @  $V^+ = \pm 2.5V$  )
- Package Outline DIP14, DMP14, SSOP14
- Bipolar Technology

### ■ PIN CONFIGURATION

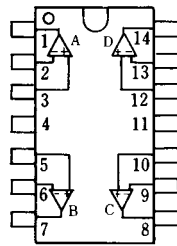

NJM2112D  
NJM2112M  
NJM2112V

### PIN FUNCTION

1. A OUTPUT
2. A -INPUT
3. A +INPUT
4.  $V^+$
5. B +INPUT
6. B -INPUT
7. B OUTPUT
8. C OUTPUT
9. C -INPUT
10. C +INPUT
11.  $V^-$
12. D +INPUT
13. D -INPUT
14. D OUTPUT

### ■ EQUIVALENT CIRCUIT ( 1/4 Shown )

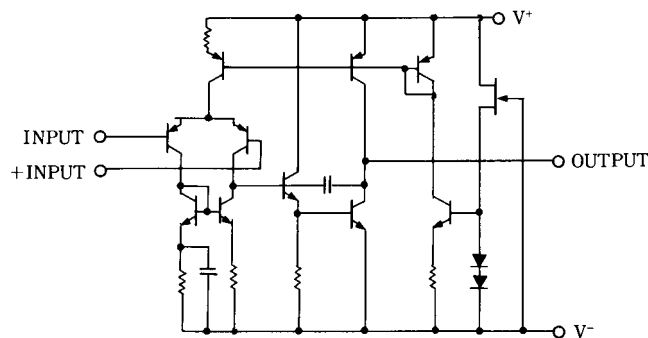

# NJM2112

## ■ ABSOLUTE MAXIMUM RATINGS

( Ta=25°C )

PARAMETER	SYMBOL	RATINGS	UNIT
Supply Voltage	$V^+V^-$	$\pm 7.0$	V
Differential Input Voltage	$V_{ID}$	$\pm 14$	V
Power Dissipation	$P_D$	( DIP14 ) 500 ( DMP14 ) 300 ( SSOP14 ) 300	mW
Operating Temperature Range	$T_{opr}$	-40~+85	°C
Storage Temperature Range	$T_{stg}$	-40~+125	°C

## ■ ELECTRICAL CHARACTERISTICS

(  $V^+V^-=\pm 2.5V, Ta=25^\circ C$  )

PARAMETER	SYMBOL	TEST CONDITION	MIN.	TYP.	MAX.	UNIT
Input Offset Voltage	$V_{IO}$	$R_S \leq 10k\Omega$	-	1	6	mV
Input Bias Current	$I_B$		-	100	300	nA
Large signal Voltage Gain	$A_V$	$R_L \geq 10k\Omega$	60	80	-	dB
Maximum Output Voltage Swing	$V_{OM}$	$R_L \geq 2.5k\Omega$	$\pm 2$	$\pm 2.2$	-	V
Input Common Mode Voltage Range	$V_{ICM}$		$\pm 1.5$	-	-	V
Common Mode Rejection Ratio	CMR		60	74	-	dB
Supply Voltage Rejection Ratio	SVR		60	80	-	dB
Operating Current	$I_{CC}$	$V_{IN}=0, R_L=\infty$	-	8	11	mA
Slew Rate	SR	$A_V=1, V_{IN}=\pm 1V$	-	3.2	-	V/ $\mu s$
Gain Bandwidth Product	GB	$f=10kHz$	-	9	-	MHz

( Note1 ) Applied circuit voltage gain is desired to be operated within the range of 3dB to 30 dB.

( Note2 ) Special care being required for input common mode voltage range and the oscillation due to the capacitive load when operating on voltage follower.

## ■ TYPICAL CHARACTERISTICS

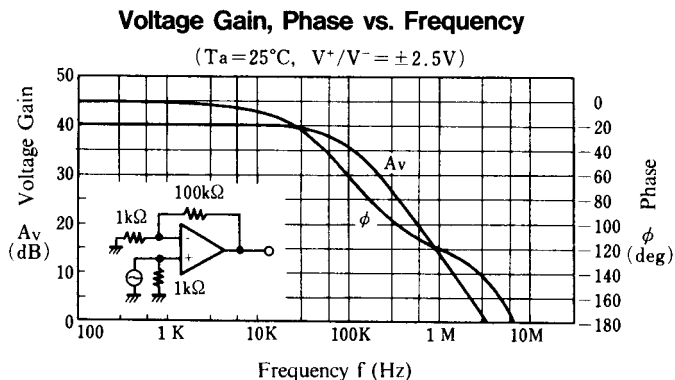

### Total Harmonic Distortion vs. Output Voltage

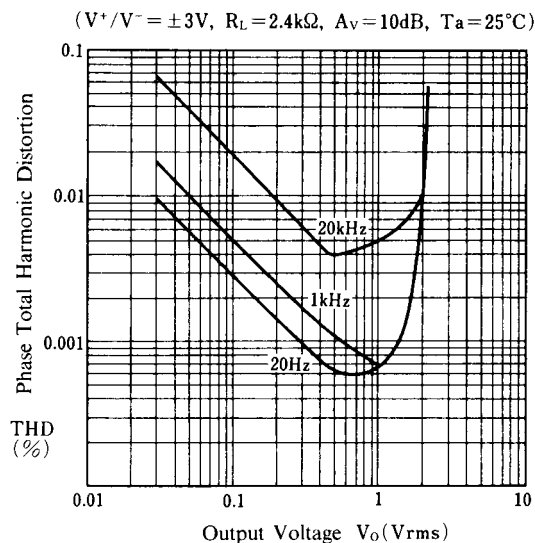

### Equivalent Input Noise Voltage vs. Source Resistance

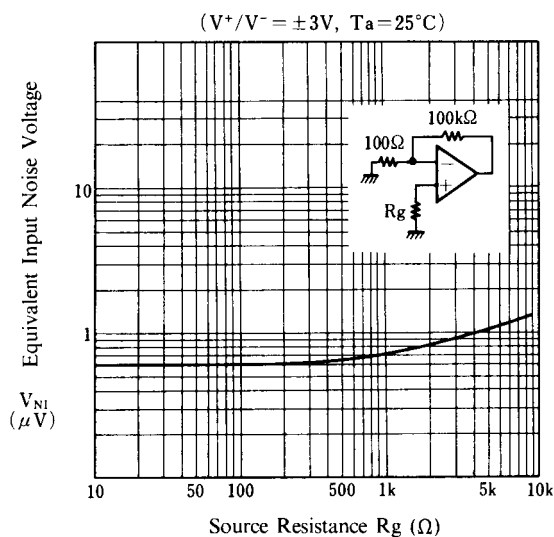

### Operating Current vs. Operating Voltage

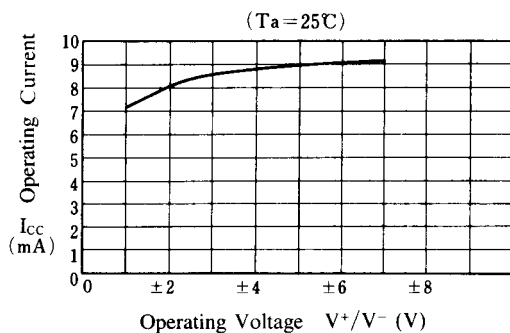

### Input Offset Voltage vs. Operating Voltage

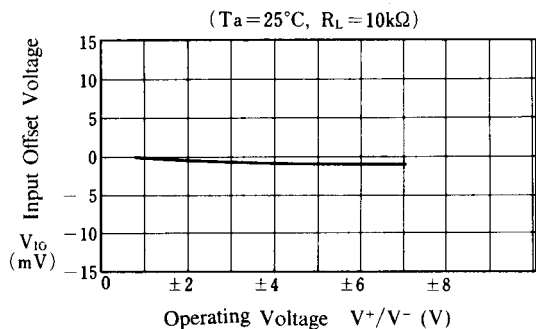

### Maximum Output Voltage Swing vs. Operating Voltage

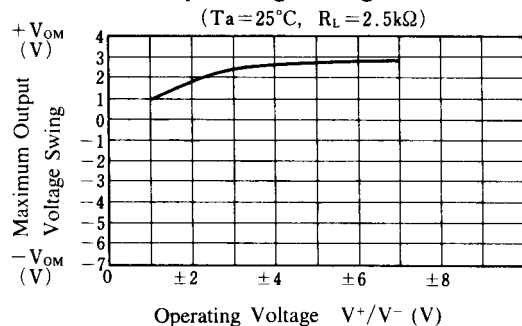

## ■ TYPICAL CHARACTERISTICS

**Input Bias Current vs. Operating Voltage**

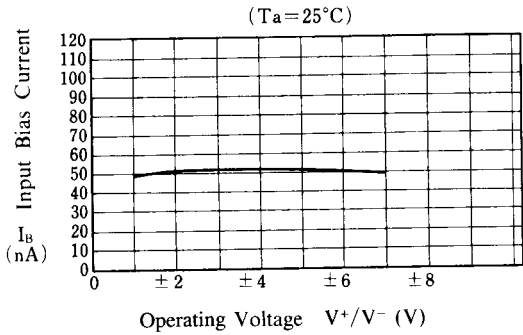

**Maximum Output Voltage Swing vs. Load Resistance**

( $V^+/V^- = \pm 2.5\text{V}$ ,  $T_a = 25^\circ\text{C}$ )

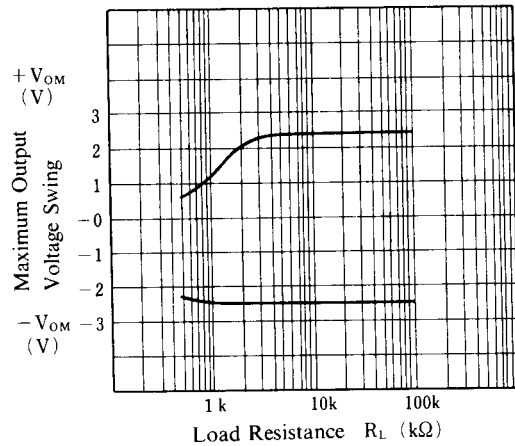

**Operating Current vs. Temperature**

( $V^+/V^- = \pm 2.5\text{V}$ )

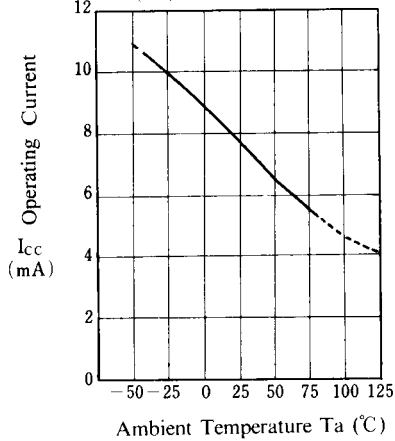

**Input Offset Voltage vs. Temperature**

( $V^+/V^- = \pm 2.5\text{V}$ ,  $R_L = 10\text{k}\Omega$ )

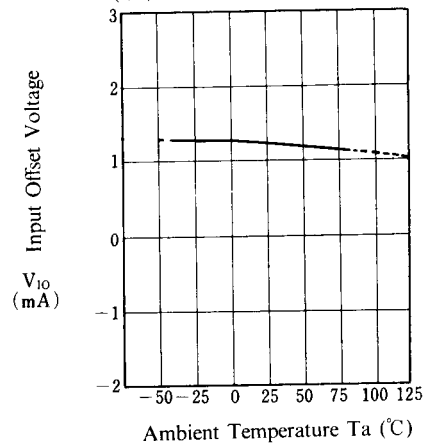

**Input Bias Current vs. Temperature**

( $V^+/V^- = \pm 2.5\text{V}$ )

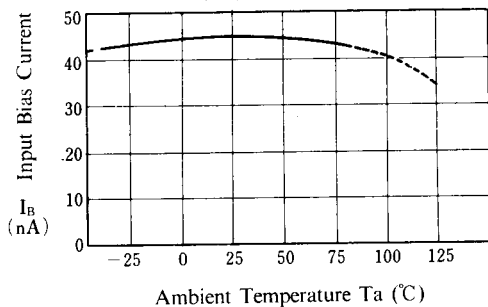

**Maximum Output Voltage Swing vs. Temperature**

( $V^+/V^- = \pm 2.5\text{V}$ ,  $R_L = 2.5\text{k}\Omega$ )

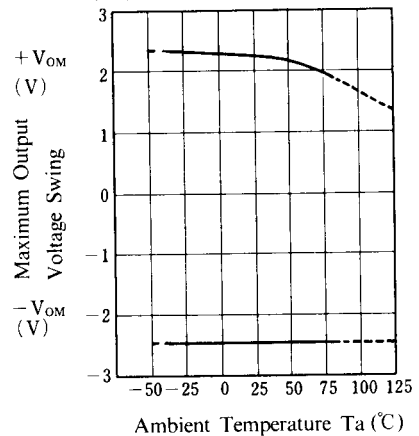

**[CAUTION]**

The specifications on this databook are only given for information, without any guarantee as regards either mistakes or omissions. The application circuits in this databook are described only to show representative usages of the product and not intended for the guarantee or permission of any right including the industrial rights.