

QUAD OPERATIONAL AMPLIFIER

■ GENERAL DESCRIPTION

The NJM2058 integrated circuit is a quad high-gain operational amplifier internally compensated and constructed on a single silicon chip using an advanced epitaxial process.

Each amplifier of the NJM2058 has the same electrical characteristics of the NJM4558.

■ FEATURES

- Operating Voltage ($\pm 4V \sim \pm 18V$)
- Package Outline DIP14, DMP14, SSOP14
- Bipolar Technology

■ PIN CONFIGURATION

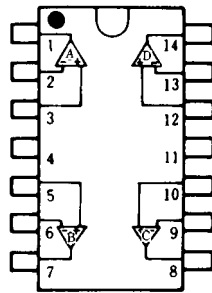

NJM2058D
NJM2058M
NJM2058V

■ PACKAGE OUTLINE

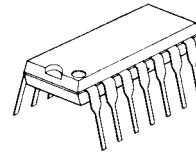

NJM2058D

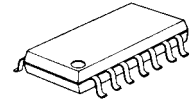

NJM2058M

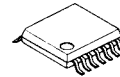

NJM2058V

PIN FUNCTION

1. A OUTPUT
2. A -INPUT
3. A +INPUT
4. V^+
5. B +INPUT
6. B -INPUT
7. B OUTPUT
8. C OUTPUT
9. C -INPUT
10. C +INPUT
11. V^-
12. D +INPUT
13. D -INPUT
14. D OUTPUT

■ EQUIVALENT CIRCUIT (1/4 Shown)

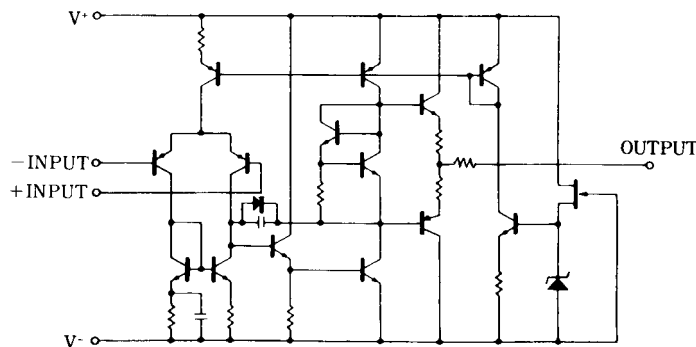

NJM2058

■ ABSOLUTE MAXIMUM RATINGS

(Ta=25°C)

PARAMETER	SYMBOL	RATINGS	UNIT
Supply Voltage	V^+ / V^-	± 18	V
Differential Input Voltage	V_{ID}	± 30	V
Input Voltage	V_{IC}	± 15 (note1)	V
Power Dissipation	P_D	(DIP14) 700 (DMP14) 700 (note2) (SSOP14) 300	mW
Operating Temperature Range	T_{opr}	-40~+85	°C
Storage Temperature Range	T_{stg}	-40~+125	°C

(note1) For supply voltage less than ±15V, the absolute maximum input voltage is equal to the supply voltage.

(note2) At on PC board

■ ELECTRICAL CHARACTERISTICS

(Ta=25°C, $V^+ / V^- = \pm 15V$)

PARAMETER	SYMBOL	TEST CONDITION	MIN.	TYP.	MAX.	UNIT
Input Offset Voltage	V_{IO}	$R_S \leq 10k\Omega$	-	0.5	6	mV
Input Offset Current	I_{IO}		-	5	200	nA
Input Bias Current	I_B		-	20	500	nA
Input Resistance	R_{IN}		0.3	1	-	MΩ
Large signal Voltage Gain	A_V	$R_L \geq 2k\Omega, V_O = \pm 10V$	86	100	-	dB
Maximum Output Voltage Swing 1	V_{OM1}	$R_L \geq 10k\Omega$	± 12	± 14	-	V
Maximum Output Voltage Swing 2	V_{OM2}	$R_L \geq 2k\Omega$	± 10	± 13	-	V
Input Common Mode Voltage Range	V_{ICM}		± 12	± 14	-	V
Common Mode Rejection Ratio	CMR	$R_S \leq 10k\Omega$	70	90	-	dB
Supply Voltage Rejection Ratio	SVR	$R_S \leq 10k\Omega$	76.5	90	-	dB
Operating Current	I_{CC}		-	7	11.3	mA
Slew Rate	SR		-	1	-	V/μs
Equivalent Input Noise Voltage	V_{NI}	RIAA, $R_S = 2.2k\Omega, 30kHz$ LPF	-	1.4	-	μVrms

■ TYPICAL CHARACTERISTICS

Equivalent Input Noise Voltage vs. Frequency

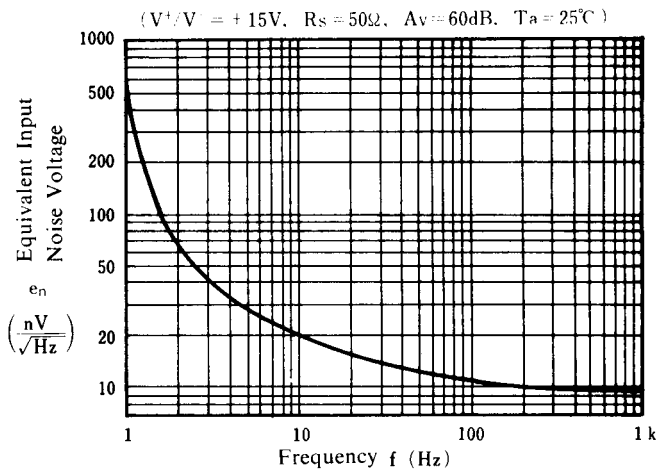

Open Loop Voltage Gain vs. Frequency

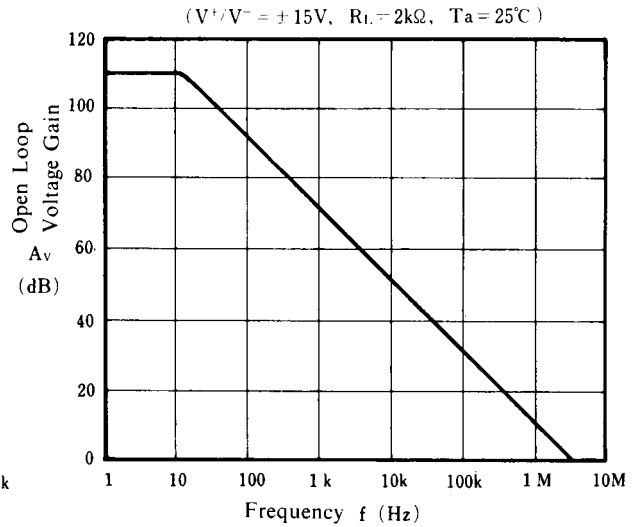

Maximum Output Voltage Swing vs. Frequency

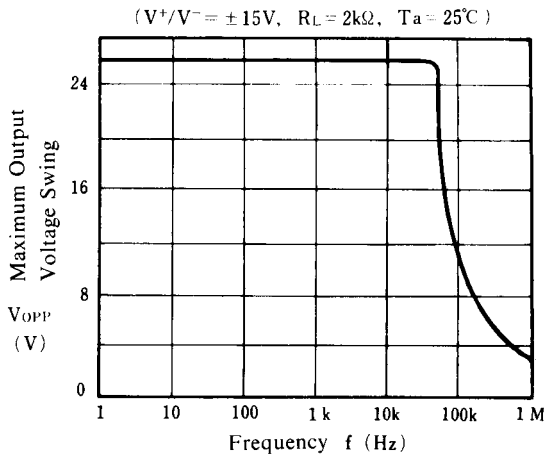

Maximum Output Voltage Swing vs. Load Resistance

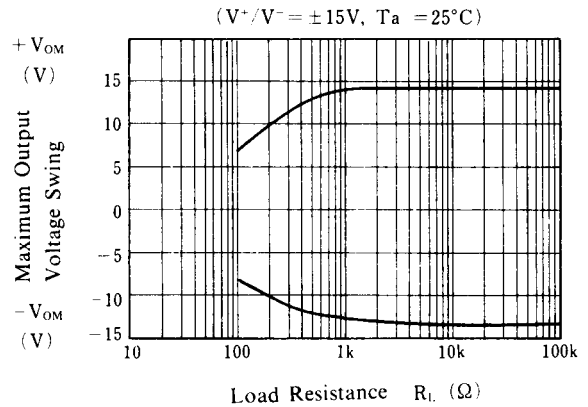

Operating Current vs. Temperature

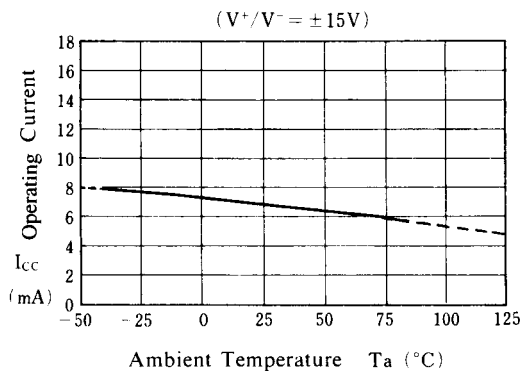

Maximum Output Voltage Swing vs. Temperature

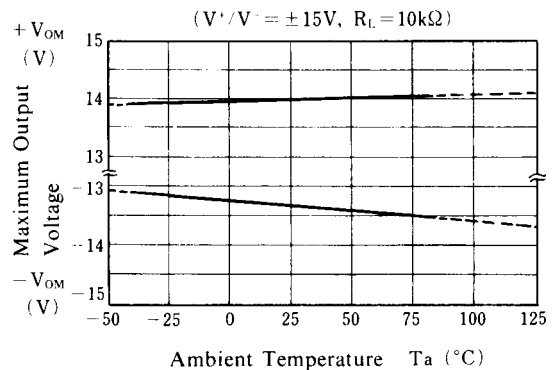

■ TYPICAL CHARACTERISTICS

Input Offset Voltage vs. Temperature

($V^+/V^- = \pm 15V$)

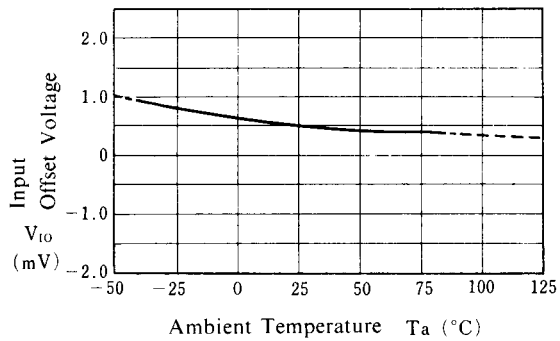

Input Bias Current vs. Temperature

($V^+/V^- = \pm 15V$)

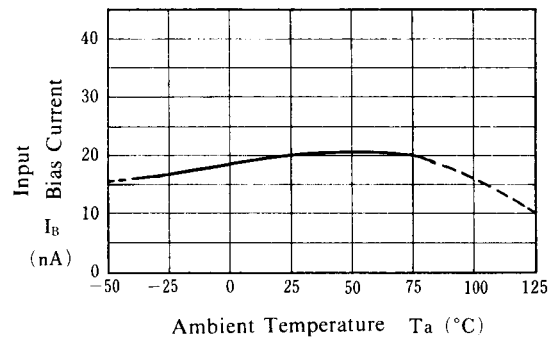

Operating Current vs. Operating Voltage

($T_a = 25^\circ C$)

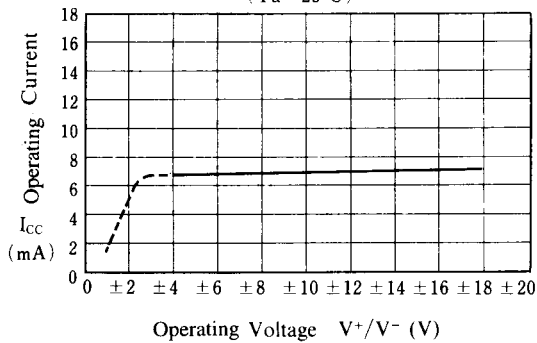

Maximum Output Voltage Swing vs. Operating Voltage

($R_L = 2k\Omega, T_a = 25^\circ C$)

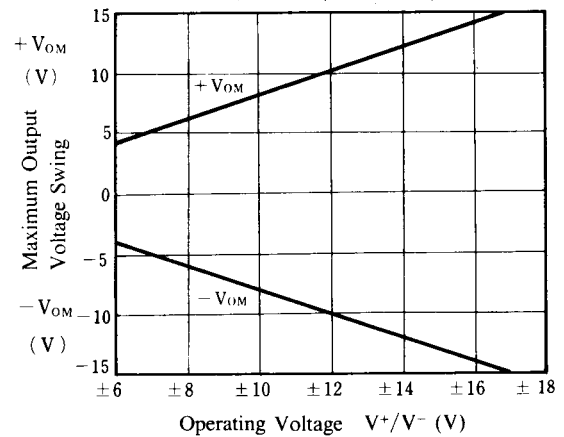

■ TYPICAL CHARACTERISTICS

Total Harmonic Distortion

($V^+/V^- = \pm 15V$, Gain=40dB, $R_L = 10k\Omega$,
 $T_a = 25^\circ C$)

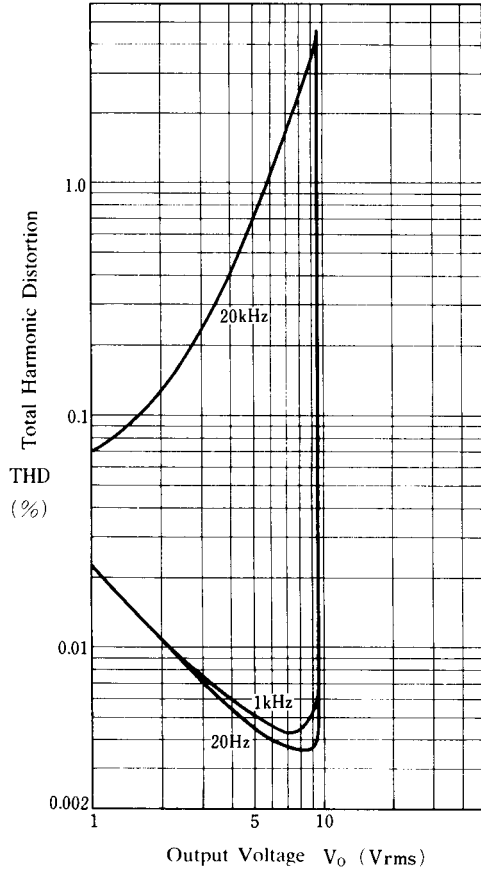

Total Harmonic Distortion

($V^+/V^- = \pm 15V$, Gain=40dB, $R_L = 2k\Omega$,
 $T_a = 25^\circ C$)

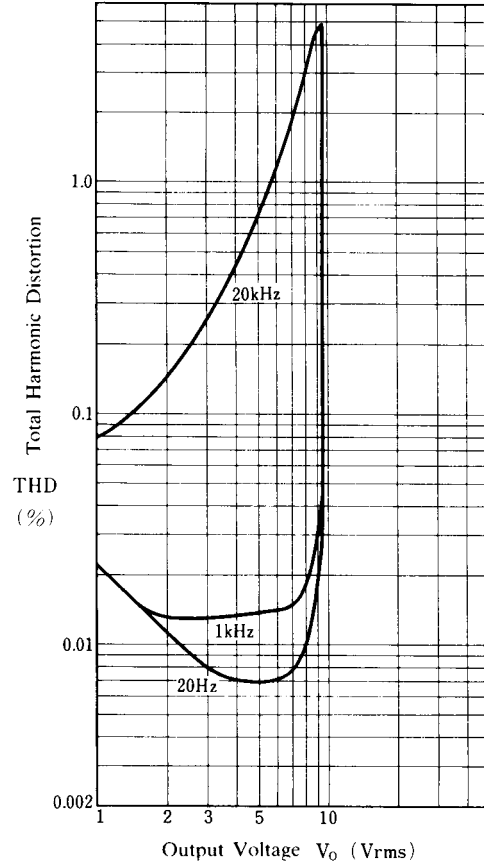

[CAUTION]

The specifications on this databook are only given for information, without any guarantee as regards either mistakes or omissions. The application circuits in this databook are described only to show representative usages of the product and not intended for the guarantee or permission of any right including the industrial rights.