

Protection, flexibility and safety

Cam switches from 10 to 63 A

► STANDARD SOLUTIONS P. 198 - 223

The expertise of a specialist like Baco allows us to offer custom solutions, even the most specific.



Choice of electrical configuration
from 1 to 24 contacts

Metal shaft
can withstand more than
1 million operations

**Customized
engravings**

► ADVANTAGES

- Conform to European and international standards: IEC, UL and CSA, and CCC
- A metal shaft capable of withstanding more than 1 million operations
- More than 50,000 different electrical diagrams available
- Many specific functions and special markings

MINI CAM SWITCHES

▶ $\phi 16/22$ mm single hole mounting

 Technical Info (p. 224)

GENERAL USE RATING 10A

IP65 standard



223501



223511











223525



223528

Mounting and Dimensions see pg 199

Function	General use rating - amps	Number of poles	Number of contacts	Positions	Part Number
ON/OFF	10	1	1		223501
	10	2	2		223502
	10	3	3		223503
	10	4	4		223504
CHANGEOVER WITHOUT "OFF"	10	1	2		223511
	10	2	4		223512
	10	3	6		223513
	10	4	8		223514
CHANGEOVER WITH "OFF"	10	1	2		223505
	10	2	4		223506
	10	3	6		223507
	10	4	8		223508
THREE WAY WITHOUT "OFF"	10	1	3		223515
	10	2	6		223516
	10	3	9		223517
THREE WAY WITH "OFF"	10	1	3		223521
	10	2	6		223522
	10	3	9		223523
FOUR WAY WITHOUT "OFF"	10	1	4		223525
	10	2	8		223526
AMMETER - 3 CTs WITH COMMON POINT Contact Configuration - 8151	10		6		223529
VOLTMETER - WITHOUT NEUTRAL Contact Configuration - 8351	10		4		223527
VOLTMETER - WITH NEUTRAL Contact Configuration - 8357	10		6		223528

MINI CAM SWITCHES

► Technical Specifications

Characteristics	Data
► Thermal current I _{th}	10 A
► Rated operating current I _e	
- in AC 21	10 A
- in AC 15	2.5 A
► Motor performance in AC-3	
- 3 x 230 V	1.8 kW
- 3 x 400 V	2.2 kW
► Motor performance in AC-23	
- 1 x 230 V	0.75 kW
- 1 x 400 V	1.1 kW
- 3 x 230 V	1.8 kW
- 3 x 400 V	3 kW
► Rated insulation voltage U _i (V)	500 V
► Rated operating current in DC-1	
L/R < 1ms	
- 24 V DC	10 A
- 40 V DC	6 A
- 60 V DC	2.5 A
- 110 V DC	0.7 A
- 220 V DC	0.3 A

Characteristics	Data
► Rated conditional short-circuit current	3 kA
► Max. fuse rating	10 A
► Degree of protection	IP 65 IP 2x at the rear of the panel
► Wire size (flexible and rigid)	2 x 1.5 mm ² max. 1 x 0.5 mm ² min.
► Operating temperature	- 20°C to + 50°C
► Standards	IEC/EN 60947-1 IEC/EN 60947-3 CSA 22.2 UL 508

Dimensions

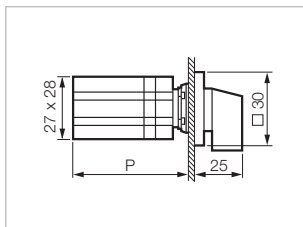

Dimensions in mm
 *P: 46 (1-2 CONTACTS)
 58 (3-4 CONTACTS)
 70 (5-6 CONTACTS)
 82 (7-8 CONTACTS)
 94 (9-10 CONTACTS)

Panel Thickness
 1 to 5.5mm

Mounting

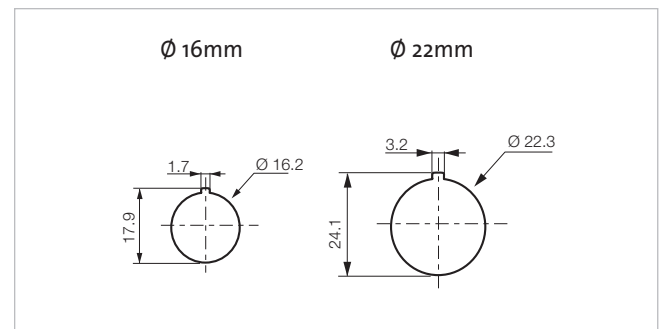

CAM SWITCHES

► Single Hole Mounting $\phi 22\text{mm}$

 Technical Info (p. 224)

GENERAL USE RATING 12A

IP40 standard - IP65 available upon request



HANDLE WITH LEGEND



HANDLE



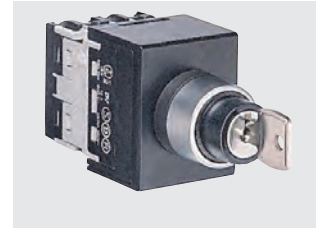

LEVER



KEY

Mounting and Dimensions see pg 226 to 229

Switch Series	Operator	Number of poles	Number of contacts	Positions	Designation	Part Number
PR12	HANDLE/LEGEND	1	1		PR12 1101 A4 E N48MD50	NB01AX80
PR12	HANDLE/LEGEND	2	2		PR12 1102 A4 E N48MD50	NB02AX80
PR12	HANDLE/LEGEND	3	3		PR12 1103 A4 E N48MD50	NB03AX80
PR12	HANDLE/LEGEND	4	4		PR12 1104 A4 E N48MD50	NB04AX80
PR12	HANDLE	1	1		PR12 1101 A4 E C21RA03	NB01AC113
PR12	HANDLE	2	2		PR12 1102 A4 E C21RA03	NB02AC113
PR12	HANDLE	3	3		PR12 1103 A4 E C21RA03	NB03AC113
PR12	HANDLE	4	4		PR12 1104 A4 E C21RA03	NB04AC113
PR12	LEVER	1	1		PR12 1101 A4 E C21RB03	NB01AC123
PR12	LEVER	2	2		PR12 1102 A4 E C21RB03	NB02AC123
PR12	LEVER	3	3		PR12 1103 A4 E C21RB03	NB03AC123
PR12	LEVER	4	4		PR12 1104 A4 E C21RB03	NB04AC123
PR12	KEY	1	1	Key Removable in both positions	PR12 1101 A4 E C21RC00	NB01AC1C1
PR12	KEY	2	2		PR12 1102 A4 E C21RC00	NB02AC1C1
PR12	KEY	3	3		PR12 1103 A4 E C21RC00	NB03AC1C1
PR12	KEY	4	4		PR12 1104 A4 E C21RC00	NB04AC1C1
PR12	HANDLE/LEGEND	1	2		PR12 2251 D4 E N48MD50	NC51DX80
PR12	HANDLE/LEGEND	2	4		PR12 2252 D4 E N48MD50	NC52DX80
PR12	HANDLE/LEGEND	3	6		PR12 2253 D4 E N48MD50	NC53DX80
PR12	HANDLE/LEGEND	4	8		PR12 2254 D4 E N48MD50	NC54DX80
PR12	HANDLE	1	2		PR12 2251 D4 E C21RA03	NC51DC113
PR12	HANDLE	2	4		PR12 2252 D4 E C21RA03	NC52DC113
PR12	HANDLE	3	6		PR12 2253 D4 E C21RA03	NC53DC113
PR12	HANDLE	4	8		PR12 2254 D4 E C21RA03	NC54DC113
PR12	LEVER	1	2		PR12 2251 D4 E C21RB03	NC51DC123
PR12	LEVER	2	4		PR12 2252 D4 E C21RB03	NC52DC123
PR12	LEVER	3	6		PR12 2253 D4 E C21RB03	NC53DC123
PR12	LEVER	4	8		PR12 2254 D4 E C21RB03	NC54DC123

CAM SWITCHES

► Single Hole Mounting $\varnothing 22\text{mm}$

 Technical Info (p. 224)

GENERAL USE RATING 12A

IP40 standard - IP65 available upon request



HANDLE WITH LEGEND



HANDLE





LEVER



KEY

Mounting and Dimensions see pg 226 to 229

Switch Series	Operator	Number of poles	Number of contacts	Positions	Designation	Part Number
PR12	HANDLE/LEGEND	1	2		PR12 2201 C8 E N48MD50	NC01GX80
PR12	HANDLE/LEGEND	2	4		PR12 2202 C8 E N48MD50	NC02GX80
PR12	HANDLE/LEGEND	3	6		PR12 2203 C8 E N48MD50	NC03GX80
PR12	HANDLE/LEGEND	4	8		PR12 2204 C8 E N48MD50	NC04GX80
PR12	HANDLE	1	2		PR12 2201 C8 E C21RA03	NC01GC113
PR12	HANDLE	2	4		PR12 2202 C8 E C21RA03	NC02GC113
PR12	HANDLE	3	6		PR12 2203 C8 E C21RA03	NC03GC113
PR12	HANDLE	4	8		PR12 2204 C8 E C21RA03	NC04GC113
PR12	LEVER	1	2		PR12 2201 C8 E C21RB03	NC01GC123
PR12	LEVER	2	4		PR12 2202 C8 E C21RB03	NC02GC123
PR12	LEVER	3	6		PR12 2203 C8 E C21RB03	NC03GC123
PR12	LEVER	4	8		PR12 2204 C8 E C21RB03	NC04GC123
PR12	KEY	1	2	Key Removable in position '0' only	PR12 2201 C8 E C21RC00	NC01GC1C1
PR12	KEY	2	4		PR12 2202 C8 E C21RC00	NC02GC1C1
PR12	KEY	3	6		PR12 2203 C8 E C21RC00	NC03GC1C1
PR12	KEY	4	8		PR12 2204 C8 E C21RC00	NC04GC1C1
PR12	HANDLE/LEGEND	1	3		PR12 2301 A4 E N48MD50	ND01AX80
PR12	HANDLE/LEGEND	2	6		PR12 2302 A4 E N48MD50	ND02AX80
PR12	HANDLE/LEGEND	3	9		PR12 2303 A4 E N48MD50	ND03AX80
PR12	HANDLE/LEGEND	4	12		PR12 2304 A4 E N48MD50	ND04AX80
PR12	HANDLE	1	3		PR12 2301 A4 E C21RA03	ND01AC113
PR12	HANDLE	2	6		PR12 2302 A4 E C21RA03	ND02AC113
PR12	HANDLE	3	9		PR12 2303 A4 E C21RA03	ND03AC113
PR12	HANDLE	4	12		PR12 2304 A4 E C21RA03	ND04AC113
PR12	LEVER	1	3		PR12 2301 A4 E C21RB03	ND01AC123
PR12	LEVER	2	6		PR12 2302 A4 E C21RB03	ND02AC123
PR12	LEVER	3	9		PR12 2303 A4 E C21RB03	ND03AC123
PR12	LEVER	4	12		PR12 2304 A4 E C21RB03	ND04AC123
PR12	KEY	1	3	Key Removable in all positions	PR12 2301 A4 E C21RC00	ND01AC1C1
PR12	KEY	2	6		PR12 2302 A4 E C21RC00	ND02AC1C1
PR12	KEY	3	9		PR12 2303 A4 E C21RC00	ND03AC1C1
PR12	KEY	4	12		PR12 2304 A4 E C21RC00	ND04AC1C1

CAM SWITCHES

▶ ON/OFF SWITCHES

 Technical Info (p. 224)

PANEL MOUNTING - TWO FIXING SCREWS

IP40 standard - IP65 available upon request

Contact Configuration

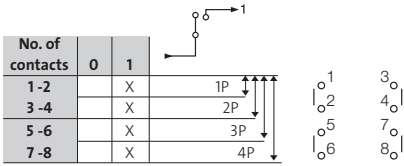

NB02AQ1



SB04AQ1

























Mounting and Dimensions see pg 226 to 229



ZB04AQ7



HB03AQ7

Switch Series	General use rating - amps	Number of poles	Number of contacts	Positions	Designation	Part Number
PR12	12	1	1		PR12 1101 A4 E Q48PN50	NB01AQ1
PR12	12	2	2		PR12 1102 A4 E Q48PN50	NB02AQ1
PR12	12	3	3		PR12 1103 A4 E Q48PN50	NB03AQ1
PR12	12	4	4		PR12 1104 A4 E Q48PN50	NB04AQ1
PR17	16	1	1		PR17 1101 A4 E Q48PN50	SB01AQ1
PR17	16	2	2		PR17 1102 A4 E Q48PN50	SB02AQ1
PR17	16	3	3		PR17 1103 A4 E Q48PN50	SB03AQ1
PR17	16	4	4		PR17 1104 A4 E Q48PN50	SB04AQ1
PR21	20	1	1		PR21 1101 A4 E Q48PN50	TB01AQ1
PR21	20	2	2		PR21 1102 A4 E Q48PN50	TB02AQ1
PR21	20	3	3		PR21 1103 A4 E Q48PN50	TB03AQ1
PR21	20	4	4		PR21 1104 A4 E Q48PN50	TB04AQ1
PR26	25	1	1		PR26 1101 A4 E Q72MN50	ZB01AQ7
PR26	25	2	2		PR26 1102 A4 E Q72MN50	ZB02AQ7
PR26	25	3	3		PR26 1103 A4 E Q72MN50	ZB03AQ7
PR26	25	4	4		PR26 1104 A4 E Q72MN50	ZB04AQ7
PR40	50	1	1		PR40 1101 A4 E Q72MN60	HB01AQ7
PR40	50	2	2		PR40 1102 A4 E Q72MN60	HB02AQ7
PR40	50	3	3		PR40 1103 A4 E Q72MN60	HB03AQ7
PR40	50	4	4		PR40 1104 A4 E Q72MN60	HB04AQ7
PR63	63	1	1		PR63 1101 A4 E Q72MN60	IB01AQ7
PR63	63	2	2		PR63 1102 A4 E Q72MN60	IB02AQ7
PR63	63	3	3		PR63 1103 A4 E Q72MN60	IB03AQ7
PR63	63	4	4		PR63 1104 A4 E Q72MN60	IB04AQ7

CAM SWITCHES

▶ ON/OFF SWITCHES

 Technical Info (p. 224)

IN ENCLOSURE

IP40 standard - IP65 available upon request

Contact Configuration

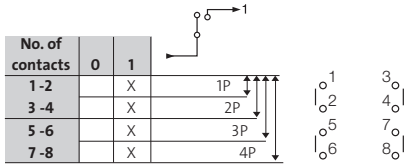

NB04AXQ



TB01AXQ



























ZB02AXQ



IB02AAQ

Mounting and Dimensions see pg 226 to 229

Switch Series	General use rating - amps	Number of poles	Number of contacts	Positions	Designation	Part Number
PR12	12	1	1		PR12 1101 A4 BCQ3	NB01AXQ
PR12	12	2	2		PR12 1102 A4 BCQ3	NB02AXQ
PR12	12	3	3		PR12 1103 A4 BCQ3	NB03AXQ
PR12	12	4	4		PR12 1104 A4 BCQ3	NB04AXQ
PR17	16	1	1		PR17 1101 A4 BCQ3	SB01AXQ
PR17	16	2	2		PR17 1102 A4 BCQ3	SB02AXQ
PR17	16	3	3		PR17 1103 A4 BCQ3	SB03AXQ
PR17	16	4	4		PR17 1104 A4 BCQ3	SB04AXQ
PR21	20	1	1		PR21 1101 A4 BCQ3	TB01AXQ
PR21	20	2	2		PR21 1102 A4 BCQ3	TB02AXQ
PR21	20	3	3		PR21 1103 A4 BCQ3	TB03AXQ
PR21	20	4	4		PR21 1104 A4 BCQ3	TB04AXQ
PR26	25	1	1		PR26 1101 A4 BCQ3	ZB01AXQ
PR26	25	2	2		PR26 1102 A4 BCQ3	ZB02AXQ
PR26	25	3	3		PR26 1103 A4 BCQ3	ZB03AXQ
PR26	25	4	4		PR26 1104 A4 BCQ3	ZB04AXQ
PR40	50	1	1		PR40 1101 A4 BCF Q72MN60	HB01AAQ
PR40	50	2	2		PR40 1102 A4 BCF Q72MN60	HB02AAQ
PR40	50	3	3		PR40 1103 A4 BCF Q72MN60	HB03ABQ
PR40	50	4	4		PR40 1104 A4 BCF Q72MN60	HB04ABQ
PR63	63	1	1		PR63 1101 A4 BCF Q72MN60	IB01AAQ
PR63	63	2	2		PR63 1102 A4 BCF Q72MN60	IB02AAQ
PR63	63	3	3		PR63 1103 A4 BCF Q72MN60	IB03ABQ
PR63	63	4	4		PR63 1104 A4 BCF Q72MN60	IB04ABQ

CAM SWITCHES

▶ ON/OFF “MAIN SWITCHES”



Technical Info (p. 224)

PANEL MOUNTING - TWO FIXING SCREWS

IP65 standard - IP40 available upon request

Contact Configuration - 1103GN

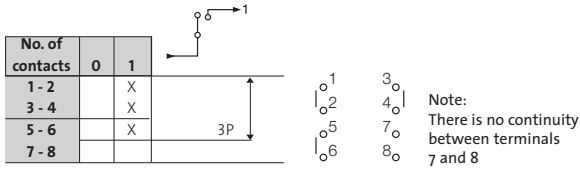

NS3EV493-IP65



TS3EV493-IP65

Contact Configuration - 1104GN

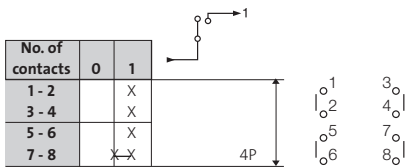

ZS3EV733-IP65



IS3EV733-IP65

Mounting and Dimensions see pg 226 to 229

Switch Series	General use rating - amps	Number of poles	Number of contacts	Positions	Designation	Part Number
PR12	12	3	3		PR12 1103 GN E J483PND51	NS3EV493-IP65
PR12	12	4	4		PR12 1104 GN E J483PND51	NS4EV493-IP65
PR17	16	3	3		PR17 1103 GN E J483PND51	SS3EV493-IP65
PR17	16	4	4		PR17 1104 GN E J483PND51	SS4EV493-IP65
PR21	20	3	3		PR21 1103 GN E J483PND51	TS3EV493-IP65
PR21	20	4	4		PR21 1104 GN E J483PND51	TS4EV493-IP65
PR26	25	3	3		PR26 1103 GN E J723MND51	ZS3EV733-IP65
PR26	25	4	4		PR26 1104 GN E J723MND51	ZS4EV733-IP65
PR40	50	3	3		PR40 1103 GN E J723MND61	HS3EV733-IP65
PR40	50	4	4		PR40 1104 GN E J723MND61	HS4EV733-IP65
PR63	63	3	3		PR40 1103 GN E J723MND61	IS3EV733-IP65
PR63	63	4	4		PR40 1104 GN E J723MND61	IS4EV733-IP65

CAM SWITCHES

▶ ON/OFF “MAIN SWITCHES”

 Technical Info (p. 224)

IN ENCLOSURE

IP65 standard - IP40 available upon request

Contact Configuration - 1103GN

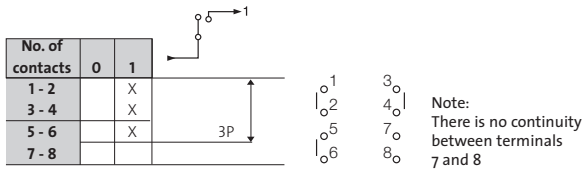

NS3XV483-IP65



SS3XV483-IP65

Contact Configuration - 1104GN

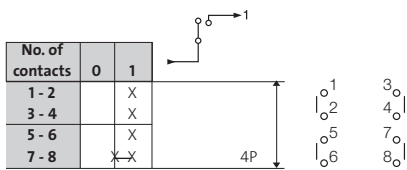













ZS3XV483-IP65



HS3BV733-IP65

Mounting and Dimensions see pg 226 to 229

Switch Series	General use rating - amps	Number of poles	Number of contacts	Positions	Designation	Part Number
PR12	12	3	3		PR12 1103 GN BC J48PND51	NS3XV483-IP65
PR12	12	4	4		PR12 1104 GN BC J48PND51	NS4XV483-IP65
PR17	16	3	3		PR17 1103 GN BC J48PND51	SS3XV483-IP65
PR17	16	4	4		PR17 1104 GN BC J48PND51	SS4XV483-IP65
PR21	20	3	3		PR21 1103 GN BC J48PND51	TS3XV483-IP65
PR21	20	4	4		PR21 1104 GN BC J48PND51	TS4XV483-IP65
PR26	25	3	3		PR26 1103 GN BC J48PND51	ZS3XV483-IP65
PR26	25	4	4		PR26 1104 GN BC J48PND51	ZS4XV483-IP65
PR40	50	3	3		PR40 1103 GN BCF J723MND61	HS3BV733-IP65
PR40	50	4	4		PR40 1104 GN BCF J723MND61	HS4BV733-IP65
PR63	63	3	3		PR40 1103 GN BCF J723MND61	IS3BV733-IP65
PR63	63	4	4		PR40 1104 GN BCF J723MND61	IS4BV733-IP65

CAM SWITCHES

▶ CHANGEOVER SWITCHES - WITHOUT OFF

 Technical Info (p. 224)

PANEL MOUNTING - TWO FIXING SCREWS

IP40 standard - IP65 available upon request

Contact Configuration

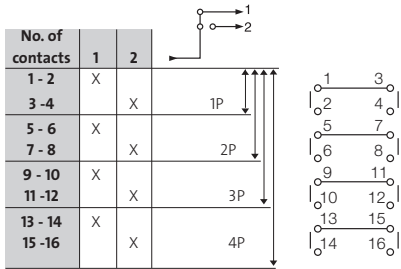

NCS5DQ1



TC51DQ1



























ZC52DQ7



HC52DQ7

Mounting and Dimensions see pg 226 to 229

Switch Series	General use rating - amps	Number of poles	Number of contacts	Positions	Designation	Part Number
PR12	12	1	2		PR12 2251 D4 E Q48PN50	NC51DQ1
PR12	12	2	4		PR12 2252 D4 E Q48PN50	NC52DQ1
PR12	12	3	6		PR12 2253 D4 E Q48PN50	NC53DQ1
PR12	12	4	8		PR12 2254 D4 E Q48PN50	NC54DQ1
PR17	16	1	2		PR17 2251 D4 E Q48PN50	SC51DQ1
PR17	16	2	4		PR17 2252 D4 E Q48PN50	SC52DQ1
PR17	16	3	6		PR17 2253 D4 E Q48PN50	SC53DQ1
PR17	16	4	8		PR17 2254 D4 E Q48PN50	SC54DQ1
PR21	20	1	2		PR21 2251 D4 E Q48PN50	TC51DQ1
PR21	20	2	4		PR21 2252 D4 E Q48PN50	TC52DQ1
PR21	20	3	6		PR21 2253 D4 E Q48PN50	TC53DQ1
PR21	20	4	8		PR21 2254 D4 E Q48PN50	TC54DQ1
PR26	25	1	2		PR26 2251 D4 E Q72MN50	ZC51DQ7
PR26	25	2	4		PR26 2252 D4 E Q72MN50	ZC52DQ7
PR26	25	3	6		PR26 2253 D4 E Q72MN50	ZC53DQ7
PR26	25	4	8		PR26 2254 D4 E Q72MN50	ZC54DQ7
PR40	50	1	2		PR40 2251 D4 E Q72MN60	HC51DQ7
PR40	50	2	4		PR40 2252 D4 E Q72MN60	HC52DQ7
PR40	50	3	6		PR40 2253 D4 E Q72MN60	HC53DQ7
PR40	50	4	8		PR40 2254 D4 E Q72MN60	HC54DQ7
PR63	63	1	2		PR63 2251 D4 E Q72MN60	IC51DQ7
PR63	63	2	4		PR63 2252 D4 E Q72MN60	IC52DQ7
PR63	63	3	6		PR63 2253 D4 E Q72MN60	IC53DQ7
PR63	63	4	8		PR63 2254 D4 E Q72MN60	IC54DQ7

CAM SWITCHES

▶ CHANGEOVER SWITCHES - WITHOUT OFF

 Technical Info (p. 224)

IN ENCLOSURE

IP40 standard - IP65 available upon request

Contact Configuration

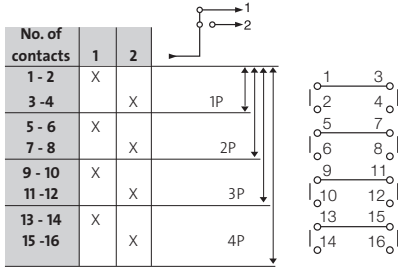

NC51DXQ



SC53DXQ









ZC52DXQ



IC52DBQ

Mounting and Dimensions see pg 226 to 229

Switch Series	General use rating - amps	Number of poles	Number of contacts	Positions	Designation	Part Number
PR12	12	1	2		PR12 2251 D4 BCQ3	NC51DXQ
PR12	12	2	4		PR12 2252 D4 BCQ3	NC52DXQ
PR12	12	3	6		PR12 2253 D4 BCQ3	NC53DXQ
PR12	12	4	8		PR12 2254 D4 BCQ3	NC54DXQ
PR17	16	1	2		PR17 2251 D4 BCQ3	SC51DXQ
PR17	16	2	4		PR17 2252 D4 BCQ3	SC52DXQ
PR17	16	3	6		PR17 2253 D4 BCQ3	SC53DXQ
PR17	16	4	8		PR17 2254 D4 BCQ3	SC54DXQ
PR21	20	1	2		PR21 2251 D4 BCQ3	TC51DXQ
PR21	20	2	4		PR21 2252 D4 BCQ3	TC52DXQ
PR21	20	3	6		PR21 2253 D4 BCQ3	TC53DXQ
PR21	20	4	8		PR21 2254 D4 BCQ3	TC54DXQ
PR26	25	1	2		PR26 2251 D4 BCQ3	ZC51DXQ
PR26	25	2	4		PR26 2252 D4 BCQ3	ZC52DXQ
PR26	25	3	6		PR26 2253 D4 BCQ3	ZC53DXQ
PR26	25	4	8		PR26 2254 D4 BCQ3	ZC54DXQ
PR40	50	1	2		PR40 2251 D4 BCF Q72MN60	HC51DAQ
PR40	50	2	4		PR40 2252 D4 BCF Q72MN60	HC52DBQ
PR40	50	3	6		PR40 2253 D4 BCF Q72MN60	HC53DCQ
PR40	50	4	8		PR40 2254 D4 BCF Q72MN60	HC54DDQ
PR63	63	1	2		PR63 2251 D4 BCF Q72MN60	IC51DAQ
PR63	63	2	4		PR63 2252 D4 BCF Q72MN60	IC52DBQ
PR63	63	3	6		PR63 2253 D4 BCF Q72MN60	IC53DCQ
PR63	63	4	8		PR63 2254 D4 BCF Q72MN60	IC54DDQ

CAM SWITCHES

▶ CHANGEOVER SWITCHES - WITH OFF

 Technical Info (p. 224)

PANEL MOUNTING - TWO FIXING SCREWS

IP40 standard - IP65 available upon request

Contact Configuration

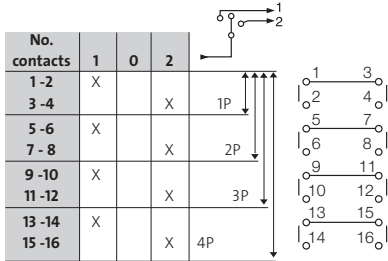

NC02GQ1



SC04GQ1



























ZC02GQ7



HC03Q7

Mounting and Dimensions see pg 226 to 229

Switch Series	General use rating - amps	Number of poles	Number of contacts	Positions	Designation	Part Number
PR12	12	1	2		PR12 2201 C8 E Q48PN50	NC01GQ1
PR12	12	2	4		PR12 2202 C8 E Q48PN50	NC02GQ1
PR12	12	3	6		PR12 2203 C8 E Q48PN50	NC03GQ1
PR12	12	4	8		PR12 2204 C8 E Q48PN50	NC04GQ1
PR17	16	1	2		PR17 2201 C8 E Q48PN50	SC01GQ1
PR17	16	2	4		PR17 2202 C8 E Q48PN50	SC02GQ1
PR17	16	3	6		PR17 2203 C8 E Q48PN50	SC03GQ1
PR17	16	4	8		PR17 2204 C8 E Q48PN50	SC04GQ1
PR21	20	1	2		PR21 2201 C8 E Q48PN50	TC01GQ1
PR21	20	2	4		PR21 2202 C8 E Q48PN50	TC02GQ1
PR21	20	3	6		PR21 2203 C8 E Q48PN50	TC03GQ1
PR21	20	4	8		PR21 2204 C8 E Q48PN50	TC04GQ1
PR26	25	1	2		PR26 2201 C8 E Q72MN50	ZC01GQ7
PR26	25	2	4		PR26 2202 C8 E Q72MN50	ZC02GQ7
PR26	25	3	6		PR26 2203 C8 E Q72MN50	ZC03GQ7
PR26	25	4	8		PR26 2204 C8 E Q72MN50	ZC04GQ7
PR40	50	1	2		PR40 2201 C8 E Q72MN60	HC01GQ7
PR40	50	2	4		PR40 2202 C8 E Q72MN60	HC02GQ7
PR40	50	3	6		PR40 2203 C8 E Q72MN60	HC03GQ7
PR40	50	4	8		PR40 2204 C8 E Q72MN60	HC04GQ7
PR63	63	1	2		PR63 2201 C8 E Q72MN60	IC01GQ7
PR63	63	2	4		PR63 2202 C8 E Q72MN60	IC02GQ7
PR63	63	3	6		PR63 2203 C8 E Q72MN60	IC03GQ7
PR63	63	4	8		PR63 2204 C8 E Q72MN60	IC04GQ7

CAM SWITCHES

▶ CHANGEOVER SWITCHES - WITH OFF

 Technical Info (p. 224)

IN ENCLOSURE

IP40 standard - IP65 available upon request

Contact Configuration

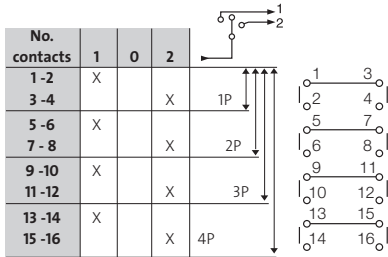

NC02GXQ



TC03GXQ



ZC04GXQ



IC02GBQ

Mounting and Dimensions see pg 226 to 229

Switch Series	General use rating - amps	Number of poles	Number of contacts	Positions	Designation	Part Number
PR12	12	1	2		PR12 2201 C8 BCQ3	NC01GXQ
PR12	12	2	4		PR12 2202 C8 BCQ3	NC02GXQ
PR12	12	3	6		PR12 2203 C8 BCQ3	NC03GXQ
PR12	12	4	8		PR12 2204 C8 BCQ3	NC04GXQ
PR17	16	1	2		PR17 2201 C8 BCQ3	SC01GXQ
PR17	16	2	4		PR17 2202 C8 BCQ3	SC02GXQ
PR17	16	3	6		PR17 2203 C8 BCQ3	SC03GXQ
PR17	16	4	8		PR17 2204 C8 BCQ3	SC04GXQ
PR21	20	1	2		PR21 2201 C8 BCQ3	TC01GXQ
PR21	20	2	4		PR21 2202 C8 BCQ3	TC02GXQ
PR21	20	3	6		PR21 2203 C8 BCQ3	TC03GXQ
PR21	20	4	8		PR21 2204 C8 BCQ3	TC04GXQ
PR26	25	1	2		PR26 2201 C8 BCQ3	ZC01GXQ
PR26	25	2	4		PR26 2202 C8 BCQ3	ZC02GXQ
PR26	25	3	6		PR26 2203 C8 BCQ3	ZC03GXQ
PR26	25	4	8		PR26 2204 C8 BCQ3	ZC04GXQ
PR40	50	1	2		PR40 2201 C8 BCF Q72MN60	HC01GAQ
PR40	50	2	4		PR40 2202 C8 BCF Q72MN60	HC02GBQ
PR40	50	3	6		PR40 2203 C8 BCF Q72MN60	HC03GCQ
PR40	50	4	8		PR40 2204 C8 BCF Q72MN60	HC04GDQ
PR63	63	1	2		PR63 2201 C8 BCF Q72MN60	IC01GAQ
PR63	63	2	4		PR63 2202 C8 BCF Q72MN60	IC02GBQ
PR63	63	3	6		PR63 2203 C8 BCF Q72MN60	IC03GCQ
PR63	63	4	8		PR63 2204 C8 BCF Q72MN60	IC04GDQ

CAM SWITCHES

▶ THREE WAY SWITCHES - WITH OFF

 Technical Info (p. 224)

PANEL MOUNTING - TWO FIXING SCREWS

IP40 standard - IP65 available upon request

Contact Configuration

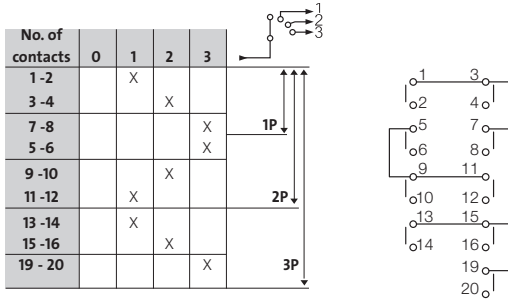

ND03AQ1



SD03AQ1









ZD02AQ7



HD02AQ7

Mounting and Dimensions see pg 226 to 229

Switch Series	General use rating - amps	Number of poles	Number of contacts	Positions	Designation	Part Number
PR12	12	1	3		PR12 2301 A4 E Q48PN50	ND01AQ1
PR12	12	2	6		PR12 2302 A4 E Q48PN50	ND02AQ1
PR12	12	3	9		PR12 2303 A4 E Q48PN50	ND03AQ1
PR17	16	1	3		PR17 2301 A4 E Q48PN50	SD01AQ1
PR17	16	2	6		PR17 2302 A4 E Q48PN50	SD02AQ1
PR17	16	3	9		PR17 2303 A4 E Q48PN50	SD03AQ1
PR21	20	1	3		PR21 2301 A4 E Q48PN50	TD01AQ1
PR21	20	2	6		PR21 2302 A4 E Q48PN50	TD02AQ1
PR21	20	3	9		PR21 2303 A4 E Q48PN50	TD03AQ1
PR26	25	1	3		PR26 2301 A4 E Q72MN50	ZD01AQ7
PR26	25	2	6		PR26 2302 A4 E Q72MN50	ZD02AQ7
PR26	25	3	9		PR26 2303 A4 E Q72MN50	ZD03AQ7
PR40	50	1	3		PR40 2301 A4 E Q72MN60	HD01AQ7
PR40	50	2	6		PR40 2302 A4 E Q72MN60	HD02AQ7
PR40	50	3	9		PR40 2303 A4 E Q72MN60	HD03AQ7
PR63	63	1	3		PR63 2301 A4 E Q72MN60	ID01AQ7
PR63	63	2	6		PR63 2302 A4 E Q72MN60	ID02AQ7
PR63	63	3	9		PR63 2303 A4 E Q72MN60	ID03AQ7

CAM SWITCHES

▶ THREE WAY SWITCHES - WITH OFF

 Technical Info (p. 224)

IN ENCLOSURE

IP40 standard - IP65 available upon request

Contact Configuration

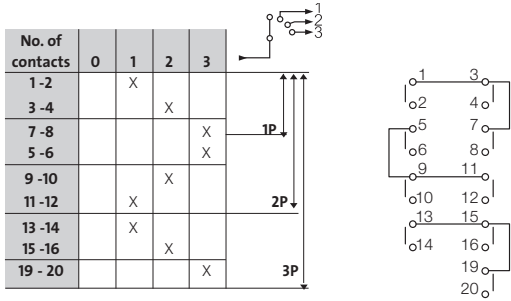

Mounting and Dimensions see pg 226 to 229



ND02AXQ

















TD01AXQ



ZD01AXQ



HD01ABQ

Switch Series	General use rating - amps	Number of poles	Number of contacts	Positions	Designation	Part Number
PR12	12	1	3		PR12 2301 A4 BCQ3	ND01AXQ
PR12	12	2	6		PR12 2302 A4 BCQ3	ND02AXQ
PR12	12	3	9		PR12 2303 A4 BCQ3	ND03AXQ
PR17	16	1	3		PR17 2301 A4 BCQ3	SD01AXQ
PR17	16	2	6		PR17 2302 A4 BCQ3	SD02AXQ
PR17	16	3	9		PR17 2303 A4 BCQ3	SD03AXQ
PR21	20	1	3		PR21 2301 A4 BCQ3	TD01AXQ
PR21	20	2	6		PR21 2302 A4 BCQ3	TD02AXQ
PR21	20	3	9		PR21 2303 A4 BCQ3	TD03AXQ
PR26	25	1	3		PR26 2301 A4 BCQ3	ZD01AXQ
PR26	25	2	6		PR26 2302 A4 BCQ3	ZD02AXQ
PR40	50	1	3		PR40 2301 A4 BCF Q72MN60	HD01ABQ
PR40	50	2	6		PR40 2302 A4 BCF Q72MN60	HD02ACQ
PR63	63	1	3		PR63 2301 A4 BCF Q72MN60	ID01ABQ
PR63	63	2	6		PR63 2302 A4 BCF Q72MN60	ID02ACQ

CAM SWITCHES

▶ 3 PHASE MOTOR SWITCH, FORWARD/OFF/REVERSE

 Technical Info (p. 224)

PANEL MOUNTING - TWO FIXING SCREWS

IP40 standard - IP65 available upon request

Contact Configuration - 9151

No. of contacts	REV	0	FWD
1-2	X		
3-4			X
5-6			X
7-8	X		
9-10	X		X

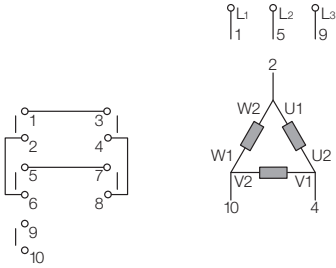

NZ11GQ1



TZ11GQ1









ZZ11GQ7



IZ11GQ7

Mounting and Dimensions see pg 226 to 229

Switch Series	General use rating - amps	Number of contacts	Positions	Designation	Part Number
PR12	12	5		PR12 9151 C8 E Q48PN50	NZ11GQ1
PR17	16	5		PR17 9151 C8 E Q48PN50	SZ11GQ1
PR21	20	5		PR21 9151 C8 E Q48PN50	TZ11GQ1
PR26	25	5		PR26 9151 C8 E Q72MN50	ZZ11GQ7
PR40	50	5		PR40 9151 C8 E Q72MN60	HZ11GQ7
PR63	63	5		PR63 9151 C8 E Q72MN60	IZ11GQ7

CAM SWITCHES

▶ 3 PHASE MOTOR SWITCH, FORWARD/OFF/REVERSE

 Technical Info (p. 224)

IN ENCLOSURE

IP40 standard - IP65 available upon request

Contact Configuration - 9151

No. of contacts	REV	0	FWD
1-2	X		
3-4			X
5-6			X
7-8	X		
9-10	X		X

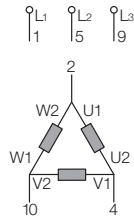
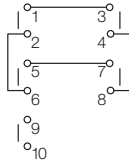

NZ11GXQ



SZ11GXQ









ZZ11GXQ



HZ11GCQ

Mounting and Dimensions see pg 226 to 229

Switch Series	General use rating - amps	Number of contacts	Positions	Designation	Part Number
PR12	12	5		PR12 9151 C8 BCQ3	NZ11GXQ
PR17	16	5		PR17 9151 C8 BCQ3	SZ11GXQ
PR21	20	5		PR21 9151 C8 BCQ3	TZ11GXQ
PR26	25	5		PR26 9151 C8 BCQ3	ZZ11GXQ
PR40	50	5		PR40 9151 C8 BCF Q72MN60	HZ11GCQ
PR63	63	5		PR63 9151 C8 BCF Q72MN60	IZ11GCQ

CAM SWITCHES

▶ 1 SPEED STARTER, FORWARD/OFF/REVERSE - 3 PHASE MOTOR

 Technical Info (p. 224)

PANEL MOUNTING - TWO FIXING SCREWS

IP40 standard - IP65 available upon request

Contact Configuration - 9153

No. of contacts	REV			FWD	
	Δ	Y	0	Y	Δ
1 - 2				X	X
3 - 4	X	X			
5 - 6	X	X			
7 - 8			X	X	
9 - 10	X				X
11 - 12	X				X
13 - 14		X		X	
15 - 16		X		X	
17 - 18	X				X
19 - 20	X	X		X	X

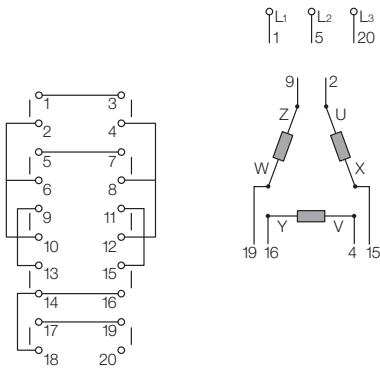

NZ13GQ1



TZ13GQ1









ZZ13GQ7



IZ13GQ7

Mounting and Dimensions see pg 226 to 229

Switch Series	General use rating - amps	Number of contacts	Positions	Designation	Part Number
PR12	12	10		PR12 9153 C8 E Q48PN50	NZ13GQ1
PR17	16	10		PR17 9153 C8 E Q48PN50	SZ13GQ1
PR21	20	10		PR21 9153 C8 E Q48PN50	TZ13GQ1
PR26	25	10		PR26 9153 C8 E Q72MN50	ZZ13GQ7
PR40	50	10		PR40 9153 C8 E Q72MN60	HZ13GQ7
PR63	63	10		PR63 9153 C8 E Q72MN60	IZ13GQ7

CAM SWITCHES

▶ 1 SPEED STARTER, FORWARD/OFF/REVERSE - 3 PHASE MOTOR

 Technical Info (p. 224)

IN ENCLOSURE

IP40 standard - IP65 available upon request

Contact Configuration - 9153

No. of contacts	REV			FWD	
	Δ	Y	0	Y	Δ
1 - 2				X	X
3 - 4	X	X			
5 - 6	X	X			
7 - 8				X	X
9 - 10	X				X
11 - 12	X				X
13 - 14		X		X	
15 - 16		X		X	
17 - 18	X				X
19 - 20	X	X		X	X

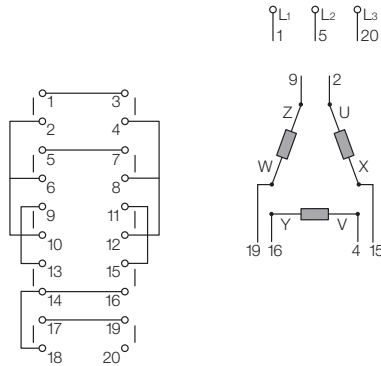

NZ13GXQ





SZ13GXQ



TZ13GXQ

Mounting and Dimensions see pg 226 to 229

Switch Series	General use rating - amps	Number of contacts	Positions	Designation	Part Number
PR12	12	10		PR12 9153 C8 BCQ3	NZ13GXQ
PR17	16	10		PR17 9153 C8 BCQ3	SZ13GXQ
PR21	20	10		PR21 9153 C8 BCQ3	TZ13GXQ

CAM SWITCHES

▶ 1 SPEED STARTER, 1WAY - 3 PHASE MOTOR

 Technical Info (p. 224)

PANEL MOUNTING - TWO FIXING SCREWS

IP40 standard - IP65 available upon request

Contact Configuration - 9551

No. of contacts	0	Y	Δ
1 - 2		X	X
3 - 4			X
5 - 6	X	X	
7 - 8	X	X	
9 - 10			X
11 - 12			X
13 - 14		X	X
15 - 16		X	X

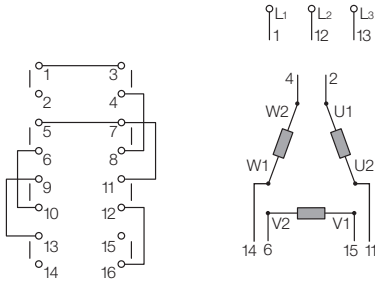

NZ51BQ1



TZ51BQ1









ZZ51BQ7



HZ51BQ7

Mounting and Dimensions see pg 226 to 229

Switch Series	General use rating - amps	Number of contacts	Positions	Designation	Part Number
PR12	12	8		PR12 9551 B4 E Q48PN50	NZ51BQ1
PR17	16	8		PR17 9551 B4 E Q48PN50	SZ51BQ1
PR21	20	8		PR21 9551 B4 E Q48PN50	TZ51BQ1
PR26	25	8		PR26 9551 B4 E Q72MN50	ZZ51BQ7
PR40	50	8		PR40 9551 B4 E Q72MN60	HZ51BQ7
PR63	63	8		PR63 9551 B4 E Q72MN60	IZ51BQ7

CAM SWITCHES

▶ 1 SPEED STARTER, 1WAY - 3 PHASE MOTOR

 Technical Info (p. 224)

IN ENCLOSURE

IP40 standard - IP65 available upon request

Contact Configuration - 9551

No. of contacts	0	Y	Δ
1 - 2		X	X
3 - 4			X
5 - 6	X	X	
7 - 8	X	X	
9 - 10			X
11 - 12			X
13 - 14	X	X	
15 - 16	X	X	

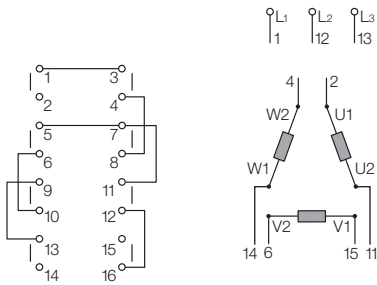

NZ51BXQ



SZ51BXQ









ZZ51BXQ



HZ51BDQ

Mounting and Dimensions see pg 226 to 229

Switch Series	General use rating - amps	Number of contacts	Positions	Designation	Part Number
PR12	12	8		PR12 9551 B4 BCQ3	NZ51BXQ
PR17	16	8		PR17 9551 B4 BCQ3	SZ51BXQ
PR21	20	8		PR21 9551 B4 BCQ3	TZ51BXQ
PR26	25	8		PR26 9551 B4 BCQ3	ZZ51BXQ
PR40	50	8		PR40 9551 B4 BCF Q72MN60	HZ51BDQ
PR63	63	8		PR63 9551 B4 BCF Q72MN60	IZ51BDQ

CAM SWITCHES

▶ 2 SPEEDS, 1 WAY - 3 PHASE DALHANDER MOTOR

 Technical Info (p. 224)

PANEL MOUNTING - TWO FIXING SCREWS

IP40 standard - IP65 available upon request

Contact Configuration - 9552

No. of contacts	LS	O	HS
1-2	X		
3-4			X
5-6			X
7-8	X		
9-10			X
11-12			X
13-14	X		
15-16			X

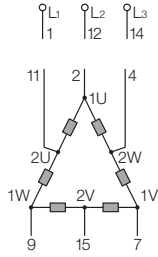
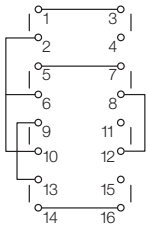

NZ52CQ1



SZ52BQ1



ZZ52BQ7



HZ52BQ7

Mounting and Dimensions see pg 226 to 229

No. of contacts	O	LS	HS
1-2		X	
3-4			X
5-6			X
7-8		X	
9-10			X
11-12			X
13-14		X	
15-16			X

Switch Series	General use rating - amps	Number of contacts	Positions	Designation	Part Number
PR12	12	8		PR12 9552 B4 E Q48PN50	NZ52BQ1
PR17	16	8		PR17 9552 B4 E Q48PN50	SZ52BQ1
PR21	20	8		PR21 9552 B4 E Q48PN50	TZ52BQ1
PR26	25	8		PR26 9552 B4 E Q72MN50	ZZ52BQ7
PR40	50	8		PR40 9552 B4 E Q72MN60	HZ52BQ7
PR63	63	8		PR63 9552 B4 E Q72MN60	IZ52BQ7

PR12	12	8		PR12 9552 C4 E Q48PN50	NZ52CQ1
PR17	16	8		PR17 9552 C4 E Q48PN50	SZ52CQ1
PR21	20	8		PR21 9552 C4 E Q48PN50	TZ52CQ1
PR26	25	8		PR26 9552 C4 E Q72MN50	ZZ52CQ7
PR40	50	8		PR40 9552 C4 E Q72MN60	HZ52CQ7
PR63	63	8		PR63 9552 C4 E Q72MN60	IZ52CQ7

CAM SWITCHES

▶ 2 SPEEDS, 1 WAY - 3 PHASE DALHANDER MOTOR

 Technical Info (p. 224)

IN ENCLOSURE

IP40 standard - IP65 available upon request

Contact Configuration - 9552

No. of contacts	LS	O	HS
1-2	X		
3-4			X
5-6			X
7-8	X		
9-10			X
11-12			X
13-14	X		
15-16			X

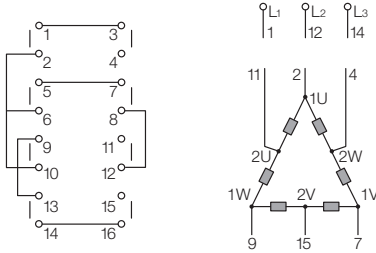

NZ52CXQ



TZ52BXQ





ZZ52BXQ



HZ52BDQ

Mounting and Dimensions see pg 226 to 229

No. of contacts	O	LS	HS
1-2		X	
3-4			X
5-6			X
7-8	X		
9-10			X
11-12			X
13-14	X		
15-16			X

Switch Series	General use rating - amps	Number of contacts	Positions	Designation	Part Number
PR12	12	8		PR12 9552 B4 BCQ3	NZ52BXQ
PR17	16	8		PR17 9552 B4 BCQ3	SZ52BXQ
PR21	20	8		PR21 9552 B4 BCQ3	TZ52BXQ
PR26	25	8		PR26 9552 B4 BCQ3	ZZ52BXQ
PR40	50	8		PR40 9552 B4 BCF Q72MN60	HZ52BDQ
PR63	63	8		PR63 9552 B4 BCF Q72MN60	IZ52BDQ
PR12	12	8		PR12 9552 C4 BCQ3	NZ52CXQ
PR17	16	8		PR17 9552 C4 BCQ3	SZ52CXQ
PR21	20	8		PR21 9552 C4 BCQ3	TZ52CXQ
PR26	25	8		PR26 9552 C4 BCQ3	ZZ52CXQ
PR40	50	8		PR40 9552 C4 BCF Q72MN60	HZ52CDQ
PR63	63	8		PR63 9552 C4 BCF Q72MN60	IZ52CDQ

CAM SWITCHES

▶ AMMETER SWITCHES

 Technical Info (p. 224)

3 CURRENT TRANSFORMERS WITH COMMON POINT

IP40 standard - IP65 available upon request

Contact Configuration - 8151

No. OF CONTACTS	0	L1	L2	L3
1 - 2	X	X		
3 - 4	X	X		
5 - 6		X	X	
7 - 8		X	X	
9 - 10	X		X	X
11 - 12	X		X	X

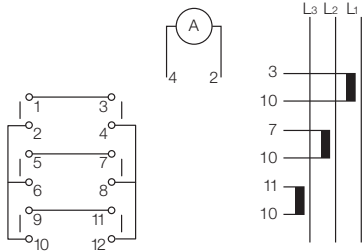



NY11AQ1



NY11AX80

Mounting and Dimensions see pg 226 to 229

Switch Series	General use rating - amps	Mounting	Number of contacts	Positions	Designation	Part Number
PR12	12	TWO FIXING SCREWS	6		PR12 8151 A4 E Q48PN50	NY11AQ1
PR12	12	Ø22MM SINGLE HOLE	6		PR12 8151 A4 E N48MD50	NY11AX80

WITHOUT CURRENT TRANSFORMER

IP40 standard - IP65 available upon request

Contact Configuration - 8164

No. of contacts	0	L1	L2	L3
1 - 2	X	X		
3 - 4	X	X		
5 - 6		X	X	
7 - 8		X	X	
9 - 10	X		X	X
11 - 12	X		X	X
13 - 14	X		X	X
15 - 16		X	X	
17 - 18		X	X	

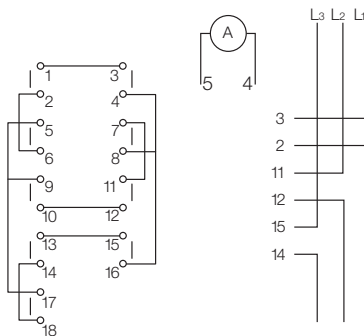



NY14AQ1



NY14AX80

Mounting and Dimensions see pg 226 to 229

Switch Series	General use rating - amps	Mounting	Number of contacts	Positions	Designation	Part Number
PR12	12	TWO FIXING SCREWS	9		PR12 8164 A4 E Q48PN50	NY14AQ1
PR12	12	Ø22MM SINGLE HOLE	9		PR12 8164 A4 E N48MD50	NY14AX80

CAM SWITCHES

▶ AMMETER SWITCHES

 Technical Info (p. 224)

WITHOUT COMMON POINT

IP40 standard - IP65 available upon request

Contact Configuration - 8157

No. of CONTACTS	0	L1	L2	L3
1 - 2		X	X	
3 - 4	X	X		
5 - 6	X	X		
7 - 8		X	X	
9 - 10	X	X	X	
11 - 12		X	X	
13 - 14			X	X
15 - 16	X		X	X
19 - 20			X	X

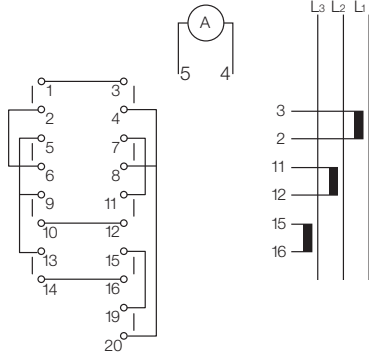



NY17AQ1



NY17AX80

Mounting and Dimensions see pg 226 to 229

Switch Series	General use rating - amps	Mounting	Number of contacts	Positions	Designation	Part Number
PR12	12	TWO FIXING SCREWS	9		PR12 8157 A4 E Q48PN50	NY17AQ1
PR12	12	Ø22MM SINGLE HOLE	9		PR12 8157 A4 E N48MD50	NY17AX80

CAM SWITCHES

VOLTMETER SWITCHES

 Technical Info (p. 224)

WITHOUT NEUTRAL

IP40 standard - IP65 available upon request

Contact Configuration - 8351

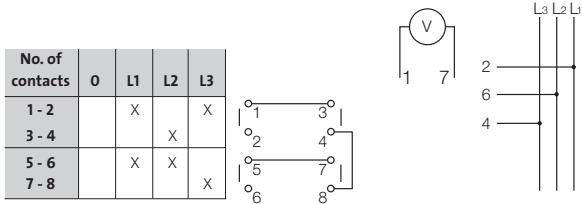

NY31AQ1



NY31AX80

Mounting and Dimensions see pg 226 to 229

Switch Series	General use rating - amps	Mounting	Number of contacts	Positions	Designation	Part Number
PR12	12	TWO FIXING SCREWS	4		PR12 8351 A4 E Q48PN50	NY31AQ1
PR12	12	Ø22MM SINGLE HOLE	4		PR12 8351 A4 E N48MD50	NY31AX80

WITH NEUTRAL

IP40 standard - IP65 available upon request

Contact Configuration - 8357

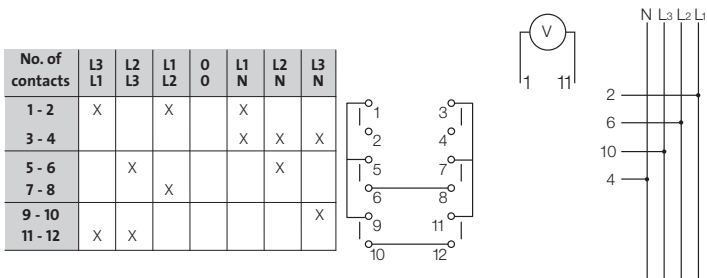

NY37AQ1



NY37AX80



NDF03

Mounting and Dimensions see pg 226 to 229

Switch Series	General use rating - amps	Mounting	Number of contacts	Positions	Designation	Part Number
PR12	12	TWO FIXING SCREWS	6		PR12 8357 C8 E Q48PN50	NY37AQ1
PR12	12	Ø22MM SINGLE HOLE	6		PR12 8357 C8 E N48MD50	NY37AX80
PR12	12	DIN-RAIL	6		PR12 8357 C8 E DF	NDF03

CAM SWITCHES

▶ BINARY CODE SWITCHES

 Technical Info (p. 224)

0 TO 11

IP40 standard - IP65 available upon request

Contact Configuration - 6501

No. of contacts	Positions											
	0	1	2	3	4	5	6	7	8	9	10	11
1 - 2		X		X		X		X		X		X
3 - 4			X	X			X	X			X	X
5 - 6					X			X				
7 - 8									X			X

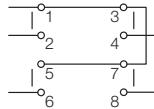

NR51UQ1

Mounting and Dimensions see pg 226 to 229

Switch Series	General use rating - amps	Mounting	Number of contacts	Positions	Designation	Part Number
PR12	12	Two FIXING SCREWS	4		PR12 6501 A1 E Q48PN50	NR51UQ1

1 TO 12

IP40 standard - IP65 available upon request

Contact Configuration - 6501

No. of contacts	Positions											
	1	2	3	4	5	6	7	8	9	10	11	12
1 - 2	X		X		X		X		X		X	
3 - 4		X	X			X	X			X	X	
5 - 6				X			X					
7 - 8								X				X

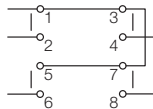

NR52UQ1

Mounting and Dimensions see pg 226 to 229

Switch Series	General use rating - amps	Mounting	Number of contacts	Positions	Designation	Part Number
PR12	12	Two FIXING SCREWS	4		PR12 6502 A1 E Q48PN50	NR52UQ1

CAM SWITCHES

► Technical Specifications

UL/CSA Characteristics	PR 12	PR 17	PR 21	PR 26	PR 40	PR 63	PR 125	PR 160
► UL/CSA								
1 PHASE 110/120 VAC	0.5 HP	1 HP	1.5 HP	2 HP	3 HP	5 HP	N/A	N/A
3 PHASE 110/120 VAC 220/240 VAC 440/480 VAC 550/600 VAC	1 HP	2 HP	3 HP	3 HP	7.5 HP	10 HP	N/A	N/A
	3 HP	5 HP	5 HP	7.5 HP	15 HP	20 HP	N/A	N/A
	5 HP	7.5 HP	10 HP	15 HP	30 HP	40 HP	N/A	N/A
	3 HP	10 HP	15 HP	20 HP	30 HP	40 HP	N/A	N/A
GENERAL USE (600 V) (MOTOR CONTROLLER)	12 A	16A	20 A	25 A	50 A	63 A	N/A	N/A
UL 508 RECOGNIZED	YES	YES	YES	YES	YES	YES	No	No
CSA CERTIFIED	YES	YES	YES	YES	YES	YES	No	No
IEC Characteristics								
► For thermal current AC-20 lth I_c(A) (IEC 60 947-3)	20	25	32	40	63	80	200	250
► Rated operating current for AC-21 A I_e(A) (IEC 60 947-3) Switching of resistive loads including moderate overloads	16	20	25	32	50	80	160	200
► Rated operating current for AC-15 A I_e(A) at 230V AC (IEC 60 947-3) Control of electromagnetic loads	6	8	10	12	-	-	-	-
► Performance in AC 23 (kW) (IEC 60 947-3) Switching of motors or other highly inductive loads								
- 3 x 230 V	4	5.5	7.5	11	15	18.5	-	-
- 3 x 400 V	7.5	11	11	11	22	25	-	-
- 3 x 500 V	5.5	11	11	11	25	25	-	-
- 3 x 690 V	4	10	10	11	18.5	22	-	-
► Performance in AC 3 (IEC 60 947-3) Control of squirrel-cage motors starting and switching off motors while running - In kW								
- 3 x 230 V	3	4	4	5.5	11	15	-	-
- 3 x 400 V	4	7.5	7.5	11	18.5	22	-	-
- 3 x 500 V	5.5	7.5	7.5	11	18.5	22	-	-
- 3 x 690 V	3	7.5	7.5	11	18.5	22	-	-

CAM SWITCHES

► Technical Specifications

IEC Characteristics	PR 12	PR 17	PR 21	PR 26	PR 40	PR 63	PR 125	PR 160
► Performance in AC 3 - cont.								
- In HP (for reference)								
- 3 x 230 V	4	5.5	5.5	7.5	15	20	-	-
- 3 x 400 V	5.5	10	10	15	25	30	-	-
- 3 x 500 V	7.5	10	10	15	25	30	-	-
- 3 x 690 V	4	10	10	15	25	30	-	-
► Rated insulation voltage U_i (V)								
- Max. rated voltage $U_e(v)$ IEC	690	690	690	690	690	690	690	690
- CSA (Canada)	600	600	600	600	600	600	600	600
- UL (USA)	600	600	600	600	600	600	600	600
► Rated short time withstand current I_{cw} (A) for 1 sec								
	250	400	420	800	1000	1000	2000	2400
► Maximum wire size (mm²)								
- rigid	4	6/4 ⁽¹⁾	6/4 ⁽¹⁾	6	16	16	ø 8 screw for eyelet	
- flexible	2.5	4	4	6	16	16	ø 8 screw for eyelet	
► Maximum wire size (AWG)								
- rigid	10	8/10 ⁽¹⁾	8/10 ⁽¹⁾	8	6	6		
- flexible	14	12	12	8	6	6		
(1): These values correspond to terminals with jumpers								
► Mechanical durability 1,250,000 operations, maximum rate 150 operations per hour								
► Operating temperature limits - 20°C to + 70°C - 4°F to + 158°F (beyond these limits consult us)								
► Rated operating current in DC-1 low inductive loads (< 1 ms)								
	PR 12	PR 17	PR 21	PR 26	PR 40	PR 63	PR 125	PR 160
Rated operating current I_e (A) 24 V DC	16	20	25	32	50	80	-	-
I_e (A): rated current for breaking 1 contact. For higher voltages you must use a reduction coefficient K in the following graph								

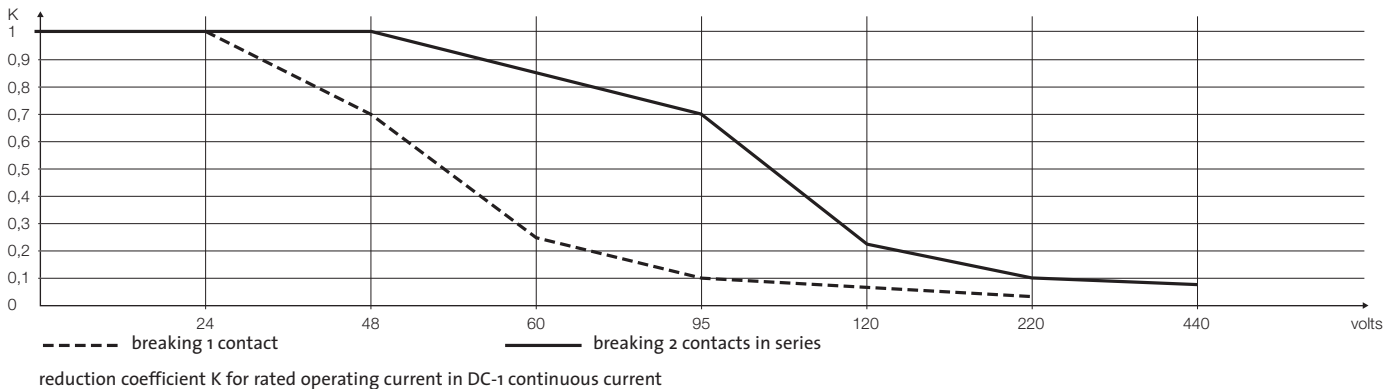

CAM SWITCHES

► Mounting

2 SCREWS - 30 OR 50 MM INTERVAL

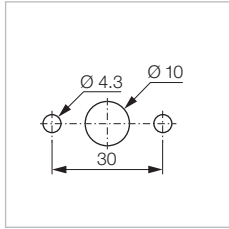

PR 12
PR 17
PR 21
PR 26

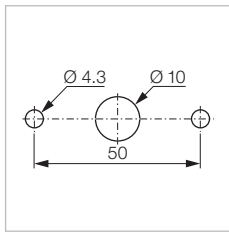

PR 40
PR 63

SINGLE HOLE MOUNTING Ø 22

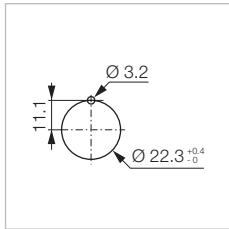

For PR12 only

- 48 legend plate with handle
- HANDLE
- LEVER
- KEY



CAM SWITCHES

► Dimensions

2 SCREW FRONT MOUNTING (E)

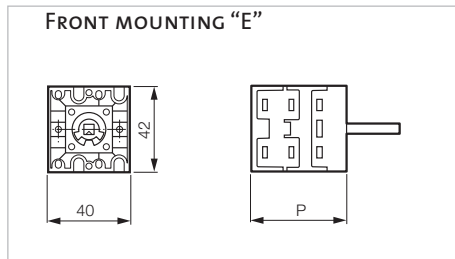

PR 12	No. of contacts	P*
	1-2	36
	3-4	46
	5-6	56
	7-8	66
	9-10	76
	11-12	86

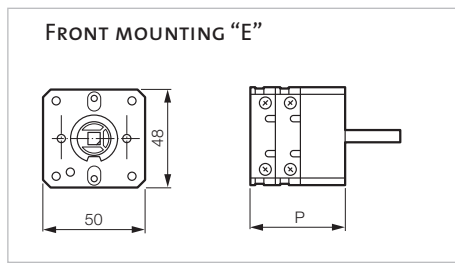

PR 17/21	No. of contacts	P*
	1-2	33
	3-4	45
	5-6	57
	7-8	69
	9-10	81
	11-12	93

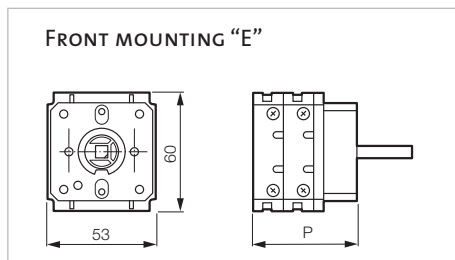

PR 26	No. of contacts	P*
	1-2	36
	3-4	51
	5-6	66
	7-8	81
	9-10	96
	11-12	111

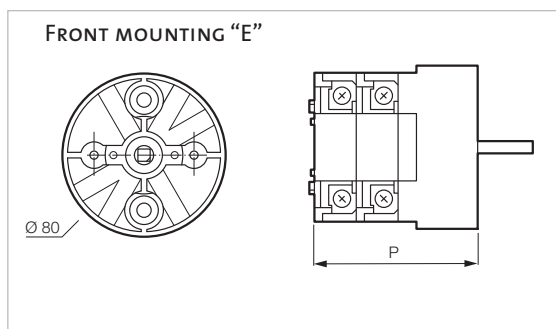

PR 40/63	No. of contacts	P*
	1-2	60
	3-4	80
	5-6	100
	7-8	120
	9-10	140
	11-12	160

CAM SWITCHES

► Dimensions

SINGLE HOLE MOUNTING Ø 22

FRONT MOUNTING "E N48MD50"

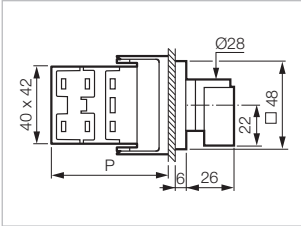

**WITH HANDLE AND
LEGEND PLATE**

No. of contacts	P*
1-2	51
3-4	61
5-6	71
7-8	81
9-10	91
11-12	101

FRONT MOUNTING "E C21RA03"

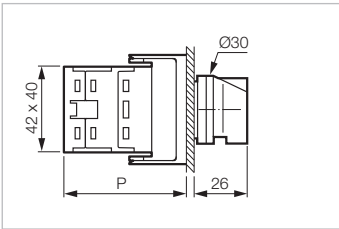

**WITH HANDLE
OR LEVER**

No. of contacts	P*
1-2	51
3-4	61
5-6	71
7-8	81
9-10	91
11-12	101

FRONT MOUNTING "E C21RC00"

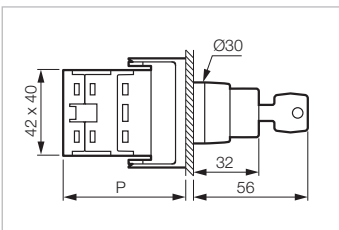

WITH KEY

No. of contacts	P*
1-2	51
3-4	61
5-6	71
7-8	81
9-10	91
11-12	101

CAM SWITCHES

► Dimensions

ENCLOSURES

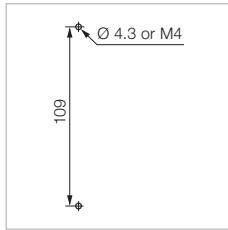
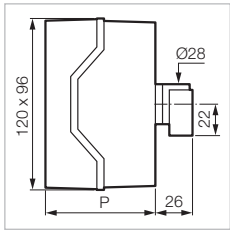

PR 12	No. of contacts	P*
	1-6	77
	7-10	101

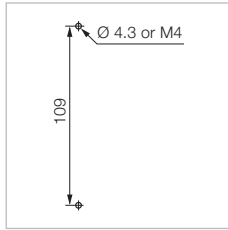
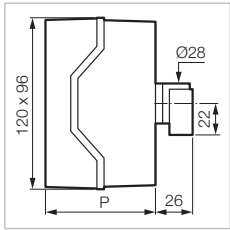

PR 17/21	No. of contacts	P*
	1-6	77
	7-10	101

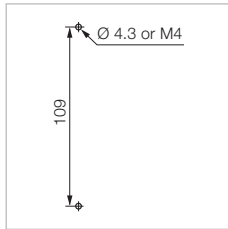
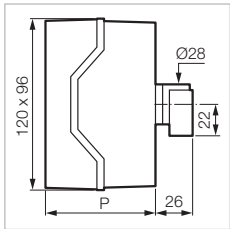

PR 26	No. of contacts	P*
	1-4	77
	5-8	101

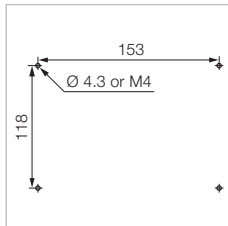
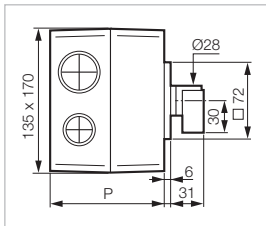

PR 40/63	No. of contacts	P*
	1-4	107
	5-8	145