

## DIN W72×H36mm, W96×H48mm, Digital Multi Panel Meter

### ■ Features

- Various input/output (default: indicator)
  - Input: DC voltage, DC current, AC voltage, AC current
  - Output: RS485 communication output, Low speed serial output, transmission (DC4-20mA) output, BCD dynamic output, NPN/PNP open collector output, relay output
- Maximum allowed input : 500VDC, 500VAC, DC5A, AC5A
- Display range: -1999 to 9999
- High/low-limit display scale function
- AC frequency measurement (range: 0.1 to 9999Hz)
- Various functions: Monitoring peak display value function, display cycle delay function, zero adjustment function, high display correction function, transmission (DC4-20mA) output scale function etc.
- Power supply: 12-24VDC, 100-240VAC 50/60Hz



**⚠ Please read "Safety Considerations" in operation manual before using.**



### ■ Ordering Information

**MT 4 W - DV - 4 N**

|      |       |      |                 |              |        |   |   |
|------|-------|------|-----------------|--------------|--------|---|---|
| Item | Digit | Size | Measuring input | Power supply | Output | <b>MT4Y</b><br>100-240VAC<br>12-24VDC,<br>100-240VAC<br><b>MT4W</b><br>100-240VAC | <b>N</b> Indicator (without output function)<br><b>0</b> Relay output<br><b>1</b> NPN open collector output<br><b>2</b> PNP open collector output<br><b>3</b> <sup>※1</sup> Relay (low out)+transmission (DC4-20mA) output<br><b>4</b> <sup>※1</sup> Relay (low out)+RS485 communication output<br><b>5</b> BCD dynamic output<br><b>6</b> Low speed serial output  |
|      |       |      |                 |              |        |   | <b>N</b> Indication type (no output function)<br><b>0</b> Relay+transmission (DC4-20mA) output<br><b>1</b> Relay output<br><b>2</b> NPN open collector+BCD dynamic output<br><b>3</b> PNP open collector+BCD dynamic output<br><b>4</b> NPN open collector+transmission (DC4-20mA) output<br><b>5</b> PNP open collector+transmission (DC4-20mA) output<br><b>6</b> NPN open collector+low speed serial output<br><b>7</b> PNP open collector+low speed serial output<br><b>8</b> NPN open collector+RS485 communication output<br><b>9</b> PNP open collector+RS485 communication output |
|      |       |      |                 |              |        |   | <b>1</b> <sup>※2</sup> 12-24VDC<br><b>4</b> 100-240VAC 50/60Hz  |
|      |       |      |                 |              |        |   | <b>DV</b> DC voltage<br><b>DA</b> DC current<br><b>AV</b> AC voltage<br><b>AA</b> AC current  |
|      |       |      |                 |              |        |   | <b>Y</b> DIN W72×H36mm<br><b>W</b> DIN W96×H48mm  |
|      |       |      |                 |              |        |   | <b>4</b> 9999 (4-digit)   |
|      |       |      |                 |              |        |   | <b>MT</b> Multi meter   |

※1: Only L5t (preset output mode) setting is available in MT4Y-□-43 (relay (low out)+transmission (DC4-20mA) output) and MT4Y-□-43 (relay (low out)+transmission (DC4-20mA) output) models.

※2: Only for MT4W.

※To measure the current over DC5A, please select DV type because the shunt should be used.

※In case of selecting frequency display, no output will be provided even if it is output support models. (main output, sub output and RS485 communication output)

- (A) Photoelectric Sensors
- (B) Fiber Optic Sensors
- (C) Door/Area Sensors
- (D) Proximity Sensors
- (E) Pressure Sensors
- (F) Rotary Encoders
- (G) Connectors/ Connector Cables/ Sensor Distribution Boxes/Sockets
- (H) Temperature Controllers
- (I) SSRs / Power Controllers
- (J) Counters
- (K) Timers
- (L) Panel Meters
- (M) Tacho / Speed / Pulse Meters
- (N) Display Units
- (O) Sensor Controllers
- (P) Switching Mode Power Supplies
- (Q) Stepper Motors & Drivers & Controllers
- (R) Graphic/ Logic Panels
- (S) Field Network Devices
- (T) Software

# MT4Y/MT4W Series

## Specifications

| Series                           | MT4Y-DV-4□<br>MT4Y-DA-4□   | MT4Y-AV-4□<br>MT4Y-AA-4□  | MT4W-DV-4□<br>MT4W-DA-4□ | MT4W-AV-4□<br>MT4W-AA-4□       | MT4W-DV-1□<br>MT4W-DA-1□ | MT4W-AV-1□<br>MT4W-AA-1□       |
|----------------------------------|--|---|--------------------------|--------------------------------|--------------------------|--------------------------------|
| Measurement input                | DC voltage, current  | AC voltage, current, Frequency  | DC voltage, current      | AC voltage, current, Frequency | DC voltage, current      | AC voltage, current, Frequency |
| Power supply                     | 100-240VAC~ 50/60Hz  |   |                          |                                | 12-24VDC=                |                                |
| Allowable voltage range          | 90 to 110%   |   |                          |                                | 90 to 110%               |                                |
| Power consumption                | 5VA  |   |                          |                                | 5W                       |                                |
| Display method                   | 7-segment LED display (red) (character height: 14.2mm)   |   |                          |                                |                          |                                |
| Display accuracy                 | • 23°C±5°C - DC Type: F.S. ±0.1% rdg±2-digit / AC Type: F.S. ±0.3% rdg±3-digit (frequency: F.S.±0.1% rdg±2-digit)<br>DC/AC Type: F.S. +0.3% rdg ±3-digit max. only for 5A terminal<br>• -10°C to 50°C - DC/AC Type: F.S.±0.5% rdg±3-digit  |   |                          |                                |                          |                                |
| Max. allowable input             | 110% F.S. for each measured input range  |   |                          |                                |                          |                                |
| A/D conversion method            | Practical oversampling using successive approximation ADC  |   |                          |                                |                          |                                |
| Sampling cycle                   | DC type: 50ms, AC type: 16.6ms   |   |                          |                                |                          |                                |
| Max. display range               | -1999 to 9999 (4-digit)  |   |                          |                                |                          |                                |
| Preset output                    | • Relay output - Contact capacity: 250VAC~ 3A, 30VDC= 3A / Contact composition: N.O (1a)<br>• NPN/PNP Open collector output - Max. 12-24VDC= ±2V 50mA (resistive load)   |   |                          |                                |                          |                                |
| Sub output (transmission output) | • RS485 communication output - Baud rate: 1,200/2,400/4,800/9,600, Communication method : 2-wire half duplex, Synchronous method: Asynchronous method, Protocol: Modbus type<br>• Serial/BCD dynamic output - NPN Open collector output: 12-24VDC Max. 50mA (resistive load)<br>• DC4-20mA output - Resolution: 12,000 division (load resistance max. 600Ω), Response time: max. 450ms |   |                          |                                |                          |                                |
| AC measuring function*1          | Selectable RMS or AVG  |   |                          |                                |                          |                                |
| Frequency measurement function*1 | Measurement range: 0.100 to 9999Hz (variable by decimal point position)  |   |                          |                                |                          |                                |
| Hold function*2                  | Includes (external hold function)  |   |                          |                                |                          |                                |
| Insulation resistance            | Over 100MΩ (at 500VDC megger, between external terminal and case)  |   |                          |                                |                          |                                |
| Dielectric strength              | 2000VAC 50/60Hz for 1 min (between external terminal and case)   |   |                          |                                |                          |                                |
| Noise immunity                   | ±2kV the square wave noise (pulse width: 1μs) by the noise simulator   |   |                          |                                |                          |                                |
| Vibration                        | Mechanical   | 0.75mm amplitude at frequency of 10 to 55Hz (for 1 min) in each X, Y, Z direction for 2 hours |                          |                                |                          |                                |
|                                  | Malfunction  | 0.5mm amplitude at frequency of 10 to 55Hz (for 1 min) in each X, Y, Z direction for 10 min   |                          |                                |                          |                                |
| Shock                            | Mechanical   | 100m/s <sup>2</sup> (approx. 10G) in each X, Y, Z direction for 3 times                       |                          |                                |                          |                                |
|                                  | Malfunction  | 300m/s <sup>2</sup> (approx. 30G) in each X, Y, Z direction for 3 times                       |                          |                                |                          |                                |
| Relay life cycle                 | Malfunction  | Min. 20,000,000 operations  |                          |                                |                          |                                |
|                                  | Mechanical   | Min. 100,000 operations (250VAC 3A load current)  |                          |                                |                          |                                |
| Environment                      | Ambient temperature  | -10 to 50°C, storage: -20 to 60°C   |                          |                                |                          |                                |
|                                  | Ambient humidity   | 35 to 85%RH, storage: 35 to 85%RH   |                          |                                |                          |                                |
| Insulation type                  | Double insulation or reinforced insulation (mark: □, dielectric strength between the measuring input part and the power part: 1kV)   |   |                          |                                |                          |                                |
| Approval                         | CE  us  |   |                          |                                | CE                       |                                |
| Weight*3                         | Approx. 213.5g (approx. 134g)  |   |                          | Approx. 326g (approx. 211g)    |                          |                                |

\*1: AC measuring function, and frequency measuring function are only for AC measuring input type.

\*2: MT4Y□-4N model has no hold function.

\*3: The weight includes packaging. The weight in parenthesis is for unit only.

※Environment resistance is rated at no freezing or condensation.

## Unit Description

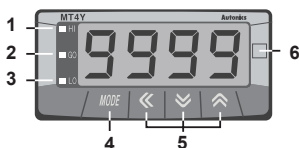

### MT4Y Series

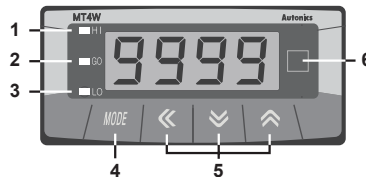

1. HI: High output indication of preset
2. GO: GO output indication of preset
3. LO: Low output indication of preset

### MT4W Series



4.  key: mode key
5.  key: moves digit, enters parameter mode,  key: changes sv
6. unit label part

※ There is no 1, 2, 3 on a display panel of MT4Y□-4N, 45, 46 and MT4W□-4N.

※ In MT4Y□-□3, □4, OUT is used for Go output display and there is no 1, 3 in display panel.

## ■ Connections

### ◎ Measuring input connection of MT4Y Series

#### ● MT4Y-DV-4 □

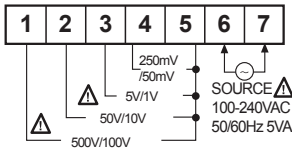

#### ● MT4Y-DA-4 □

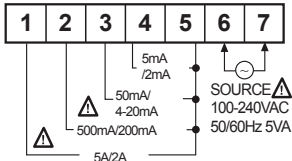

#### ● MT4Y-AV-4 □

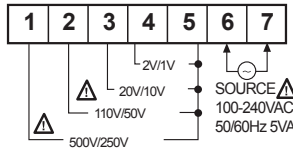

#### ● MT4Y-AA-4 □

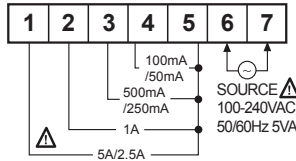

### ◎ Output terminal connection of MT4Y Series

#### ● MT4Y-□-4N (indicator)

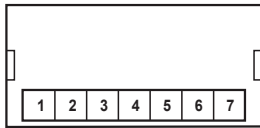

#### ● MT4Y-□-40 (triple relay output)

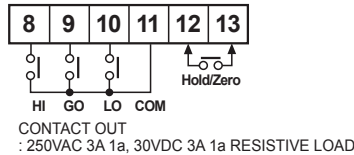

#### ● MT4Y-□-41

(triple NPN open collector output)

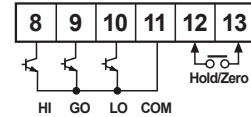

#### ● MT4Y-□-42

(triple PNP open collector output)

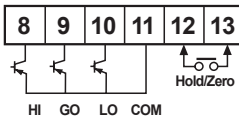

#### ● MT4Y-□-43

(relay+transmission (DC4-20mA) output)

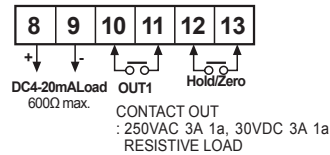

#### ● MT4Y-□-44

(relay+RS485 communication output)

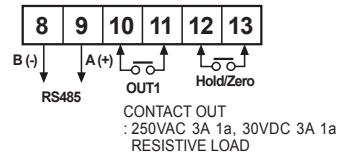

#### ● MT4Y-□-45 (BCD dynamic output)

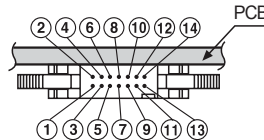
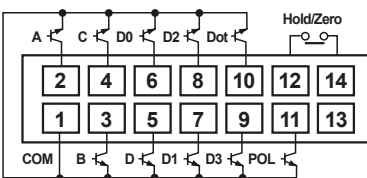

※Hirose connector pin header model of the unit: HIF3BA-14PA-2.54DS

※Contact Hirose Electric to purchase socket and wires of Hirose connector.

[Socket: HIF3BA-14D-2.54R]

#### ● MT4Y-□-46 (low speed serial output)

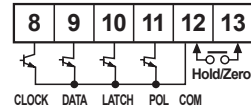

※POL: When a display value is "-", the signal of "-" will be outputted.

### ◎ Measuring input connection of MT4W Series

#### ● MT4W-DV-□ □

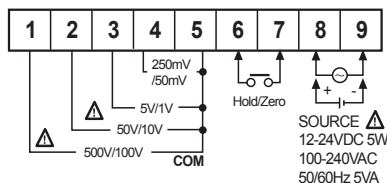

#### ● MT4W-DA-□ □

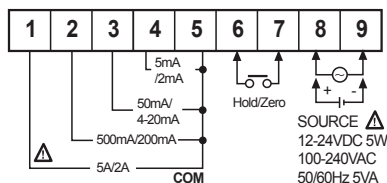

#### ● MT4W-AV-□ □

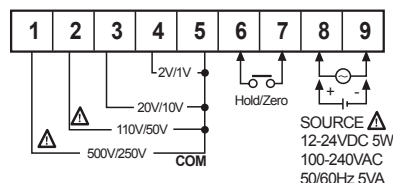

#### ● MT4W-AA-□ □

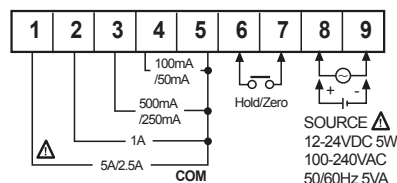

|     |   |
|-----|---|
| (A) | Photoelectric Sensors   |
| (B) | Fiber Optic Sensors   |
| (C) | Door/Area Sensors   |
| (D) | Proximity Sensors   |
| (E) | Pressure Sensors  |
| (F) | Rotary Encoders   |
| (G) | Connectors/ Connector Cables/ Sensor Distribution Boxes/Sockets |
| (H) | Temperature Controllers   |
| (I) | SSRs / Power Controllers  |
| (J) | Counters  |
| (K) | Timers  |
| (L) | Panel Meters  |
| (M) | Tacho / Speed / Pulse Meters                                    |
| (N) | Display Units   |
| (O) | Sensor Controllers  |
| (P) | Switching Mode Power Supplies                                   |
| (Q) | Stepper Motors & Drivers & Controllers                          |
| (R) | Graphic/ Logic Panels   |
| (S) | Field Network Devices   |
| (T) | Software  |

# MT4Y/MT4W Series

## ◎ Output terminal connection of MT4W Series

- **MT4W-□-□0** (triple relay+transmission (DC4-20mA) output)
- **MT4W-□-□1** (triple relay output)

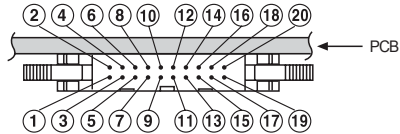
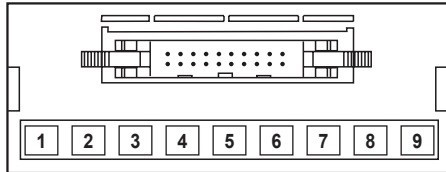
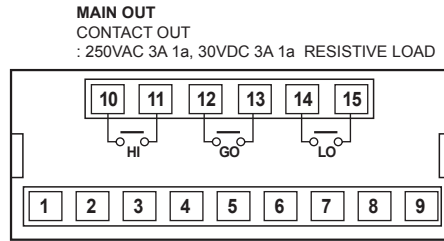
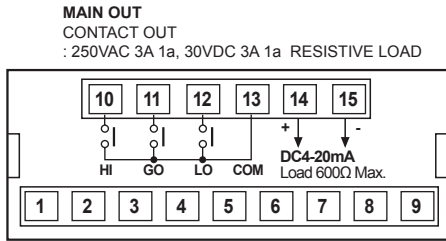

※Hirose connector pin header model of the unit: HIF3BA-20PA-2.54DS  
※Contact Hirose Electric to purchase socket and wires of Hirose connector.  
[Socket: HIF3BA-20D-2.54R]

- **MT4W-□-□2 / MT4W-□-□3** (triple NPN/PNP open collector+BCD dynamic output)

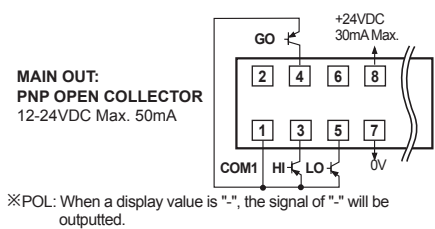
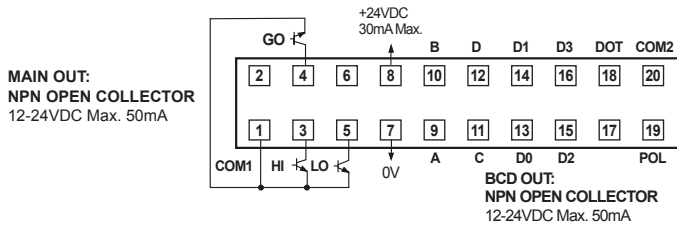

- **MT4W-□-□4 / MT4W-□-□5** (triple NPN/PNP open collector+transmission (DC4-20mA) output)

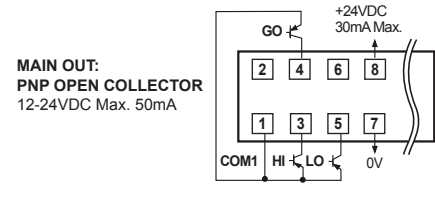
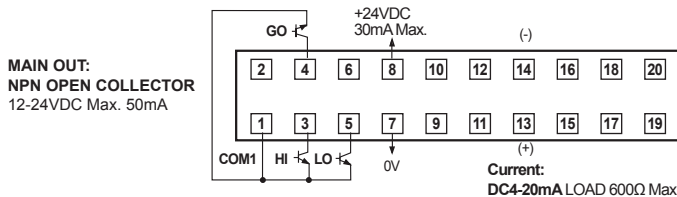

- **MT4W-□-□6 / MT4W-□-□7** (triple NPN/PNP open collector+low speed serial output)

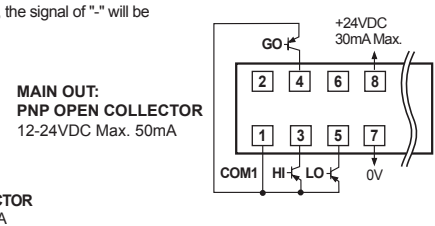
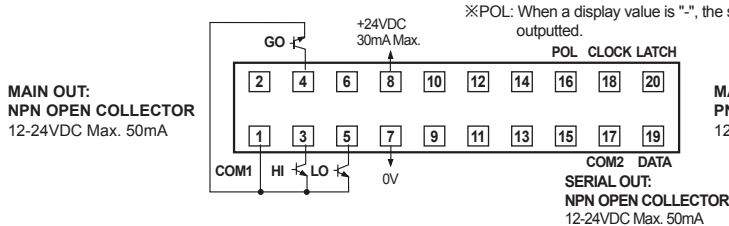

- **MT4W-□-□8 / MT4W-□-□9** (triple NPN/PNP open collector+RS485 communication output)

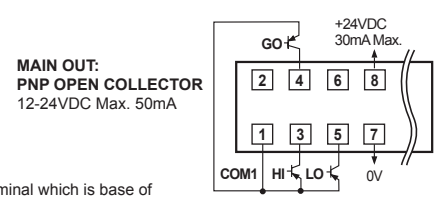
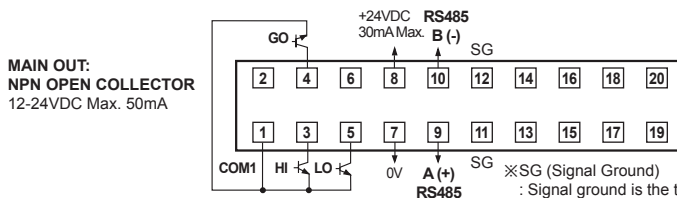

## ■ Dimensions

(unit: mm)

### ● MT4Y-□-4N, 45, 46

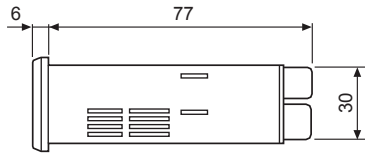
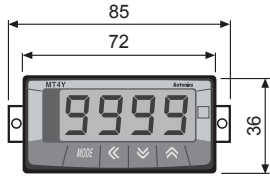

<MT4Y-□-4N, 40 to 44, 46>

### ● Panel cut-out

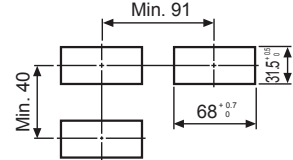

### ● MT4Y-□-43, 44

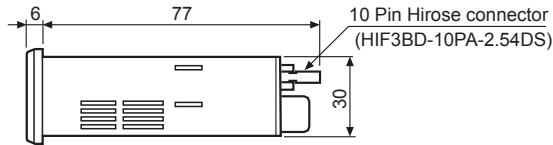

<MT4Y-□-45>

### ● MT4Y-□-40, 41, 42



### ● MT4W-□-□N (indicator)

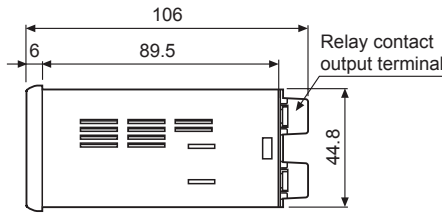
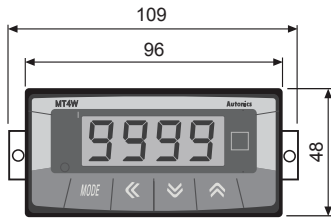

※ There is no Relay output terminal block in indication type.

< MT4W-□-□N, MT4W-□-□0, □1 >

### ● Panel cut-out

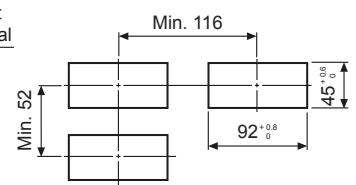

### ● MT4W-□-□0 to □9

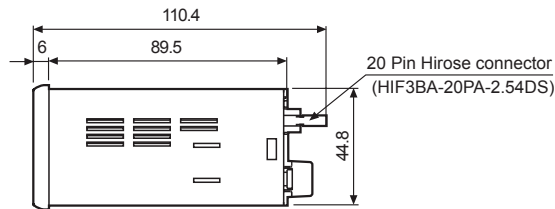

< MT4W-□-□2 to □9 >

## ■ Parameter Setting

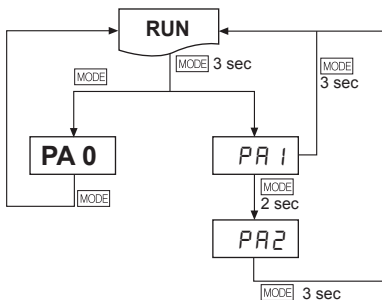

- ※ Press [MODE] key in **RUN** mode and it enters **PA 0** group.
- ※ Press [MODE] key for over 3 sec in **RUN** mode, it displays [PA 1].
- ※ Press [MODE] key for over 5 sec in **RUN** mode, it displays [PA 2] after [PA 1].  
When pressing [MODE] key continually, it stops displaying at [PA 2].
- ※ It is advanced to current display parameter releasing [MODE] key at [PA 1] or [PA 2].
- ※ Press [MODE] key for over 3 sec in any parameter groups, it returns to **RUN** mode.
- ※ If any key is not entered for 60 sec in each parameter, it returns to **RUN** mode.
- ※ After returning to **RUN** mode, press [MODE] key within 2 sec, it returns to previous parameter. (Refer to the below descriptions of each parameter group.)
- ※ **PA 0** group cannot be entered when preset output mode of [PA 2] group is  $\square FF$ .

|     |   |
|-----|---|
| (A) | Photoelectric Sensors   |
| (B) | Fiber Optic Sensors   |
| (C) | Door/Area Sensors   |
| (D) | Proximity Sensors   |
| (E) | Pressure Sensors  |
| (F) | Rotary Encoders   |
| (G) | Connectors/ Connector Cables/ Sensor Distribution Boxes/Sockets |
| (H) | Temperature Controllers   |
| (I) | SSRs / Power Controllers  |
| (J) | Counters  |
| (K) | Timers  |
| (L) | Panel Meters  |
| (M) | Tacho / Speed / Pulse Meters                                    |
| (N) | Display Units   |
| (O) | Sensor Controllers  |
| (P) | Switching Mode Power Supplies                                   |
| (Q) | Stepper Motors & Drivers & Controllers                          |
| (R) | Graphic/ Logic Panels   |
| (S) | Field Network Devices   |
| (T) | Software  |

# MT4Y/MT4W Series

## Parameter 1 Group

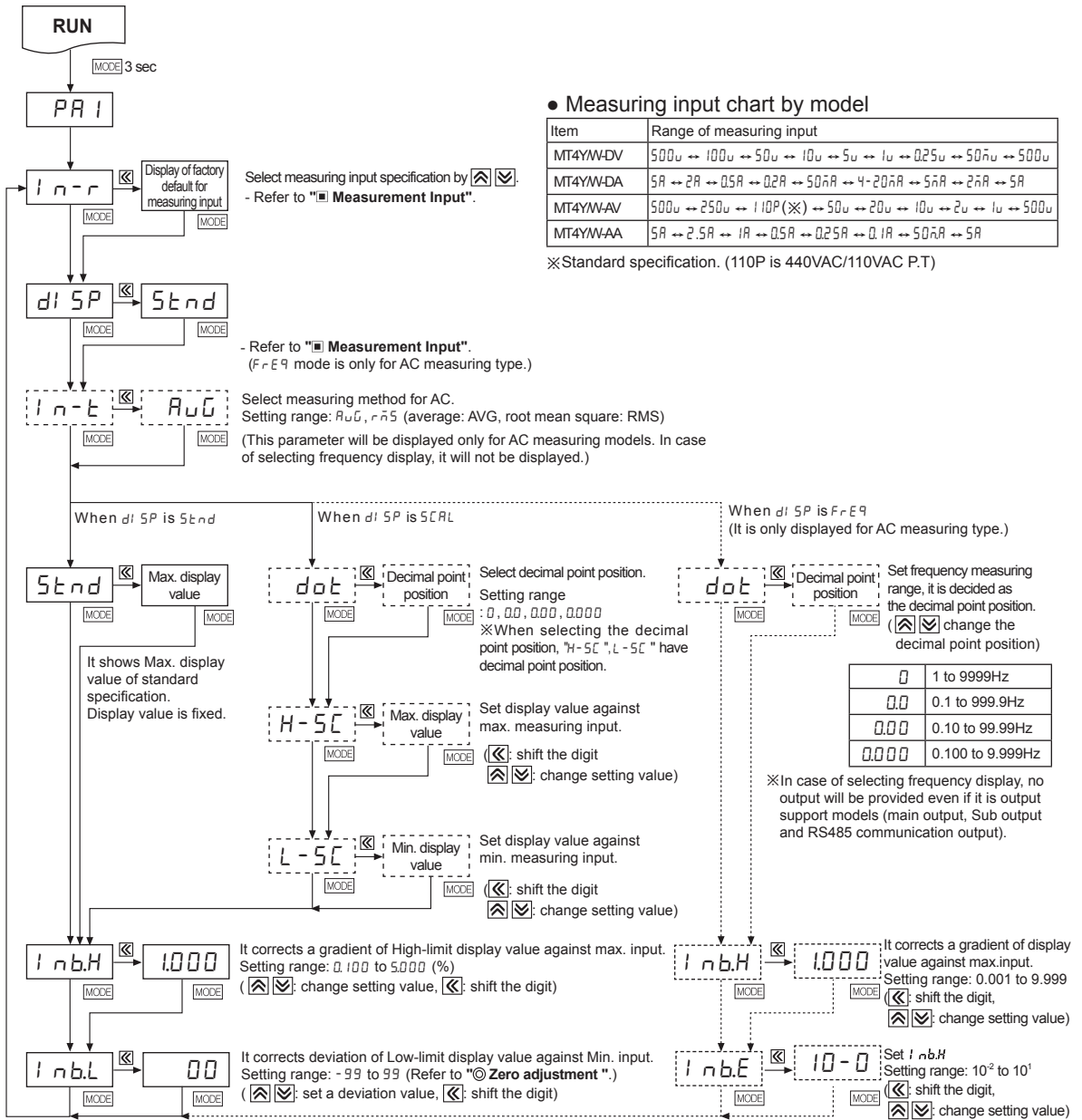

※After setting each mode, press **MODE** key for 2 sec to return to **RUN**.  
 ※If any key is untouched for 60 sec after advance to parameter, it will return to **RUN**.

## Factory defaults

| Parameter | MT4Y/W-DV | MT4Y/W-DA | MT4Y/W-AV | MT4Y/W-AA | Parameter | MT4Y/W-DV | MT4Y/W-DA | MT4Y/W-AV | MT4Y/W-AA |
|-----------|-----------|-----------|-----------|-----------|-----------|-----------|-----------|-----------|-----------|
| In-r      | 500 $\mu$ | 5A        | 500 $\mu$ | 5A        | In-bH     | 1.000     | 1.000     | 1.000     | 1.000     |
| di SP     | Stnd      | Stnd      | Stnd      | Stnd      | In-bL     | 00        | 00        | 00        | 00        |
| In-t      | —         | —         | AVG       | AVG       | dot       | 0.0       | 0.000     | 0.0       | 0.000     |
| Stnd      | 5000      | 5000      | 5000      | 5000      | In-bE     | —         | —         | 10-0      | 10-0      |

## Parameter 2 Group

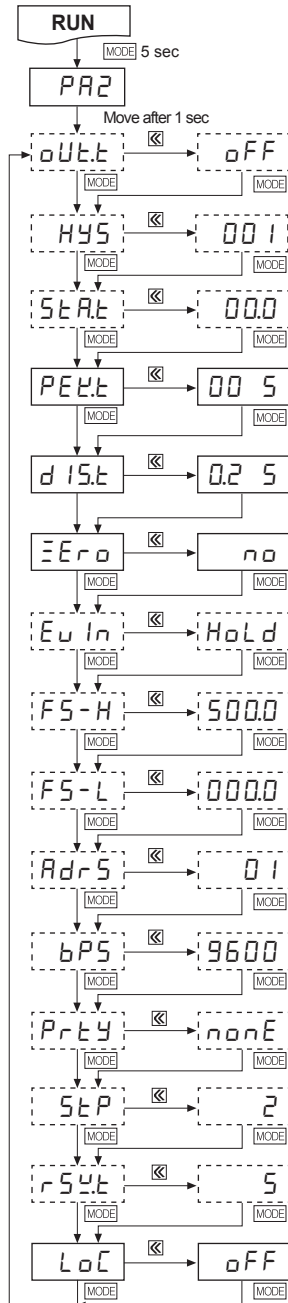

Select preset output mode. (only for available models)

Setting range: oFF, L5t, H5t, LH5t, HH5t, LL5t, Ld5t

※Only L5t setting is available in MT4Y□-43 and MT4Y□-44 models.

Set preset hysteresis. The range is within 10% of max. display range (unit: digit).

※ oUbt mode is oFF, it is not displayed.

Set startup compensation time.

(◀): shift the digit, (▲/▼): change setting value

Setting range: 0.0 to 99.9 sec

When initially supplying power, delays monitoring of high-limit/low-limit value of display value for the set time.

(◀): shift the digit, (▲/▼): change setting value

Setting range: 00 to 30 sec

※If it is set to 00 sec [00 5], parameters of high-peak monitoring value [HPeL]/low-limit monitoring value [LPEL] in the parameter 0 group will be not displayed.

Set display cycle and also variable sets by 0.1 sec. (◀): shift the digit, (▲/▼): change setting value

Setting range: 0.1 to 5.0 sec

Select zero function with operation at front. (set with (▲/▼) key)

When (◀) + (▲) Key are pressed for 3 sec to set SE5, it will be zero function and the deviation value is saved automatically at InbL mode.

Select input with 6, 7 (MT4W)[12, 13 (MT4Y)] terminal or zero function for external signal.

(set with (▲/▼) Key)

HoLd: Holding display value, EErO: Zero function using Hold/Zero terminal

Set the high limit value, output point of current output 20mA.

(◀): shift the digit, (▲/▼): change setting value

(When changing measuring input and prescale mode, it is changed automatically as maximum value of input range.)

Set the low limit value, output point of current output 4mA.

(◀): shift the digit, (▲/▼): change setting value

(When changing measuring input and prescale mode, it is changed automatically as minimum value of input range.)

Set the address of RS485 communication output.

(◀): shift the digit, (▲/▼): change setting value

Setting range: 01 to 99

Select Baud rate of RS485 communication output.

Setting range: 9600, 4800, 2400, 1200

Set parity bit of RS485 communication.

Setting range: nonE, EuEn, odd

Set stop bit of RS485 communication.

Setting range: 1, 2

Set response wait time of RS485 communication.

Setting range: 5 to 99

Set key lock function and select from 4 types.

Setting range: oFF, LoC1, LoC2, LoC3

|      |                           |
|------|---------------------------|
| oFF  | Disable to lock keys      |
| LoC1 | Lock Parameter 1          |
| LoC2 | Lock Parameter 1, 2       |
| LoC3 | Lock Parameter 0, 1 and 2 |

※The dotted mode is only displayed for output type.

※After setting each mode, press [MODE] key for 2 sec to return to RUN mode.

※If any key is untouched for 60 sec after advance to parameter, it will return to RUN mode.

## Factory defaults

| Parameter | MT4Y/W-DV | MT4Y/W-DA | MT4Y/W-AV | MT4Y/W-AA | Parameter | MT4Y/W-DV | MT4Y/W-DA | MT4Y/W-AV | MT4Y/W-AA |
|-----------|-----------|-----------|-----------|-----------|-----------|-----------|-----------|-----------|-----------|
| oUbt      | oFF       | oFF       | oFF       | oFF       | EuIn      | HoLd      | HoLd      | HoLd      | HoLd      |
| HYS       | 001       | 001       | 001       | 001       | FS-H      | 5000      | 5000      | 5000      | 5000      |
| StArE     | 000       | 000       | 000       | 000       | FS-L      | 0000      | 0000      | 0000      | 0000      |
| PEEL      | 005       | 005       | 005       | 005       | AdRS      | 01        | 01        | 01        | 01        |
| dISt      | 025       | 025       | 025       | 025       | bPS       | 9600      | 9600      | 9600      | 9600      |
| EErO      | no        | no        | no        | no        | PrtY      | nonE      | nonE      | nonE      | nonE      |
|           |           |           |           |           | StP       | 2         | 2         | 2         | 2         |
|           |           |           |           |           | rSyt      | 5         | 5         | 5         | 5         |
|           |           |           |           |           | LoC       | oFF       | oFF       | oFF       | oFF       |

(A) Photoelectric Sensors

(B) Fiber Optic Sensors

(C) Door/Area Sensors

(D) Proximity Sensors

(E) Pressure Sensors

(F) Rotary Encoders

(G) Connectors/ Connector Cables/ Sensor Distribution Boxes/Sockets

(H) Temperature Controllers

(I) SSRs / Power Controllers

(J) Counters

(K) Timers

(L) Panel Meters

(M) Tacho / Speed / Pulse Meters

(N) Display Units

(O) Sensor Controllers

(P) Switching Mode Power Supplies

(Q) Stepper Motors & Drivers & Controllers

(R) Graphic/ Logic Panels

(S) Field Network Devices

(T) Software

# MT4Y/MT4W Series

## Parameter 0 Group

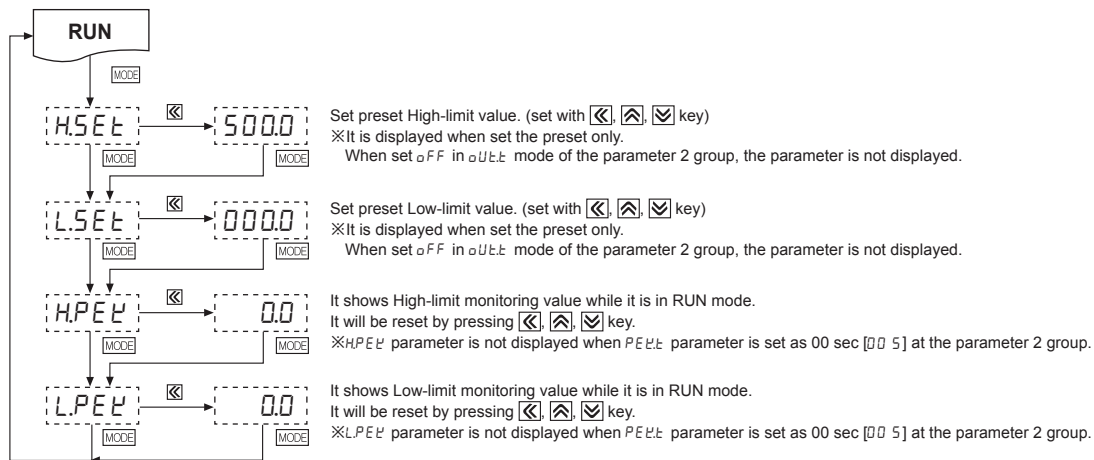

※If any key is untouched for 60 sec after advance to parameter, it will return to **RUN** mode.

## Factory defaults

| Parameter | MT4Y/W-DV | MT4Y/W-DA | MT4Y/W-AV | MT4Y/W-AA | Parameter | MT4Y/W-DV | MT4Y/W-DA | MT4Y/W-AV | MT4Y/W-AA |
|-----------|-----------|-----------|-----------|-----------|-----------|-----------|-----------|-----------|-----------|
| HSEt      | 5000      | 5000      | 5000      | 5000      | HPEt      | 0.0       | 0.000     | 0.0       | 0.0000    |
| LSEt      | 0000      | 0000      | 0000      | 0000      | LPEt      | 0.0       | 0.000     | 0.0       | 0.0000    |

## Measurement Input

| Type            | Measuring input and range | Input impedance        | Display range [5tnd]   | Prescale display range [5CL]   |      |               |   |               |     |                 |      |                 |       |                 |
|-----------------|---------------------------|------------------------|------------------------|--|------|---------------|---|---------------|-----|-----------------|------|-----------------|-------|-----------------|
| DC voltage      | 0-500V [500u]             | 4.33MΩ                 | 0.0 to 500.0 (fixed)   | <table border="1"> <tr> <td>dolt</td> <td>Display range</td> </tr> <tr> <td>0</td> <td>-1999 to 9999</td> </tr> <tr> <td>0.0</td> <td>-199.9 to 999.9</td> </tr> <tr> <td>0.00</td> <td>-19.99 to 99.99</td> </tr> <tr> <td>0.000</td> <td>-1.999 to 9.999</td> </tr> </table> <p>(Display range is variable according to decimal point position.)</p> <p>※Please wire the proper terminal to its max. input within 30 to 100% of the input terminal. When it is higher than input, it may cause terminal breakdown and HHHH appears. The accuracy is decreased when it is connected to the terminal under 30%.</p> <p>※In case of 0 to 110V [110P] of AC voltage range and using P.T (potential transformer) for 440V/110VAC, if 110V is input, and the unit displays 440V automatically by preset scale value for P.T user's convenient.</p> | dolt | Display range | 0 | -1999 to 9999 | 0.0 | -199.9 to 999.9 | 0.00 | -19.99 to 99.99 | 0.000 | -1.999 to 9.999 |
|                 | dolt                      | Display range          |                        |  |      |               |   |               |     |                 |      |                 |       |                 |
|                 | 0                         | -1999 to 9999          |                        |  |      |               |   |               |     |                 |      |                 |       |                 |
|                 | 0.0                       | -199.9 to 999.9        |                        |  |      |               |   |               |     |                 |      |                 |       |                 |
|                 | 0.00                      | -19.99 to 99.99        |                        |  |      |               |   |               |     |                 |      |                 |       |                 |
|                 | 0.000                     | -1.999 to 9.999        |                        |  |      |               |   |               |     |                 |      |                 |       |                 |
|                 | 0-100V [100u]             | 4.33MΩ                 | 0.0 to 100.0 (fixed)   |  |      |               |   |               |     |                 |      |                 |       |                 |
|                 | 0-50V [50u]               | 433.15kΩ               | 0.00 to 50.00 (fixed)  |  |      |               |   |               |     |                 |      |                 |       |                 |
| 0-10V [10u]     | 433.15kΩ                  | 0.00 to 10.00 (fixed)  |                        |  |      |               |   |               |     |                 |      |                 |       |                 |
| 0-5V [5u]       | 43.15kΩ                   | 0.000 to 5.000 (fixed) |                        |  |      |               |   |               |     |                 |      |                 |       |                 |
| 0-1V [1u]       | 43.15kΩ                   | 0.000 to 1.000 (fixed) |                        |  |      |               |   |               |     |                 |      |                 |       |                 |
| 0-250mV [0.25u] | 2.15kΩ                    | 0.0 to 250.0 (fixed)   |                        |  |      |               |   |               |     |                 |      |                 |       |                 |
| 0-50mV [50nu]   | 2.15kΩ                    | 0.00 to 50.00 (fixed)  |                        |  |      |               |   |               |     |                 |      |                 |       |                 |
| DC current      | 0-5A [5A]                 | 0.01Ω                  | 0.000 to 5.000 (fixed) |  |      |               |   |               |     |                 |      |                 |       |                 |
|                 | 0-2A [2A]                 | 0.01Ω                  | 0.000 to 2.000 (fixed) |  |      |               |   |               |     |                 |      |                 |       |                 |
|                 | 0-500mA [0.5A]            | 0.1Ω                   | 0.0 to 500.0 (fixed)   |  |      |               |   |               |     |                 |      |                 |       |                 |
|                 | 0-200mA [0.2A]            | 0.1Ω                   | 0.0 to 200.0 (fixed)   |  |      |               |   |               |     |                 |      |                 |       |                 |
|                 | 0-50mA [50na]             | 1.0Ω                   | 0.00 to 50.00 (fixed)  |  |      |               |   |               |     |                 |      |                 |       |                 |
|                 | 4-20mA [4-20]             | 1.0Ω                   | 4.00 to 20.00 (fixed)  |  |      |               |   |               |     |                 |      |                 |       |                 |
|                 | 0-5mA [5na]               | 10.0Ω                  | 0.000 to 5.000 (fixed) |  |      |               |   |               |     |                 |      |                 |       |                 |
|                 | 0-2mA [2na]               | 10.0Ω                  | 0.000 to 2.000 (fixed) |  |      |               |   |               |     |                 |      |                 |       |                 |
| AC voltage      | 0-500V [500u]             | 4.98MΩ                 | 0.0 to 500.0 (fixed)   |  |      |               |   |               |     |                 |      |                 |       |                 |
|                 | 0-250V [250u]             | 4.98MΩ                 | 0.0 to 250.0 (fixed)   |  |      |               |   |               |     |                 |      |                 |       |                 |
|                 | 0-110V [110P]             | 1.08MΩ                 | 0.0 to 440.0 (fixed)   |  |      |               |   |               |     |                 |      |                 |       |                 |
|                 | 0-50V [50u]               | 1.08MΩ                 | 0.00 to 50.00 (fixed)  |  |      |               |   |               |     |                 |      |                 |       |                 |
|                 | 0-20V [20u]               | 200kΩ                  | 0.00 to 20.00 (fixed)  |  |      |               |   |               |     |                 |      |                 |       |                 |
|                 | 0-10V [10u]               | 200kΩ                  | 0.00 to 10.00 (fixed)  |  |      |               |   |               |     |                 |      |                 |       |                 |
|                 | 0-2V [2u]                 | 20kΩ                   | 0.000 to 2.000 (fixed) |  |      |               |   |               |     |                 |      |                 |       |                 |
|                 | 0-1V [1u]                 | 20kΩ                   | 0.000 to 1.000 (fixed) |  |      |               |   |               |     |                 |      |                 |       |                 |
| AC current      | 0-5A [5A]                 | 0.01Ω                  | 0.000 to 5.000 (fixed) |  |      |               |   |               |     |                 |      |                 |       |                 |
|                 | 0-2.5A [2.5A]             | 0.01Ω                  | 0.000 to 2.500 (fixed) |  |      |               |   |               |     |                 |      |                 |       |                 |
|                 | 0-1A [1A]                 | 0.05Ω                  | 0.000 to 1.000 (fixed) |  |      |               |   |               |     |                 |      |                 |       |                 |
|                 | 0-500mA [0.5A]            | 0.1Ω                   | 0.0 to 500.0 (fixed)   |  |      |               |   |               |     |                 |      |                 |       |                 |
|                 | 0-250mA [0.25A]           | 0.1Ω                   | 0.0 to 250.0 (fixed)   |  |      |               |   |               |     |                 |      |                 |       |                 |
|                 | 0-100mA [0.1A]            | 0.5Ω                   | 0.0 to 100.0 (fixed)   |  |      |               |   |               |     |                 |      |                 |       |                 |
| 0-50mA [50na]   | 0.5Ω                      | 0.00 to 50.00 (fixed)  |                        |  |      |               |   |               |     |                 |      |                 |       |                 |



## ■ Sold Separately

### ◎ Communication converter

#### ● SCM-WF48

(Wi-Fi to RS485-USB wireless communication converter)



#### ● SCM-US48I

(USB to RS485 converter)



#### ● SCM-38I

(RS232C to RS485 converter)



### ◎ Display Units (DS/DA-T Series)

#### ● DS/DA-T Series

(RS485 communication input type display unit) CE



DS16-□T



DS22/DA22-□T



DS40/DA40-□T



DS60/DA60-□T

※Connect RS485 communication input type display unit (DS/DA-T Series) and RS485 communication output model of MT4Y/MT4W Series, the display unit displays present value of the device without PC/PLC.

## ■ Functions

### ◎ AC frequency measurement

#### [PA 1 group: $d15P$ ]

It measures input signal frequency when it is AC input. It uses fixed decimal point [PA1:  $d0E$ ], measured range can be changed by setting and measured range of decimal point position is as below chart. It is available to adjust the upper gradient at [PA 1:  $inbH$ ] and [PA 1:  $inbE$ ]. In order to measure frequency normally, input signal, over 10% F.S. of the measured range, should be supplied. Please select the proper point of

#### ① Measuring range

| Decimal point position | 0.000            | 0.00            | 0.0            | 0           |
|------------------------|------------------|-----------------|----------------|-------------|
| Measurement range      | 0.100 to 9.999Hz | 0.10 to 99.99Hz | 0.1 to 999.9Hz | 1 to 9999Hz |

※Accuracy of frequency measurement:

Below 1kHz, F.S.  $\pm 0.1rdg \pm 2$ -digit.

From 1kHz to 10kHz, F.S.  $\pm 0.3rdg \pm 2$ -digit.

②  $inbH$ : 0.100 to 9.999 [Gradient adjustment of high value]

③  $inbE$ :  $10^2, 10^{-1}, 10^0, 10^1$  [Index adjustment of  $inbH$ ]

### ◎ Zero adjustment

#### [Deviation correction function of low limit display value]

It adjusts the display value of the optional configured input value as zero by force, zero point error can be adjusted with 3 ways as below. When zero point adjustment with front key and Hold terminal is finished normally, zero point of measurement terminal is displayed and the adjusted value at saved in  $inbL$  automatically.

| Operation   | Input correction value                                 | Front panel key   | Input external signal  |
|-------------|--|---|--|
| Description | PA 1: Direct input correction value method at $inbL$ . | Press $\leftarrow$ , $\rightarrow$ key for 3 sec at the RUN mode. | Short-circuit external Hold terminal 11, 12 [6, 7 (MT4W)] over min. 50m. |

※Refer to "◎ Error correction", "◎ Error display" and "■ Parameter 2 Group" for function and error.

### ◎ Transmission (DC4-20mA) output scale

#### [PA2 group: $F5-H / F5-L$ ]

It sets transmission output for the display value at the output current DC4-20mA.

It sets display value for 4mA at  $F5-L$  and 20mA at  $F5-H$  and the range between  $F5-H$  and  $F5-L$  should be 10%

※When min. set interval between  $F5-H$  and  $F5-L$  is set as under 10% F.S., it changed as over 10% F.S. automatically.

※Preset display value is fixed to output as 4mA at under  $F5-L$  and 20mA at over  $F5-H$ .

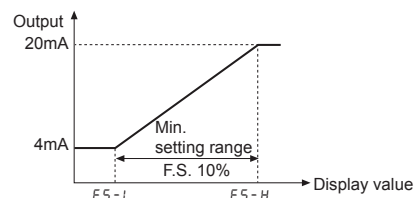

|     |   |
|-----|---|
| (A) | Photoelectric Sensors   |
| (B) | Fiber Optic Sensors   |
| (C) | Door/Area Sensors   |
| (D) | Proximity Sensors   |
| (E) | Pressure Sensors  |
| (F) | Rotary Encoders   |
| (G) | Connectors/ Connector Cables/ Sensor Distribution Boxes/Sockets |
| (H) | Temperature Controllers   |
| (I) | SSRs / Power Controllers  |
| (J) | Counters  |
| (K) | Timers  |
| (L) | Panel Meters  |
| (M) | Tacho / Speed / Pulse Meters                                    |
| (N) | Display Units   |
| (O) | Sensor Controllers  |
| (P) | Switching Mode Power Supplies                                   |
| (Q) | Stepper Motors & Drivers & Controllers                          |
| (R) | Graphic/ Logic Panels   |
| (S) | Field Network Devices   |
| (T) | Software  |

# MT4Y/MT4W Series

## Initialization

It initializes as the factory default status. If press  $\leftarrow$ ,  $\rightarrow$ ,  $\checkmark$  keys together for 2 sec in **RUN** mode,  $i_{nbL}$  mode and the setting value ( $n_0$ ) is displayed every 0.5 sec and it will be initialized as the factory default when press  $\text{MODE}$  key after change  $n_0 \rightarrow 9E5$ .

## Startup compensation time [PA 2 group: $5tRt$ ]

This time function limits the operation of an output until the measured input (overvoltage or inrush current) is stable at moment of power on. All outputs are off during startup compensation time setting after power is applied.  
Setting range: 00.0 to 99.9 (unit: sec)  
Factory default: 00.0

## Error display

| Display | Description  |
|---------|--|
| HHHH    | Flashes when measuring input is exceeded the max. allowable input (110%)     |
| LLLL    | Flashes when measuring input is exceeded the max. allowable input (-10%)     |
| d-HH    | Flashes when display input is exceeded the max. display range (9999)         |
| d-LL    | Flashes when display input is exceeded the min. display range (-1999)        |
| F-HH    | Flashes when measuring frequency is exceeded the max. measuring value (9999) |
| ouEr    | Flashes when it exceeds zero adjustment range ( $\pm 99$ )                   |

※ Error display is released automatically when it is in the measured and display range.

※ "LLLL" is displayed when the measuring input is DC4-20mA.

※ After flashing "ouEr" 2 times when it exceeds the zero adjustment range, it returns to RUN mode.

## Display scale [PA 1 group: $H-5C/L-5C$ ]

This function is to display setting (-1999 to 9999) of particular High/Low-limit value in order to display High/Low-limit value of measured input. If measured inputs are 'a' and 'b' and particular values are 'A' and 'B', it will display  $a=A$ ,  $b=B$  as below graphs.

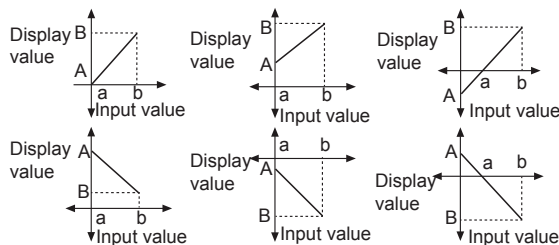

## Gradient correction [PA 1 group: $i_{nbH}$ ]

This function is to correct a gradient of prescale value and display value. (Fig.1) Display value Y can be used as  $\alpha$ ,  $\beta$  times against X input value by correction function [ $i_{nbH}$ ]. And also can be used as correction function of max. display value ( $H-5C$ ). Adjustment range is 0.100 to 5.000 and multiply current gradient.

E.g.) Input: DC200mV, Display: 3.000 for MT4W-DV

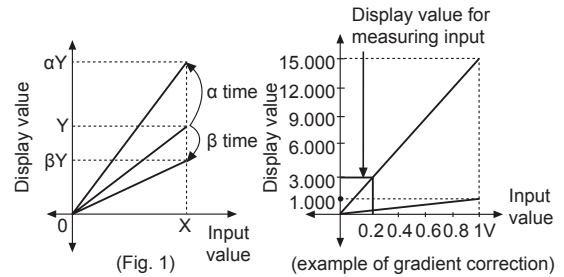

- Select 0-1VDC [ $I_u$ ] for measuring input in Parameter1.
- Standard specification in input: 0-1VDC and 1.000 therefore it has to be 15.000 ( $H-5C$ ) for 1VDC (input) in order to display 3.000 for DC200mV (input). But it is disable due to setting range is 9.999
- In this case, please check below chart. Please set as  $i_{nbH} \times H-5C = 15.000$

| Setting | $H-5C$  | $L-5C$ | $i_{nbH}$ | Other   |
|---------|---------|--------|-----------|---|
| ①       | Disable | 0.000  | 1.000     | —   |
| ②       | 7.500   | 0.000  | 2.000     | In this case, any setting methods display the same display value. |
| ③       | 5.000   | 0.000  | 3.000     |   |
| ④       | 3.750   | 0.000  | 4.000     |   |
| ⑤       | 3.000   | 0.000  | 5.000     |   |

## Error correction [PA 1 group: $i_{nbH} / i_{nbL}$ ]

It corrects display value error of measured input.

$i_{nbL}$ :  $\pm 99$  [Adjust deviation of low value]

$i_{nbH}$ : 5.000 to 0.100 [Correct gradient (%) of high value]

Display value = (measured value  $\times i_{nbH}$ ) +  $i_{nbL}$

E.g.) When the measured range is 0 to 500V, and the display range is 0 to 500.0. If the low display value is "1.2" to 0V input, set -12 as  $i_{nbL}$  value to display "0.0" by adjusting offset of the low value. The display value to 500V measured input varies by adjusting the offset of low value. If this display value is "501.0", calculate  $500.0/501.0$  (desired display value/the display value), and set the 0.998 correction value as the  $i_{nbH}$  to display 500.0 by adjusting gradient of high value.

※ The offset correction range of  $i_{nbL}$  is within -99 to 99 for  $D^0, D^{-1}$  digit regardless of decimal point.

## Display cycle delay [PA 2 group: $d15t$ ]

In some applications the measured input may fluctuate which in turn causes the display to fluctuate. By adjusting the display cycle delay function time in the  $d15t$  of parameter 2, the operator can adjust the display time within a range of 0.1 sec to 5 sec. For example, if the operator sets the display cycle time to 4.0 sec, the display value displayed will be the average input value over 4 sec and also will show any changes if any every 4 sec.

## Monitoring peak display value

[PA 0 group:  $HPEL/LPEL$ , PA 2 group:  $PEL$  ]

It monitors max./min. value of display value based on the current displays value and then displays the data at  $HPEL$ ,  $LPEL$  of parameter 0. Set the delay time (0 to 30 sec) at  $PEL$  of parameter 2 in order to prevent malfunction caused by initial overcurrent or overvoltage, when monitoring the peak value.

Delay time is 0 to 30 sec and it starts to monitor the peak value after the set time. When pressing any one of  $\leftarrow$   $\rightarrow$   $\uparrow$   $\downarrow$  keys at  $HPEL$ ,  $LPEL$  of parameter 0, the monitored data is initialized.

※ $HPEL$ ,  $LPEL$  parameters is not displayed when monitoring delay time [ $PEL$ ] of parameter 2 group is set as 00 sec [00 5].

## Preset output operation mode

[PA 2 group:  $oUte$  ]

| Mode   | Output operation | Operation   |
|--------|------------------|---|
|        |                  |   |
| $oFF$  |                  | No output   |
| $L5t$  |                  | If it is equal or smaller than low setting value, LO output will be ON. If it is bigger than low setting value, GO output will be ON.   |
| $H5t$  |                  | If it is equal or bigger than high setting value, HI output will be ON. If it is equal or smaller than high setting value, GO output will be ON.  |
| $LH5t$ |                  | If it is equal or smaller than low setting value and equal or bigger than high setting value, the output will be ON. If it is bigger than Low setting value and smaller than high setting value, GO output will be ON.                |
| $HH5t$ |                  | If it is equal or bigger than low set and equal or bigger than high set value, output will be ON. If it is smaller than low setting value and high setting value, GO output will be ON.   |
| $L5t$  |                  | If it is equal or smaller than low setting value, LO output will be ON. If it is equal or smaller than high setting value, HI output will be ON. If it is bigger than low setting value and High setting value, GO output will be ON. |
| $Ld5t$ |                  | This operation is the same as $L5t$ But it doesn't operate at initial low set value, it will operate at next low set value. If this is higher than low set value, Go output will be ON.   |

※"H" means hysteresis and able to set 1 to 99 at "H55" mode in PA 2 among above comparison output chart.

※ $H5t$  is displayed according to the setting of output operation mode, when user sets " $oFF$ ",  $H5t$  /  $L5t$  are not displayed.

※Only  $L5t$  setting is available in MT4Y-□-43 and MT4Y-□-44 models.

## Sub output

• RS485 communication output

It is able to set address (01 to 99)

It is able to transmit by selecting modulation speed (transmitted number of signal per 1 sec) of serial transmission. (selectable 1200, 2400, 4800, 9600bps)

• Low-speed serial output

It outputs current display value as Low-frequency (50Hz) type.

• Transmission (DC4-20mA) output

It outputs DC4-20mA against High/Low-limit scale. (resolution: 12000 division)

• BCD dynamic output

It outputs display value as BCD Code.

※**Only one sub-output is selectable.**

(More than one sub-output is not allowed.)

## Time chart of BCD dynamic output and Serial output

• BCD dynamic output (negative logic)

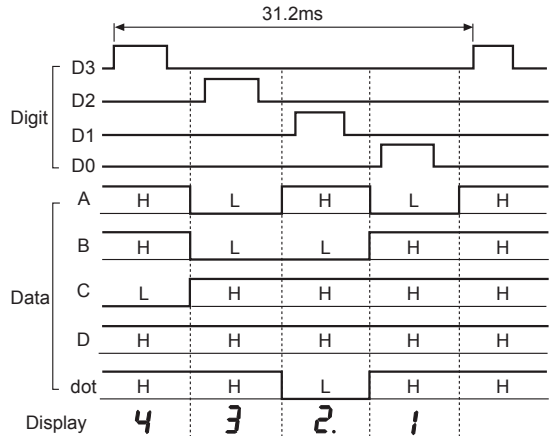
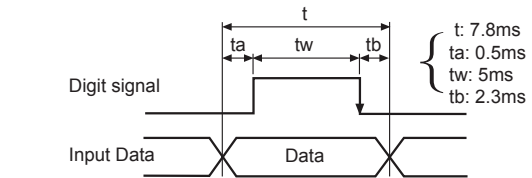

• Serial output (negative logic)-Clock frequency:50Hz

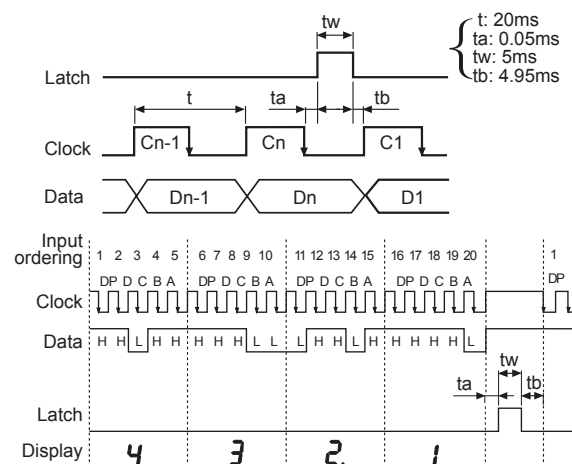

|     |   |
|-----|---|
| (A) | Photoelectric Sensors   |
| (B) | Fiber Optic Sensors   |
| (C) | Door/Area Sensors   |
| (D) | Proximity Sensors   |
| (E) | Pressure Sensors  |
| (F) | Rotary Encoders   |
| (G) | Connectors/ Connector Cables/ Sensor Distribution Boxes/Sockets |
| (H) | Temperature Controllers   |
| (I) | SSRs / Power Controllers  |
| (J) | Counters  |
| (K) | Timers  |
| (L) | Panel Meters  |
| (M) | Tacho / Speed / Pulse Meters                                    |
| (N) | Display Units   |
| (O) | Sensor Controllers  |
| (P) | Switching Mode Power Supplies                                   |
| (Q) | Stepper Motors & Drivers & Controllers                          |
| (R) | Graphic/ Logic Panels   |
| (S) | Field Network Devices   |
| (T) | Software  |