

DP-M SERIES

onlinecomponents.com
THE ONLINE DISTRIBUTOR OF ELECTRONIC COMPONENTS

Micro-differential Pressure High-precision Digital Pressure Sensor

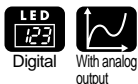

High accuracy & resolution



High accuracy and resolution

Due to differential pressure sensing, the pressure can be set with a high resolution of 0.01 kPa.D {1 mmH₂O.D} over a pressure range of 0 to 2.00 kPa.D {0 to 204 mmH₂O.D} and, moreover, the detection accuracy is within $\pm 1\%$ F.S.

Bright display • easy key operation

Three bright red 7-segment LEDs, 12 mm 0.472 in high, are incorporated in the compact body. They can be clearly read not only in a dark place, but also, in a well-lit place. Further, initialization or pressure settings can be easily done with key operation while looking at the display.

Pressure unit selectable

The pressure unit can be selected from 'kPa' and 'mmH₂O' according to your requirement. Further, during measurement, the pressure unit can be recognized at a glance from the pressure unit indicator.

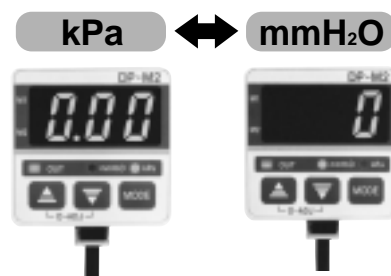

(When the pressure unit is changed, threshold values and the measured pressure value are automatically converted.)

Setting resolution

**0.01 kPa.D
{1 mmH₂O.D}**

Repeatability

Within $\pm 1\%$ F.S.



Versatile control with two output modes

1 Hysteresis mode

The lower threshold value and the upper threshold value establish the hysteresis of the comparative output.

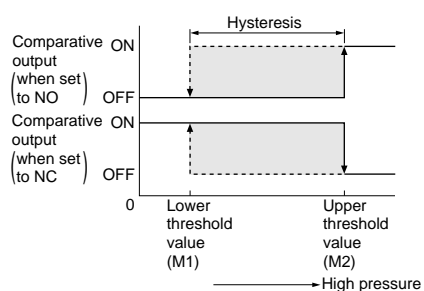

2 Window comparator mode

The comparative outputs can be made ON or OFF by a pressure within the limits set by the upper and the lower threshold levels.

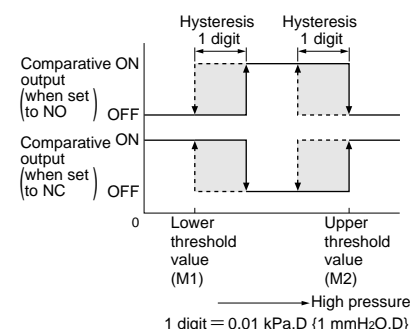

Analog current output type: DP-M2A

DP-M2A is incorporated also with the analog current output (4 to 20 mA). Hence, it is ideally suited for real time monitoring and multi-point control in combination with an analog controller (ultra-compact digital panel controller CA2 series, or digital panel controller CA series).

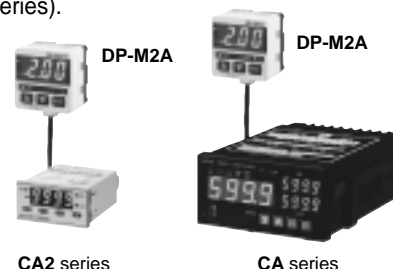

Digital panel controller

APPLICATIONS

Detecting clogging of filter

The clogging of a filter can be reliably detected by the differential pressure, indicating the time for filter replacement.

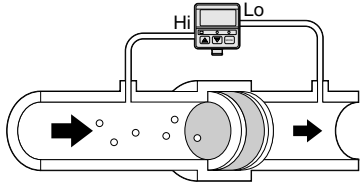

Detecting liquid level with air supply

The air supply pressure varies with the depth of the pipe in the liquid, and hence, the liquid level can be detected.

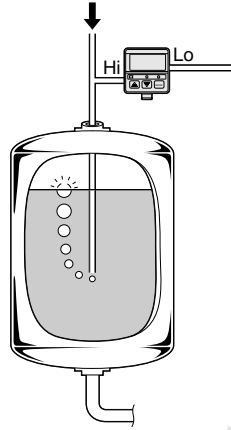

ORDER GUIDE

Type	Appearance	Rated pressure range	Model No.	Pressure port	Output
Standard		0 to 2.00 kPa.D {0 to 204 mmH ₂ O.D}	DP-M2	φ 4.8 mm φ 0.189 in resin pipe	NPN open-collector transistor
With analog current output		0 to 2.00 kPa.D {0 to 204 mmH ₂ O.D}	DP-M2A		

OPTIONS

Designation	Model No.	Description	
Sensor mounting bracket	MS-PE-1	L-shaped bracket [Two M3 (length 8 mm 0.315 in) screws with washers are attached.]	
Panel mounting bracket	MS-PE-2	It can be used for mounting on a panel (1 to 3.2 mm 0.039 to 0.126 in thick). [Two M3 (length 8 mm 0.315 in) screws with washers are attached.]	
Front protection cover	MS-PE-3	It protects the sensor's adjustment panel. (It can be fitted when the panel mounting bracket is used.)	
Digital panel controller (Note)	CA2-T1	NPN open-collector transistor	This is a very small controller which allows two independent threshold level settings. • Supply voltage: 24 V DC \pm 10 % • No. of inputs: 1 No. (sensor input) • Input range: 4 to 20 mA • Main functions: Threshold level setting function, zero-adjust function, scale setting function, hysteresis setting function, start / hold function, auto-reference function, power supply ON-delay function, etc.
	CA-R1	Relay contact	This is a multi-functional controller having mathematical functions, hold function, etc. • Supply voltage: 100 to 240 V AC \pm 10 % • No. of inputs: 2 Nos. (sensor inputs) • Input range: 4 to 20 mA • Power supply for sensor: 12 V DC, 150 mA • Main functions: Mathematical functions, process number selection function, hold function, scaling function, auto-reference function, power supply ON-delay function, measurement start delay function, hysteresis setting function, etc.
	CA-T1	NPN open-collector transistor	
	CA-B1	NPN open-collector transistor With BCD output	

Note: For further details, refer to p.864~ for the ultra-compact digital panel controller **CA2** series, and to p.854~ for the digital panel controller **CA** series.

Sensor mounting bracket

- MS-PE-1

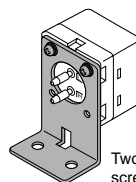

Two M3 (length 8 mm 0.315 in) screws with washers are attached.

Panel mounting bracket, Front protection cover

- MS-PE-2
- MS-PE-3

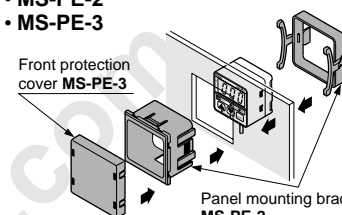

Panel mounting bracket **MS-PE-2**
(Suitable for 1 to 3.2 mm 0.039 to 0.126 in thick panel)

Digital panel controller

- CA2 series



- CA series



SPECIFICATIONS

Item	Type	Standard type	With analog current output type
	Model No.	DP-M2	DP-M2A
Type of pressure		Differential pressure	
Rated pressure range		0 to 2.00 kPa.D {0 to 204 mmH ₂ O.D}	
Set pressure range		0 to 2.00 kPa.D {0 to 204 mmH ₂ O.D}	
Set pressure resolution		0.01 kPa.D {1 mmH ₂ O.D}	
Pressure withstandability		6 kPa.D {612 mmH ₂ O.D}	
Applicable fluid		Non-corrosive gas	
Selectable units		kPa, mmH ₂ O	
Supply voltage		12 to 24 V DC $^{+10}_{-15}$ % Ripple P-P 10 % or less	
Current consumption		50 mA or less	75 mA or less
Comparative output		NPN open-collector transistor • Maximum sink current: 100 mA • Applied voltage: 30 V DC or less (between comparative output and 0 V) • Residual voltage: 1 V or less (at 100 mA sink current) 0.4 V or less (at 16 mA sink current)	
	Utilization category	DC-12 or DC-13	
	Output operation	Selectable either normally open (NO) or normally closed (NC) by the key (Note)	
	Hysteresis	0.01 kPa.D {1 mmH ₂ O.D}	
	Repeatability	Within ± 1 % F.S.	
	Response time	10 ms or less	
	Short-circuit protection	Incorporated	
Analog current output			Output current: 4 to 20 mA (from 0 to 1.96 kPa.D {0 to 200 mmH ₂ O.D}) Zero-point: within 4 mA ± 1 % F.S. Span: within 16 mA ± 3 % F.S. Linearity: within ± 1 % F.S. Load resistance: 0 to 250 Ω
Display		3 digit red LED display (Sampling rate: 4 times/sec. approx.)	
Indicator	Displayable pressure range	- 0.05 to 2.10 kPa.D { - 5 to 210 mmH ₂ O.D}	
	Operation	Orange LED (lights up when the comparative output is ON)	
	Pressure unit	Red LED (The indicator corresponding to the selected unit lights up during the sensing mode.)	
	M1 setting	Red LED (blinks in the M1 setting mode)	
	M2 setting	Red LED (blinks in the M2 setting mode)	
Environmental resistance	Pollution degree	3 (Industrial environment)	
	Ambient temperature	0 to + 50 °C + 32 to + 122 °F (No dew condensation), Storage: - 10 to + 60 °C + 14 to + 140 °F	
	Ambient humidity	35 to 85 % RH, Storage: 35 to 85 % RH	
	EMC	EN 50081-2, EN 50082-2, EN 61000-6-2	
	Voltage withstandability	1,000 V AC for one min. between all supply terminals connected together and enclosure	
	Insulation resistance	50 M Ω , or more, with 500 V DC megger between all supply terminals connected together and enclosure	
	Vibration resistance	10 to 150 Hz frequency, 0.75 mm 0.030 in amplitude in X, Y and Z directions for two hours each	
Shock resistance	100 m/s ² acceleration (10 G approx.) in X, Y and Z directions for three times each		
Temperature characteristics		Over ambient temperature range 0 to + 50 °C + 32 to + 122 °F: within ± 3 % F.S. of detected pressure at + 25 °C + 77 °F	
Pressure port		ϕ 4.8 mm ϕ 0.189 in resin pipe	
Material		Front case: ABS, Rear case: ABS, LED display: Acrylic, Pressure port: PA	
Cable		0.18 mm ² 3-core oil resistant cabtyre cable, 2 m 6.562 ft long	0.18 mm ² 4-core oil resistant cabtyre cable, 2 m 6.562 ft long
Cable extension		Extension up to total 100 m 328.084 ft (less than 10 m 32.808 ft when conforming to CE marking) is possible with 0.3 mm ² , or more, cable.	
Weight		75 g approx.	

Note: Refer to 'Setting procedure' of PRECAUTIONS FOR PROPER USE on p.828 for more details.

DP-M

onlinecomponents.com
THE ONLINE DISTRIBUTOR OF ELECTRONIC COMPONENTS

I/O CIRCUIT AND WIRING DIAGRAMS

DP-M2

Standard type

I/O circuit diagram

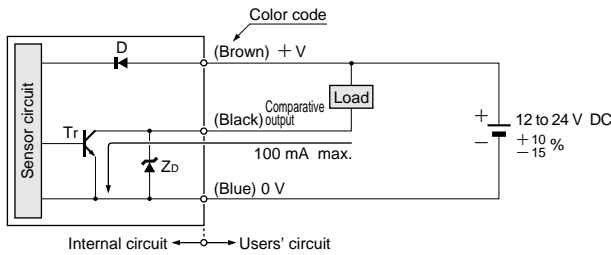

Symbols ... D : Reverse supply polarity protection diode
Z₀: Surge absorption zener diode
Tr : NPN output transistor

Wiring diagram

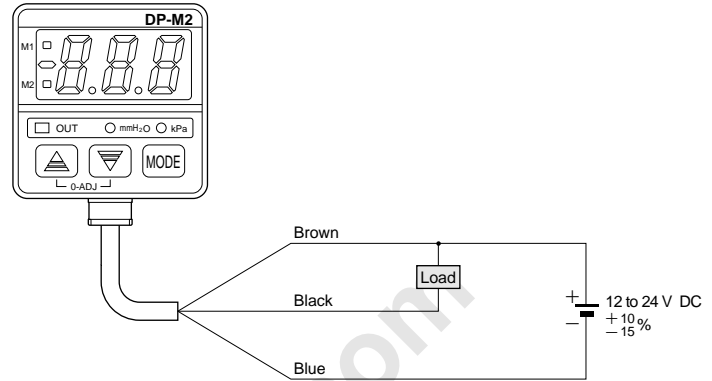

DP-M2A

With analog current output type

I/O circuit diagram

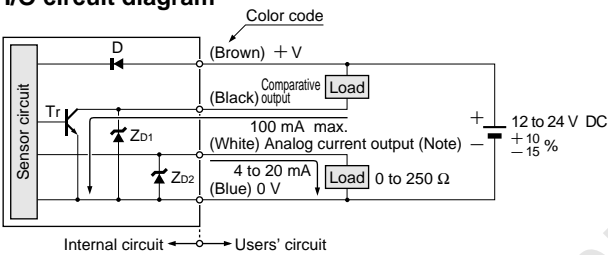

Note: The analog current output does not incorporate a short-circuit protection circuit. Do not connect it directly to a power supply or capacitive load.

Symbols ... D: Reverse supply polarity protection diode
Z₀₁, Z₀₂: Surge absorption zener diode
Tr : NPN output transistor

Wiring diagram

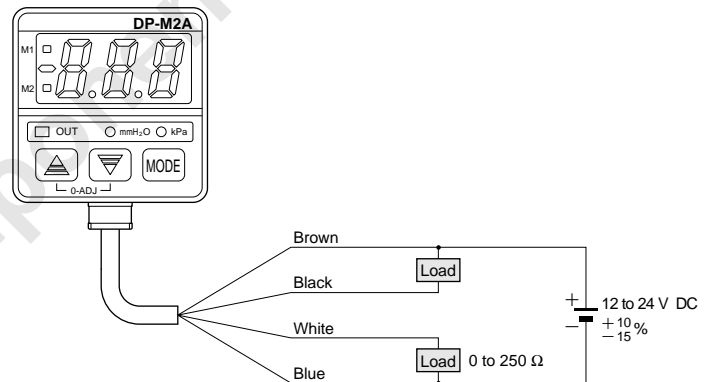

PRECAUTIONS FOR PROPER USE



- This product is not a safety sensor. Its use is not intended or designed to protect life and prevent body injury or property damage from dangerous parts of machinery. It is a normal pressure detection sensor.
- The **DP-M** series is designed for use with non-corrosive gas. It cannot be used for liquid or corrosive gas.

Operation

- If setting is impossible even with pressing the MODE key, verify whether the key-protect function is enabled. Please note that pressing down on the MODE key for an extended moment will enable the key-protect function as soon as the key is released.
- If using the window comparator mode, lower threshold value (M1) and upper threshold value (M2) should be set with a difference of 3 digits (0.03 kPa.D {3 mmH₂O.D}) or more. No output will be possible with a 0 to 2 digit difference.

Conditions in use for CE conformity

- The **DP-M** series is a CE conformity product complying with EMC Directive. The harmonized standard with regard to immunity that applies to this product is EN 61000-6-2 (Note) and the following condition must be met to conform to that standard.

Condition

- The sensor should be connected less than 10 m 32.808 ft from the power supply.

Note: The EN 50082-2 that previously applied to the products for conforming to EMC Directive was replaced by EN 61000-6-2 starting April 1st, 2002.

Mounting

- The displayed value may vary by 1 digit (0.01 kPa.D {1 mmH₂O.D}) maximum depending on whether the sensor is installed vertically or horizontally.
- A sensor mounting bracket **MS-PE-1** (optional) may be used. When mounting the sensor with the sensor mounting bracket, etc., the tightening torque should be 0.5N·m or less.

M3 (length 8 mm 0.315 in) screw with washers
(Accessory for **MS-PE-1**)

Sensor mounting bracket
MS-PE-1 (Optional)

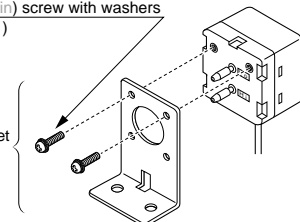

PRECAUTIONS FOR PROPER USE

Piping

• Apply higher pressure to the Hi-port and lower pressure to the Lo-port.

• Use flexible silicone tubes that can fit the $\phi 4.8$ mm $\phi 0.189$ in ports. The tubes should cover more than half the length of the pressure ports.

Recommended silicone tube

- LABORAN® silicone tube, size: internal dia 4 mm 0.157 in, external dia 6 mm 0.236 in, made by Tigers Polymer.
- TYGON® tube R-3603, size: internal dia 4 mm 0.157 in, external dia 6 mm 0.236 in, made by NORTON.

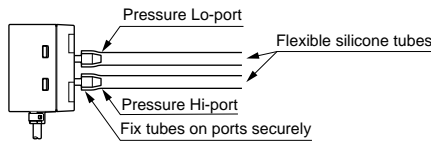

- Notes: 1) LABORAN and TYGON are registered trademarks of Tigers Polymer and NORTON, respectively.
- 2) Ensure that excessive pressure is not applied to the pressure ports. Since this sensor is designed for detecting small pressures, if excessive pressure or shock is applied to the pressure ports, the diaphragm (pressure sensing device) in the sensor may get damaged.
 - 3) Please do not compress the silicone tube. If the silicone tube is compressed, pressure exceeding the rated value may be generated, damaging the diaphragm (pressure sensing device).

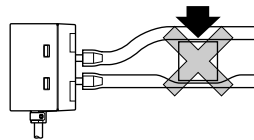

Wiring

- Make sure that the power supply is off while wiring.
- Verify that the supply voltage variation is within the rating.
- If power is supplied from a commercial switching regulator, ensure that the frame ground (F.G.) terminal of the power supply is connected to an actual ground.
- In case noise generating equipment (switching regulator, inverter motor, etc.) is used in the vicinity of this sensor, connect the frame ground (F.G.) terminal of the equipment to an actual ground.
- Do not run the wires together with high-voltage lines or power lines or put them in the same raceway. This can cause malfunction due to induction.
- The analog current output does not incorporate a short-circuit protection circuit. Do not connect it directly to a power supply or a capacitive load.

Others

- Use within the rated pressure range.
- Do not apply pressure exceeding the pressure withstandability value. The diaphragm will get damaged and correct operation shall not be maintained.
- Do not use during the initial transient time (0.5 sec.) after the power supply is switched on.
- Avoid dust, dirt, and steam.
- Take care that the sensor does not come in direct contact with water, oil, grease, or organic solvents, such as, thinner, etc.
- Do not insert wires, etc., into the pressure port. The diaphragm will get damaged and correct operation shall not be maintained.
- Do not operate the keys with pointed or sharp objects.

Functional description

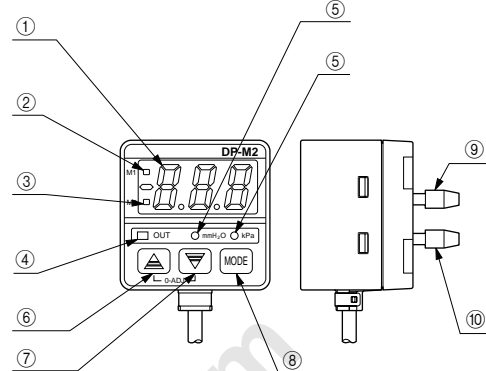

	Description	Function
①	3 digit LED display (Red)	The measured differential pressure level, setting values, error codes, and key protection sign are displayed.
②	M1 setting indicator (Red)	Blinks in the lower threshold value (M1) setting mode.
③	M2 setting indicator (Red)	Blinks in the upper threshold value (M2) setting mode.
④	Operation indicator (Orange)	Lights up when the comparative output is ON.
⑤	Pressure unit indicator (mmH ₂ O, kPa) (Red)	<ul style="list-style-type: none"> • The indicator of the selected unit lights up during the sensing mode. • Both indicators light off during the initial setting mode and during an error occurrence. • The indicator of the selected unit blinks during the upper and lower threshold value setting mode.
⑥	Increment key (▲)	<ul style="list-style-type: none"> • The settable digit is shifted cyclically at every press of the key during the initial setting mode. • Pressing the key increases the set value, in the upper and lower threshold value setting mode.
⑦	Decrement key (▼)	<ul style="list-style-type: none"> • The set condition changes at every press of the key during the initial setting mode. • Pressing the key decreases the set value, in the upper and lower threshold value setting mode.
⑧	Mode selection key (MODE)	<ul style="list-style-type: none"> • Three modes, the sensing mode, the lower threshold value (M1) setting mode, and the upper threshold value (M2) setting mode, are cyclically selected at every press of the key. • During the sensing mode, pressing the key for 4 sec., or more, can make the key protection either effective or ineffective. • Holding the increment key and simultaneously pressing the mode selection key brings the sensor from the sensing mode to the initial setting mode.
⑨	Pressure Lo-port	Lower pressure should be applied.
⑩	Pressure Hi-port	Higher pressure should be applied.

Error messages

• When an error occurs, take the following corrective action.

Error message	Cause	Corrective action
	Overcurrent due to short-circuit.	Switch off the power supply and check the load.
	Pressure (differential pressure) is being applied during zero-point adjustment.	Applied pressure at the Hi-port and the Lo-port should be brought to atmospheric pressure and zero-point adjustment should be done again.
	Applied pressure (differential pressure) exceeds the upper limit of displayable pressure range (2.10 kPa.D {210 mmH ₂ O.D})	Applied pressure should be brought within the rated pressure range.
	Applied pressure (differential pressure) exceeds the lower limit of displayable pressure range (-0.05 kPa.D {-5 mmH ₂ O.D}).	(0 to 2.00 kPa.D {0 to 204 mmH ₂ O.D})

DP-M

PRECAUTIONS FOR PROPER USE

Setting

- If key-protect has been set, make sure to release key-protect before operating the keys.
(Please refer to 'Key-protect function' on p.829 for the procedure.)
- The conditions which are set are stored in an EEPROM. Kindly note that the EEPROM has a life span and its guaranteed life is 100,000 write operation cycles.

Setting procedure

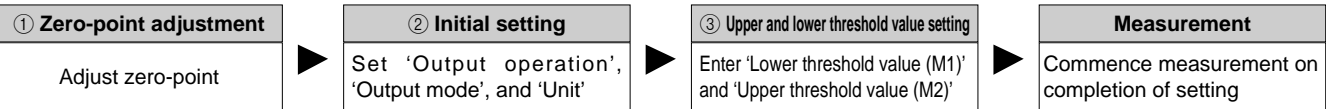

① Zero-point adjustment

- The displayed differential pressure when the pressure port is left open is adjusted to zero.

Set to sensing mode

- The sensor will automatically enter the sensing mode when power is supplied.
- The figure on the left shows the display when the pressure unit is set to 'mmHzO'.
- $\overline{000}$ is displayed if the pressure unit is set to 'kPa'.

Perform zero-point adjustment

- Let the pressure ports (Hi-port and Lo-port) be at atmospheric pressure (i.e., no applied pressure condition), and press, simultaneously, Δ key and ∇ key continuously.
- $\overline{000}$ is displayed and, when the fingers are released, zero-point adjustment is completed and the sensor returns to the sensing mode.
- When the unit of 'kPa' has been selected, $\overline{000}$ blinks once after the keys are released.

- If pressure has been applied during zero-point adjustment, $\overline{E-3}$ is displayed when the keys are pressed. Bring the applied pressure to atmospheric pressure (i.e., no applied pressure condition) and carry out the zero-point adjustment once again.

② Initial setting

- 'Output operation' and 'Output mode' of the comparative outputs, and pressure 'Unit' are set.

Set to initial setting mode

- In the sensing mode, press \square key while pressing Δ key.
- Initial setting is displayed.
- If sensor is being used for the first time, \overline{UxHx} is displayed.

Set initial conditions

- The settable digit blinks.
- The settable digit changes when Δ key is pressed.
- Change the setting of each digit as desired.
- The setting is changed when ∇ key is pressed.

Change with Δ key.

3rd digit	2nd digit	1st digit
U	H	0
↓	↓	↓
P	E	E
...
Unit	Output operation	Output mode
U: mmHzO	B: Normally open (NO)	H: Hysteresis mode
P: kPa	E: Normally closed (NC)	E: Window comparator mode

Set to sensing mode

- Press \square key.
- Your set data is registered and the sensor enters into the sensing mode.
- The above figure shows the display when the pressure unit is set to 'mmHzO'.

• Output mode and output operation

Hysteresis mode (H) (M1 < M2)

Window comparator mode (E) (M1 < M2)

1 digit = 0.01 kPa.D
{ 1 mmHzO.D }

- When operating in window comparator mode (E) lower threshold value (M1) and upper threshold value (M2) should be set with a difference of 3 digits (0.03 kPa.D { 3 mmHzO.D }) or more.

PRECAUTIONS FOR PROPER USE

③ Upper and lower threshold value setting

- 'Lower threshold value (M1)' and 'upper threshold value (M2)' of the comparative outputs are set.

• The lower threshold value (M1) and the upper threshold value (M2) can be entered under the following conditions.
M1 < M2
No vacuum values

Set to lower threshold value (M1) set mode	Enter lower threshold value (M1)	Set to upper threshold value (M2) set mode	Enter upper threshold value (M2)	Set to sensing mode
<ul style="list-style-type: none"> • In the sensing mode, press MODE key. • The registered lower threshold value (M1) appears and blinks. The M1 setting indicator and the pressure unit indicator also blink. 	<ul style="list-style-type: none"> • Enter using ▲ key and ▼ key. • If ▲ key is pressed once, the set value increases by 1 digit and if ▼ key is pressed once, the set value decreases by 1 digit. Further, if ▲ key or ▼ key is pressed continuously, the set value changes quickly. • If the set pressure range is exceeded, either UP (upper limit exceeded) or LD (lower limit exceeded) is displayed. 	<ul style="list-style-type: none"> • In the lower threshold value (M1) set mode, press MODE key. • If set value M1 is larger than the registered upper threshold value (M2), the sum of the M1 value plus 1 digit appears and blinks. Otherwise, the registered upper threshold value (M2) appears and blinks. The M2 setting indicator and the pressure unit indicator also blink. 	<ul style="list-style-type: none"> • Using ▲ key and ▼ key, enter in a manner similar to that for entering lower threshold value (M1). • If the set pressure range is exceeded, either UP (upper limit exceeded) or LD (lower limit exceeded) is displayed. 	<ul style="list-style-type: none"> • Press MODE key. • The sensor returns to sensing mode after lower threshold value (M1) and upper threshold value (M2) have been set.
			<ul style="list-style-type: none"> • When the window comparator mode has been selected during the initial setting, the lower threshold value (M1) and the upper threshold value (M2) should be set with a difference of 3 digits (0.03 kPa.D {3 mmH₂O.D}) or more. 	

Key-protect function

- Key-protect is a function which prevents any unintentional change in the conditions which have been entered in each setting mode by making the sensor not to respond to the key operations.

Setting of key-protect	Release of key-protect
<ul style="list-style-type: none"> • In the sensing mode, press MODE key continuously until 0n appears (4 sec. approx.). • Once 0n is displayed, release the key. Then the key-protect is set and the sensor enters into the sensing mode again. 	<ul style="list-style-type: none"> • In the sensing mode, press MODE key continuously until OFF appears (4 sec. approx.). • Once OFF is displayed, release the key. Then the key-protect is cancelled and the sensor enters into the sensing mode again.
<ul style="list-style-type: none"> • Since the key-protect information is stored in an EEPROM, it is not erased even if the power supply is switched off. • Please take care to remember if key-protect has been set. 	<ul style="list-style-type: none"> • When the keys are to be operated, make sure that key-protect is released.

Conversion of pressure units

- The conversion to different pressure units can be obtained by multiplying the values by the coefficients given in the table on the right.

Conversion procedure

- For example, if 2 kPa is to be expressed in kgf/cm², since 1 kPa = 1.01972 × 10⁻² kgf/cm², 2 kPa becomes 2 × 1.01972 × 10⁻² ≐ 0.020 kgf/cm².
- In the DP-M series, the pressure unit (kPa, mmH₂O) can be easily selected by key operation.

Conversion table for pressure units

	kPa	mmH ₂ O	mmHg (Torr)	kgf/cm ²	atm
1 kPa	1	1.01972 × 10 ²	7.50062	1.01972 × 10 ⁻²	9.86923 × 10 ⁻³
1 mmH ₂ O	9.80665 × 10 ⁻³	1	7.35559 × 10 ⁻²	1 × 10 ⁻⁴	9.67841 × 10 ⁻⁵
1mmHg (1Torr)	1.33322 × 10 ⁻¹	1.35951 × 10	1	1.35951 × 10 ⁻³	1.31579 × 10 ⁻³
1 kgf/cm ²	9.80665 × 10	1 × 10 ⁴	7.35559 × 10 ²	1	9.67841 × 10 ⁻¹
1 atm	1.01325 × 10 ²	1.03323 × 10 ⁴	7.60000 × 10 ²	1.03323	1

DP-M

DIMENSIONS (Unit: mm in) The CAD data in the dimensions can be downloaded from the SUNX website: <http://www.sunx.co.jp/>

**DP-M2
DP-M2A** Sensor

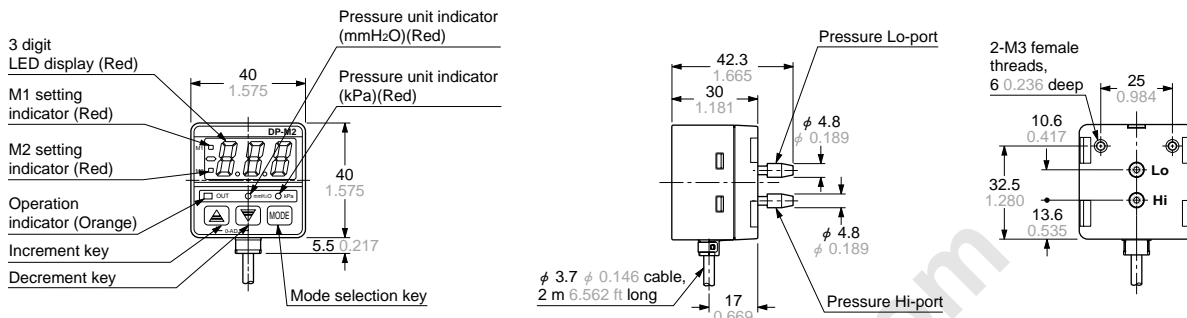

MS-PE-1 Sensor mounting bracket (Optional)

Assembly dimensions

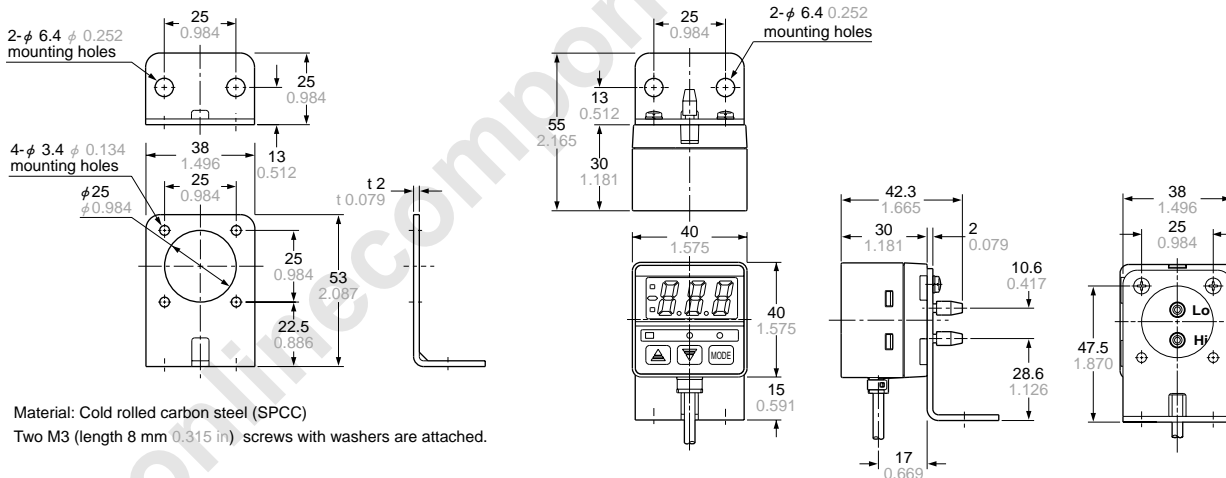

**MS-PE-2
MS-PE-3** Panel mounting bracket, front protection cover (Optional)

Assembly dimensions

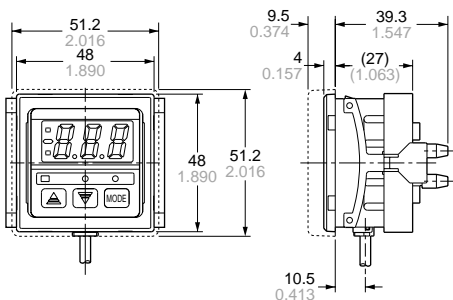

Panel cut-out dimensions

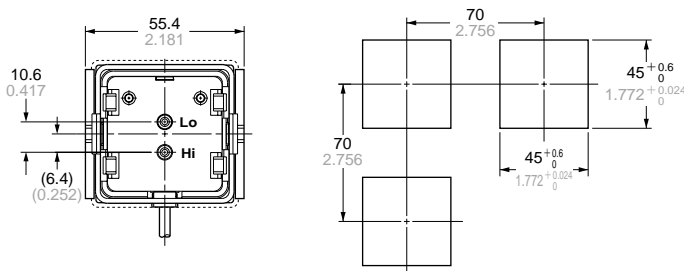

□ portion shows the front protection cover.
Material: Polycarbonate (Front protection cover)
Nylon 6, Polyacetal (Panel mounting bracket)

Note: The panel thickness should be 1 to 3.2 mm (0.039 to 0.126 in).