

# MS-Series Circuit Breaker

Carling Technologies' MS-Series Sealed Toggle Circuit Breaker was designed and tested to operate flawlessly in the harshest of environments.

Ideally suited for COTS (commercial off the shelf) military applications, the MS-Series features a durable metal and sealed mounting bushing with MIL-PRF-39019F ingress protection when mounted in a panel.

This class-leading, affordable circuit breaker was also designed in accordance with the requirements of MIL-PRF-55629 and MIL STD 202, making it the best choice when the application consideration includes shock, vibration, moisture resistance, salt spray and thermal shock.

The MS-Series' compact size and reliability make it ideal for ruggedized communication equipment and other mission critical equipment.

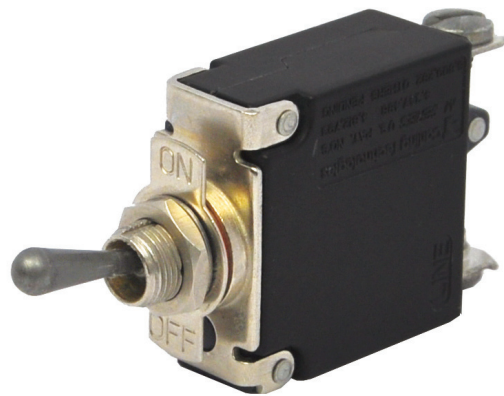

#### Features:

- ♦ Sealed toggle actuator
- ♦ MIL-PRF-39019F ingress protection
- ♦ MIL-PRF-55629 and MIL STD 202 compliant
- ♦ Compact design

#### COTS Military Applications:

- ♦ Vehicles
- ♦ Communication equipment
- ♦ Generators
- ♦ Power supplies



**Carling Technologies®**

Innovative Designs. Powerful Solutions.

Innovative Designs. Powerful Solutions.

Carling Technologies, Inc.  
60 Johnson Avenue • Plainville, CT 06062-1177  
Phone: (860) 793-9281 • Fax: (860) 793-9231  
Email: sales@carlingtech.com • www.carlingtech.com

## Electrical

Current Rating	.20 - 30 Amps
Voltage Rating	50VDC
Short Circuit Rating	See Table A
Dielectric Strength	UL,CSA 1500V, 50/60 Hz for one minute between all electrically isolated terminals
Insulation Resistance	Minimum of 100 Megohms @ 500VDC
Resistance	See reverse side
Time Delay	See reverse side

## Mechanical

Endurance	10,000 On-Off operations @ 6 per minute with rated current and voltage
Trip Free	Trips on short circuit and overload, even when the actuator is forcibly held in the "On" position
Trip Indication	The operating handle moves positively to the "Off" position when a short circuit or overload causes the circuit breaker to trip.

## Agency Certifications

UL Standard 1077



CUL Standard C22.2

## Electrical Tables

**Table A:** Lists UL & CSA Configuration & Performance Capabilities

MS-SERIES TABLE A: COMPONENT SUPPLEMENTARY PROTECTORS										
CIRCUIT CONFIGURATION	VOLTAGE			CURRENT RATING		POLES BREAKING	SHORT CIRCUIT CAPACITY (AMPS)		APPLICATION CODES	
	MAX. RATING	FREQ	PHASE	FULL LOAD AMPS	GENERAL PURPOSE AMPS		UL/CSA		UL	CSA
							WITH BACKUP FUSE	WITHOUT BACKUP FUSE		
	50	DC	---	---	0.02 - 30	1	---	3000	TC1,2,OL0,U3	TC1,2,OL0,U3
	50	DC	---	---	0.02 - 30	1	---	8000	TC1,2,OL0,U1	TC1,2,OL0,U1

\*Manufacturer reserves the right to change product specification without prior notice.

## Physical

Number of Poles	1 pole
Weight	Approximately 1.8 oz (50 G) per pole
Dimensions	See reverse side

## Environmental

Designed in accordance with requirements of specification MIL-PRF-55629 & MIL-STD-202G as follows:

Shock	Withstands 100G's, 6ms, saw tooth while carrying rated current per Method 213, Condition I. Instantaneous curves tested at 80% of rated current.
Vibration	Withstands 0.060" excursion from 10-55 Hz, and 10G's 55-500 Hz, at rated current per Method 204C, Test Condition A. Instantaneous curves tested at 80% of rated current.
Salt Spray	Method 101, Condition A (90-95% RH @ 5% NaCl Solution, 96 hrs)
Moisture Resistance	Moisture Resistance Method 106G
Thermal Shock	Method 107D, Condition A (Five cycles @ -55°C to +25°C to +85°C to +25°C)
Operating Temperature	-40°C to +85°C
Ingress Protection Level	MIL-PRF-55629C when mounted in panel.
Other	Materials used in this product shall be non-nutrient to fungus growth

## Delay Curve

Dual Rated AC/DC

### Instantaneous

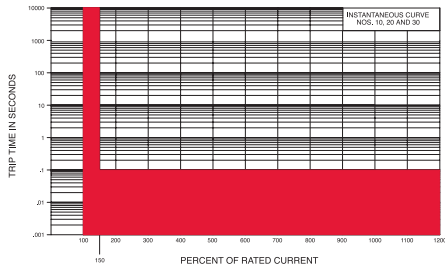

### Short

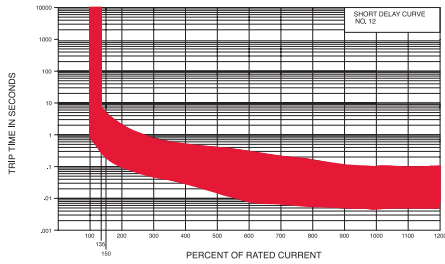

### Medium

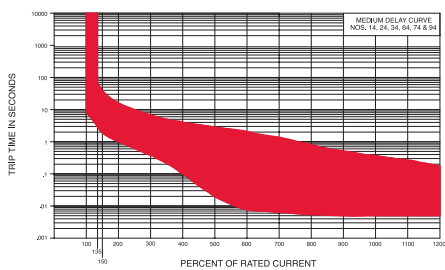

## Form & Fit

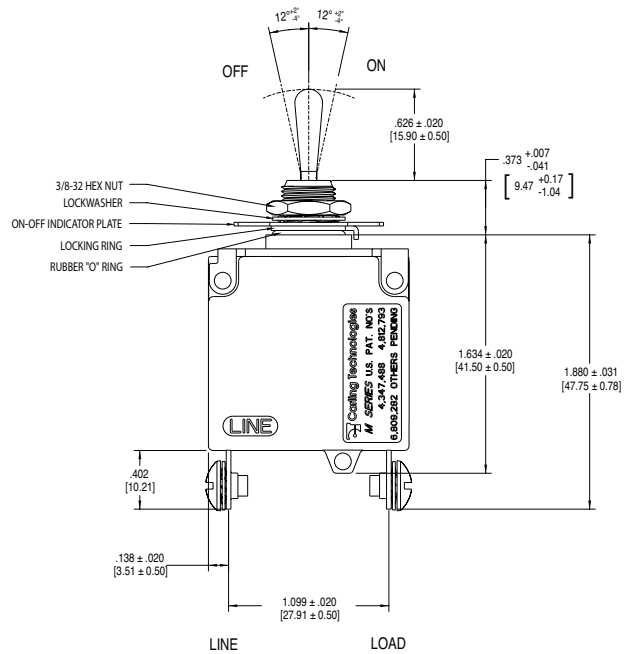
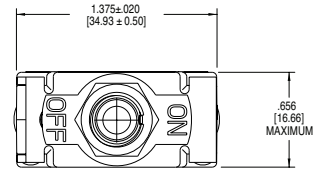

## Resistance, Impedance Values

RESISTANCE, IMPEDANCE VALUES  
from Line to Load Terminals  
(Values Based on Series Trip Circuit Breaker)

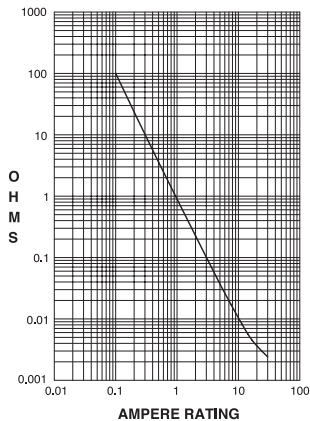

CURRENT (AMPS)	TOLERANCE (%)
0.20 - 30.0	25%

