

30° ANGLE OF THROW

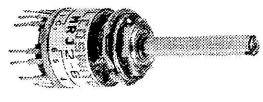

MRJ26

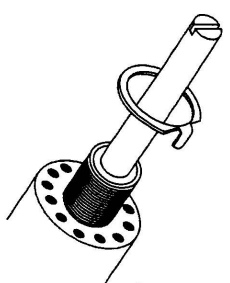
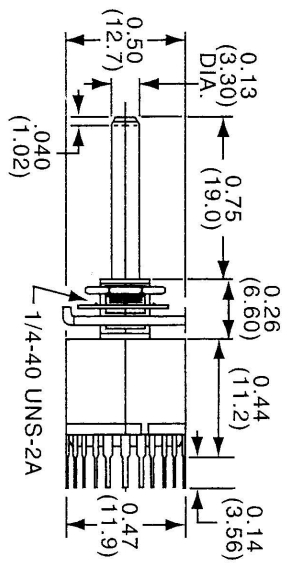

MRJ43

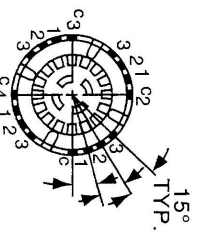

MRJ34

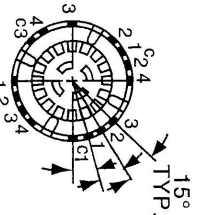

MRJ26

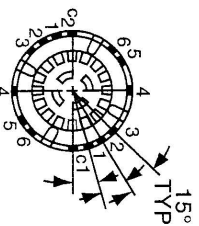

MRJ112

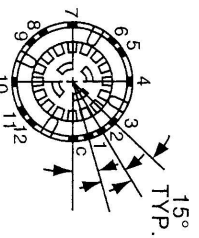

Model	No. Poles	Positions	Description
*MRJ112	1 Pole	2 to 12, Adjustable	
MRJ26	2 Poles	2 to 6, Adjustable	3/4" long, 1/8: Diameter shaft.
MRJ34	3 Poles	2 to 4, Adjustable	
MRJ43	4 Poles	2 to 3, Adjustable	

* Also usable as continuous rotation.

Application Note: Set stop positions by presetting external pin plate provided.

SPLASHPROOF 30° ANGLE OF THROW

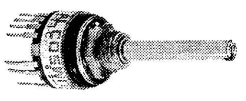

MRJE26

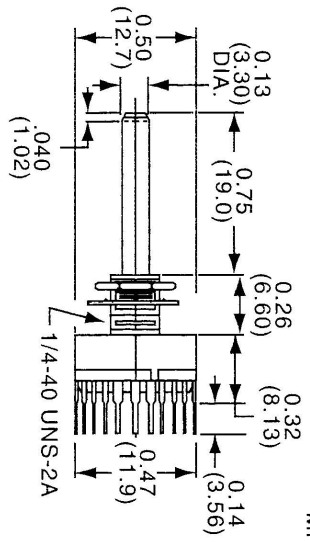

MRJE43

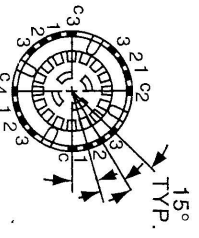

MRJE34

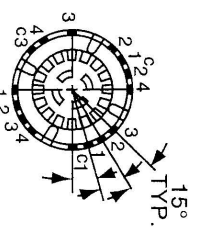

MRJE26

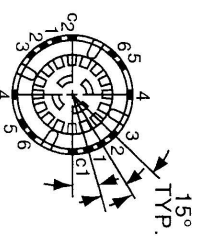

MRJE112

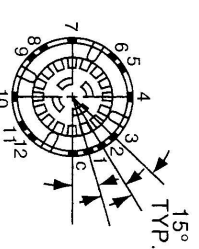

Model	No. Poles	Positions	Description
MRJE112	1 Pole	12 Continuous Rotation	
MRJE26	2 Poles	6 Fixed	Waterproof Seal on Shaft, Bushing & Base
MRJE34	3 Poles	4 Fixed	
MRJE43	4 Poles	3 Fixed	