

Phase Control Thyristor

multicomp PRO

RoHS
Compliant

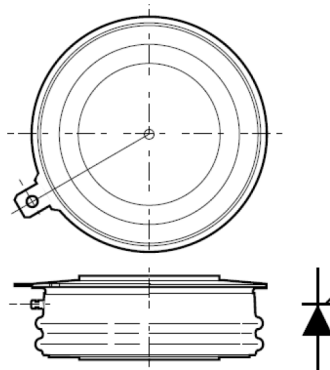

Outline type code: D

Features

- Double Side Cooling
- High Surge Capability

Applications

- High Power Drives
- High Voltage Power Supplies
- Static Switches

Key Parameters

Part Number	Repetitive Peak Voltages V_{DRM} and V_{RRM} V	$I_{T(AV)}$	I_{TSM}	dV/dt^*	dI/dt	Conditions
MPPCT750D220 MPPCT750D240	2200 2400	750 A	10000 A	1000 V/ μ s	200 A/ μ s	$T_{vj} = -40^{\circ}\text{C}$ to 125°C , $I_{DRM} = I_{RRM} = 50\text{mA}$, $V_{DRM}, V_{RRM} t_p = 10\text{ms}$, $V_{DSM} \& V_{RSM} =$ $V_{DRM} \& V_{RRM} + 100\text{V}$ respectively

* Higher dV/dt selections available

Current Ratings

$T_{case} = 60^{\circ}\text{C}$ unless stated otherwise

Symbol	Parameter	Test Conditions	Max.	Units
$I_{T(AV)}$	Mean on-state current	Half wave resistive load	750	A
$I_{T(RMS)}$	RMS value	-	1180	
I_T	Continuous (direct) on-state current	-	1060	

Surge Ratings

Symbol	Parameter	Test Conditions	Max.	Units
I_{TSM}	Surge (non-repetitive) on-state current	10ms half sine, $T_{case} = 125^{\circ}\text{C}$ $V_R = 0$	10	kA
I^2t	I^2t for fusing		0.5	MA^2s

Newark.com/multicomp-pro
Farnell.com/multicomp-pro
Element14.com/multicomp-pro

multicomp PRO

Thermal and Mechanical Ratings

Symbol	Parameter	Test Conditions	Min.	Max.	Units
R _{th(j-c)}	Thermal resistance – junction to case	Double side cooled DC	-	0.035	°C/W
R _{th(c-h)}	Thermal resistance – case to heatsink			0.01	
T _{vj}	Virtual junction temperature	Blocking V _{DRM} / V _{RRM}		125	°C
T _{stg}	Storage temperature range		-40	140	
F _m	Clamping force		8	12	kN

Dynamic Characteristics

Symbol	Parameter	Test Conditions	Min.	Max.	Units
I _{RRM} /I _{DRM}	Peak reverse and off-state current	At V _{RRM} /V _{DRM} , T _{case} = 125°C	-	50	mA
dV/dt	Max. linear rate of rise of off-state voltage	To 67% V _{DRM} , T _j = 125°C, gate open	1000	-	V/μs
di/dt	Rate of rise of on-state current	From 67% V _{DRM} to 1000A Gate source 30V, 10Ω, t _r < 0.5μs, T _j = 125°C	Repetitive 50Hz	200	A/μs
			Non-repetitive	1000	
V _T	On-state voltage	I _T = 1500A, T _{case} = 125°C		2	V
V _{T(TO)}	Threshold voltage – Low level	T _{case} = 125°C		0.92	
r _T	On-state slope resistance – Low level	T _{case} = 125°C		0.72	mΩ
t _{gd}	Delay time	V _D = 67% V _{DRM} , gate source 30V, 10Ω t _r = 0.5μs, T _j = 25°C		3	μs
t _q	Turn-off time	T _j = 125°C, V _R = 100V, di/dt = 10A/μs, dV _{DR} /dt = 20V/μs linear to 67% V _{DRM}		150	
Q _s	Stored charge	I _T = 1000A, t _p = 1000us, T _j = 125°C, di/dt = 10A/μs,		2300	μC
I _{RR}	Reverse recovery current			125	A
I _L	Latching current	T _j = 25°C,		1	
I _H	Holding current	T _j = 25°C,		200	mA

Gate Trigger Characteristics and Ratings

Symbol	Parameter	Test Conditions	Max.	Units
V _{GT}	Gate trigger voltage	V _{DRM} = 5V, T _{case} = 25°C	3	V
V _{GD}	Gate non-trigger voltage	At 40% V _{DRM} , T _{case} = 125°C	0.3	
I _{GT}	Gate trigger current	V _{DRM} = 5V, T _{case} = 25°C	300	mA
I _{GD}	Gate non-trigger current	At 40% V _{DRM} , T _{case} = 125°C	20	

Performance Curves

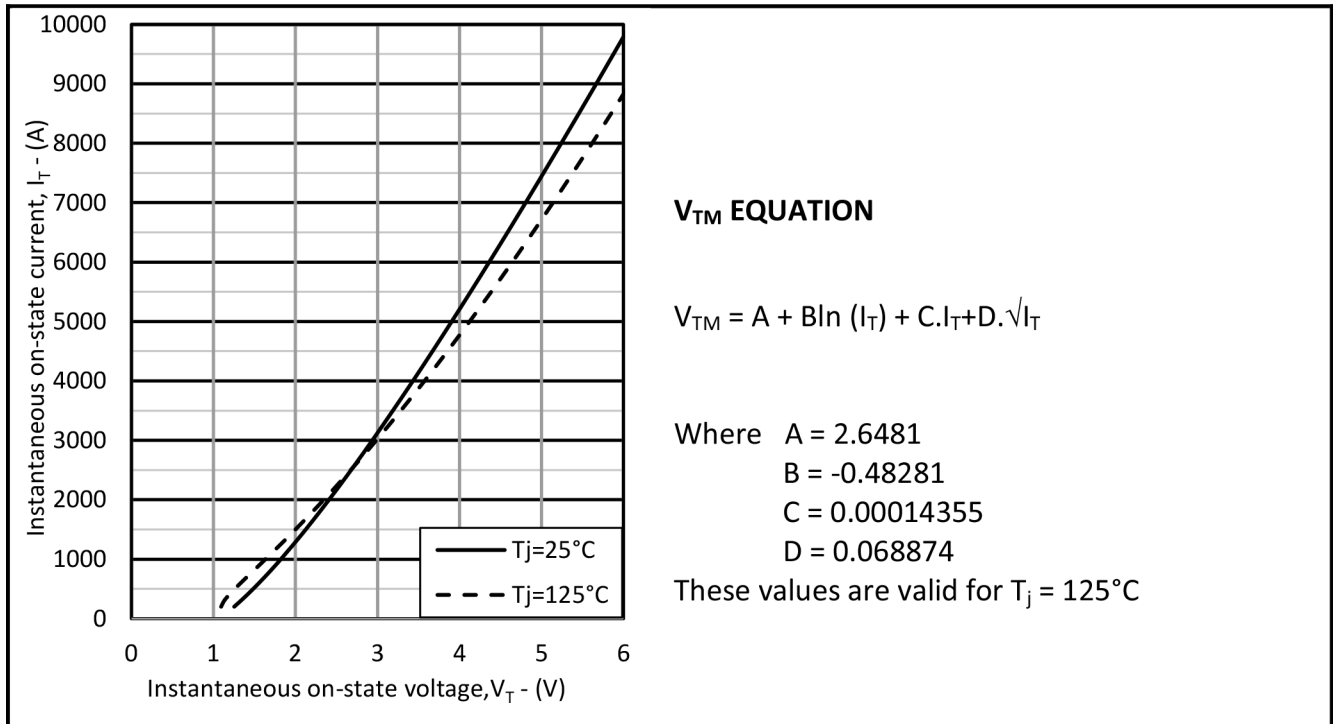

Fig.2 Maximum & minimum on-state characteristics

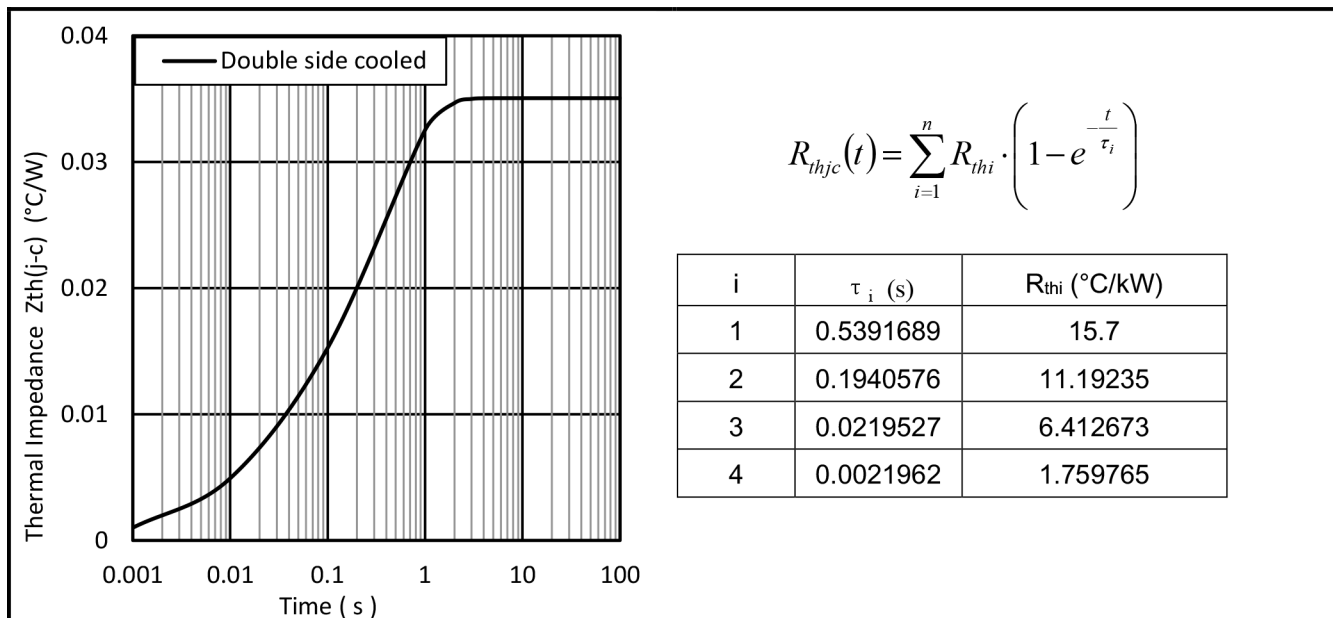

Fig.3 Maximum (limit) transient thermal impedance – junction to case (°C/W)

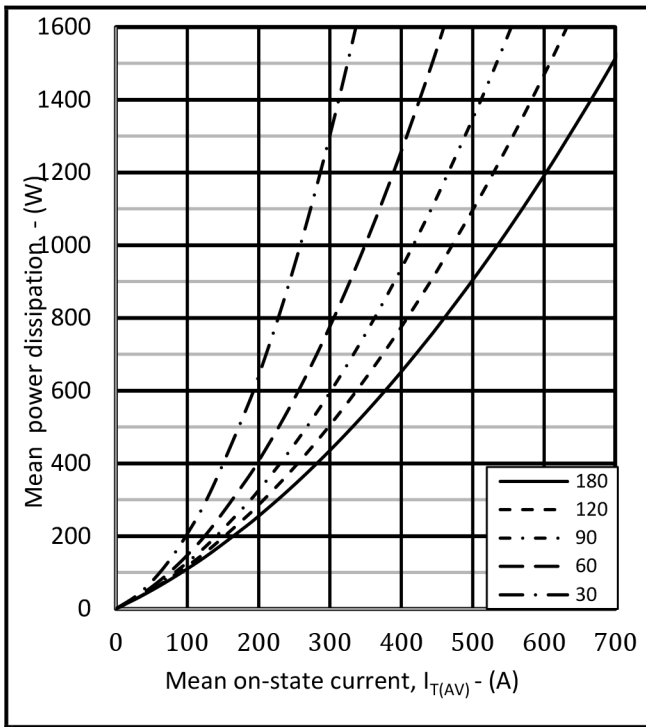

Fig.4 On-state power dissipation – sine wave

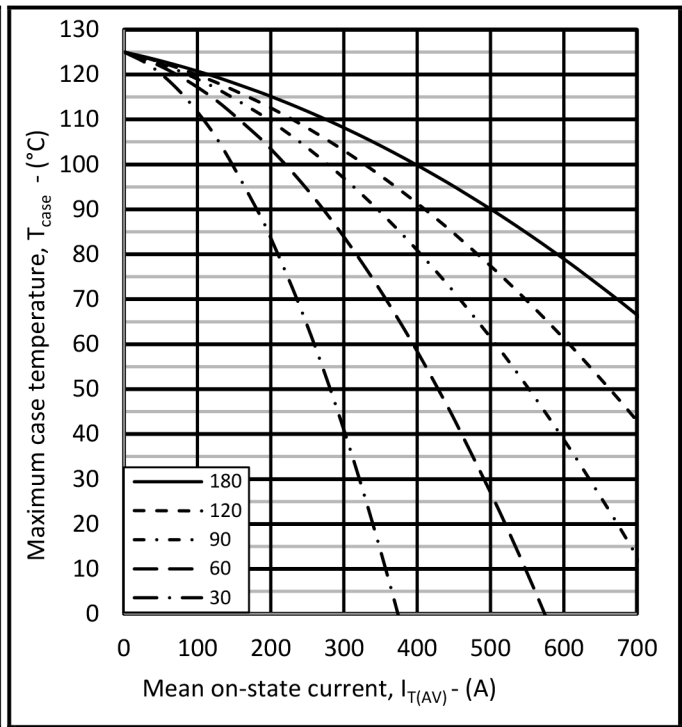

Fig.5 Maximum permissible case temperature, double side cooled – sine wave

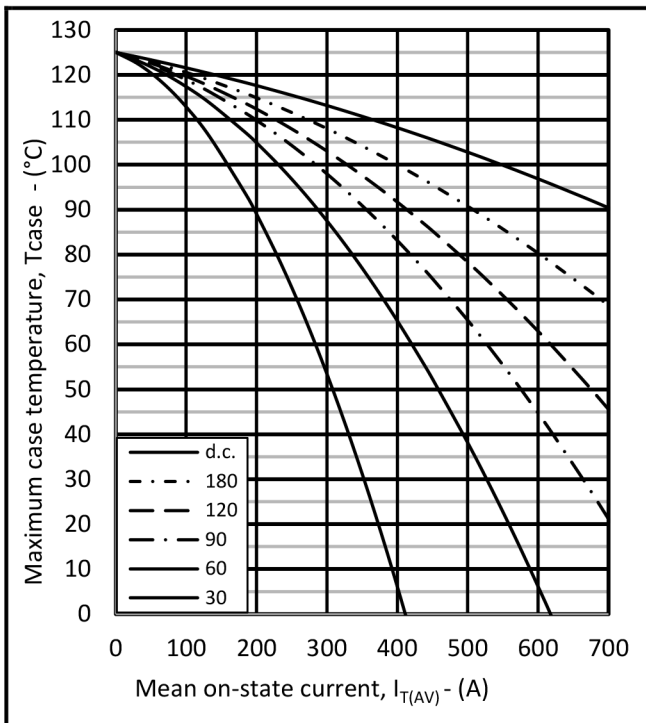

Fig.6 Maximum permissible case temperature, double side cooled – rectangular wave

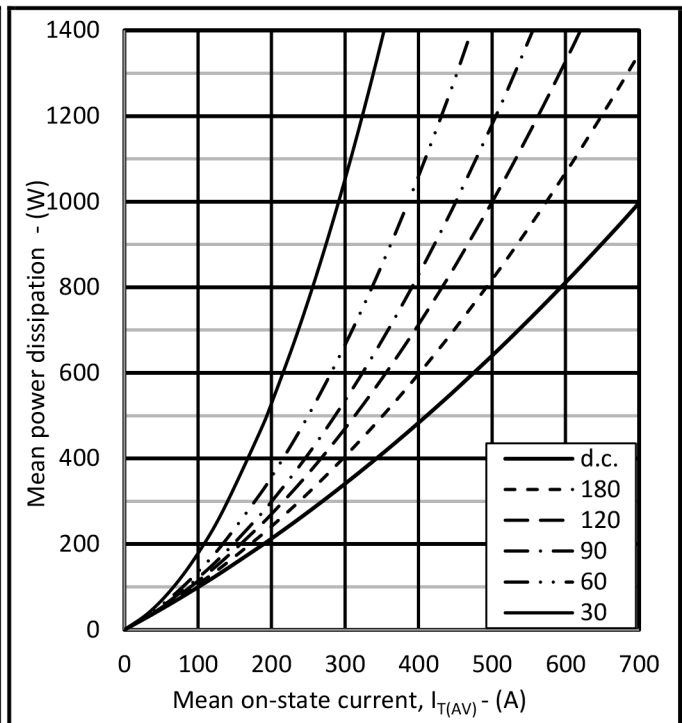

Fig.7 On-state power dissipation – rectangular wave

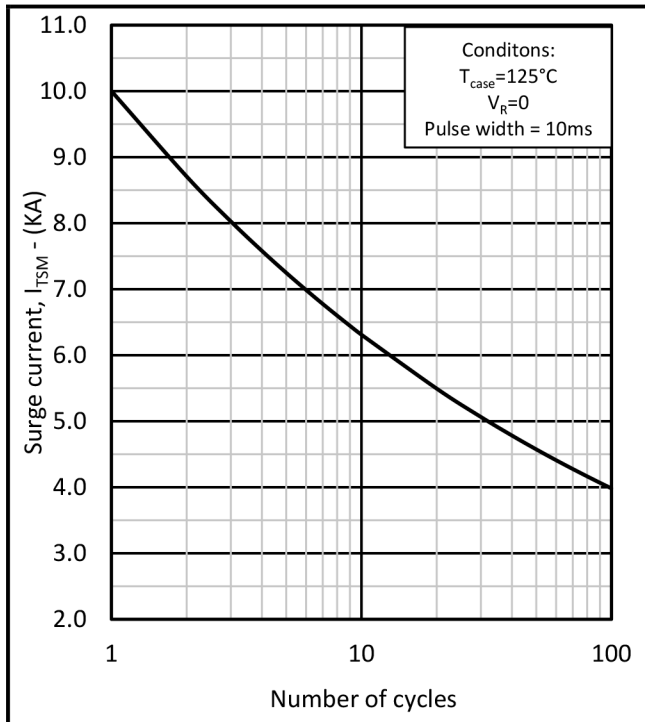

Fig.8 Multi-cycle surge current

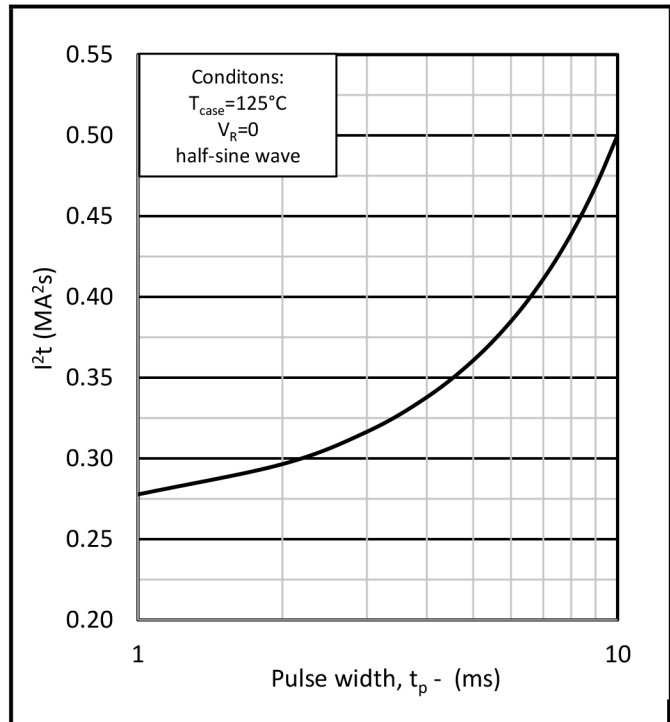

Fig.9 Single-cycle I^2t

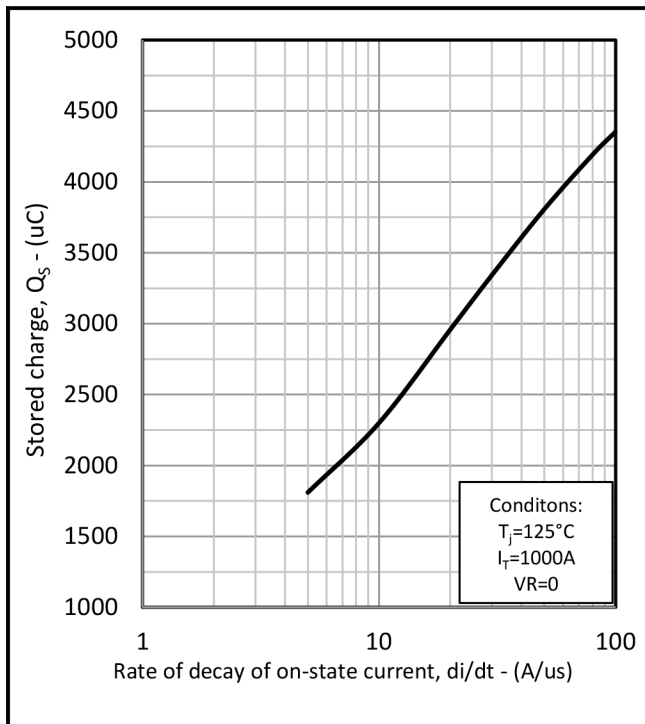

Fig.10 Stored charge vs di/dt

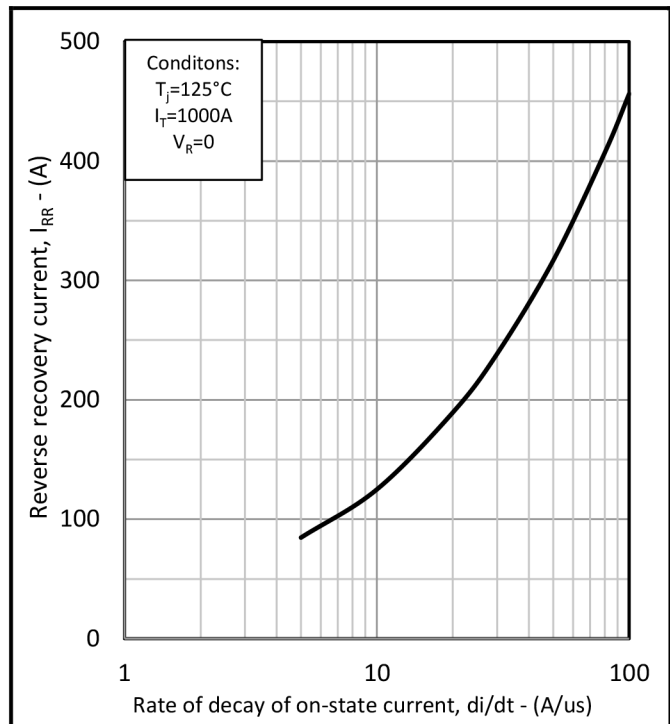

Fig.11 Reverse recovery current vs di/dt

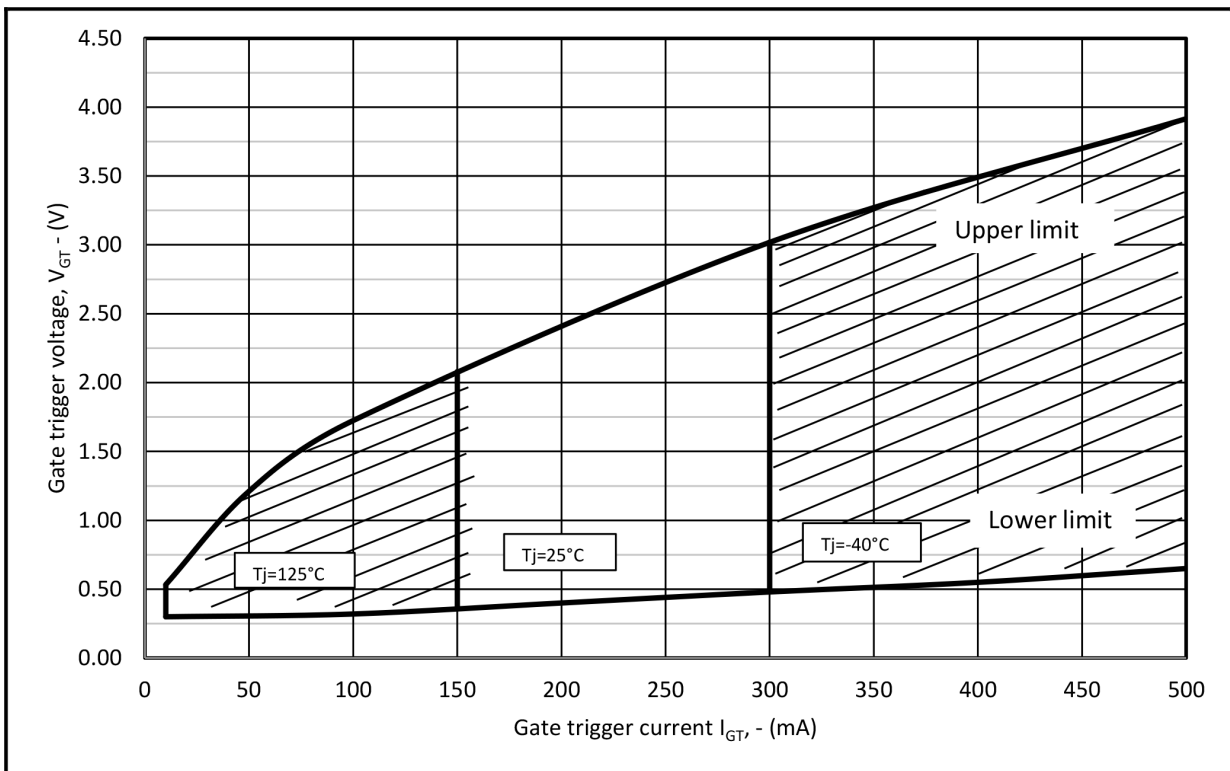
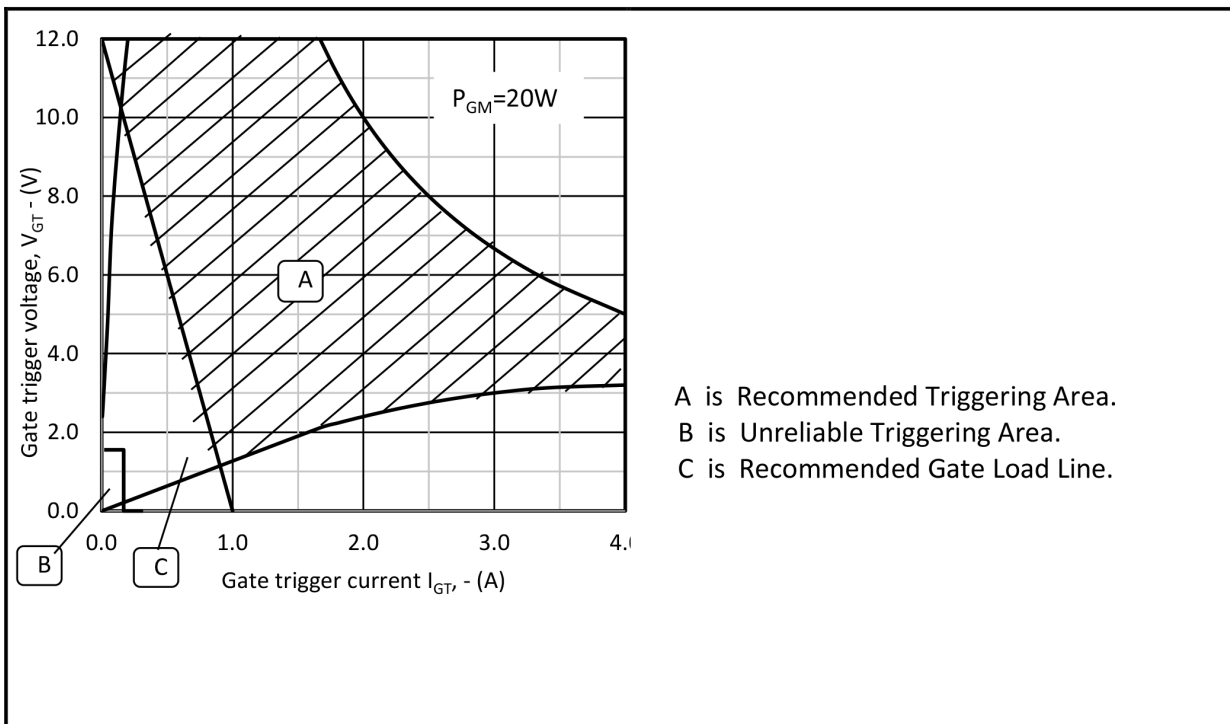

Fig.12 Gate characteristics



A is Recommended Triggering Area.
 B is Unreliable Triggering Area.
 C is Recommended Gate Load Line.

Fig.13 Gate characteristics

Phase Control Thyristor

multicomp PRO

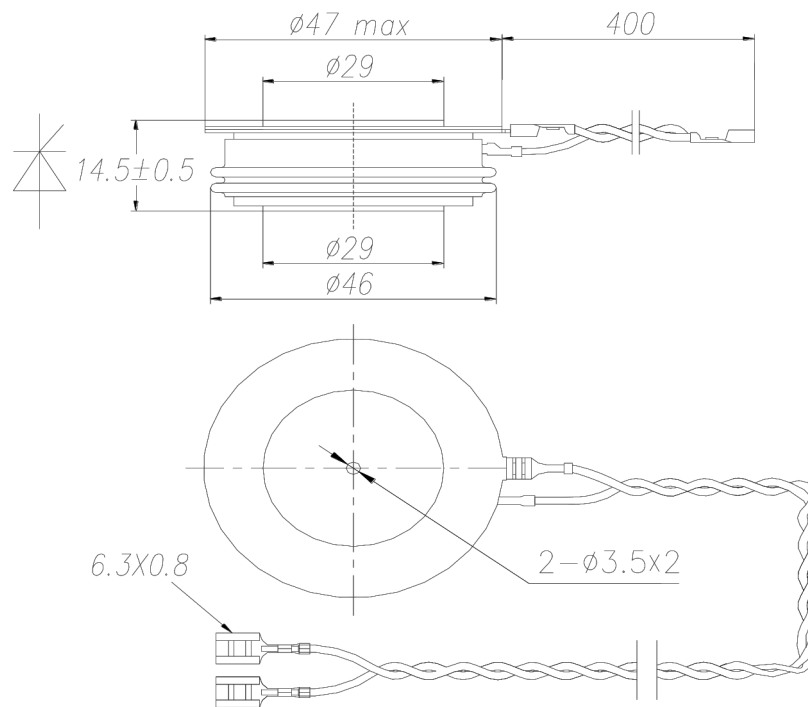

Package outline type code: D

Part Number Table

Description	Part Number
Phase Control Thyristor Module, 2200V, 750A, D Case Code	MPPCT750D220
Phase Control Thyristor Module, 2400V, 750A, D Case Code	MPPCT750D240

Important Notice : This data sheet and its contents (the "Information") belong to the members of the AVNET group of companies (the "Group") or are licensed to it. No licence is granted for the use of it other than for information purposes in connection with the products to which it relates. No licence of any intellectual property rights is granted. The Information is subject to change without notice and replaces all data sheets previously supplied. The Information supplied is believed to be accurate but the Group assumes no responsibility for its accuracy or completeness, any error in or omission from it or for any use made of it. Users of this data sheet should check for themselves the Information and the suitability of the products for their purpose and not make any assumptions based on information included or omitted. Liability for loss or damage resulting from any reliance on the Information or use of it (including liability resulting from negligence or where the Group was aware of the possibility of such loss or damage arising) is excluded. This will not operate to limit or restrict the Group's liability for death or personal injury resulting from its negligence. Multicomp Pro is the registered trademark of Premier Farnell Limited 2019.

Newark.com/multicomp-pro
 Farnell.com/multicomp-pro
 Element14.com/multicomp-pro

multicomp PRO