

# 1W Isolated DC to DC Converters - Single Output **multicomp**PRO

1W isolated DC-DC converter Fixed input voltage, unregulated single output



## Features

- Continuous short-circuit protection
- No-load input current as low as 8mA
- Operating ambient temperature range: -40°C to +105°C
- High efficiency up to 85%
- Compact SMD package
- I/O isolation test voltage: 3k VDC
- Industry standard pin-out

**RoHS  
Compliant**

These series are specially designed for applications where an isolated voltage is required in a distributed power supply system. They are suitable for: pure digital circuits, low frequency analog circuits, relay-driven circuits and data switching circuits.

## Selection Guide

Part Number	Input Voltage (VDC)	Output		Full Load Efficiency (%) Min./Typ.	Capacitive Load(μF)* Max.
	Nominal (Range)	Voltage (VDC)	Current (mA) Max./Min.		
MPF1205XT-1W	12 (10.8 to 13.2)	5	200/20	78/82	2400
MPF1209XT-1W		9	111/12		
MPF1212XT-1W		12	84/9	79/83	1000
MPF1215XT-1W		15	67/7		
MPF1224XT-1W		24	42/4		
MPF1505XT-1W	15 (13.5 to 16.5)	5	200/20	78/82	2400
MPF1515XT-1W		15	67/7	79/83	560
MPF2405XT-1W	24 (21.6 to 26.4)	5	200/20	76/82	2400
MPF2409XT-1W		9	111/12		
MPF2412XT-1W		12	84/9	77/83	1000
MPF2415XT-1W		15	67/7		
MPF2424XT-1W		24	42/4		
				79/85	220

## Input Specifications

Item	Operating Conditions		Min.	Typ.	Max.	Unit
Input Current (full load / no-load)	12V input	5VDC output	-	102/8	107/--	mA
		9VDC/12VDC/15VDC output	-	101/8	106/--	
		24VDC output	-	99/8	103/--	
	15VDC input	5VDC output	-	82/8	86/--	
		15VDC output	-	81/8	85/--	
	24V input	5VDC/9VDC/12VDC/15VDC output	-	51/8	55/--	
24VDC output		-	50/8	53/--		
Reflected Ripple Current*			-	30	-	
Surge Voltage(1sec. max.)	12VDC input		-0.7	-	18	V DC
	15VDC input				21	
	24VDC input				30	
Input Filter			Capacitance filter			
Hot Plug			Unavailable			

Note: \* Reflected ripple current testing method please see DC-DC Converter Application Notes for specific operation.

Newark.com/multicomp-pro  
Farnell.com/multicomp-pro  
Element14.com/multicomp-pro

**multicomp**PRO

# 1W Isolated DC to DC Converters - Single Output **multicomp** PRO

## Output Specifications

Item	Operating Conditions	Min.	Typ.	Max.	Unit	
Voltage Accuracy		See output regulation curves (Fig. 1)				
Linear Regulation	Input voltage change: $\pm 1\%$		-	1.2	-	
Load Regulation	10% -100% load	-	$\pm 5\text{VDC}$ output	10	15	%
			$\pm 9\text{VDC}$ output	8	10	
			$\pm 12\text{VDC}$ output	7	10	
			$\pm 15\text{VDC}$ output	6	10	
			$\pm 24\text{VDC}$ output	5	10	
Ripple & Noise*	20MHz bandwidth	-	$\pm 5\text{VDC}/\pm 9\text{VDC}/\pm 12\text{VDC}/\pm 15\text{VDC}$ output	30	75	mVp-p
			$\pm 24\text{VDC}$ output	50	100	
Temperature Coefficient	100% load		$\pm 0.02$	-	%/°C	
Short-Circuit Protection		Continuous, self-recovery				
Note: * The "parallel cable" method is used for ripple and noise test, please refer to DC-DC Converter Application Notes for specific information.						

## General Specifications

Item	Operating Conditions	Min.	Typ.	Max.	Unit
Isolation	Input-output electric strength test for 1 minute with a leakage current of 1mA max.	3000	-	-	VDC
Insulation Resistance	Input-output resistance at 500VDC	1000	-	-	MΩ
Isolation Capacitance	Input-output capacitance at 100kHz/0.1V	-	20	-	pF
Operating Temperature	Derating when operating temperature $\geq 100^\circ\text{C}$ , (see Fig. 2)	-40	-	105	°C
Storage Temperature		-55	-	125	
Case Temperature Rise	Ta=25°C	-	25	-	
Storage Humidity	Non-condensing	5	-	300	
Reflow Soldering Temperature*		Peak temp. $\leq 245^\circ\text{C}$ , maximum duration time $\leq 60\text{s}$ over $217^\circ\text{C}$			
Switching Frequency	Full load, nominal input voltage	-	260	-	kHz
MTBF	MIL-HDBK-217F@25°C	3500	-	-	k hours
Moisture Sensitivity Level (MSL)	IPC/JEDEC J-STD-020D.1	Level 1			

## Mechanical Specifications

Case Material	Black plastic; flame-retardant and heat-resistant (UL94 V-0)
Dimensions	13.2 x 11.4 x 7.25 mm
Weight	1.4g(Typ.)
Cooling Method	Free air convection

# 1W Isolated DC to DC Converters - Single Output **multicomp** PRO

## Electromagnetic Compatibility (EMC)

Emissions	CE	CISPR32/EN55032 CLASS B(see Fig. 4 for recommended circuit)
	RE	CISPR32/EN55032 CLASS B(see Fig. 4 for recommended circuit)
Immunity	ESD	IEC/EN61000-4-2 Contact $\pm 6\text{kV}$ perf. Criteria B

## Typical Performance Curves

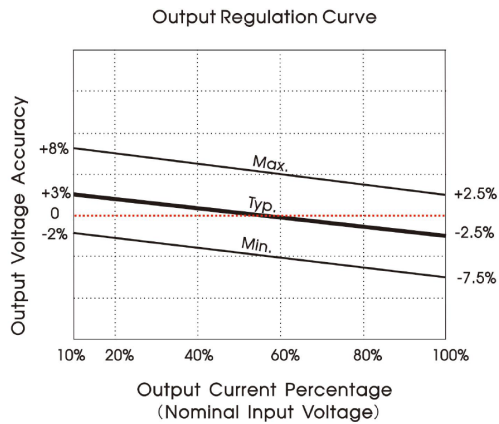

Fig. 1

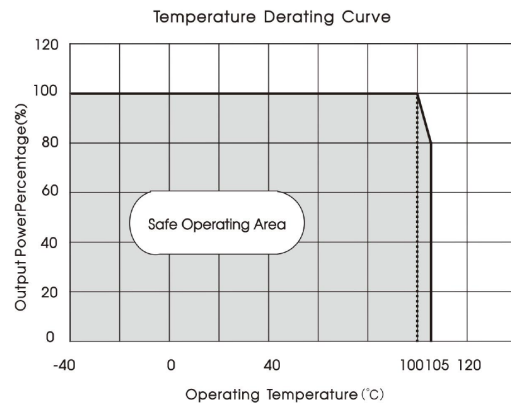
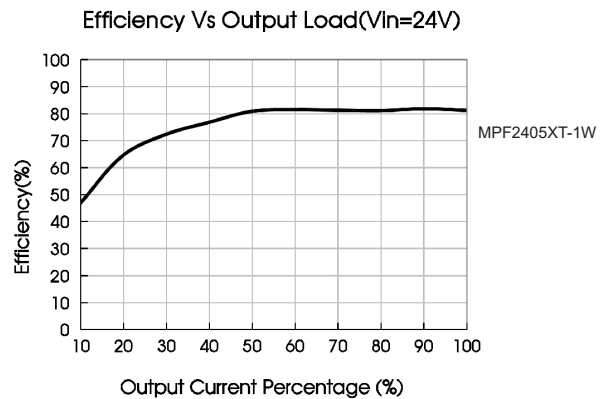
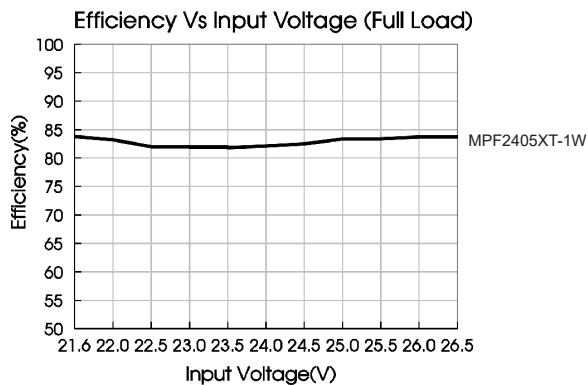
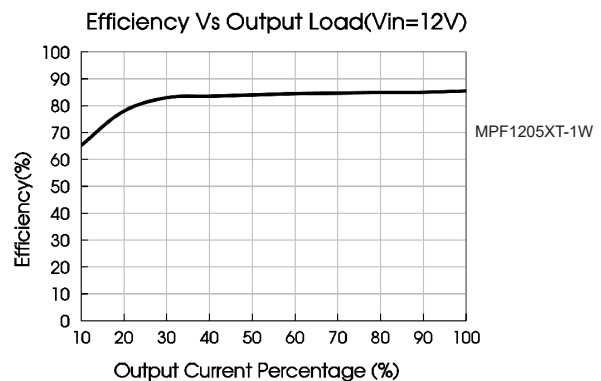
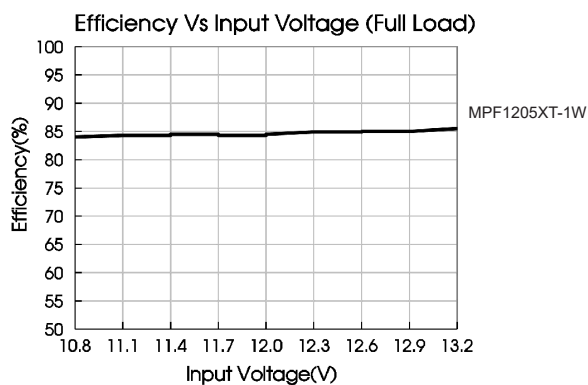

Fig. 2



# 1W Isolated DC to DC Converters - Single Output

**multicomp** PRO

## Design Reference

### Typical application

Input and/or output ripple can be further reduced, by connecting a filter capacitor from the input and/or output terminals to ground as shown in Fig.3.

Choosing suitable filter capacitor values is very important for a smooth operation of the modules, particularly to avoid start-up problems caused by capacitor values that are too high. For recommended input and output capacitor values refer to Table 1.



Fig.3

Table 1: Recommended input and output capacitor values

Vin	Cin	Vo	Cout
12VDC	2.2µF/25V	5VDC	10µF/16V
15VDC	2.2µF/25V	9VDC	2.2µF/16V
24VDC	1µF/50V	12VDC	2.2µF/25V
-	-	15VDC	1µF/25V
-	-	24VDC	1µF/50V

### 2. EMC (CLASS B) compliance circuit

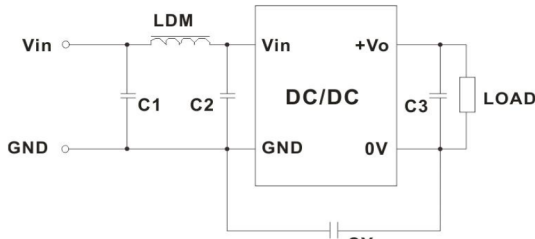

Fig.4

Table 2: EMC recommended circuit value table

Emissions	C1	4.7µF /50V
	C2	4.7µF /50V
	CY	270pF/3kV
	C3	Refer to the Cout in table 1
	LDM	6.8µH

### Minimum Output Load Requirement

For a reliable and efficient operation of the converter, the minimum load should never be less than 1% of the rated output load. If the total required output power is below 1%, a parallel bleeding resistor is required on the output, ensuring that the sum of the power consumption is always maintained at 1% minimum.

### Dimensions and Recommended Layout

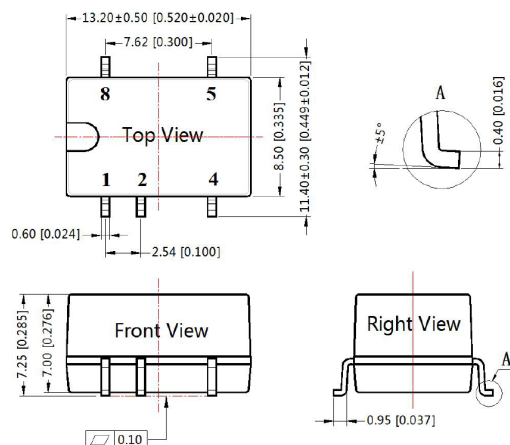

Note:  
Unit: mm[inch]  
Pin section tolerances: ±0.10[±0.004]  
General tolerances: ±0.25[±0.010]

THIRD ANGLE PROJECTION

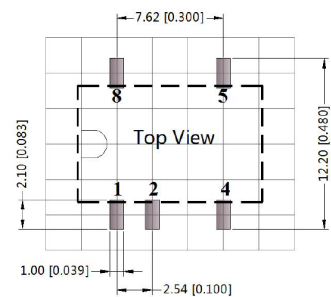

Note: Grid 2.54\*2.54mm

Pin-Out	
Pin	Function
1	GND
2	Vin
4	0V
5	+Vo
8	NC

NC: Pin to be isolated from circuitry

# 1W Isolated DC to DC Converters - Single Output **multicomp** PRO

## Tape and Reel Info

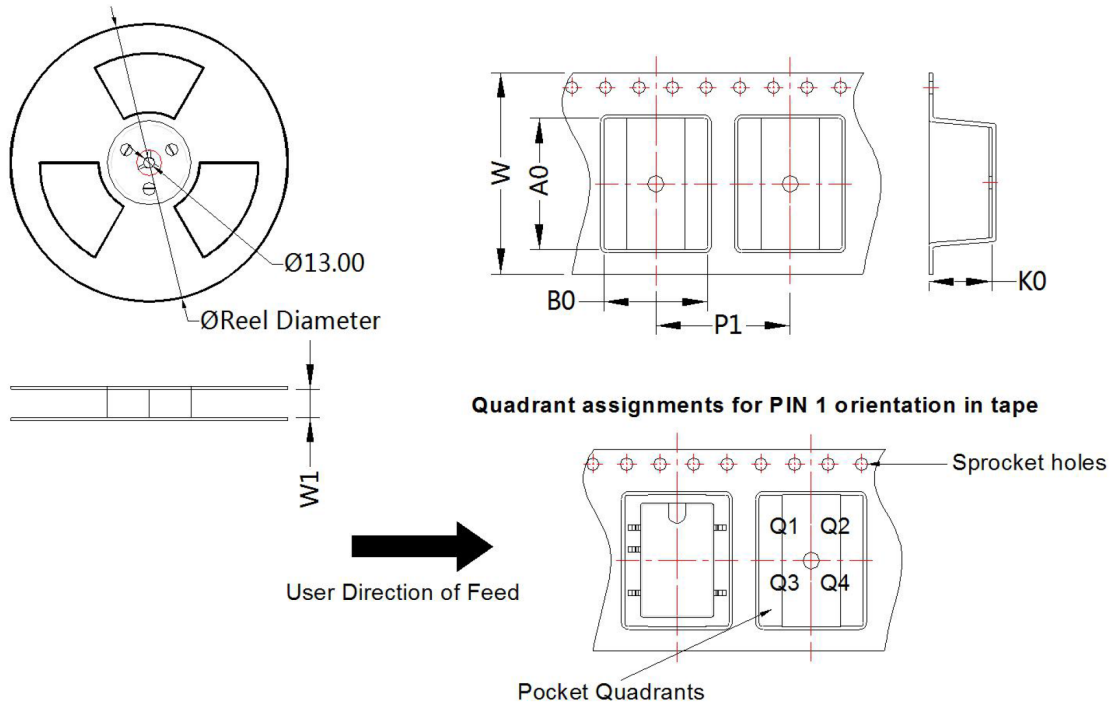

Package Type	Pin	SPQ	Reel Diameter (mm)	Reel Width W1 (mm)	A0 (mm)	B0 (mm)	K0 (mm)	P1 (mm)	W (mm)	Pin1 Quadrant
SMD	5	500	330.0	24.5	13.4	11.7	7.5	16.0	24.0	Q1

### Notes:

1. If the product is not operated within the required load range, the product performance cannot be guaranteed to comply with all parameters in the datasheet;
2. The maximum capacitive load offered were tested at input voltage range and full load;
3. Unless otherwise specified, parameters in this datasheet were measured under the conditions of  $T_a=25^{\circ}\text{C}$  , humidity<75%RH with nominal input voltage and rated output load;
4. All index testing methods in this datasheet are based on our company corporate standards;
5. We can provide product customization service, please contact our technicians directly for specific information;
6. Products are related to laws and regulations: see "Features" and "EMC";
7. Our products shall be classified according to ISO14001 and related environmental laws and regulations, and shall be handled by qualified units.

**Important Notice :** This data sheet and its contents (the "Information") belong to the members of the AVNET group of companies (the "Group") or are licensed to it. No licence is granted for the use of it other than for information purposes in connection with the products to which it relates. No licence of any intellectual property rights is granted. The Information is subject to change without notice and replaces all data sheets previously supplied. The Information supplied is believed to be accurate but the Group assumes no responsibility for its accuracy or completeness, any error in or omission from it or for any use made of it. Users of this data sheet should check for themselves the Information and the suitability of the products for their purpose and not make any assumptions based on information included or omitted. Liability for loss or damage resulting from any reliance on the Information or use of it (including liability resulting from negligence or where the Group was aware of the possibility of such loss or damage arising) is excluded. This will not operate to limit or restrict the Group's liability for death or personal injury resulting from its negligence. Multicomp Pro is the registered trademark of Premier Farnell Limited 2019.

Newark.com/multicomp-pro  
 Farnell.com/multicomp-pro  
 Element14.com/multicomp-pro

**multicomp** PRO