

Test Leads Kit, 22 Piece **multicomp**PRO

**RoHS
Compliant**



Kit Contents

5 Pcs Test Leads, 2 Pcs Crocodile Clips, 4 Pcs of Banana Adapters, 11 Pcs of Probe Tips and Wrench

Diagram

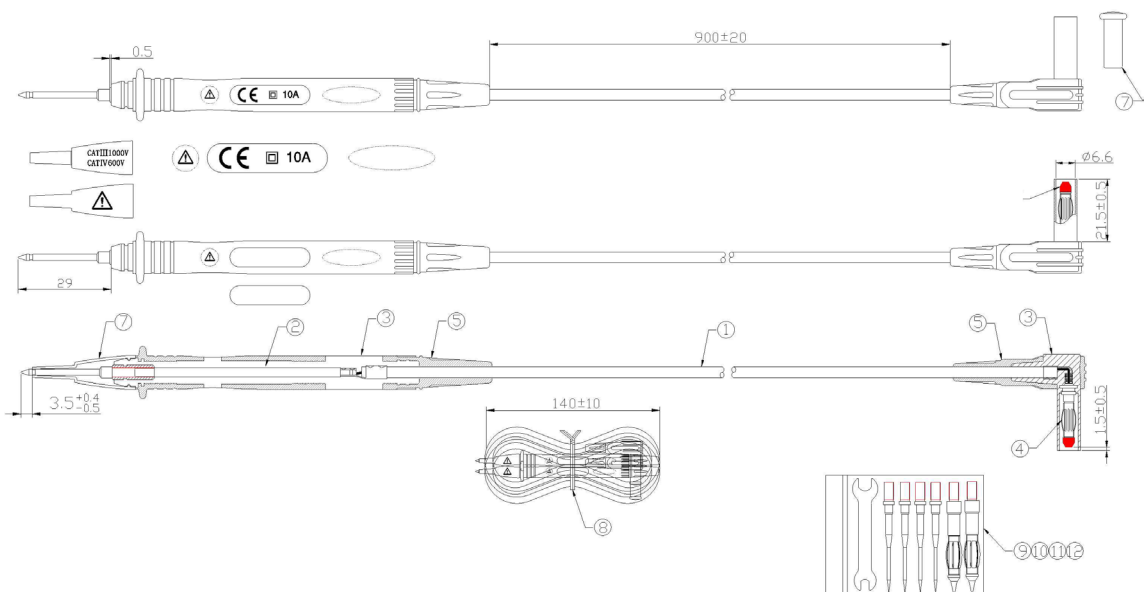

| No. | Description |
|-----|---|
| 1 | UL 1803 18AWG (102/0.1BC) + 250D : OD:3.6mm PVC |
| 2 | ∅4.5 × 13.5mm + ∅3 × 69.5 H65 |
| 3 | 20P PVC (94V-1) (Pantone:1797C) / : 3C2X |
| 4 | ∅5 × 25.2mm + ∅3 × 12mm + H65 |
| 5 | 70P PVC (94V-1) |
| 6 | TL88-1 / PP |
| 7 | ∅4.8 (Pantone:1797C) / :3C2X PE |
| 8 | L = 120mm |
| 9 | ∅4.5 × .4.5mm + ∅3 × 12 |
| 10 | ∅3.5 × .34.5 |
| 11 | SUS304 |
| 12 | 110 × 70 × 0.04mm PE |

Newark.com/multicomp-pro
Farnell.com/multicomp-pro
Element14.com/multicomp-pro

multicompPRO

Test Leads Kit, 22 Piece

multicomp PRO

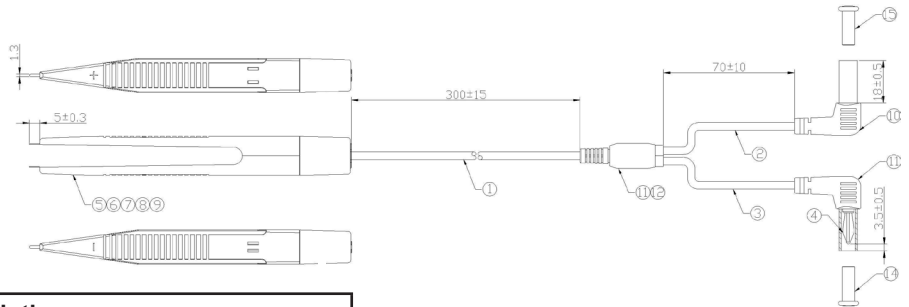

| No. | Description |
|-----|---|
| 1 | NOUL (10/0.12BC) × 2C BCBK01 OD:3.8mm PVC L=380mm |
| 2 | NOUL (20/0.12TC) + 1 × 1 BCRD01 OD:3.6mm PVC |
| 3 | NOUL (20/0.12TC) + 1 × 1 BCBK01 OD:3.6mm PVC |
| 4 | 19 + 5.5 × 9 + 2.5 × 20.1 |
| 5 | 0.4 × 122mm |
| 6 | ABS + |
| 7 | ABS - |
| 8 | ABS |
| 9 | 384 ABS UNI-T |
| 10 | PVC 60° 45P JLRD01 94V-2 65 FT2 |
| 11 | PVC 60° 45P JLBK01 94V-2 65 FT2 |
| 12 | ∅4 × 10 PVC |
| 13 | L=120mm |
| 14 | ∅4.8mm PE |
| 15 | ∅4.8mm PE |

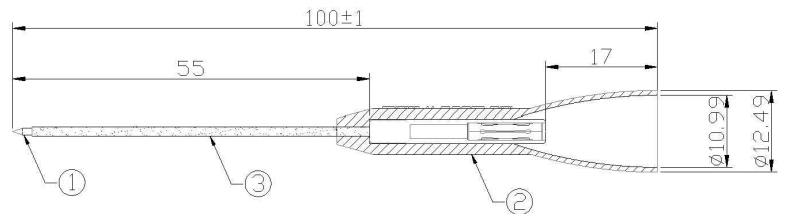
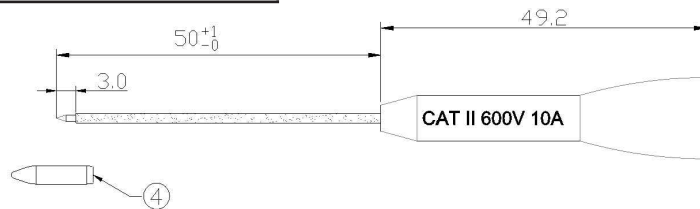
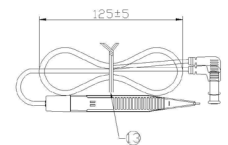

| No. | Description |
|-----|------------------------------|
| 1 | ∅4 × 27mm + ∅2mm + ∅1 × 61.2 |
| 2 | 1mm PA66 |
| 3 | ∅1 × 52mm |
| 4 | EC1.2-10 (0.6) |

Newark.com/multicomp-pro
 Farnell.com/multicomp-pro
 Element14.com/multicomp-pro

multicomp PRO

Test Leads Kit, 22 Piece **multicomp** PRO

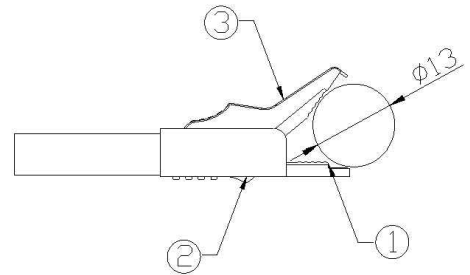
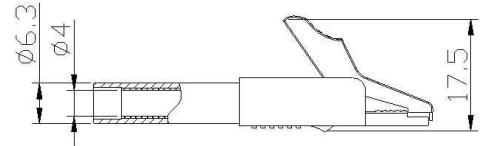
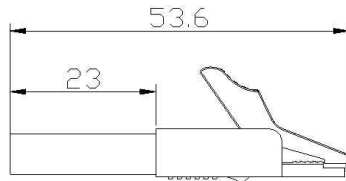

| No. | Description |
|-----|----------------------|
| 1 | A088 |
| 2 | A088 300V CATIII 15A |
| 3 | A088 |

Specification
30V AC/60V DC 10A

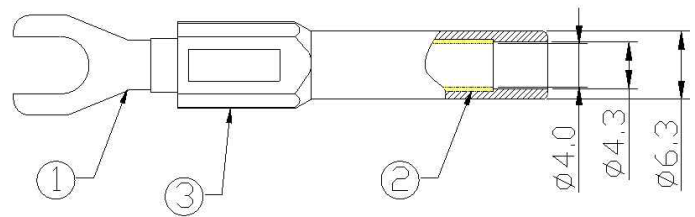
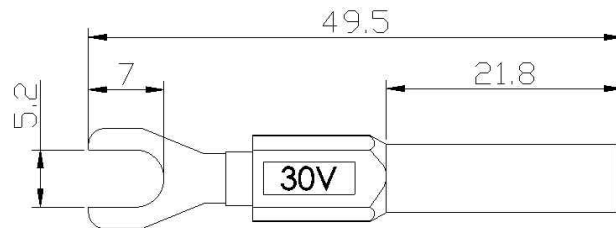

3.0±0.5MM

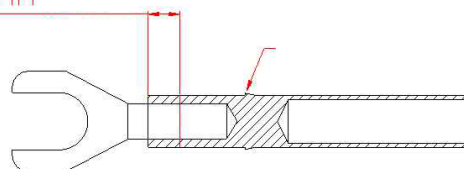

| No. | Description |
|-----|------------------|
| 1 | 0.8 × 20mm 5.2mm |
| 2 | ∅5.2 × 30mm, |
| 3 | PA66, 30V |

Newark.com/multicomp-pro
Farnell.com/multicomp-pro
Element14.com/multicomp-pro

multicomp PRO

Test Leads Kit, 22 Piece

multicomp PRO

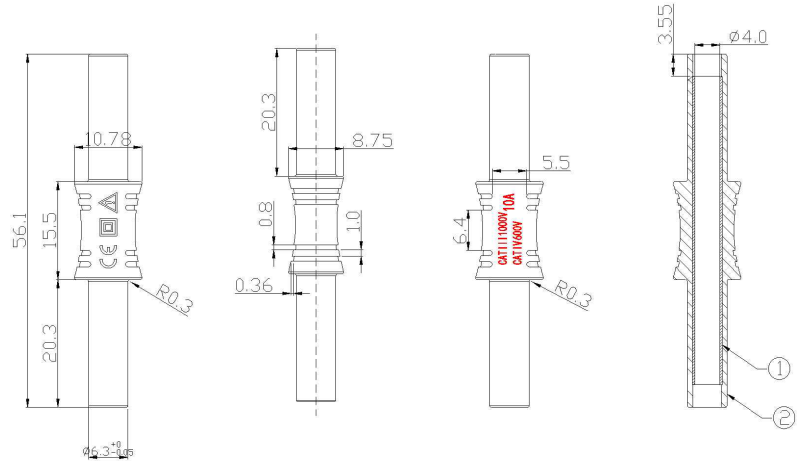
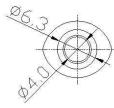

| No. | Description |
|-----|--------------------------|
| 1 | 4.8 × 4 × 49mm |
| 2 | PVC 60° 45P 94V-2 65 FT2 |
| 3 | PA66, 30V |

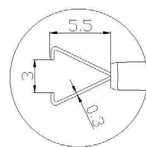

sec:1:2

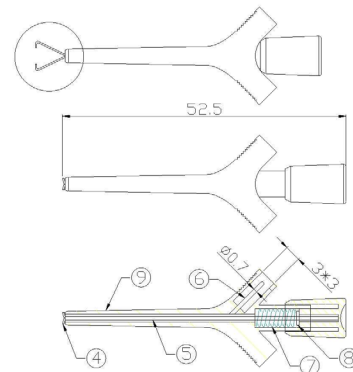

| No. | Description |
|-----|-----------------------|
| 1 | UL 1007 24AWG L=250mm |
| 2 | ∅4 × 27mm + ∅2mm |
| 3 | ∅4 × 35mm PVC |
| 4 | ∅0.3MM |
| 5 | ∅1.5 × 1 × 36.5mm |
| 6 | ∅1.5 × 10mm PIN |
| 7 | 0.35 × OD3.1H12N10 |
| 8 | ∅3.0 × 6.7mm 0.7mm |
| 9 | 101L PA66 3A |

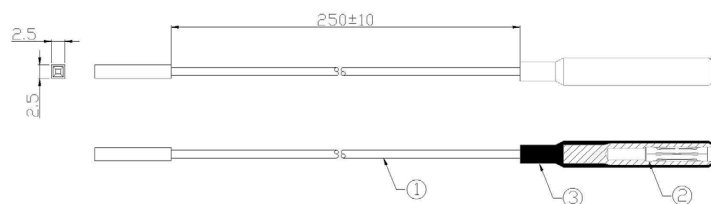

Dimensions : Millimetres

Part Number Table

| Description | Part Number |
|--------------------------|-------------|
| Test Leads Kit, 22 Piece | MP770739 |

Important Notice : This data sheet and its contents (the "Information") belong to the members of the AVNET group of companies (the "Group") or are licensed to it. No licence is granted for the use of it other than for information purposes in connection with the products to which it relates. No licence of any intellectual property rights is granted. The Information is subject to change without notice and replaces all data sheets previously supplied. The Information supplied is believed to be accurate but the Group assumes no responsibility for its accuracy or completeness, any error in or omission from it or for any use made of it. Users of this data sheet should check for themselves the Information and the suitability of the products for their purpose and not make any assumptions based on information included or omitted. Liability for loss or damage resulting from any reliance on the Information or use of it (including liability resulting from negligence or where the Group was aware of the possibility of such loss or damage arising) is excluded. This will not operate to limit or restrict the Group's liability for death or personal injury resulting from its negligence. Multicomp Pro is the registered trademark of Premier Farnell Limited 2019.

Newark.com/multicomp-pro
 Farnell.com/multicomp-pro
 Element14.com/multicomp-pro

multicomp PRO